

# Kingbright

## Optoelectronic Components

### TECHNICAL NOTES

SMD Tape Specifications	94
Recommended Soldering Pattern	103
Technical Data	108
Bin Code Systems	123
Application Notes	125
CIE chromaticity Diagram	129
Index	131

## SMD TAPE SPECIFICATIONS

Reel Dimensions	Part Number			Reel Dimensions	Part Number	Reel Dimensions	Part Number	
7" (for 8mm width tape)	KA-2214	KPG-1608	KPTF-1616	7" (for 12mm width tape)	KA-3022-4.5SF	13" (for 12mm width tape)	KA-3535	
	KA-2810A	KPG1-1608	KPTL-3216		KA3030		13" (for 24mm width tape)	KCDX02
	KA-3021	KPGA-1602	KPTR-3216		KA-3528			KCDX03
	KM-23-F	KPGF-0606			KA-3529A			KCSX02
	KM-23xxx	KPGF-1011			KA-4008	KCSX03		
	KP-1608	KPH-1608			KA-4040	KCSX04		
	KP-2012	KPHB-1608			KA-5630			
	KP-3216	KPHBM-2012			KAA-3528			
	KPA-1606	KPHCM-2012			KAA-3528-C8-CC			
	KPA-2107	KPHD-1608			KAAF-3529			
	KPA-3010	KPHHS-1005			KAAF-5050-13			
	KPA-3210	KPHM-1608			KM2520xxx03			
	KPB-3025	KPL-3015			KM2520xxx08			
	KPBA-3010	KPPA-3010			KM2520xxx09			
	KPBD-3224	KPS-3227SP1C			KPED-3528			
KPBDA-3020-PF	KPT-1608		KPS-5130PD7C					
KPBL-3025	KPT-2012		KTDS-3536					
KPC-1608	KPT-3216							
KPD-3224	KPTB-1612							
KPFA-2507	KPTB-1615							
KPFA-3010	KPTBD-3216							
KPFA-3011	KPTC-3212							
KPG-0603	KPTD-1608							
KPG-1005	KPTD-3216							
						13" (for 32mm width tape)		
						13" (for 44mm width tape)	KCDX56	

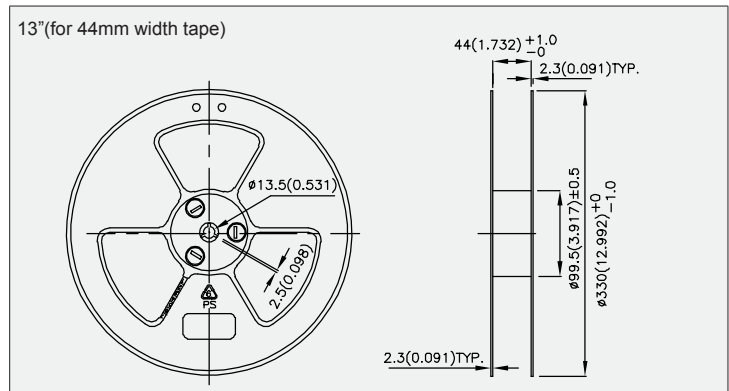
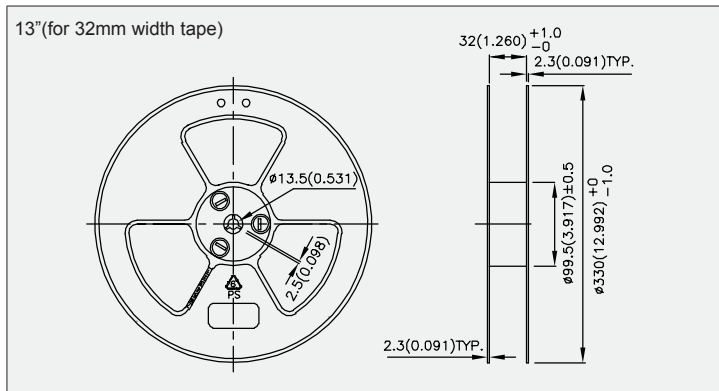
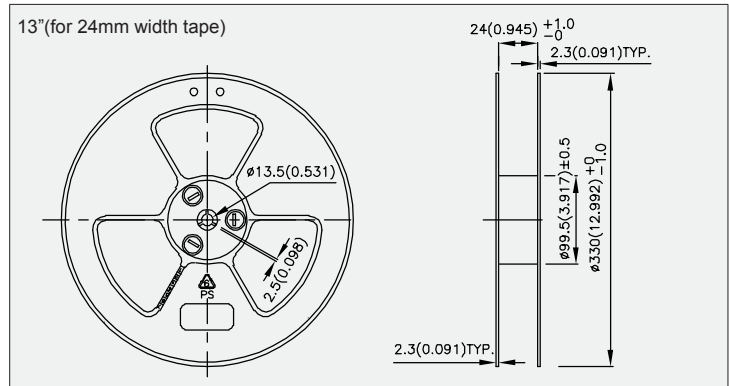
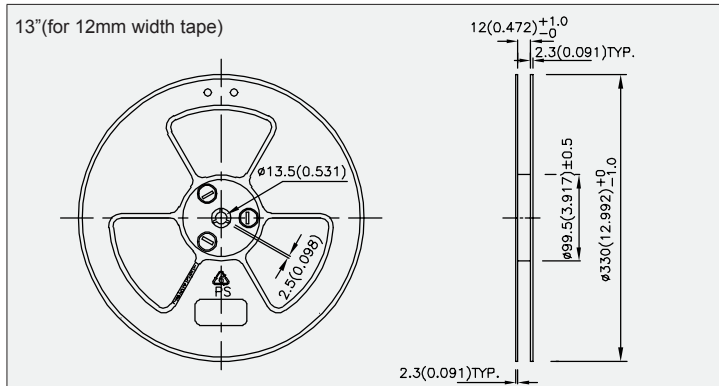
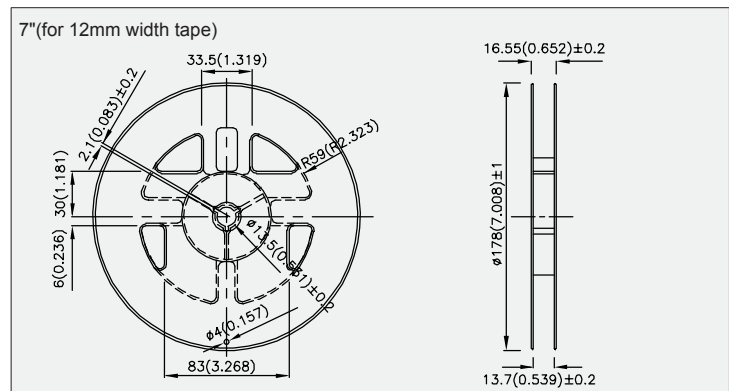
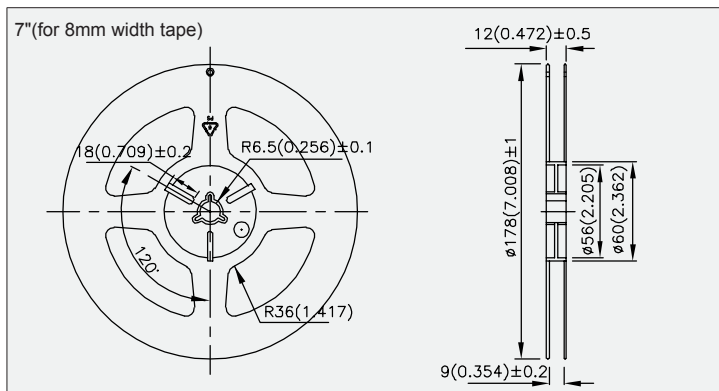

NOTE: 1. All dimensions are in millimeters(inches).

SMD TAPE SPECIFICATIONS

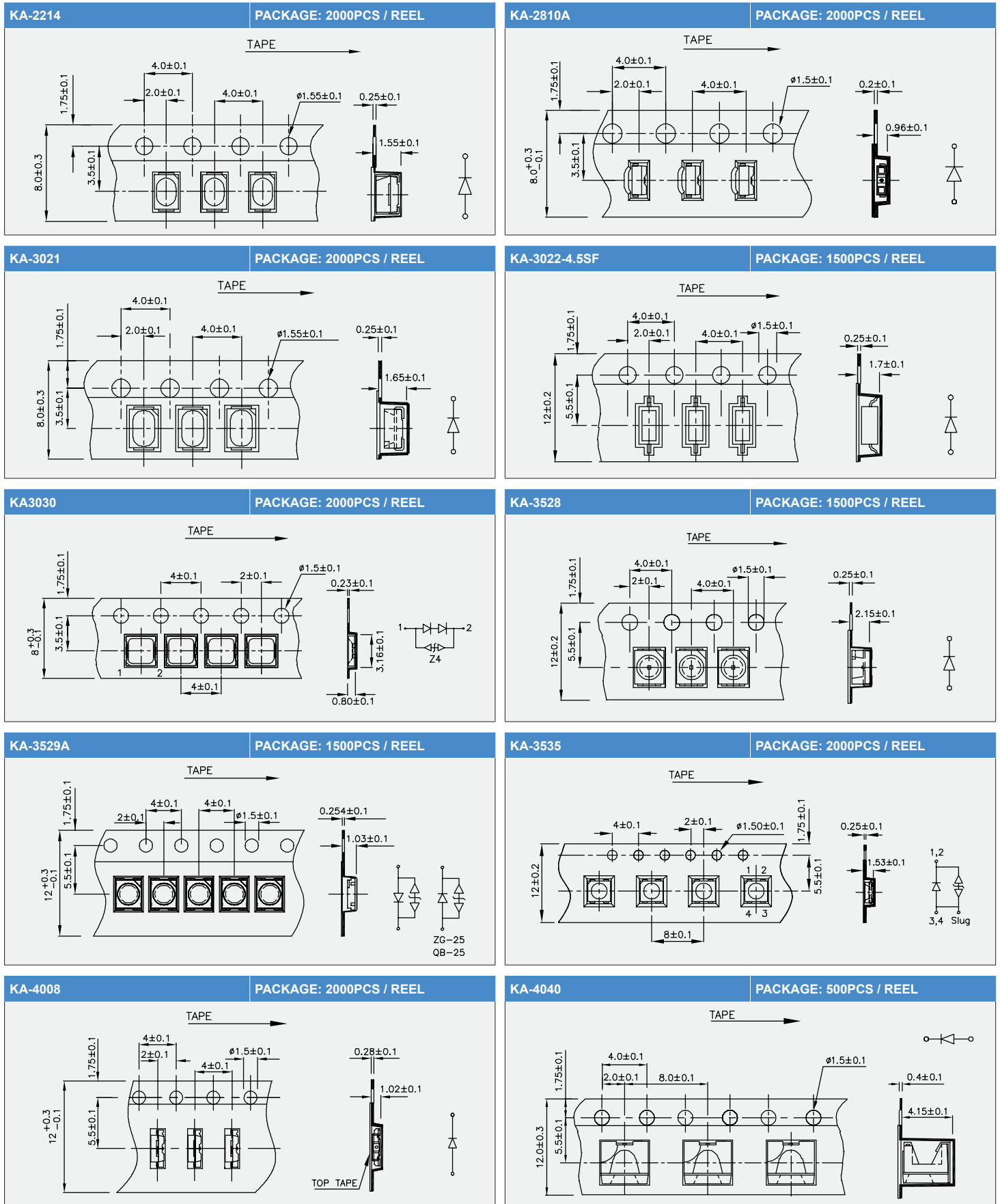

NOTE: 1. All dimensions are in millimeters.

## SMD TAPE SPECIFICATIONS

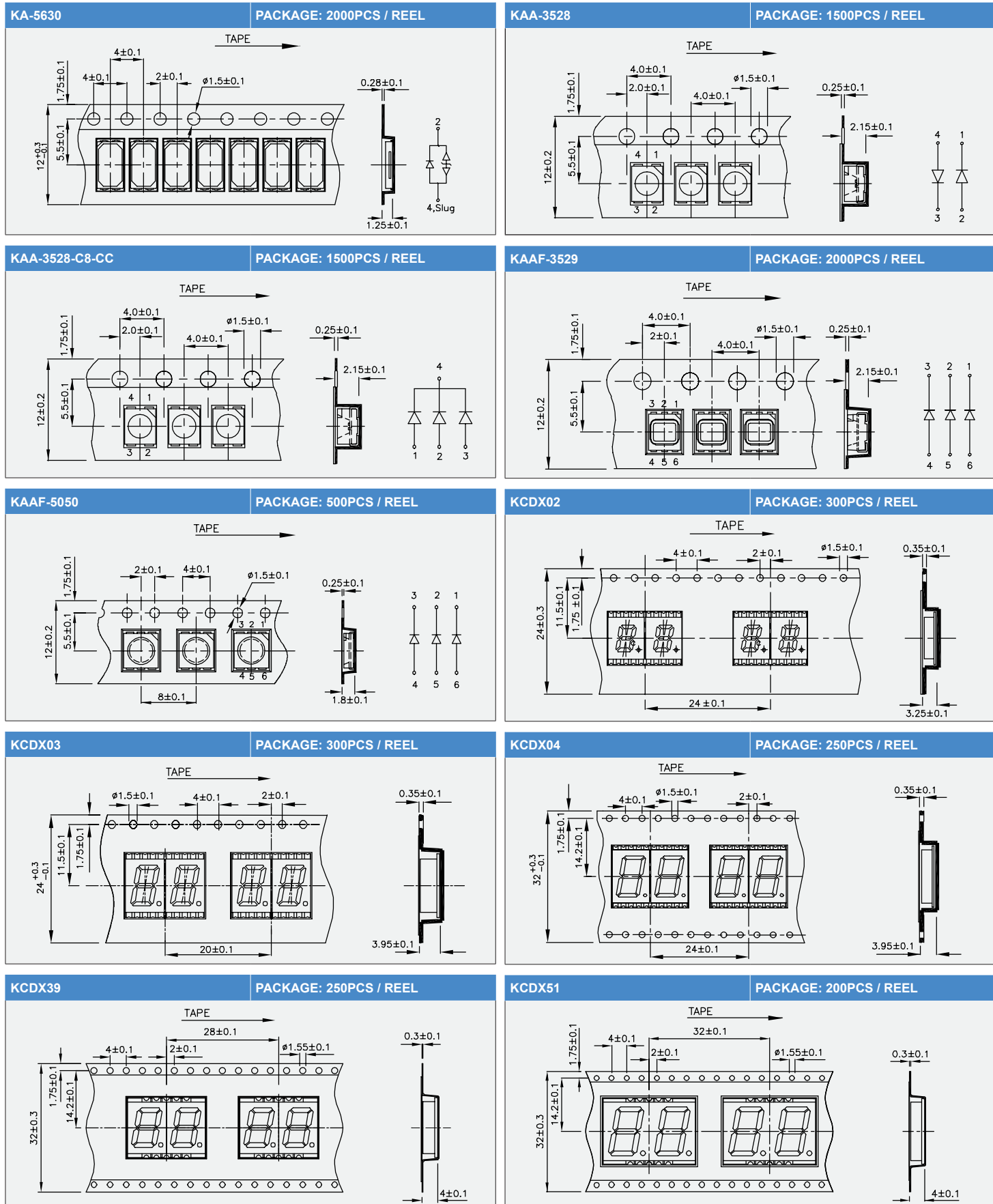

NOTE: 1. All dimensions are in millimeters.

## SMD TAPE SPECIFICATIONS

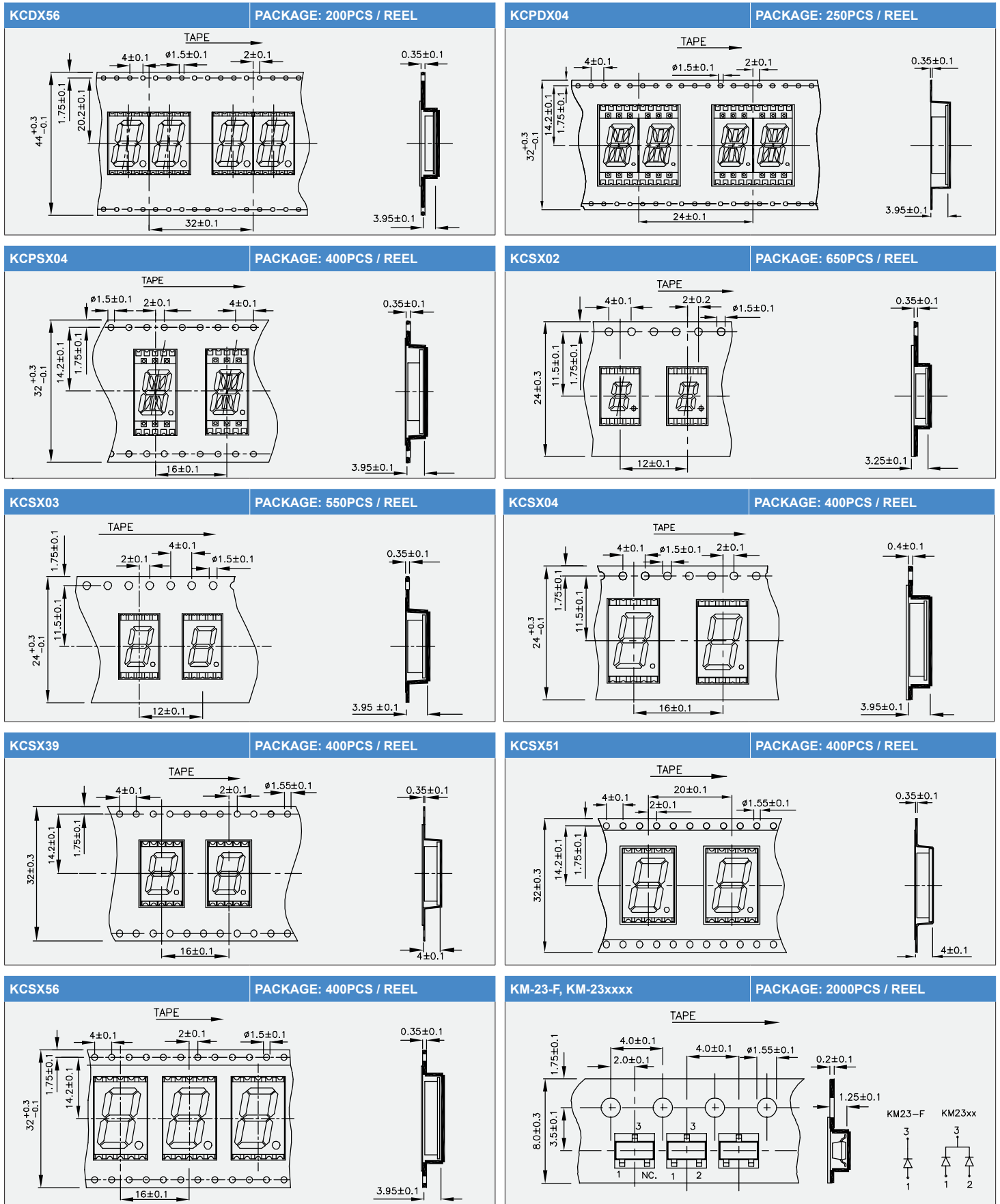

NOTE: 1. All dimensions are in millimeters.

## SMD TAPE SPECIFICATIONS

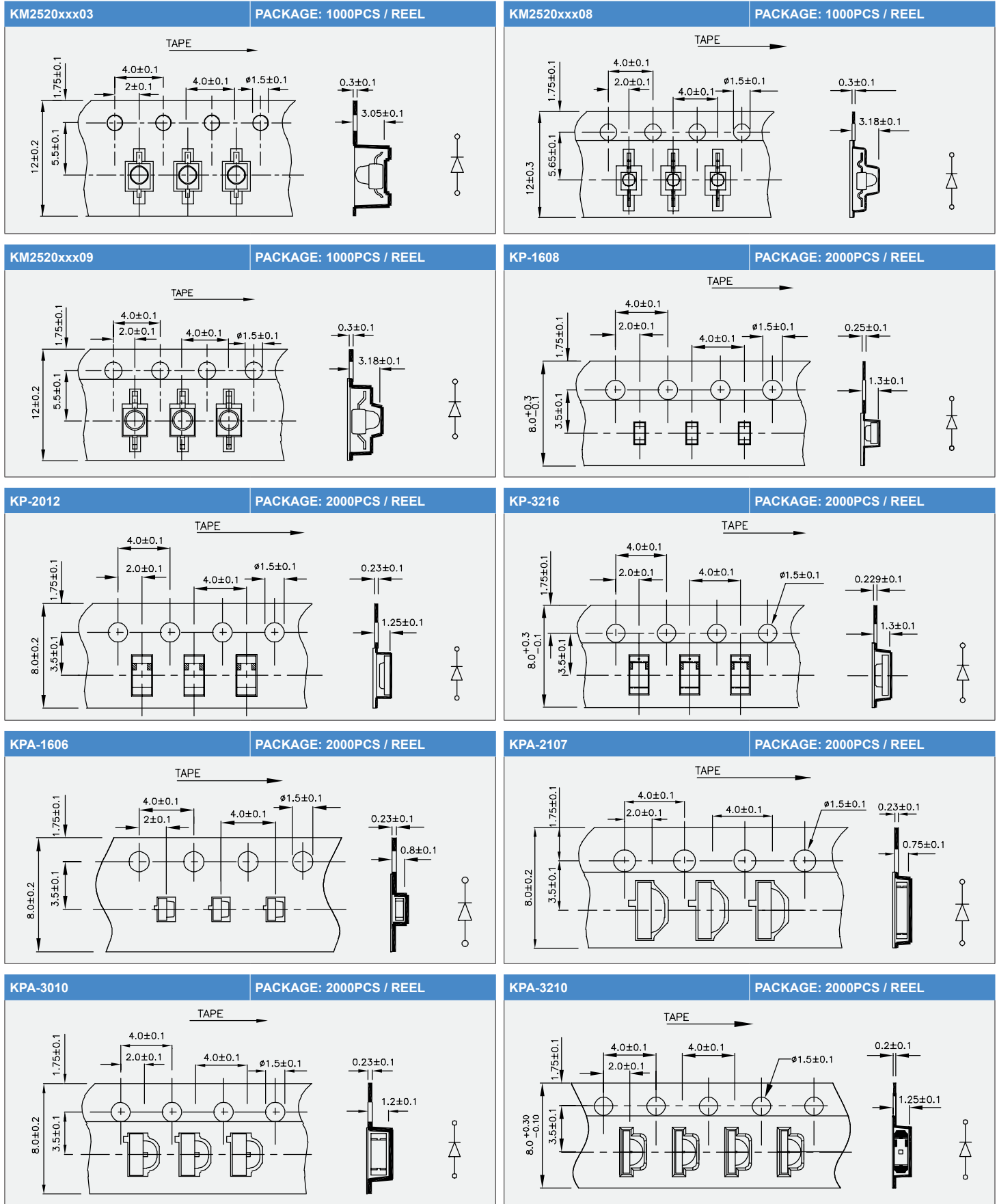

NOTE: 1. All dimensions are in millimeters.

SMD TAPE SPECIFICATIONS

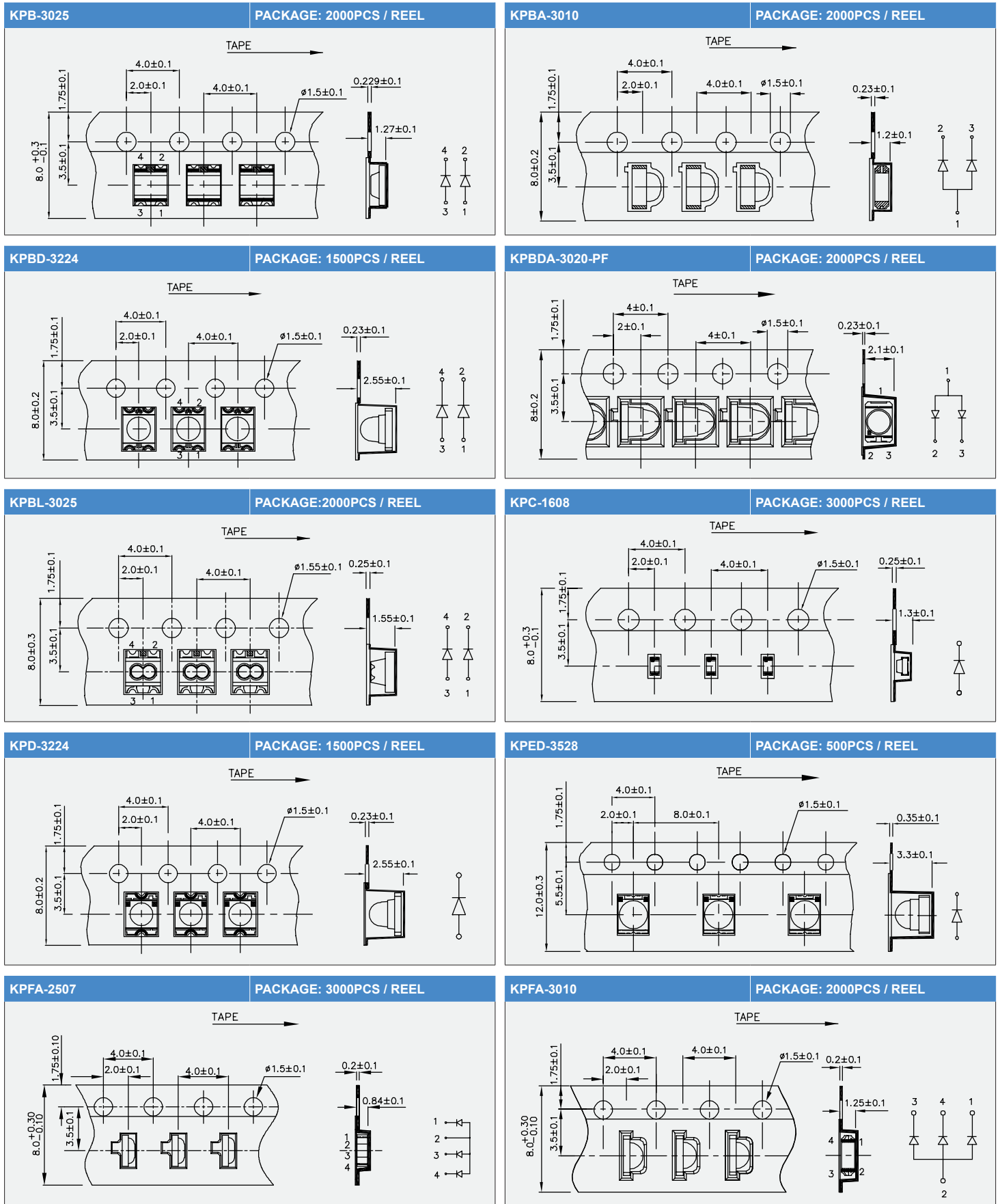

NOTE: 1. All dimensions are in millimeters.

## SMD TAPE SPECIFICATIONS

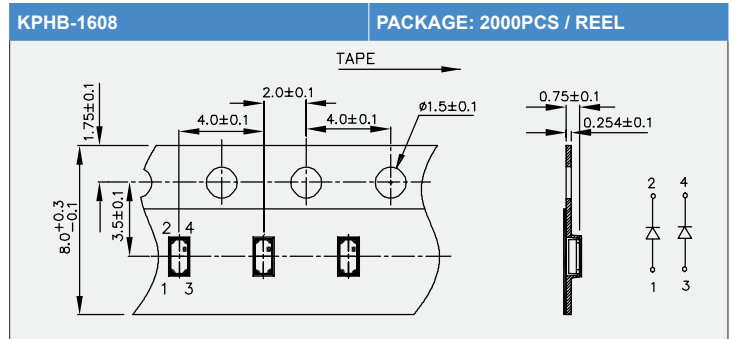
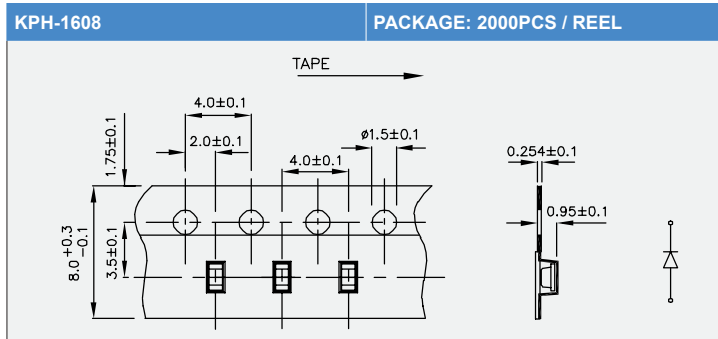
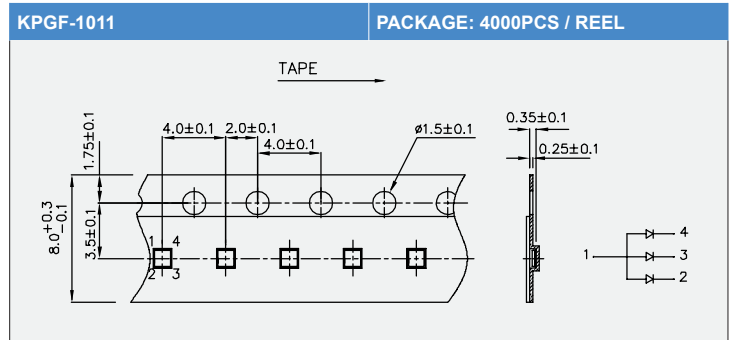
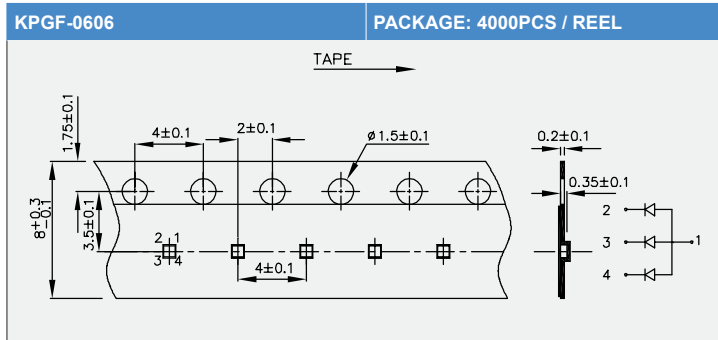
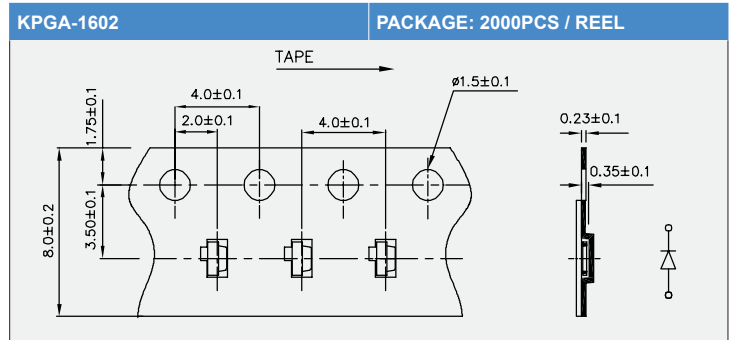
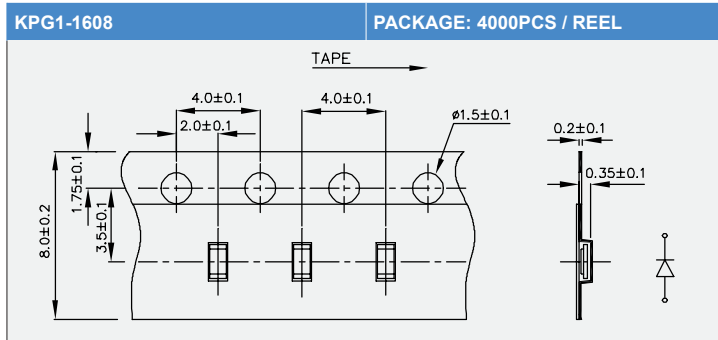
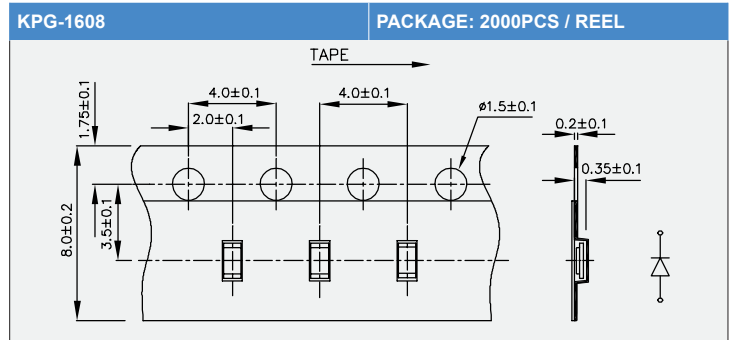
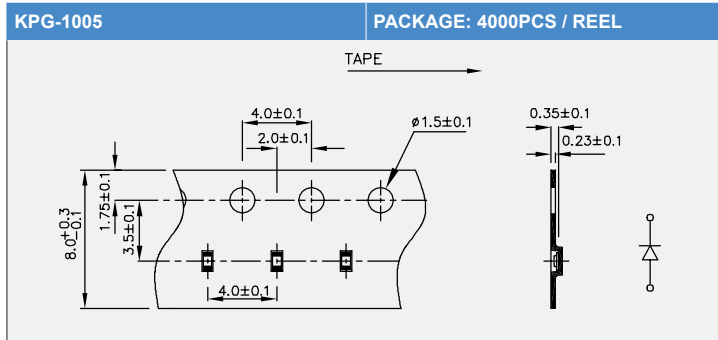
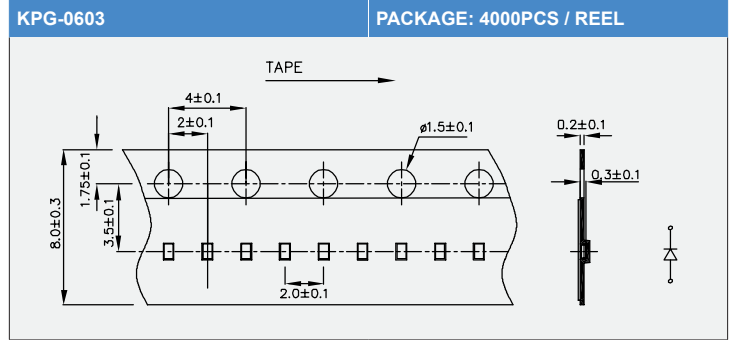
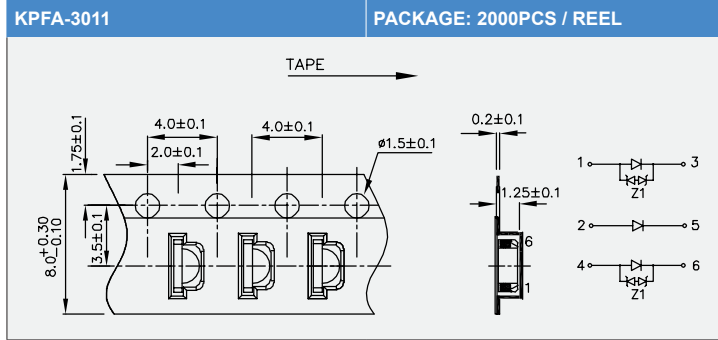



SMD TAPE SPECIFICATIONS

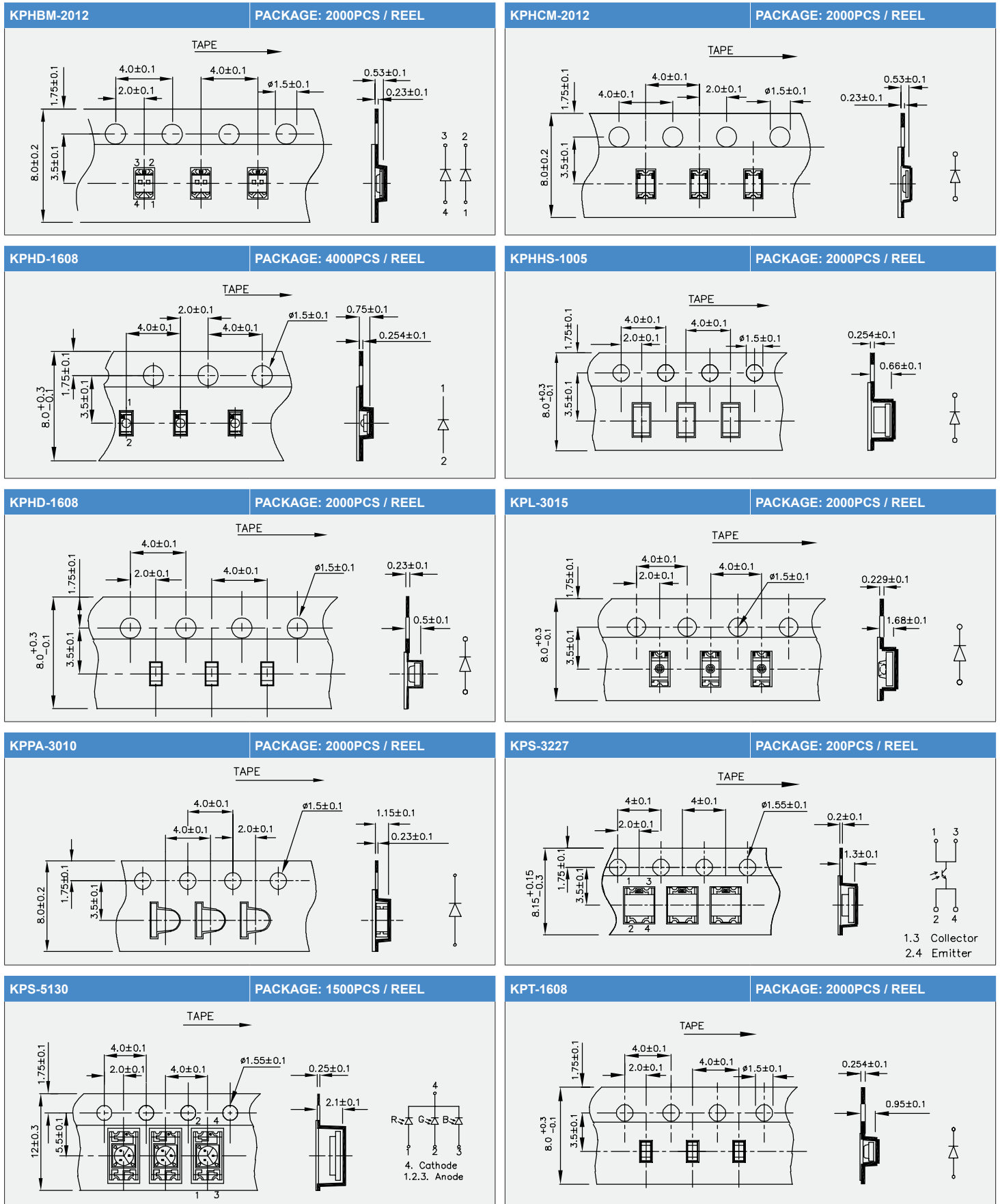

NOTE: 1. All dimensions are in millimeters.

## SMD TAPE SPECIFICATIONS

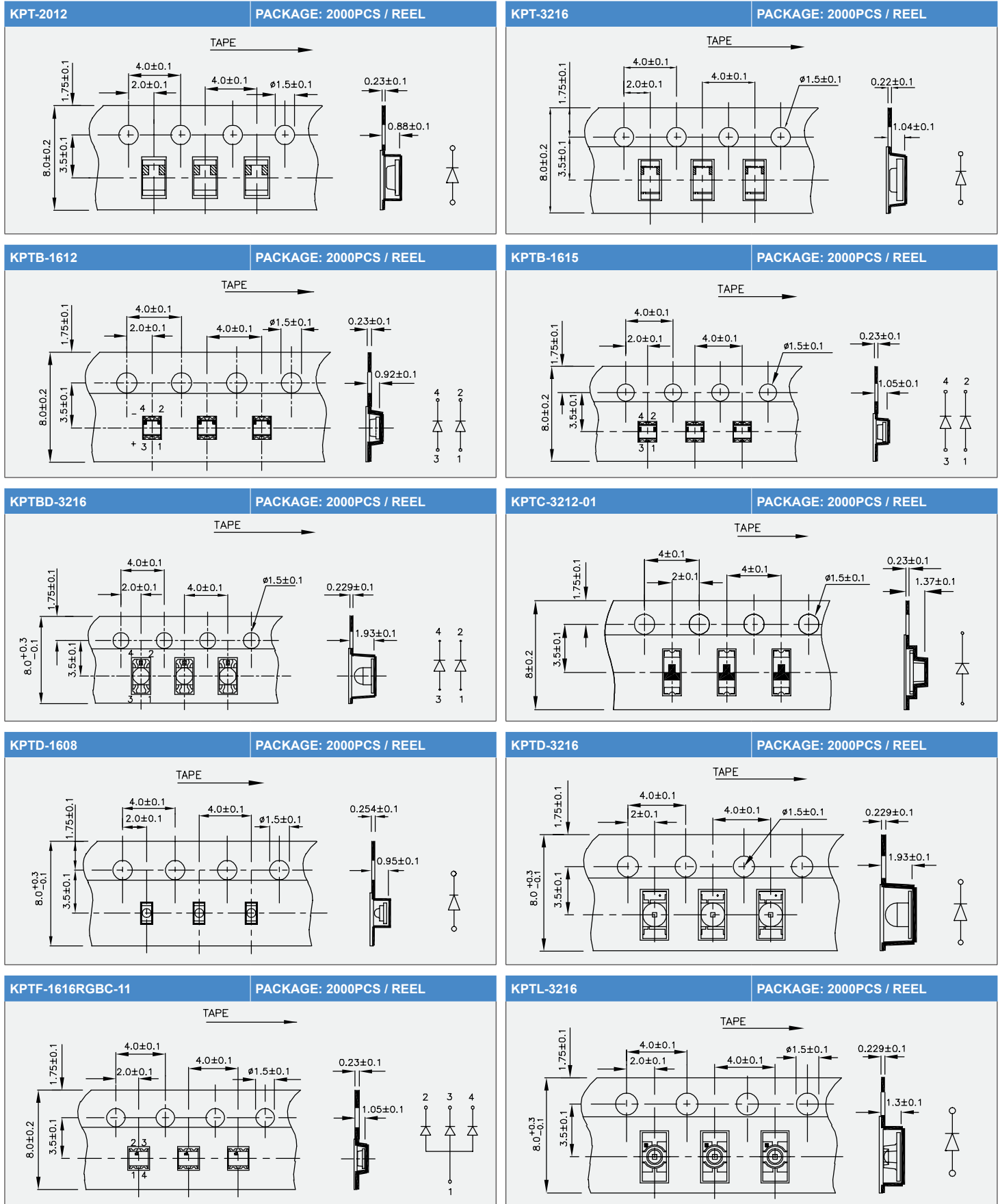

NOTE: 1. All dimensions are in millimeters.

SMD TAPE SPECIFICATIONS

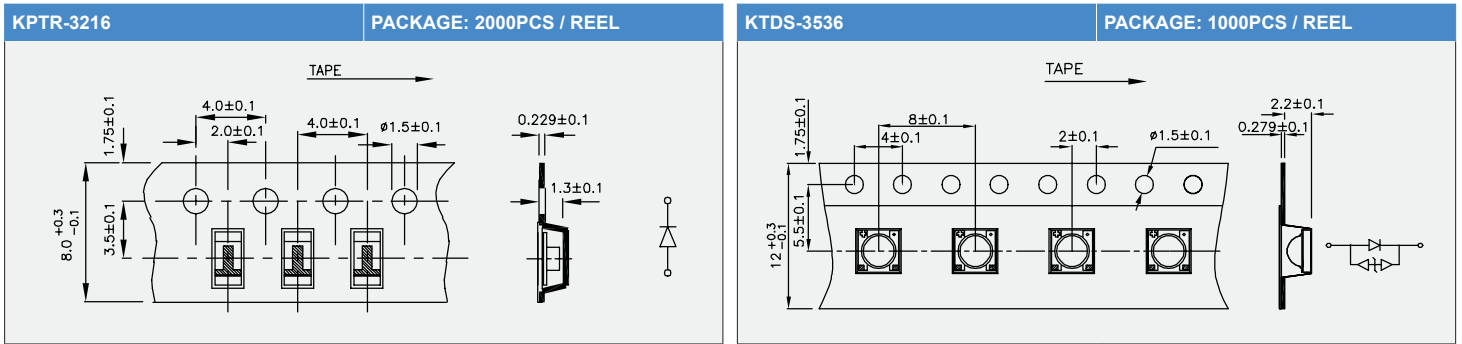

RECOMMENDED SOLDERING PATTERN

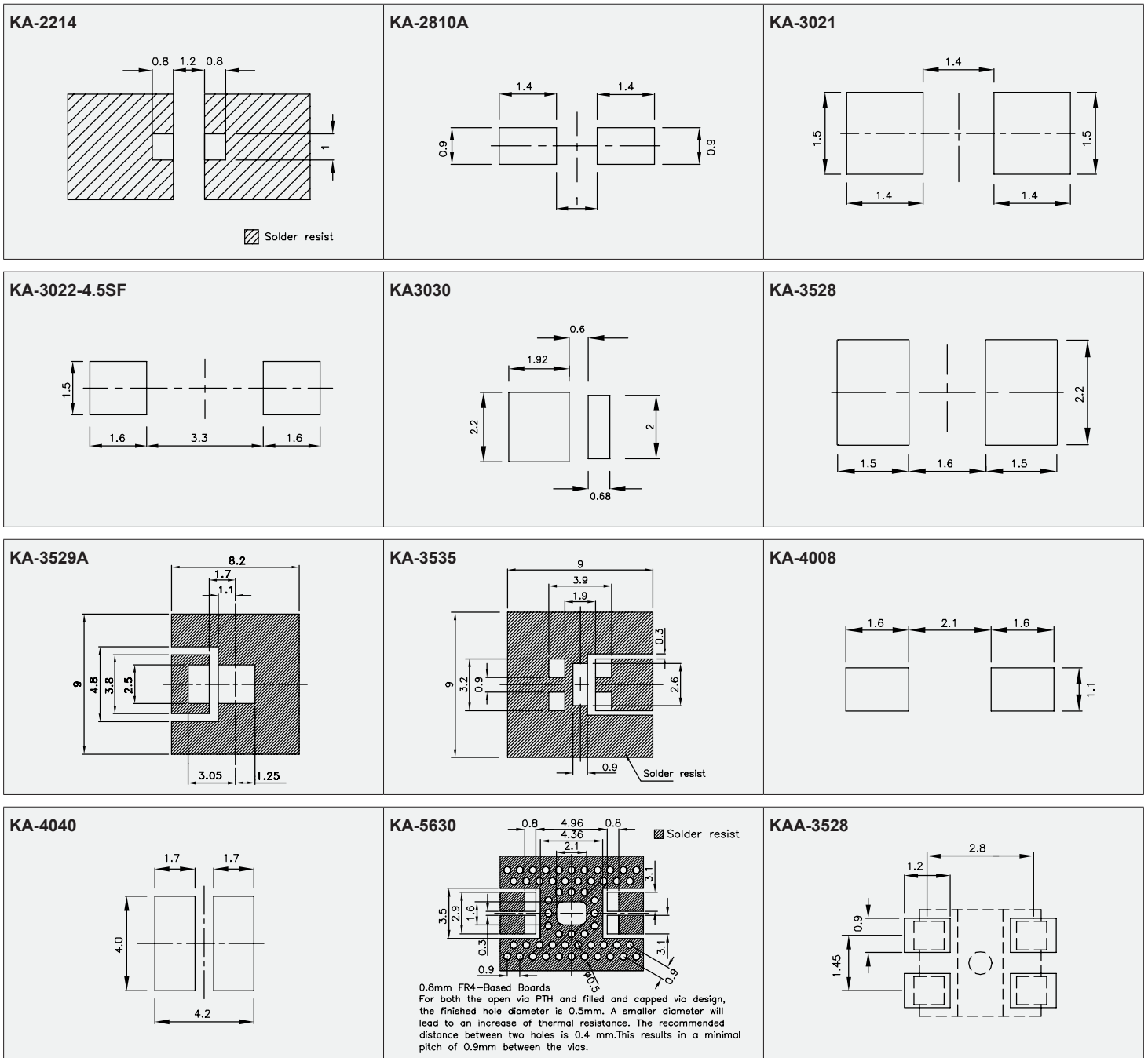

NOTES:  
 1. All dimensions are in millimeters.  
 2. Tolerance is ±0.1mm unless otherwise noted.

## RECOMMENDED SOLDERING PATTERN

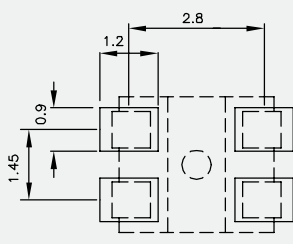
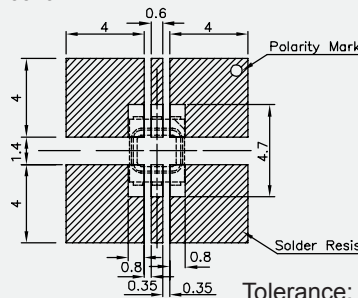
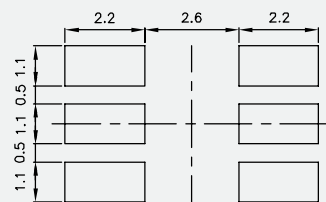
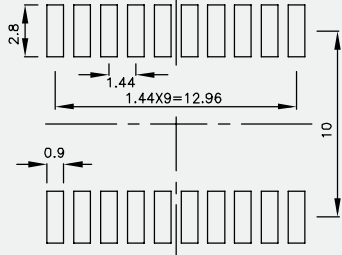
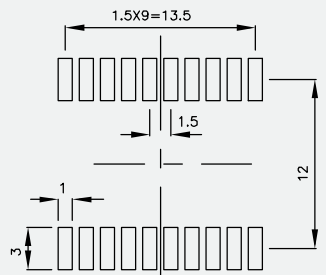
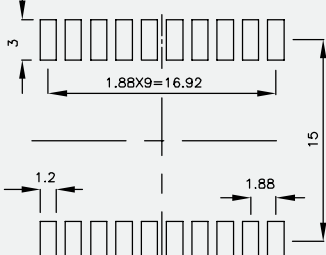
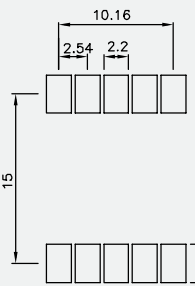
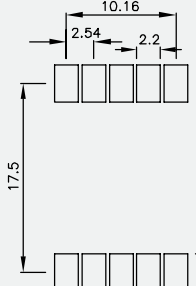
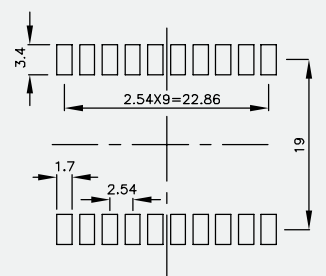
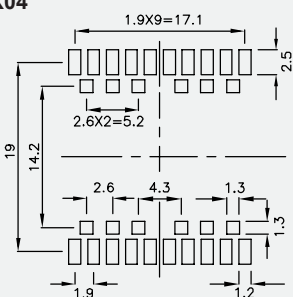
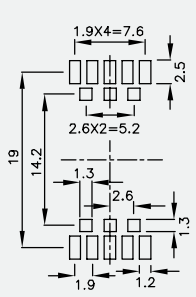
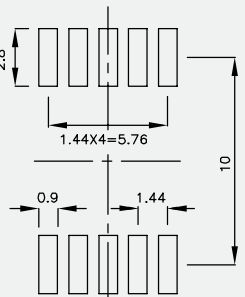
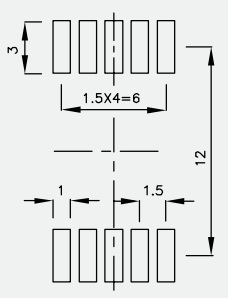
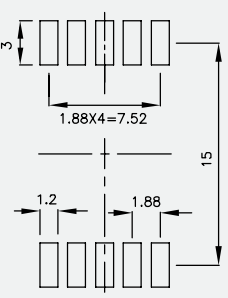
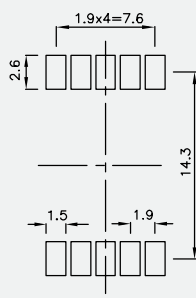
<p><b>KAA-3528</b></p>  <p>Tolerance: <math>\pm 0.1</math></p>	<p><b>KAAF-3529</b></p>  <p>Tolerance: <math>\pm 0.1</math></p>	<p><b>KAAF-5050</b></p>  <p>Tolerance: <math>\pm 0.1</math></p>
<p><b>KCDX02</b></p>  <p>Tolerance: <math>\pm 0.1</math></p>	<p><b>KCDX03</b></p>  <p>Tolerance: <math>\pm 0.1</math></p>	<p><b>KCDX04</b></p>  <p>Tolerance: <math>\pm 0.1</math></p>
<p><b>KCDX39</b></p>  <p>Tolerance: <math>\pm 0.1</math></p>	<p><b>KCDX51</b></p>  <p>Tolerance: <math>\pm 0.1</math></p>	<p><b>KCDX56</b></p>  <p>Tolerance: <math>\pm 0.1</math></p>
<p><b>KCPDX04</b></p>  <p>Tolerance: <math>\pm 0.1</math></p>	<p><b>KCPSX04</b></p>  <p>Tolerance: <math>\pm 0.1</math></p>	<p><b>KCSX02</b></p>  <p>Tolerance: <math>\pm 0.1</math></p>
<p><b>KCSX03</b></p>  <p>Tolerance: <math>\pm 0.1</math></p>	<p><b>KCSX04</b></p>  <p>Tolerance: <math>\pm 0.1</math></p>	<p><b>KCSX39</b></p>  <p>Tolerance: <math>\pm 0.1</math></p>

NOTES:  
 1. All dimensions are in millimeters.  
 2. Tolerance is  $\pm 0.15$ mm unless otherwise noted.

RECOMMENDED SOLDERING PATTERN

<p><b>KCSX51</b></p> <p>Tolerance: <math>\pm 0.15</math></p>	<p><b>KCSX56</b></p> <p>Tolerance: <math>\pm 0.15</math></p>	<p><b>KM-23-F, KM-23xxx</b></p>
<p><b>KM2520xxx03</b></p>	<p><b>KM2520xxx08</b></p>	<p><b>KM2520xxx09</b></p>
<p><b>KP-1608, KPC-1608, KPG-1608, KPH-1608, KPHM-1608, KPT-1608, KPTD-1608</b></p>	<p><b>KP-2012, KPT-2012</b></p>	<p><b>KP-3216, KPT-3216, KPTD-3216</b></p>
<p><b>KPA-1606</b></p>	<p><b>KPA-2107</b></p>	<p><b>KPA-3010, KPBA-3010</b></p>
<p><b>KPA-3210</b></p>	<p><b>KPB-3025, KPBL-3025</b></p>	<p><b>KPBD-3224</b></p>

NOTES:  
 1. All dimensions are in millimeters.  
 2. Tolerance is  $\pm 0.1\text{mm}$  unless otherwise noted.

## RECOMMENDED SOLDERING PATTERN

<p><b>KPBDA-3020-PF</b></p>	<p><b>KPD-3224</b></p>	<p><b>KPED-3528</b></p>
<p><b>KPFA-2507</b></p>	<p><b>KPFA-3010</b></p>	<p><b>KPFA-3011</b></p>
<p><b>KPG-0603</b></p>	<p><b>KPG-1005, KPHHS-1005</b></p>	<p><b>KPG1-1608</b></p>
<p><b>KPGA-1602</b></p>	<p><b>KPGF-0606</b></p>	<p><b>KPGF-1011</b></p>
<p><b>KPHB-1608</b></p>	<p><b>KPHBM-2012</b></p>	<p><b>KPHCM-2012</b></p>

NOTES:  
 1. All dimensions are in millimeters.  
 2. Tolerance is  $\pm 0.1\text{mm}$  unless otherwise noted.

RECOMMENDED SOLDERING PATTERN

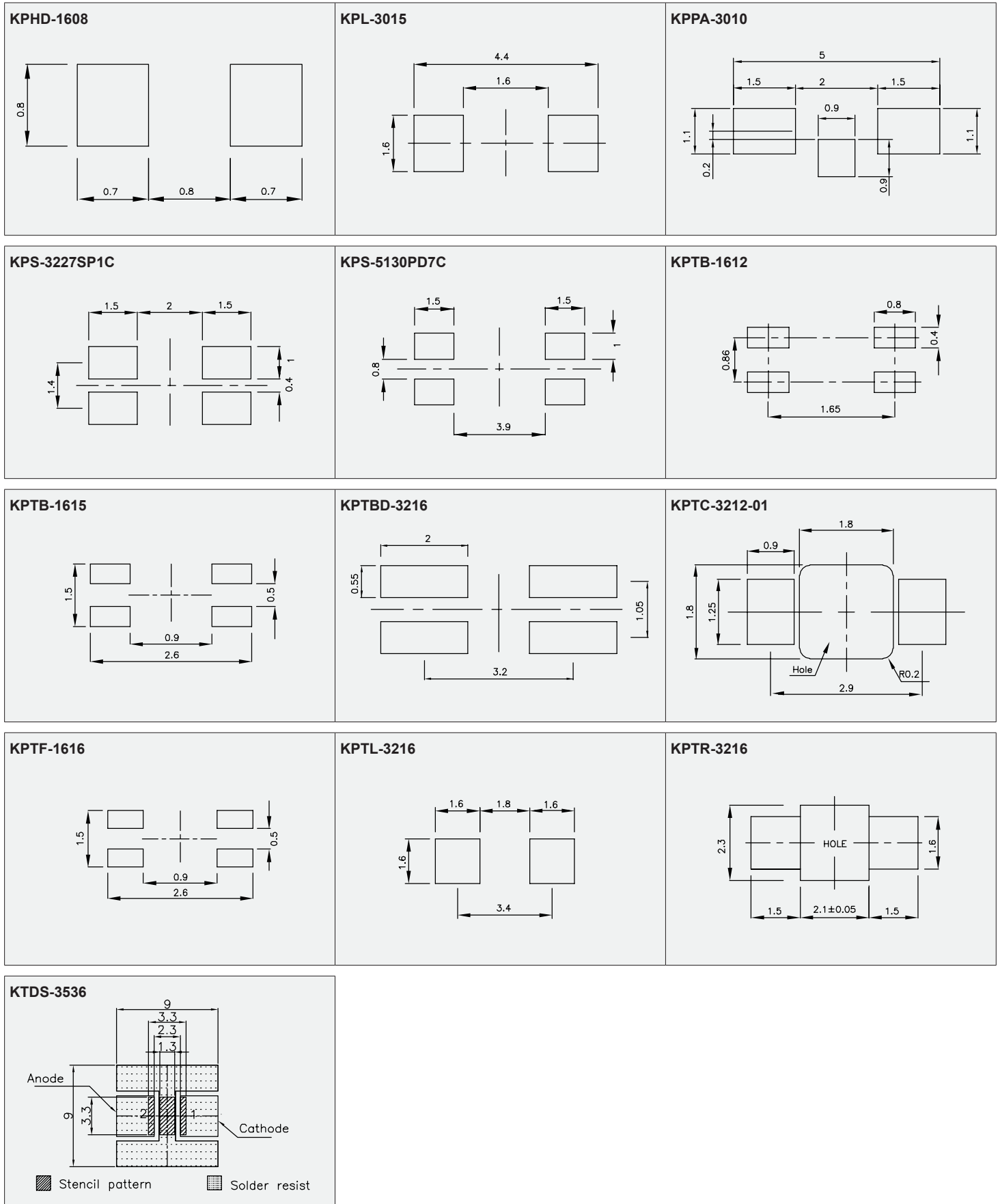

NOTES:

1. All dimensions are in millimeters.
2. Tolerance is  $\pm 0.1$ mm unless otherwise noted.

## TECHNICAL DATA

Absolute maximum ratings (T <sub>A</sub> =25°C)		E, I Hi.Eff.Red Orange  (GaAsP/GaP)	H Bright Red  (GaP)	SR Super Bright Red  (GaAlAs)	SR-J4 Super Bright Red  (AlGaInP)	SURK Hyper Red  (AlGaInP)	SURK-T Hyper Red  (AlGaInP)	SUR-E Hyper Red  (AlGaInP)	Unit
Reverse voltage	V <sub>R</sub>	● 5	● 5	● 5	● 5	● 5	● 5	● 5	V
Forward current	I <sub>F</sub>	30	25	30	30	30	30	30	mA
Forward current (Peak) 1/10 Duty Cycle, 0.1ms Pulse Width	I <sub>FS</sub>	160	130	155	150	185	150	200	mA
Power dissipation	P <sub>D</sub>	75	62.5	75	75	75	75	75	mW
<b>LED LAMPS:</b>									
Operating temperature	T <sub>A</sub>	-40~+85	-40~+85	-40~+85	-40~+85	-40~+85	-40~+85	-40~+85	°C
Storage temperature	T <sub>STG</sub>	-40~+85	-40~+85	-40~+85	-40~+85	-40~+85	-40~+85	-40~+85	°C
<b>LED DISPLAYS:</b>									
Operating temperature	T <sub>A</sub>	-40~+85	-40~+85	-40~+85	-40~+85	-40~+85	-40~+85	-40~+85	°C
Storage temperature	T <sub>STG</sub>	-40~+85	-40~+85	-40~+85	-40~+85	-40~+85	-40~+85	-40~+85	°C

Operating Characteristics		E, I Hi.Eff.Red Orange  (GaAsP/GaP)	H Bright Red  (GaP)	SR Super Bright Red  (GaAlAs)	SR-J4 Super Bright Red  (AlGaInP)	SURK Hyper Red  (AlGaInP)	SURK-T Hyper Red  (AlGaInP)	SUR-E Hyper Red  (AlGaInP)	Unit
Forward voltage (typ.) I <sub>F</sub> =20mA	V <sub>F</sub>	● 2.0	● 2.25	● 1.85	● 2.1	● 1.95	● 2.0	● 1.9	V
I <sub>F</sub> =10mA		1.9	2.05	1.8	1.8	1.85	1.85	1.8	
I <sub>F</sub> =2mA		1.7	1.85	1.65	1.65	1.75	1.75	1.7	
Forward voltage (max.) I <sub>F</sub> =20mA, 10mA, 2mA	V <sub>F</sub>	2.5	2.5	2.5	2.5	2.5	2.5	2.5	V
Reverse current V <sub>R</sub> =5V	I <sub>R</sub>	10	10	10	10	10	10	10	μA
Peak Emission Wavelength I <sub>F</sub> =20mA, 10mA, 2mA	λ <sub>P</sub>	627	700	655	660	645	645	645	nm
Dominant Wavelength I <sub>F</sub> =20mA, 10mA, 2mA	λ <sub>D</sub>	617	635	640	640	630	630	630	nm
Spectral line half-width I <sub>F</sub> =20mA, 10mA, 2mA	Δλ <sub>1/2</sub>	45	45	20	20	28	20	25	nm
Capacitance V <sub>F</sub> =0V, f=1MHZ	C	15	40	45	45	35	35	45	pF



TECHNICAL DATA

Absolute maximum ratings (T <sub>A</sub> =25°C)		SUR-G Hyper Red  (AlGaInP)	SE-J3-K Hyper Red  (AlGaInP)	SE-J3 Hyper Red  (AlGaInP)	SE-E Hyper Red  (AlGaInP)	SE-H Hyper Red  (AlGaInP)	SE-J4-K Super Bright Orange  (AlGaInP)	SE-J4 Super Bright Orange  (AlGaInP)	N Pure Orange  (GaAsP/GaP)	Unit
Reverse voltage	V <sub>R</sub>	●	●	●	●	●	●	●	●	V
Forward current	I <sub>F</sub>	30	30	30	30	30	30	30	25	mA
Forward current (Peak) 1/10 Duty Cycle, 0.1ms Pulse Width	i <sub>FS</sub>	150	150	150	195	150	150	150	145	mA
Power dissipation	P <sub>D</sub>	75	84	84	75	84	84	84	62.5	mW
<b>LED LAMPS:</b>										
Operating temperature	T <sub>A</sub>	-40~+85	-40~+85	-40~+85	-40~+85	-40~+85	-40~+85	-40~+85	-40~+85	°C
Storage temperature	T <sub>STG</sub>	-40~+85	-40~+85	-40~+85	-40~+85	-40~+85	-40~+85	-40~+85	-40~+85	°C
<b>LED DISPLAYS:</b>										
Operating temperature	T <sub>A</sub>	-40~+85	-40~+85	-40~+85	-40~+85	-40~+85	-40~+85	-40~+85	-40~+85	°C
Storage temperature	T <sub>STG</sub>	-40~+85	-40~+85	-40~+85	-40~+85	-40~+85	-40~+85	-40~+85	-40~+85	°C

Operating Characteristics		SUR-G Hyper Red  (AlGaInP)	SE-J3-K Hyper Red  (AlGaInP)	SE-J3 Hyper Red  (AlGaInP)	SE-E Hyper Red  (AlGaInP)	SE-H Hyper Red  (AlGaInP)	SE-J4-K Super Bright Orange  (AlGaInP)	SE-J4 Super Bright Orange  (AlGaInP)	N Pure Orange  (GaAsP/GaP)	Unit
Forward voltage (typ.) I <sub>F</sub> =20mA		●	●	●	●	●	●	●	●	
I <sub>F</sub> =10mA	V <sub>F</sub>	1.9	2.2	2.2	2.0	2.2	2.2	2.2	2.05	V
I <sub>F</sub> =2mA		1.85	2.0	2.0	1.9	2.05	2.0	2.0	1.95	
Forward voltage (max.) I <sub>F</sub> =20mA, 10mA, 2mA	V <sub>F</sub>	1.75	1.8	1.8	1.8	1.85	1.8	1.8	1.85	V
Reverse current V <sub>R</sub> =5V	I <sub>R</sub>	2.5	2.8	2.8	2.5	2.8	2.8	2.8	2.5	uA
Peak Emission Wavelength I <sub>F</sub> =20mA, 10mA, 2mA	λ <sub>P</sub>	10	10	10	10	10	10	10	10	nm
Dominant Wavelength I <sub>F</sub> =20mA, 10mA, 2mA	λ <sub>D</sub>	645	640	640	630	635	611	611	607	nm
Spectral line half-width I <sub>F</sub> =20mA, 10mA, 2mA	Δλ <sub>1/2</sub>	630	625	625	621	625	605	605	602	nm
Capacitance V <sub>F</sub> =0V, f=1MHZ	C	22	20	25	20	25	17	17	35	pF

## TECHNICAL DATA

Absolute maximum ratings (T <sub>A</sub> =25°C)		SEK Super Bright Orange  (AlGaInP)	SEK-T Super Bright Orange  (AlGaInP)	G,SG Green, Super Bright Green  (GaP)	CGK Green  (AlGaInP)	CGK-T Green  (AlGaInP)	ZG-K Green  (InGaN)	ZG Green  (InGaN)	Unit
Reverse voltage	V <sub>R</sub>	●	●	●	●	●	●	●	V
Forward current	I <sub>F</sub>	30	30	25	30	30	25	25	mA
Forward current (Peak) 1/10 Duty Cycle, 0.1ms Pulse Width	i <sub>FS</sub>	195	150	140	150	150	150	150	mA
Power dissipation	P <sub>D</sub>	75	75	62.5	75	78	102.5	102.5	mW
<b>LED LAMPS:</b>									
Operating temperature	T <sub>A</sub>	-40~+85	-40~+85	-40~+85	-40~+85	-40~+85	-40~+85	-40~+85	°C
Storage temperature	T <sub>STG</sub>	-40~+85	-40~+85	-40~+85	-40~+85	-40~+85	-40~+85	-40~+85	°C
<b>LED DISPLAYS:</b>									
Operating temperature	T <sub>A</sub>	-40~+85	-40~+85	-40~+85	-40~+85	-40~+85	-40~+85	-40~+85	°C
Storage temperature	T <sub>STG</sub>	-40~+85	-40~+85	-40~+85	-40~+85	-40~+85	-40~+85	-40~+85	°C

Operating Characteristics		SEK Super Bright Orange  (AlGaInP)	SEK-T Super Bright Orange  (AlGaInP)	G,SG Green, Super Bright Green  (GaP)	CGK Green  (AlGaInP)	CGK-T Green  (AlGaInP)	ZG-K Green  (InGaN)	ZG Green  (InGaN)	Unit
Forward voltage (typ.) I <sub>F</sub> =20mA	V <sub>F</sub>	●	●	●	●	●	●	●	V
I <sub>F</sub> =10mA		2.1	2.05	2.2	2.1	2.1	3.3	3.3	
I <sub>F</sub> =2mA		2.0	1.95	2.0	2.0	1.95	3.0	3.0	
Forward voltage (max.) I <sub>F</sub> =20mA, 10mA, 2mA	V <sub>F</sub>	1.85	1.8	1.9	1.9	1.8	2.65	2.65	V
Reverse current V <sub>R</sub> =5V	I <sub>R</sub>	2.5	2.5	2.5	2.5	2.6	4.1	4.1	
Peak Emission Wavelength I <sub>F</sub> =20mA, 10mA, 2mA	λ <sub>P</sub>	10	10	10	10	10	50	50	μA
Dominant Wavelength I <sub>F</sub> =20mA, 10mA, 2mA	λ <sub>D</sub>	610	610	565	574	574	515	515	nm
Spectral line half-width I <sub>F</sub> =20mA, 10mA, 2mA	Δλ <sub>1/2</sub>	601	601	568	570	570	525	525	nm
Capacitance V <sub>F</sub> =0V, f=1MHZ	C	29	17	30	20	15	35	30	nm
		15	15	15	15	15	45	45	pF

TECHNICAL DATA

Absolute maximum ratings (T <sub>A</sub> =25°C)		ZG-E Green  (InGaN)	ZG-G Green  (InGaN)	Y Yellow  (GaAsP/GaP)	SYK Super Bright Yellow  (AlGaInP)	SYK-T Super Bright Yellow  (AlGaInP)	SY Super Bright Yellow  (AlGaInP)	SY-H Super Bright Yellow  (AlGaInP)	Unit
Reverse voltage	V <sub>R</sub>	5	5	5	5	5	5	5	V
Forward current	I <sub>F</sub>	30	30	30	30	30	30	30	mA
Forward current (Peak) 1/10 Duty Cycle, 0.1ms Pulse Width	i <sub>FS</sub>	100	100	140	175	150	150	140	mA
Power dissipation	P <sub>D</sub>	120	120	75	75	75	75	84	mW
<b>LED LAMPS:</b>									
Operating temperature	T <sub>A</sub>	-40~+85	-40~+85	-40~+85	-40~+85	-40~+85	-40~+85	-40~+85	°C
Storage temperature	T <sub>STG</sub>	-40~+85	-40~+85	-40~+85	-40~+85	-40~+85	-40~+85	-40~+85	°C
<b>LED DISPLAYS:</b>									
Operating temperature	T <sub>A</sub>	-40~+85	-40~+85	-40~+85	-40~+85	-40~+85	-40~+85	-40~+85	°C
Storage temperature	T <sub>STG</sub>	-40~+85	-40~+85	-40~+85	-40~+85	-40~+85	-40~+85	-40~+85	°C

Operating Characteristics		ZG-E Green  (InGaN)	ZG-G Green  (InGaN)	Y Yellow  (GaAsP/GaP)	SYK Super Bright Yellow  (AlGaInP)	SYK-T Super Bright Yellow  (AlGaInP)	SY Super Bright Yellow  (AlGaInP)	SY-H Super Bright Yellow  (AlGaInP)	Unit
Forward voltage (typ.) I <sub>F</sub> =20mA		3.2	3.2	2.1	2.0	2.05	2.0	2.3	
I <sub>F</sub> =10mA	V <sub>F</sub>	3.05	3.05	1.95	1.95	1.95	1.95	2.2	V
I <sub>F</sub> =2mA		2.8	2.8	1.85	1.85	1.8	1.8	2	
Forward voltage (max.) I <sub>F</sub> =20mA, 10mA, 2mA	V <sub>F</sub>	4.0	4.0	2.5	2.5	2.5	2.5	2.8	V
Reverse current V <sub>R</sub> =5V	I <sub>R</sub>	50	50	10	10	10	10	10	uA
Peak Emission Wavelength I <sub>F</sub> =20mA, 10mA, 2mA	λ <sub>P</sub>	520	520	590	590	590	590	590	nm
Dominant Wavelength I <sub>F</sub> =20mA, 10mA, 2mA	λ <sub>D</sub>	525	525	588	590	590	590	589	nm
Spectral line half-width I <sub>F</sub> =20mA, 10mA, 2mA	Δλ <sub>1/2</sub>	35	35	35	20	15	28	20	nm
Capacitance V <sub>F</sub> =0V, f=1MHZ	C	100	100	20	20	25	25	45	pF

## TECHNICAL DATA

Absolute maximum ratings (T <sub>A</sub> =25°C)		SY-J3-K Super Bright Yellow	SY-J3 Super Bright Yellow	MB Blue	PB-A Blue	QB-D Blue	QB-F Blue	QB-G Blue	VB-D Blue	Unit
		(AlGaInP)	(AlGaInP)	(GaN)	(InGaN)	(InGaN)	(InGaN)	(InGaN)	(InGaN)	
Reverse voltage	V <sub>R</sub>	5	5	5	5	5	5	5	5	V
Forward current	I <sub>F</sub>	30	30	30	30	30	30	30	30	mA
Forward current (Peak) 1/10 Duty Cycle, 0.1ms Pulse Width	I <sub>FS</sub>	140	140	150	100	150	150	150	100	mA
Power dissipation	P <sub>D</sub>	75	75	135	120	120	120	120	120	mW
LED LAMPS:										
Operating temperature	T <sub>A</sub>	-40~+85	-40~+85	-40~+85	-40~+85	-40~+85	-40~+85	-40~+85	-40~+85	°C
Storage temperature	T <sub>STG</sub>	-40~+85	-40~+85	-40~+85	-40~+85	-40~+85	-40~+85	-40~+85	-40~+85	°C
LED DISPLAYS:										
Operating temperature	T <sub>A</sub>	-40~+85	-40~+85	-40~+85	-40~+85	-40~+85	-40~+85	-40~+85	-40~+85	°C
Storage temperature	T <sub>STG</sub>	-40~+85	-40~+85	-40~+85	-40~+85	-40~+85	-40~+85	-40~+85	-40~+85	°C

Operating Characteristics		SY-J3-K Super Bright Yellow	SY-J3 Super Bright Yellow	MB Blue	PB-A Blue	QB-D Blue	QB-F Blue	QB-G Blue	VB-D Blue	Unit
		(AlGaInP)	(AlGaInP)	(GaN)	(InGaN)	(InGaN)	(InGaN)	(InGaN)	(InGaN)	
Forward voltage (typ.) I <sub>F</sub> =20mA	V <sub>F</sub>	2.0	2.0	3.8	3.2	3.3	3.3	3.3	3.3	V
I <sub>F</sub> =10mA		1.95	1.95	3.6	3.05	3.0	3.0	3.0	3.0	
I <sub>F</sub> =2mA		1.85	1.85	3.4	2.8	2.65	2.65	2.65	2.65	
Forward voltage (max.) I <sub>F</sub> =20mA, 10mA, 2mA	V <sub>F</sub>	2.5	2.5	4.5	4.0	4.0	4.0	4.0	4.0	V
Reverse current V <sub>R</sub> =5V	I <sub>R</sub>	10	10	10	10	50	50	50	50	μA
Peak Emission Wavelength I <sub>F</sub> =20mA, 10mA, 2mA	λ <sub>P</sub>	590	590	430	468	460	460	461	465	nm
Dominant Wavelength I <sub>F</sub> =20mA, 10mA, 2mA	λ <sub>D</sub>	590	590	466	465	465	465	465	470	nm
Spectral line half-width I <sub>F</sub> =20mA, 10mA, 2mA	Δλ <sub>1/2</sub>	20	20	60	21	25	25	25	22	nm
Capacitance V <sub>F</sub> =0V, f=1MHZ	C	45	45	100	100	100	100	100	100	pF

TECHNICAL DATA 5V/14V WITH INTERNAL RESISTANCE

Absolute maximum ratings (T <sub>A</sub> =25°C)		I Hi.Eff.Red  (GaAsP/GaP)	SR Super Bright Red  (GaAlAs)	G Green  (GaP)	Y Yellow  (GaAsP/GaP)	Unit
Reverse voltage	V <sub>R</sub>	5	5	5	5	V
Forward voltage (Max.) for 5V	V <sub>F</sub>	6	6	6	6	V
Forward voltage (Max.) for 14V	V <sub>F</sub>	16	16	16	16	V
Power dissipation for 5V	P <sub>D</sub>	85	85	85	85	mW
Power dissipation for 14V	P <sub>D</sub>	160	160	160	160	mW
<b>LED LAMPS:</b>						
Operating temperature	T <sub>A</sub>	-40~+70	-40~+70	-40~+70	-40~+70	°C
Storage temperature	T <sub>STG</sub>	-40~+85	-40~+85	-40~+85	-40~+85	°C
<b>LED DISPLAYS:</b>						
Operating temperature	T <sub>A</sub>	-40~+70	-40~+70	-40~+70	-40~+70	°C
Storage temperature	T <sub>STG</sub>	-40~+85	-40~+85	-40~+85	-40~+85	°C

Operating Characteristics		I Hi.Eff.Red  (GaAsP/GaP)	SR Super Bright Red  (GaAlAs)	G Green  (GaP)	Y Yellow  (GaAsP/GaP)	Unit
Forward current (typ.) V <sub>F</sub> =5V	I <sub>F</sub>	13	13	11.5	13	mA
Forward current (typ.) V <sub>F</sub> =14V	I <sub>F</sub>	10.5	10.5	10.5	10.5	mA
Forward current (max.) V <sub>F</sub> =5V	I <sub>F</sub>	17.5	17.5	17.5	17.5	mA
Forward current (max.) V <sub>F</sub> =14V	I <sub>F</sub>	13.5	13.5	13.5	13.5	mA
Reverse current V <sub>R</sub> =5V	I <sub>R</sub>	10	10	10	10	uA
Peak Emission Wavelength V <sub>F</sub> =5V,14V	λ <sub>p</sub>	627	655	565	590	nm
Dominant Wavelength V <sub>F</sub> =5V,14V	λ <sub>D</sub>	617	640	568	588	nm
Spectral line half-width V <sub>F</sub> =5V,14V	Δλ <sub>1/2</sub>	45	20	30	35	nm

## TECHNICAL DATA FOR BLINKING LED LAMPS

Absolute maximum ratings ( $T_A=25^\circ\text{C}$ )		I Hi.Eff.Red  (GaAsP/GaP)	H Bright Red  (GaP)	SR Super Bright Red  (GaAlAs)	Unit
Reverse voltage	$V_R$	0.5	0.5	0.5	V
Forward voltage (max.)	$V_F$	14	14	14	V
Total Power dissipation	$P_D$	310	310	310	mW
Operating temperature	$T_A$	-40~+70	-40~+70	-40~+70	$^\circ\text{C}$
Storage temperature	$T_{STG}$	-40~+85	-40~+85	-40~+85	$^\circ\text{C}$

Operating Characteristics		I Hi.Eff.Red  (GaAsP/GaP)	H Bright Red  (GaP)	SR Super Bright Red  (GaAlAs)	Unit
Forward current (min.) $V_F=3.5\text{V}$	$I_F$	8	8	8	mA
Forward current (typ.) $V_F=5\text{V}$	$I_F$	22	22	22	mA
Supply current $V_F=3.5\text{V} \sim 14\text{V}$	$I_{SON}$	8 ~ 44	8 ~ 44	8 ~ 44	mA
Blink frequency $V_F=3.5\text{V} \sim 14\text{V}$	$f$	3 ~ 1.5	3 ~ 1.5	3 ~ 1.5	Hz
Peak Emission Wavelength	$\lambda_p$	627	700	655	nm
Dominant Wavelength	$\lambda_D$	617	635	640	nm
Spectral line half-width	$\Delta\lambda_{1/2}$	45	45	20	nm

TECHNICAL DATA FOR INFRARED

Absolute maximum ratings (T <sub>A</sub> =25°C)		F3 (GaAs)	SF4 (GaAlAs)	SF6 (GaAlAs)	SF7 (GaAlAs)	Unit
Reverse voltage	V <sub>R</sub>	5	5	5	5	V
Forward current	I <sub>F</sub>	50	50	50	50	mA
Forward current (Peak) 1/100 Duty Cycle, 10µs Pulse Width	i <sub>FS</sub>	1.2	1.2	1	1	A
Power dissipation	P <sub>D</sub>	80	80	80	80	mW
<b>LED LAMPS:</b>						
Operating temperature	T <sub>A</sub>	- 40~+85	- 40~+85	- 40~+85	- 40~+85	°C
Storage temperature	T <sub>STG</sub>	- 40~+85	- 40~+85	- 40~+85	- 40~+85	°C
<b>LED DISPLAYS:</b>						
Operating temperature	T <sub>A</sub>	- 40~+85	- 40~+85	- 40~+85	- 40~+85	°C
Storage temperature	T <sub>STG</sub>	- 40~+85	- 40~+85	- 40~+85	- 40~+85	°C

Operating Characteristics		F3 (GaAs)	SF4 (GaAlAs)	SF6 (GaAlAs)	SF7 (GaAlAs)	Unit
Forward voltage (typ.) I <sub>F</sub> =20mA	V <sub>F</sub>	1.2	1.3	1.35	1.4	V
Forward voltage (max.) I <sub>F</sub> =20mA	V <sub>F</sub>	1.6	1.6	1.6	1.6	V
Reverse current V <sub>R</sub> =5V	I <sub>R</sub>	10	10	10	10	µA
Peak Emission Wavelength I <sub>F</sub> =20mA	λ <sub>p</sub>	940	880	860	850	nm
Spectral line half-width I <sub>F</sub> =20mA	Δλ <sub>1/2</sub>	50	50	50	50	nm
Capacitance V <sub>F</sub> =0V, f=1MHZ	C	90	90	30	30	pF

## TECHNICAL DATA

### High Efficiency Red, Orange

### E, I : GaAsP/GaP

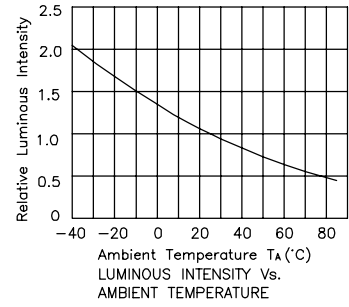
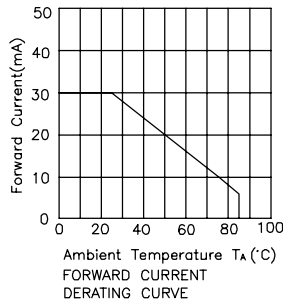
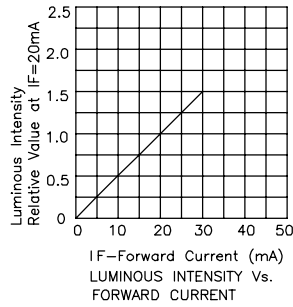
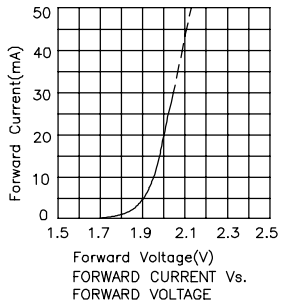

### Bright Red

### H : GaP

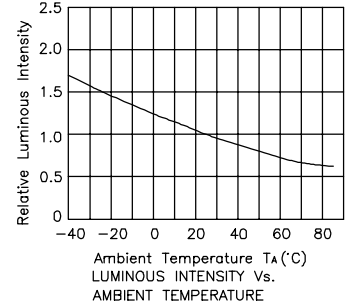
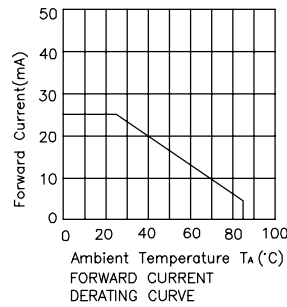
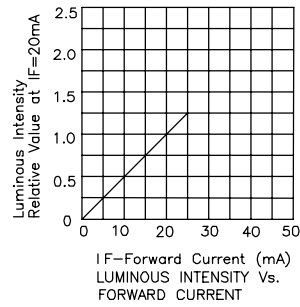
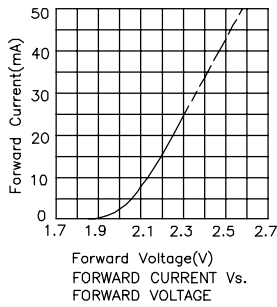

### Super Bright Red

### SR : GaAlAs

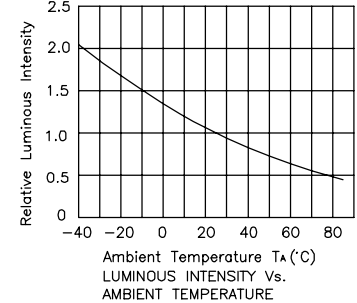
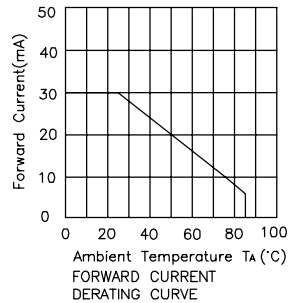
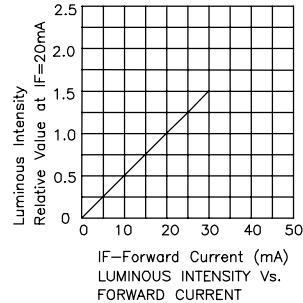
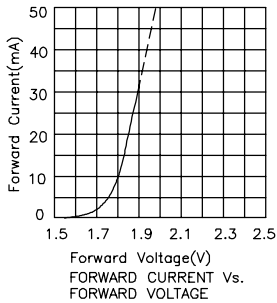

### Super Bright Red

### SR-J4 : AlGaInP

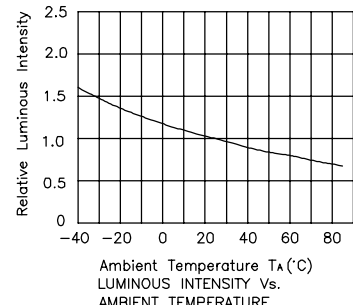
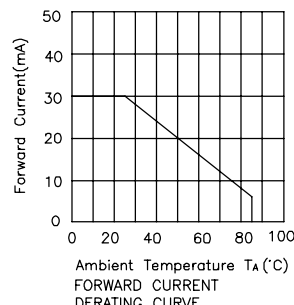
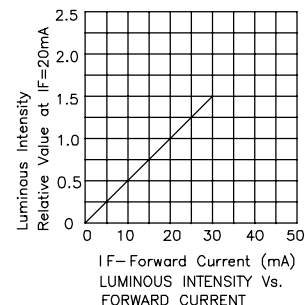
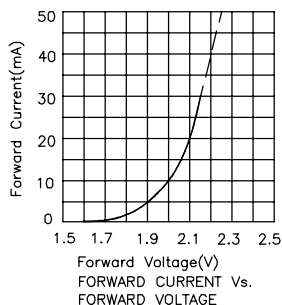



TECHNICAL DATA

Hyper Red

SURK : AlGaInP

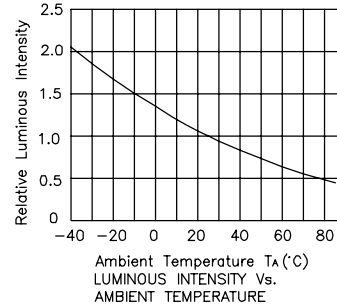
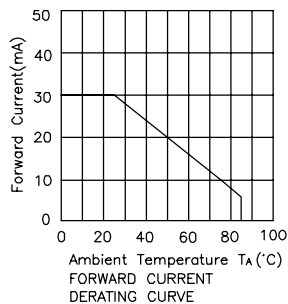
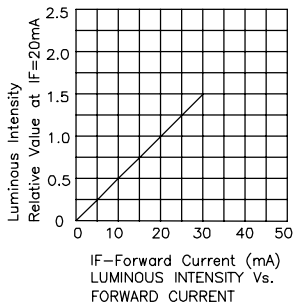
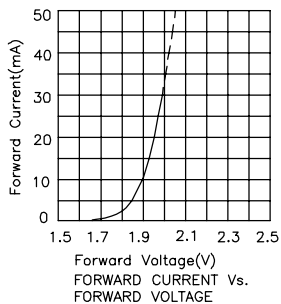

Hyper Red

SURK-T : AlGaInP

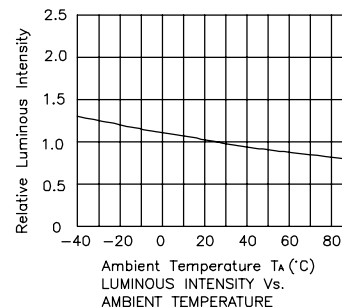
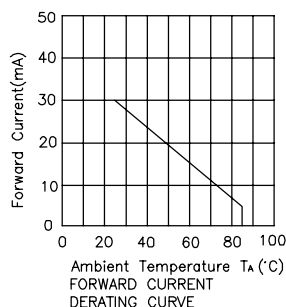
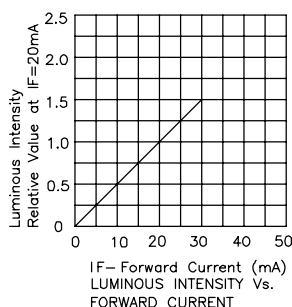
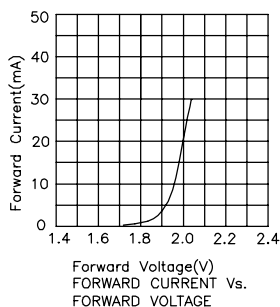

Hyper Red

SUR-E : AlGaInP

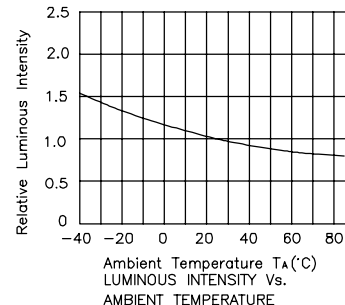
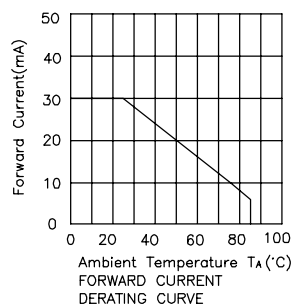
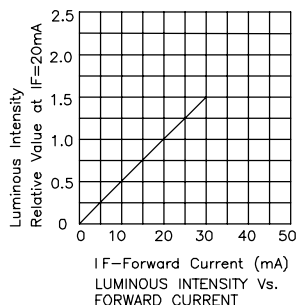
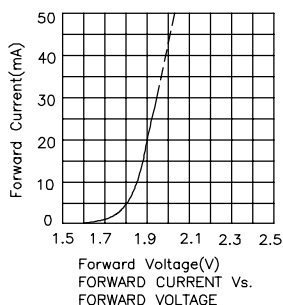

Hyper Red

SUR-G : AlGaInP

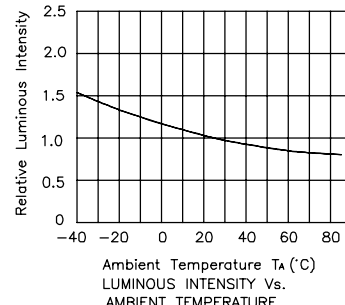
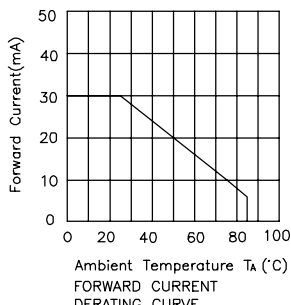
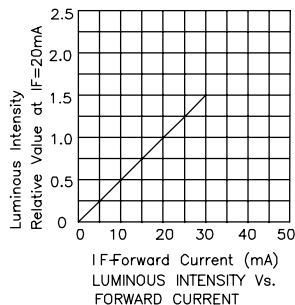
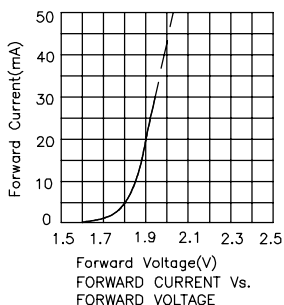

TECHNICAL DATA

Hyper Red

SE-J3-K, SE-J3 : AlGaInP

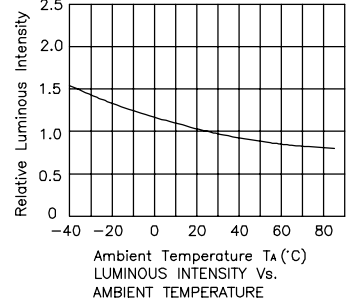
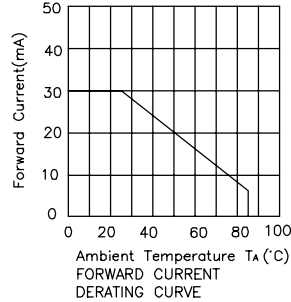
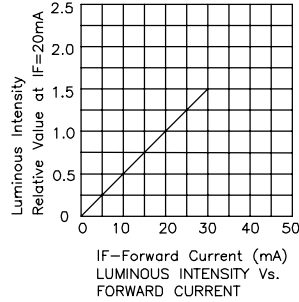
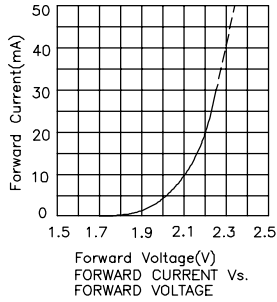

Hyper Red

SE-E : AlGaInP

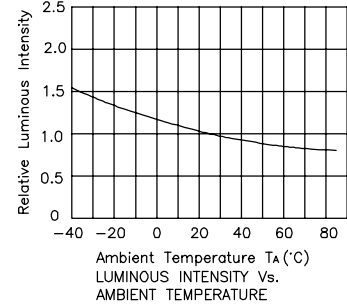
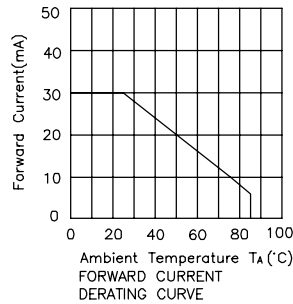
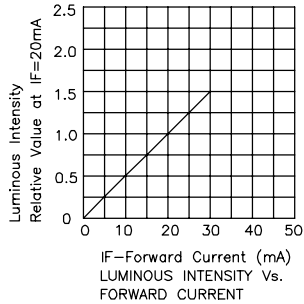
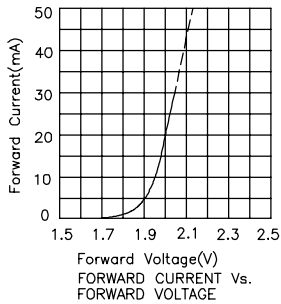

Hyper Red

SE-H : AlGaInP

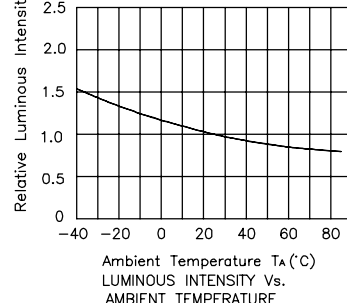
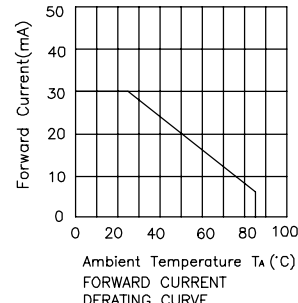
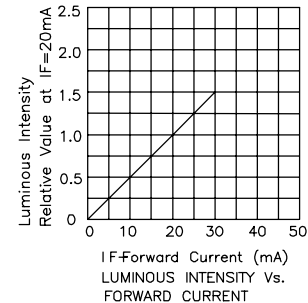
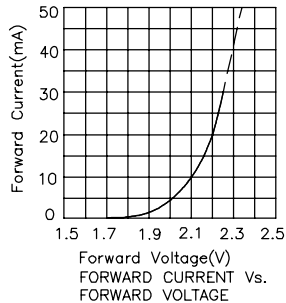

Super Bright Orange

SE-J4-K, SE-J4 : AlGaInP

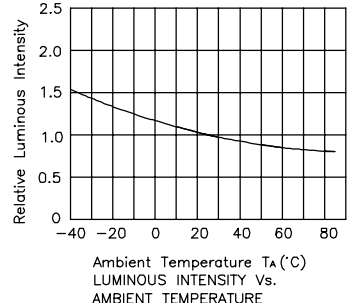
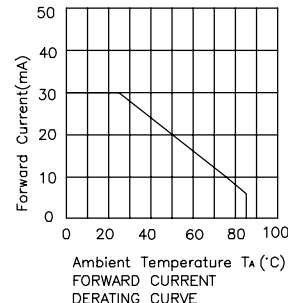
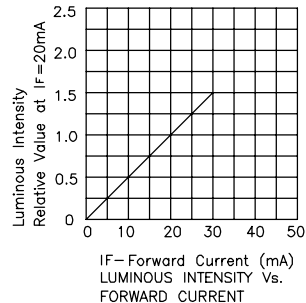
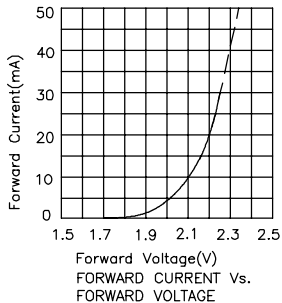

TECHNICAL DATA

Pure Orange

N : GaAsP/GaP

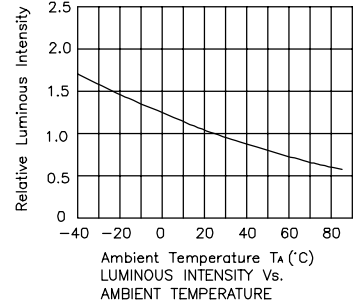
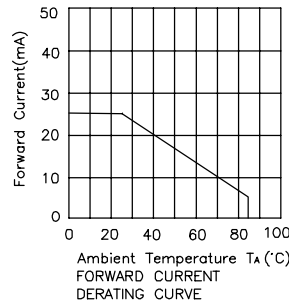
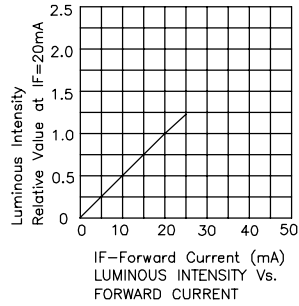
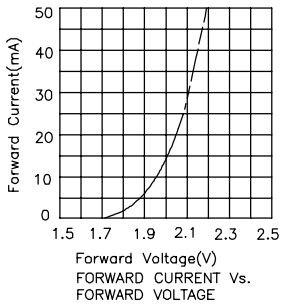

Super Bright Orange

SEK : AlGaInP

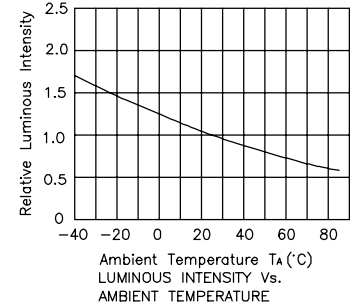
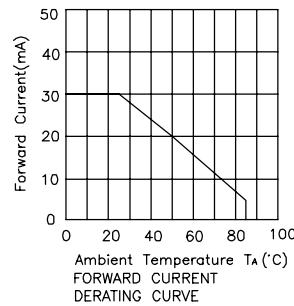
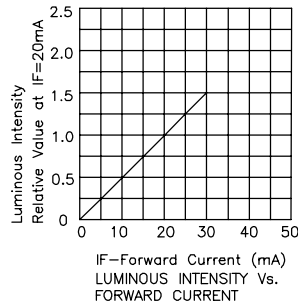
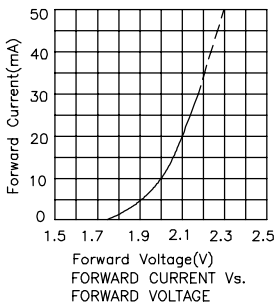

Super Bright Orange

SEK-T : AlGaInP

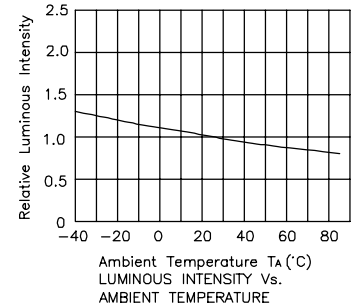
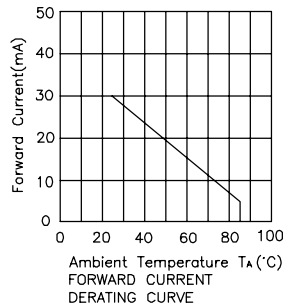
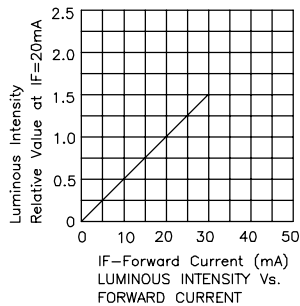
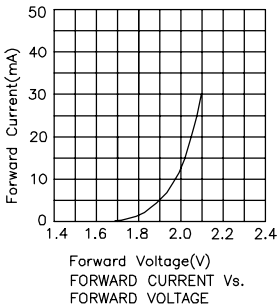

Green/Super Bright Green

G, SG : GaP

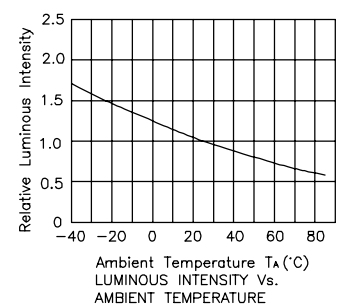
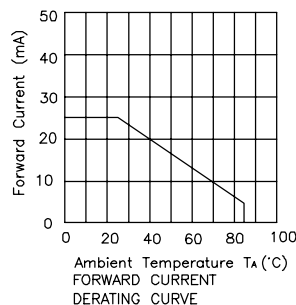
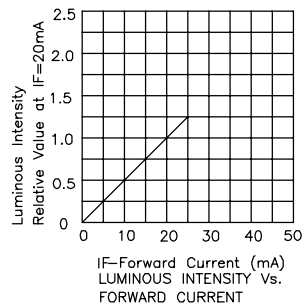
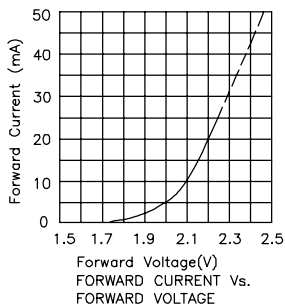

## TECHNICAL DATA

### Green

### CGK : AlGaInP

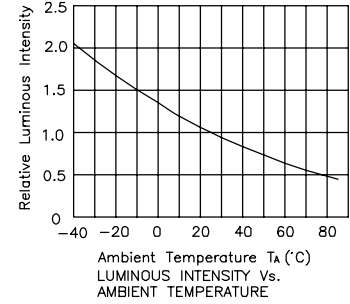
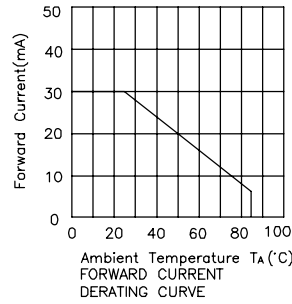
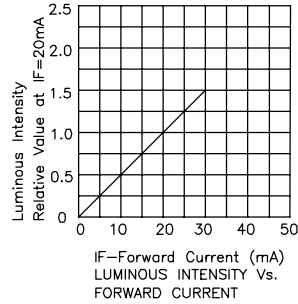
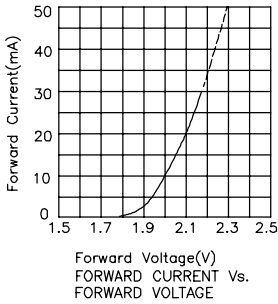

### Green

### CGK-T : AlGaInP

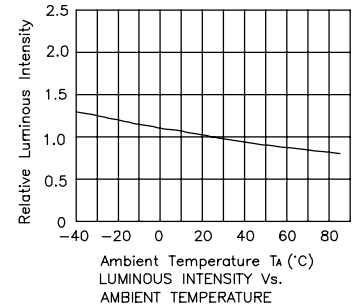
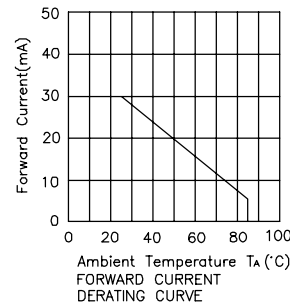
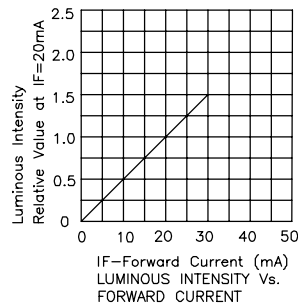
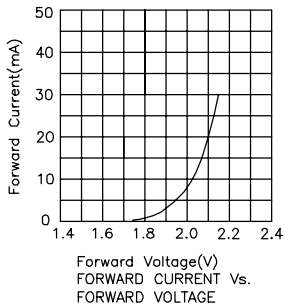

### Green

### ZG-K : InGaN

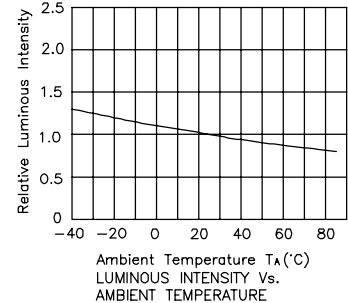
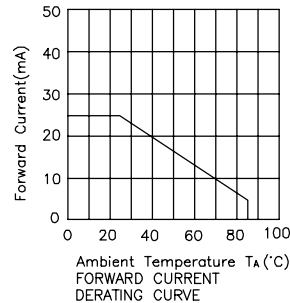
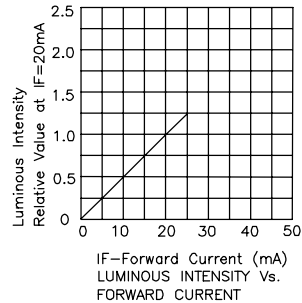
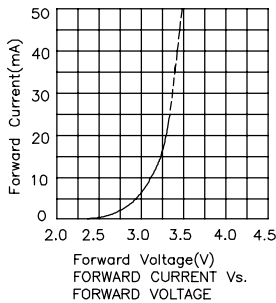

### Green

### ZG : InGaN

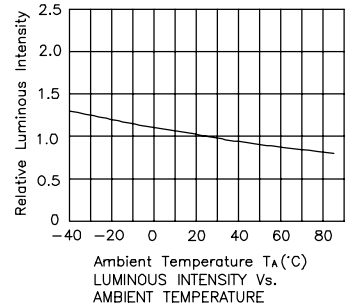
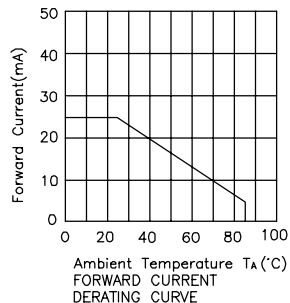
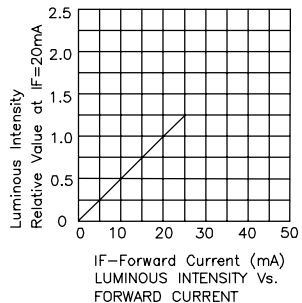
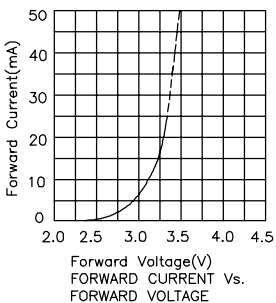

TECHNICAL DATA

Green

ZG-E, ZG-G : InGaN

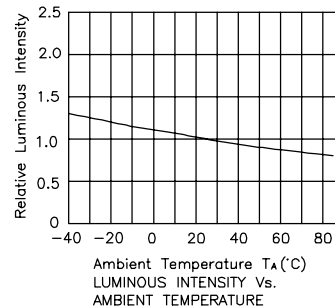
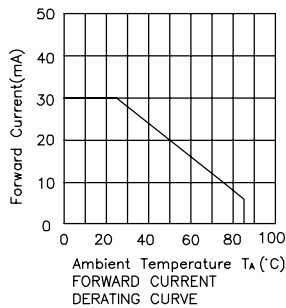
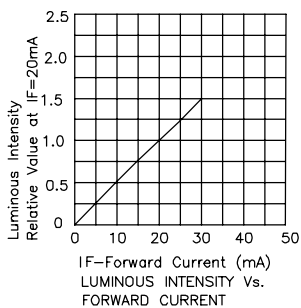
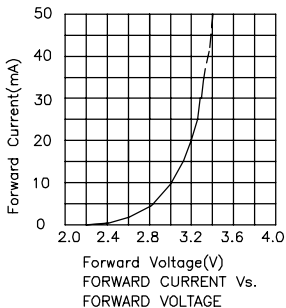

Yellow

Y : GaAsP/GaP

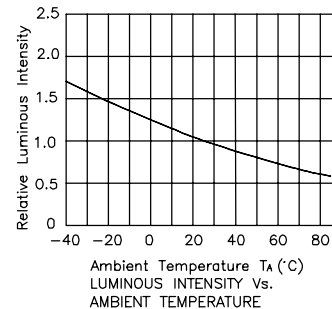
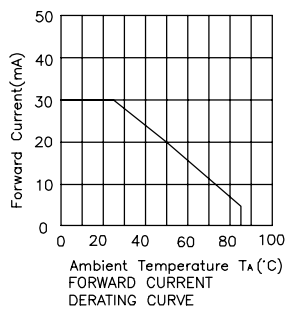
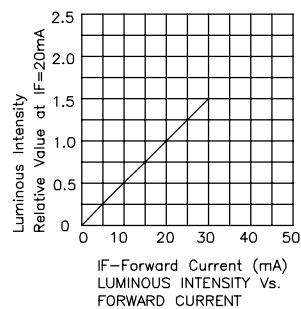
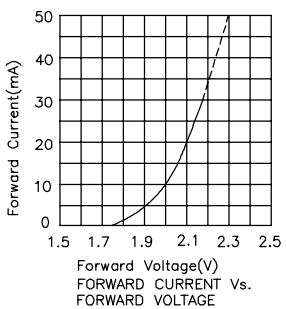

Super Bright Yellow

SYK, SY, SY-J3-K, SY-J3 : AlGaInP

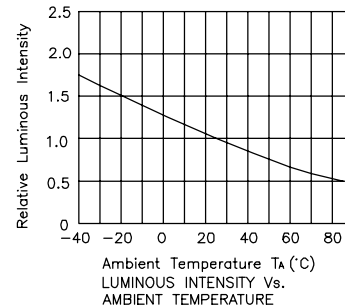
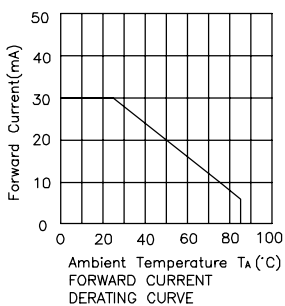
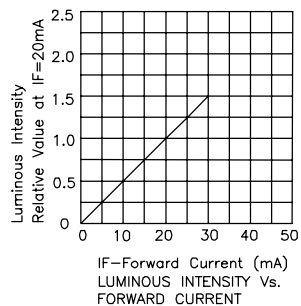
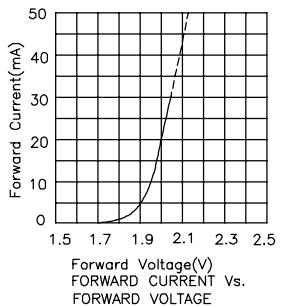

Super Bright Yellow

SYK-T : AlGaInP

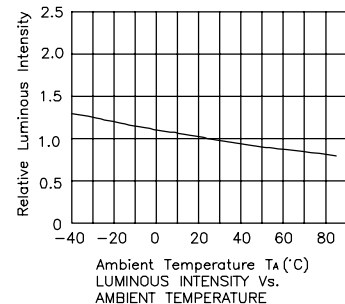
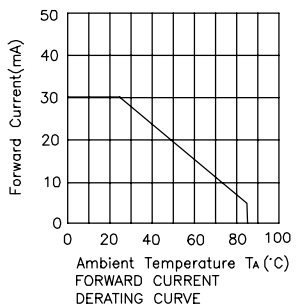
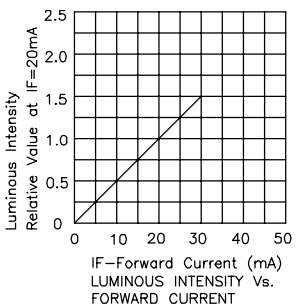
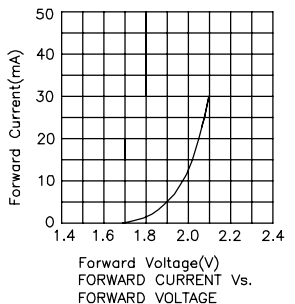

## TECHNICAL DATA

Blue

MB : GaN

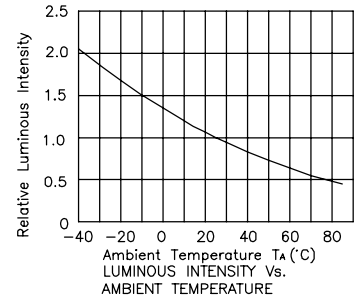
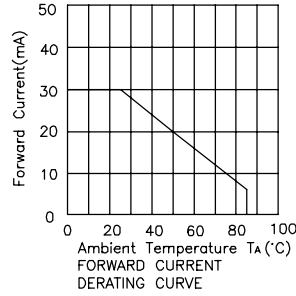
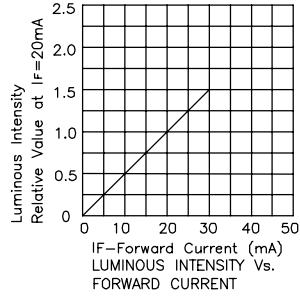
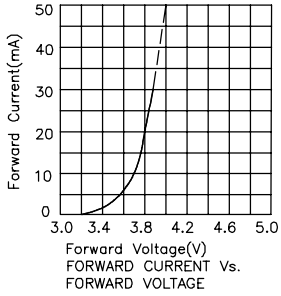

Blue

PB-A : InGaN

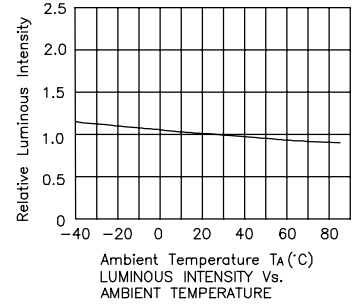
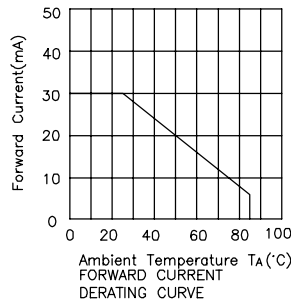
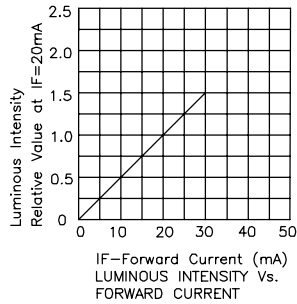
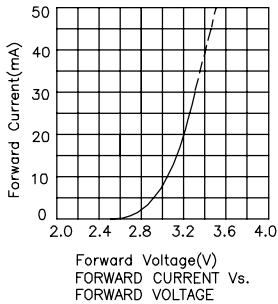

Blue

QB-D, QB-F, QB-G : InGaN

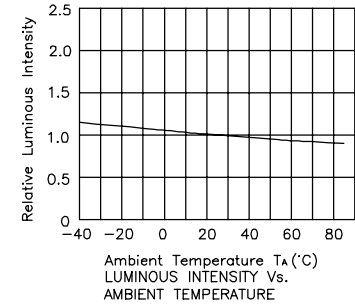
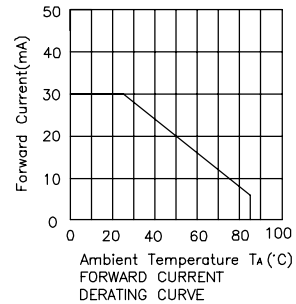
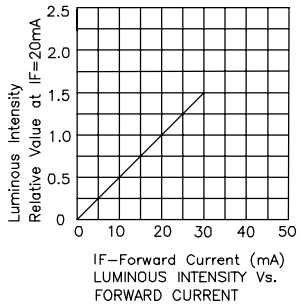
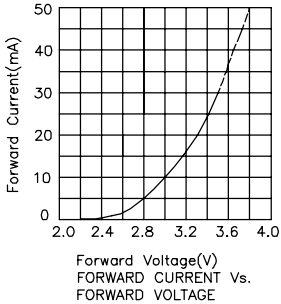

Blue

VB-D : InGaN

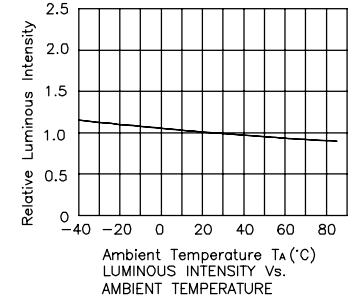
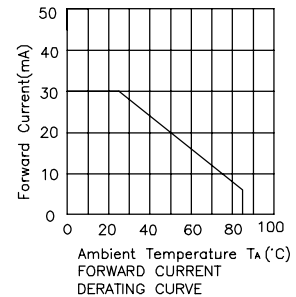
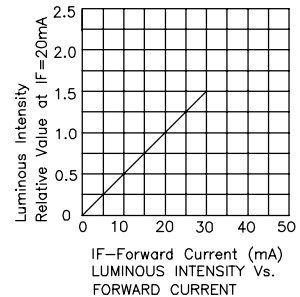
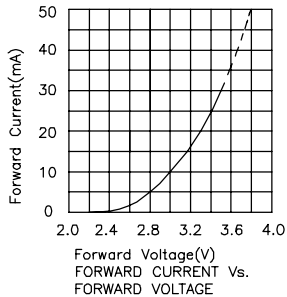

**BIN CODE SYSTEMS**

SELECTION CODE FOR STANDARD AND LOW CURRENT LEDs (T <sub>A</sub> =25°C Tolerance +/-15% IF<15mA)					
Group	Light intensity in mcd		Group	Light intensity in mcd	
	Min.	Max.		Min.	Max.
F	0.1	0.2	W	120	180
G	0.2	0.35	X	180	250
H	0.35	0.5	Y	250	320
I	0.5	0.8	Z	320	450
K	0.8	1.2	ZA	450	550
L	1.2	2	ZB	550	700
M	2	4	ZC	700	1000
N	4	6	ZD	1000	1600
P	6	10	ZE	1600	2200
Q	10	15	ZF	2200	2800
R	15	20	ZG	2800	3400
S	20	30	ZH	3400	4300
T	30	50	ZM	4300	5200
U	50	80	ZN	5200	6300
V	80	120	ZP	6300	7400

SELECTION CODE FOR NPN PHOTOTRANSISTORS (T <sub>A</sub> =25°C Tolerance +/-15%)					
Group	Photocurrent(mA)		Group	Photocurrent(mA)	
	Min.	Max.		Min.	Max.
F	0.1	0.2	L	1.2	2
G	0.2	0.35	M	2	4
H	0.35	0.5	N	4	6
I	0.5	0.8	P	6	10
K	0.8	1.2	-	-	-

SELECTION CODE FOR INFRARED EMITTING DIODES (T <sub>A</sub> =25°C Tolerance +/-15%)					
Group	Radiant intensity in mW/sr		Group	Radiant intensity in mW/sr	
	Min.	Max.		Min.	Max.
AK	0.8	1.2	D	8	12
AL	1.2	2	E	12	20
A	2	3	F	20	40
B	3	5	G	40	55
C	5	8	H	55	80

SELECTION CODE FOR SUPER BRIGHT LEDs (T <sub>A</sub> =25°C Tolerance +/-15% IF≥15mA)					
Group	Light intensity in mcd		Group	Light intensity in mcd	
	Min.	Max.		Min.	Max.
A	2	3	ZA	3100	3600
B	3	5	ZB	3600	4200
C	5	8	ZC	4200	5000
D	8	12	ZD	5000	6000
E	12	20	ZE	6000	7000
F	20	40	ZF	7000	8000
G	40	55	ZG	8000	9000
H	55	80	ZH	9000	11000
M	80	120	ZM	11000	14000
N	120	200	ZN	14000	18000
P	200	300	ZP	18000	22000
Q	300	400	ZQ	22000	27000
R	400	500	ZR	27000	35000
S	500	700	ZS	35000	43000
T	700	1000	ZT	43000	55000
U	1000	1300	ZU	55000	75000
V	1300	1600	ZV	75000	130000
W	1600	1900	ZW	130000	200000
X	1900	2300	ZX	200000	320000
Y	2300	2700	ZY	320000	490000
Z	2700	3100	ZZ	490000	800000

SELECTION CODE FOR DISPLAYS (T <sub>A</sub> =25°C Tolerance +/-15%)					
Group	Light intensity in ucd		Group	Light intensity in ucd	
	Min.	Max.		Min.	Max.
C	70	140	P	14000	21000
D	140	240	Q	21000	31000
E	240	360	R	31000	52000
F	360	560	S	52000	88000
G	560	900	T	88000	150000
H	900	1400	U	150000	255000
I	1400	2200	V	255000	433000
K	2200	3600	W	433000	736000
L	3600	5600	X	736000	1251000
M	5600	9000	Y	1251000	2126000
N	9000	14000	Z	2126000	3614000

## BIN CODE SYSTEMS

SELECTION CODE FOR LUMINOUS FLUX (T <sub>A</sub> =25°C; Tolerance: +/-15%)					
Group	Luminous Flux in lm		Group	Luminous Flux in lm	
	Min.	Max.		Min.	Max.
A1	0.5	0.6	B10	50	60
A2	0.6	0.7	B11	60	70
A3	0.7	0.8	B12	70	80
A4	0.8	1	B13	80	90
A5	1	1.2	B14	90	100
A6	1.2	1.4	C1	100	120
A7	1.4	1.7	C2	120	140
A8	1.7	2	C3	140	160
A9	2	2.4	C4	160	180
A10	2.4	2.9	C5	180	210
A11	2.9	3.5	C6	210	240
A12	3.5	4.2	C7	240	280
A13	4.2	5	C8	280	320
A14	5	6	C9	320	370
A15	6	7.2	C10	370	430
A16	7.2	8.6	C11	430	490
A17	8.6	10	C12	490	560
B1	10	12	C13	560	640
B2	12	14	C14	640	740
B3	14	17	C15	740	850
B4	17	20	C16	850	1000
B5	20	24	D1	1000	1200
B6	24	29	D2	1200	1400
B7	29	35	D3	1400	1600
B8	35	42	D4	1600	1800
B9	42	50	D5	1800	2100

COLOR CODE FOR GREEN LEDS + DISPLAYS (T <sub>A</sub> =25°C; Tolerance: +/-1nm)				
Group	Dom. Wavelength (nm)			
	Min.	Max.	Min.	Max.
0	556	559	-	-
1	559	561	515	520
2	561	563	520	525
3	563	565	525	530
4	565	567	530	535
5	567	569	535	540
6	569	571	-	-
7	571	573	-	-
8	573	575	-	-

COLOR CODE FOR BLUE LEDS + DISPLAYS (T <sub>A</sub> =25°C; Tolerance: +/-1nm)					
Group	Dom. Wavelength (nm)		Group	Dom. Wavelength (nm)	
	Min.	Max.		Min.	Max.
1	445	450	3A	471	473
2	450	455	3B	473	475
3	455	460	4A	475	477
1A	460	463	4B	477	479
1B	463	466	5A	479	481
2A	466	469	5B	481	483
2B	469	471	5C	483	486

COLOR CODE FOR YELLOW LEDS + DISPLAYS (T <sub>A</sub> =25°C; Tolerance: +/-1nm)					
Group	Dom. Wavelength (nm)		Group	Dom. Wavelength (nm)	
	Min.	Max.		Min.	Max.
1	581	584	5	590	592
2	584	586	6	592	594
3	586	588	7	594	597
4	588	590	8	597	600

SOLDERING INSTRUCTIONS						
Types	Dip soldering / * wave soldering			Iron soldering (with 1.5mm iron tip)		
	Temperature of the soldering bath	Maximum soldering time	Distance from solder joint to package	Temperature of soldering iron	Maximum soldering time	Distance from solder joint to package
LEDS	<=260°C	3s	>=2mm	<=350°C	3s	>2mm
	<=260°C	5s	>=5mm	<=350°C	5s	>5mm
SMDS	-	-	-	<=350°C	3s (one time only)	-
DISPLAYS	*<=260°C	*3s	*>2mm	<=350°C	3s	>2mm
PHOTOCOUPLER	<=260°C	3s	>2mm	<=310°C	3s	-
	-	-	-	<=260°C	10s	-



APPLICATION NOTES

General Notes

1. We recommend manual soldering operations only for repair and rework purposes. The soldering iron should not exceed 30W in power. The maximum soldering temperature is 300°C for Pb-Sn solder and 350°C for lead-free solder for normal lamps and displays. For blue (typ.:465nm), green (typ.:525nm), and all white LEDs, the maximum soldering iron temperature is 280°C. Do not place the soldering iron on the component for more than 3 seconds.

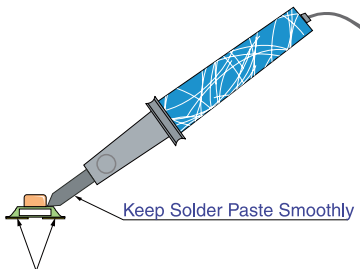

2. The tip of the soldering iron should never touch the epoxy lens.
3. Do not apply stress to the leads when the component is heated above 85°C, otherwise internal wire bonds may be damaged.
4. Through-Hole LEDs are incompatible with reflow soldering.
5. If the LED will undergo multiple soldering passes or face other processes where the part may be subjected to intense heat, please check with Kingbright for compatibility.
6. SMD products must be mounted according to specified soldering pad patterns. Refer to the product datasheet for details. Solder paste must be evenly applied to each soldering pad to insure proper bonding and positioning of the component.

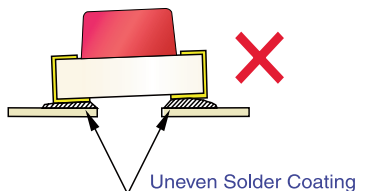

7. After soldering, allow at least three minutes for the component to cool down to room temperature before further operations.
8. Recommended PCB pin hole diameters for display products are listed below :

Round pin type : 2 x pin diameters

Square pin type :

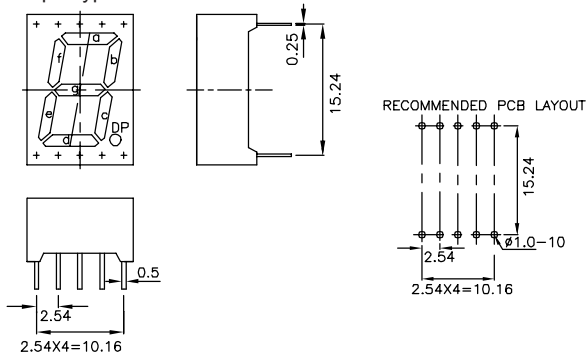

9. Data subject to change without notice. For additional detail of application notes, product information, and disclaimers, please visit our website at [http://www.kingbright.com/application\\_notes](http://www.kingbright.com/application_notes).

Recommended Wave Soldering Profiles For Kingbright Through-Hole Products

1. Lead-Free Wave Soldering Profile

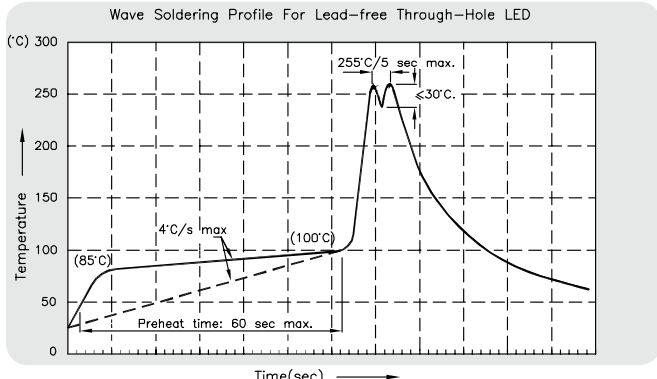

Notes:

- 1.Recommend pre-heat temperature of 105°C or less (as measured with a thermocouple attached to the LED pins) prior to immersion in the solder wave with a maximum solder bath temperature of 260°C
- 2.Peak wave soldering temperature between 245°C ~ 255°C for 3 sec (5 sec max).
- 3.Do not apply stress to the epoxy resin while the temperature is above 85°C.
- 4.Fixtures should not incur stress on the component when mounting and during soldering process.
- 5.SAC 305 solder alloy is recommended.
- 6.No more than one wave soldering pass.
- 7.During wave soldering, the PCB top-surface temperature should be kept below 105°C.

2. Wave Soldering Profile With Pb-Sn Solder

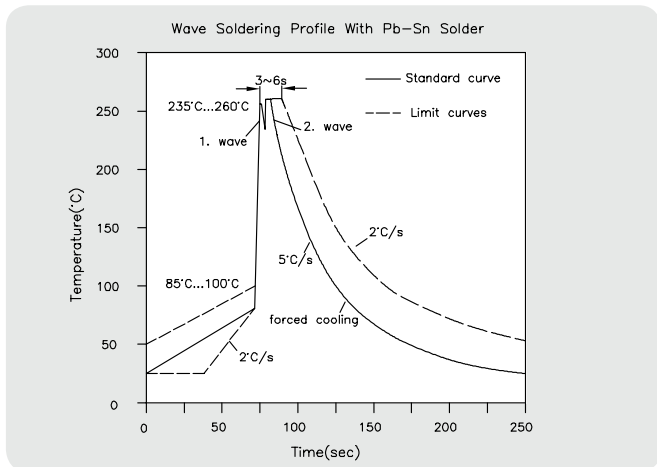

Recommended Reflow Soldering Profiles For Kingbright SMD Products

1. Lead-Free Reflow Soldering Profile

No more than two soldering passes with the recommended profile.

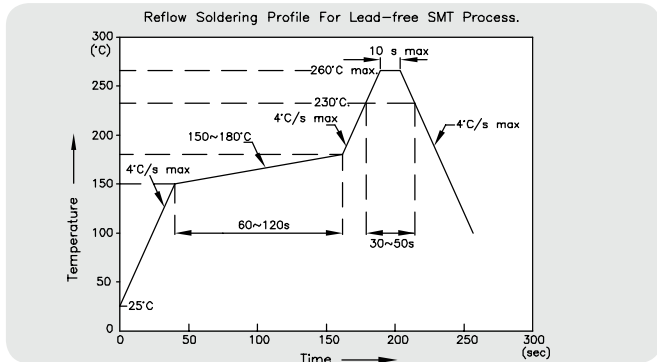

NOTES:

- 1.We recommend the reflow temperature 245°C(+/-5°C).The maximum soldering temperature should be limited to 260°C.
- 2.Don't cause stress to the epoxy resin while it is exposed to high temperature.
- 3.Number of reflow process shall be 2 times or less.

### 2. Reflow Soldering Profiles With Pb-Sn Solder

No more than two soldering passes with the recommended profile.

Recommended Reflow Profile

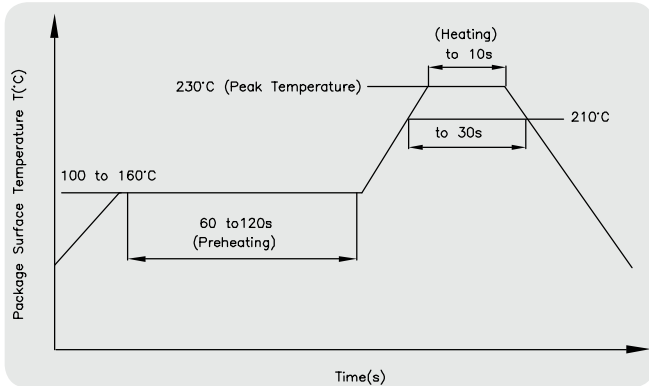

### Static Electricity and Voltage Spikes in InGaN/GaN Products

InGaN/GaN products are sensitive to electrostatic discharge (ESD) and other transient voltage spikes. ESD and voltage spikes can affect the component's reliability, increase reverse current, and decrease forward voltage. This may result in reduced light intensity or cause component failure.

Kingbright InGaN/GaN products are stored in anti-static packaging for protection during transport and storage. Please note the anti-static measures below when handling Kingbright InGaN/GaN products.

### Design Precautions

Products using InGaN/GaN components must incorporate protection circuitry to prevent ESD and voltage spikes from reaching the vulnerable component.

### ESD Protection During Production

Static discharge can result when static-sensitive products come in contact with the operator or other conductors. The following procedures may decrease the possibility of ESD damage:

1. Minimize friction between the product and surroundings to avoid static buildup.
2. All manufacturing and testing equipment should be grounded.
3. All personnel in an ESD protected area should wear antistatic garments and wrist straps.
4. Set up ESD protection areas using grounded metal plating for component handling.
5. All workstations that handle IC and ESD-sensitive components must maintain an electrostatic potential of 150V or less.
6. Relative humidity levels maintained between 40% and 60% in production area are recommended to avoid the build-up of static electricity – Ref JEDEC/JESD625-A and JEDEC/J-STD-033.
7. Use anti-static packaging for transport and storage.
8. All anti-static equipment and procedures should be periodically inspected and evaluated for proper functionality.

### LED Mounting Method

1. The lead pitch of the LED must match the pitch of the mounting holes on the PCB during component placement. Lead-forming may be required to insure the lead pitch matches the hole pitch. Refer to (Fig.1) for proper lead forming procedures.

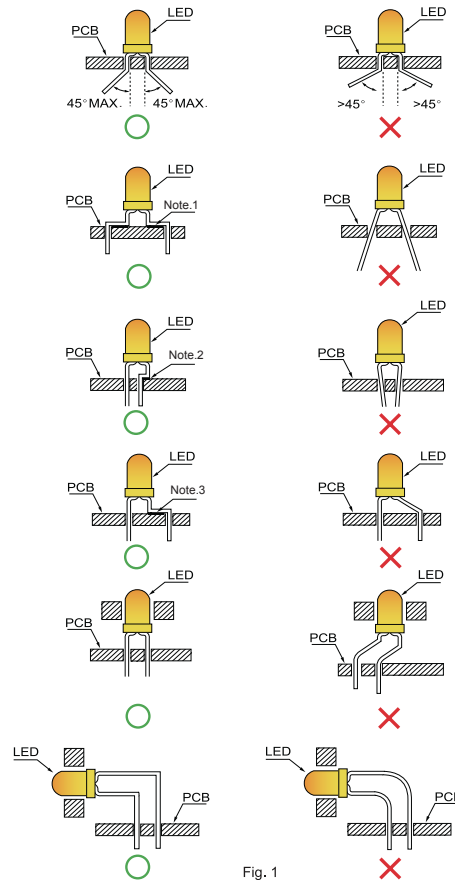

“○” Correct mounting method “X” Incorrect mounting method

2. When soldering wires to the LED, each wire joint should be separately insulated with heat-shrink tube to prevent short-circuit contact. Do not bundle both wires in one heat shrink tube to avoid pinching the LED leads. Pinching stress on the LED leads may damage the internal structures and cause failure. (Fig.2)

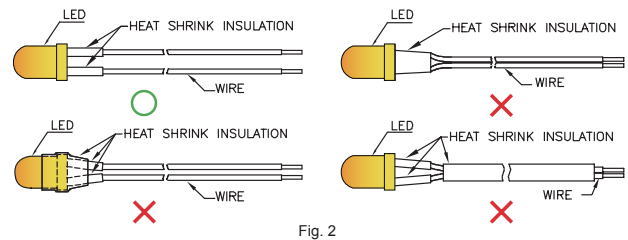

Fig. 2

3. Use stand-offs (Fig.3) or spacers (Fig.4) to securely position the LED above the PCB.

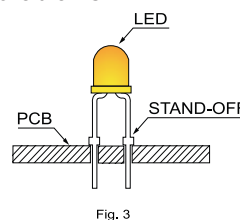

Fig. 3

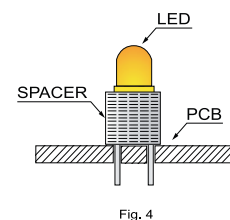

Fig. 4

4. Do not route PCB trace in the contact area between the leadframe and the PCB to prevent short-circuits.

**Lead Forming Procedures**

1. Maintain a minimum of 3mm clearance between the base of the LED lens and the first lead bend. (Fig. 5 and 6)

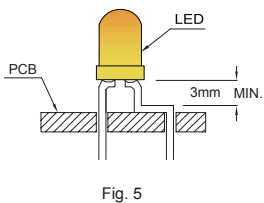

Fig. 5

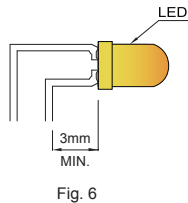

Fig. 6

2. Lead forming or bending must be performed before soldering, never during or after soldering.

3. Do not stress the LED lens during lead-forming in order to prevent fractures in the epoxy lens and damage the internal structures.

4. During soldering, component covers and holders should leave clearance to avoid placing damaging stress on the LED during soldering. (Fig. 7)

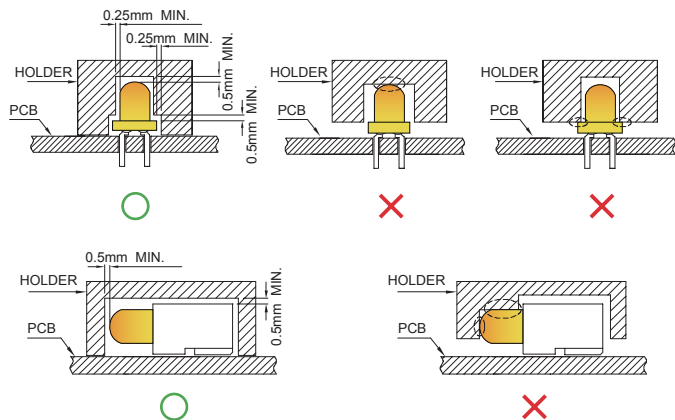

Fig. 7

5. During lead forming, use tools or jigs to hold the leads securely so that the bending force will not be transmitted to the LED lens and its internal structures. Do not perform lead forming once the component has been mounted onto the PCB. (Fig. 8)

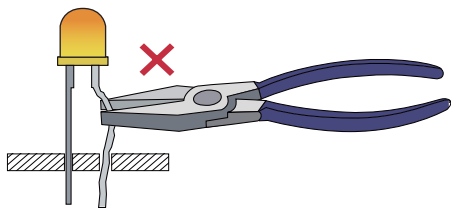

Fig. 8

6. Do not bend the leads more than twice. (Fig. 9)

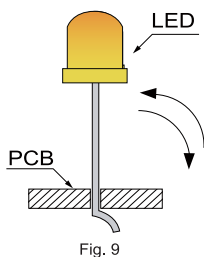

Fig. 9

7. After soldering or other high-temperature assembly, allow the LED to cool down to 50°C before applying outside force (Fig. 10). In general, avoid placing excess force on the LED to avoid damage. For any questions please consult with Kingbright representative for proper handling procedures.

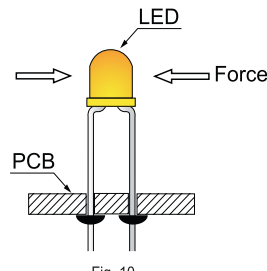

Fig. 10

**Cleaning**

1. Do not use harsh organic solvents for cleaning because they may cloud or damage the LED lens.
2. Isopropyl alcohol or deionized water are recommended solvents for cleaning.
3. Special attention should be taken if other chemicals are used for cleaning because other solvents may damage the epoxy in the lens or housing.
4. The cleaning process should take place at room temperature and the devices should not be washed for more than one minute.
5. When water is used for cleaning, immediately use forced-air drying to remove excess moisture from the LED.
6. Do not use acidic solvents or unknown chemicals to clean the component. Before using any cleaning solvent, check to insure the chemical composition will not corrode or damage epoxy resin, organosilicates, silicone resin, and silver plating, in order to prevent accidental damage or degraded function.
7. Typically we suggest ethanol for cleaning SMD LEDs. Lightly wipe away any surface contaminants and avoid excessive force that might damage the lens surface or internal structures. Allow to dry under room temperature conditions before further usage. Do not soak the SMD LED in ethanol or other solutions.

**Miscellaneous Design Notes**

1. Protective current-limiting resistors may be necessary to operate the LEDs within the specified range.
2. LEDs mounted in parallel should each be placed in series with its own current-limiting resistor.

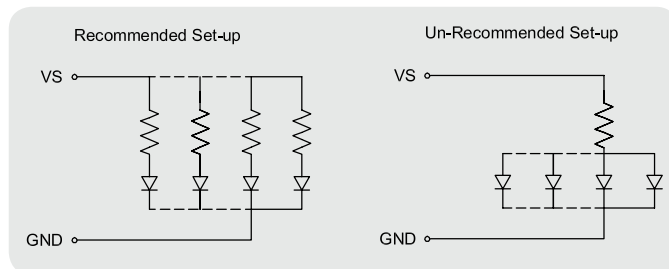

3. The driving circuit should be designed to avoid reverse voltages and transient voltage spikes when the circuit is powered up or shut down.
4. High temperatures can reduce device performance and reliability. Keep LED devices away from heat source for best performance.
5. The safe operation current should be chosen after considering the maximum ambient temperature of the operating environment.

6. During soldering, SMD components should be mounted such that the leads are placed perpendicular to the direction of PCB travel to ensure the solder on each lead melts simultaneously during reflow.

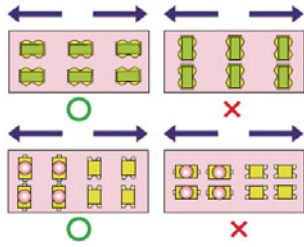

7. Optimal usage of high-power LED devices requires careful design by the end-user to optimize heat dissipation, such as increasing the size of the metal backing around the soldering pad. Refer to the product datasheet for specific design recommendations regarding heat dissipation.

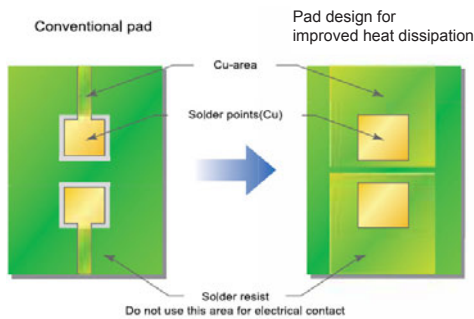

### Restrictions on Product Use

1. Not all devices and product families are available in every country.
2. The light output from UV, blue, white, and other high-power LEDs may cause injury to the human eye when viewed directly.
3. LED devices may contain gallium arsenide (GaAs) material. GaAs is harmful if ingested. GaAs dust and fumes are toxic. Do not break, cut, or pulverize LED devices. Do not dissolve LEDs in chemical solvents.
4. Semiconductor devices can fail or malfunction due to their sensitivity to electrical fluctuation and physical stress. It is the responsibility of the user to observe all safety standards when using Kingbright products, in order to avoid situations in which the malfunction or failure of a Kingbright product could cause injury, property damage, or the loss of human life. In developing designs, please insure that Kingbright products are used within specified operating conditions as set forth in the most recent product specification datasheet.
5. For LEDs with silicone encapsulation such as the AA and AT series, the outer diameter of the pick-up nozzle must be longer than that of the LED's light emitting area. i. e.  $A > C$ , and B shall be shorter than the width of the LED.

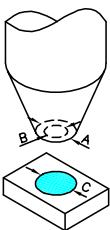

A is the outer diameter pick-up nozzle  
 B is the inner diameter of the nozzle  
 C is the diameter of lens

6. The size of the nozzle should be as large as possible if the tape is not involved.
7. The LEDs should not be exposed to an environment where high level of moisture or corrosive gases are present.
8. Prolonged reverse bias should be avoided, as it could cause metal migration, leading to an increase in leakage current or causing a short circuit.
9. Excess driving current and/or operating temperature higher than recommended conditions may result in severe light degradation or premature failure.
10. It is not recommended to assemble LEDs of different color or intensity bins together, as there may be perceivable color or intensity variation. Each bag contains parts from the same bin code. The bin code is printed on the bag's label as below.

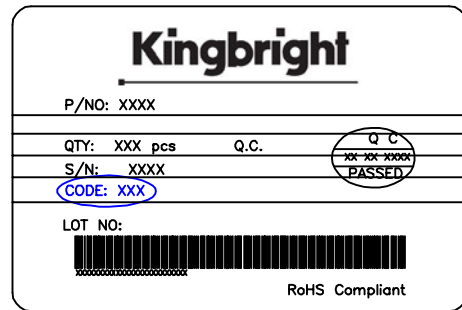

### Storage Control For SMD Products

1. Before a sealed moisture barrier bag (MBB) is opened, contained LEDs shall be kept in an environment with temperature below 40°C and humidity below 90% RH. MBB shall be kept sealed until LEDs contained in the bag are ready to be used. Once MBB is opened, it shall be stored in an environment with temperature range of 5°C~30°C and humidity below 60% RH.
2. Once MBB is opened, all contained LEDs shall complete soldering process within the specified time frame according to the conditions labeled on Kingbright MBB.
3. When the 10% spot of a humidity indicator card (HIC) from MBB indicates wet, the contained LEDs shall be baked according to the baking conditions labeled on Kingbright MBB before mounting.

### For Through-Hole Products

1. Avoid continued exposure to the condensing moisture environment and keep the product away from rapid transitions in ambient temperature.
2. LEDs should be stored with temperature  $\leq 30^\circ\text{C}$  and relative humidity  $< 60\%$ .
3. Product in the original sealed package is recommended to be assembled within 72 hours of opening. Product in opened package for more than a week should be baked for 30 (+10/-0) hours at 85 ~ 100°C.
4. The LED leadframe surface is plated with silver. When the leadframe is stored under high-humidity environments, or exposed to certain chemical elements or gases, the surface may become discolored. Please maintain the cleanliness of the storage environment.
5. If the storage conditions do not meet specification standards, the component pins may become oxidized requiring re-plating and re-sorting before use. Suggest customers consume LEDs as soon as possible, and avoid long-term storage of large inventories.

CIE CHROMATICITY DIAGRAM

White Bin Code

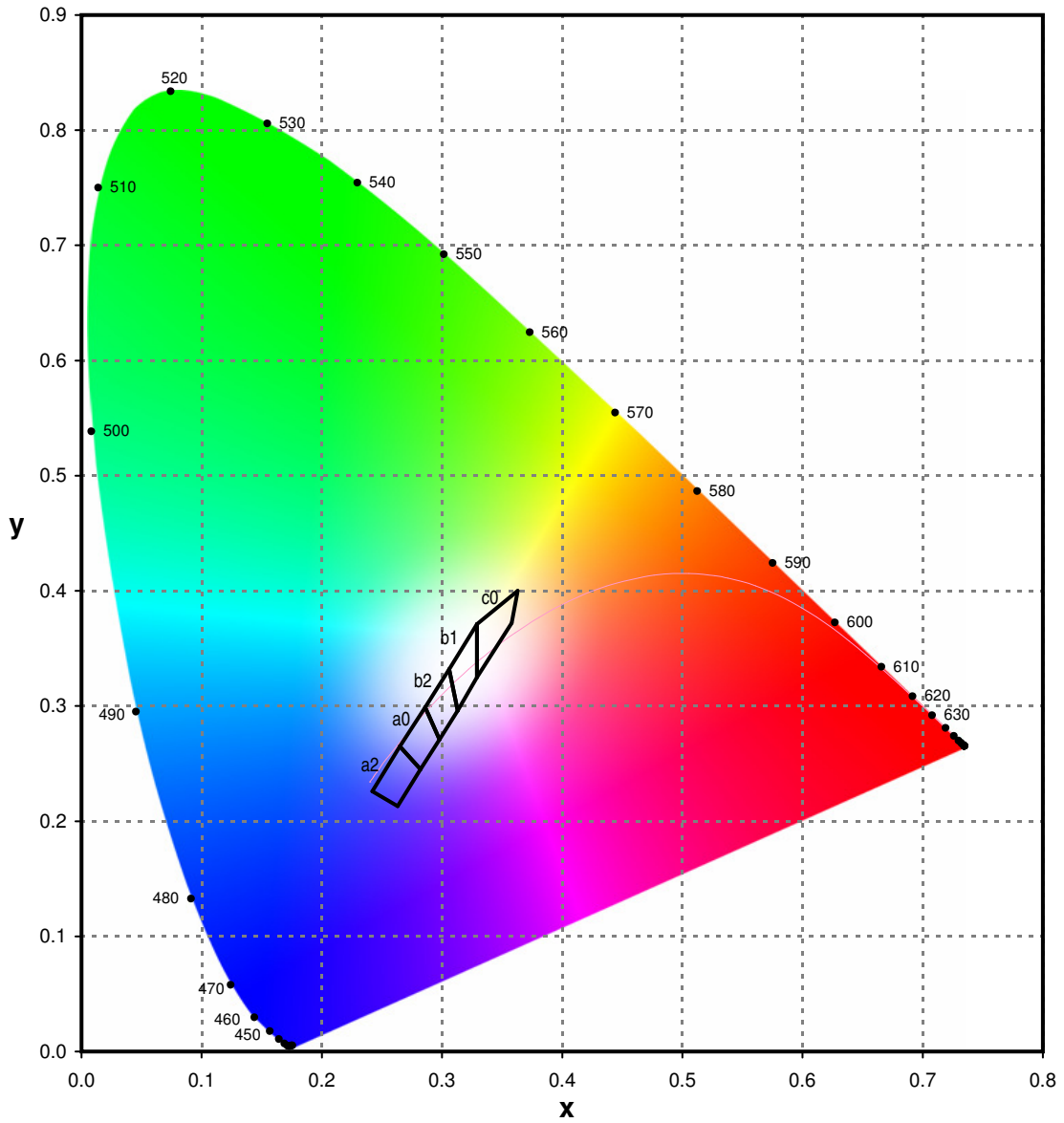

Bin	x	y
a2	0.263	0.213
	0.282	0.245
	0.265	0.265
	0.242	0.226
CCT: 15000K~		

Bin	x	y
b2	0.298	0.271
	0.313	0.296
	0.306	0.332
	0.286	0.299
CCT: 6800~9000K		

Bin	x	y
c0	0.329	0.325
	0.358	0.372
	0.363	0.400
	0.329	0.371
CCT: 4600~5600K		

Bin	x	y
a0	0.282	0.245
	0.298	0.271
	0.286	0.299
	0.265	0.265
CCT: 9000~15000K		

Bin	x	y
b1	0.313	0.296
	0.329	0.325
	0.329	0.371
	0.306	0.332
CCT: 5600~6800K		

### CIE CHROMATICITY DIAGRAM

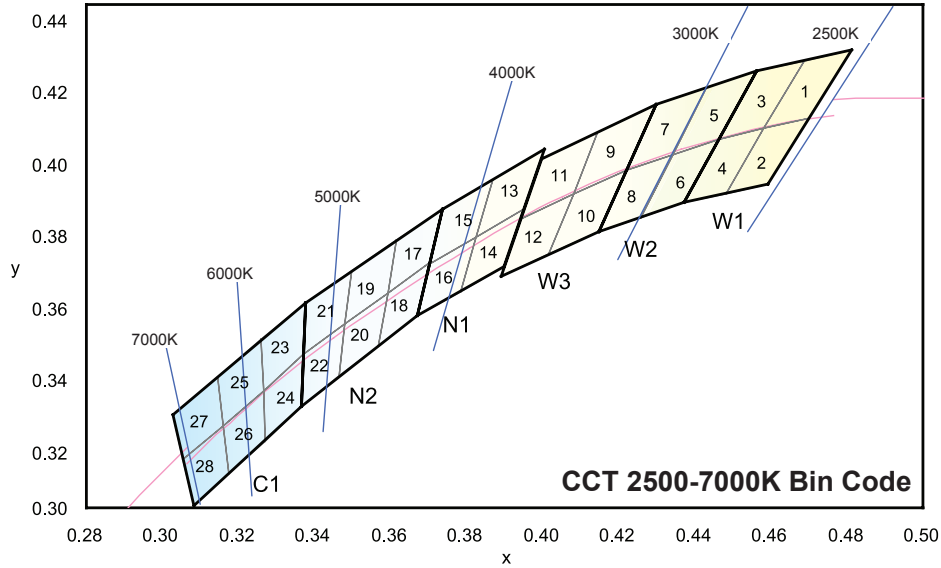

Group	Chromaticity Regions	CCT (K)		
		Min.	Typ.	Max.
W1	1, 2, 3, 4	2580	2700	2870
W2	5, 6, 7, 8	2870	3000	3220
W3	9, 10, 11, 12	3220	3500	3710

Group	Chromaticity Regions	CCT (K)		
		Min.	Typ.	Max.
N1	13, 14, 15, 16	3710	4000	4260
N2	17, 18, 19, 20, 21, 22	4260	4700	5310
C1	23, 24, 25, 26, 27, 28	5310	6000	7040

	x	y		x	y		x	y		x	y
1	0.4582	0.4099	8	0.4147	0.3814	15	0.3702	0.3722	22	0.3481	0.3557
	0.4687	0.4289		0.4221	0.3984		0.3736	0.3874		0.3370	0.3472
	0.4813	0.4319		0.4342	0.4028		0.3869	0.3958		0.3364	0.3328
	0.4700	0.4126		0.4259	0.3853		0.3825	0.3798		0.3466	0.3411
2	0.4483	0.3919	9	0.4080	0.3916	16	0.3670	0.3578	23	0.3376	0.3616
	0.4582	0.4099		0.4146	0.4089		0.3702	0.3722		0.3260	0.3512
	0.4700	0.4126		0.4299	0.4165		0.3825	0.3798		0.3265	0.3371
	0.4593	0.3944		0.4221	0.3984		0.3783	0.3646		0.3370	0.3472
3	0.4465	0.4071	10	0.4017	0.3751	17	0.3736	0.3874	24	0.3370	0.3472
	0.4562	0.4260		0.4080	0.3916		0.3616	0.3788		0.3265	0.3371
	0.4687	0.4289		0.4221	0.3984		0.3592	0.3641		0.3270	0.3230
	0.4582	0.4099		0.4147	0.3814		0.3703	0.3726		0.3364	0.3328
4	0.4373	0.3893	11	0.3941	0.3848	18	0.3703	0.3726	25	0.3260	0.3512
	0.4465	0.4071		0.3996	0.4015		0.3592	0.3641		0.3144	0.3408
	0.4582	0.4099		0.4146	0.4089		0.3568	0.3495		0.3160	0.3274
	0.4483	0.3919		0.4080	0.3916		0.3670	0.3578		0.3265	0.3371
5	0.4342	0.4028	12	0.3889	0.3690	19	0.3616	0.3788	26	0.3265	0.3371
	0.4430	0.4212		0.3941	0.3848		0.3496	0.3702		0.3160	0.3274
	0.4562	0.4260		0.4080	0.3916		0.3481	0.3557		0.3175	0.3139
	0.4465	0.4071		0.4017	0.3751		0.3592	0.3641		0.3270	0.3230
6	0.4259	0.3853	13	0.3825	0.3798	20	0.3592	0.3641	27	0.3144	0.3408
	0.4342	0.4028		0.3869	0.3958		0.3481	0.3557		0.3028	0.3304
	0.4465	0.4071		0.4006	0.4044		0.3466	0.3411		0.3055	0.3177
	0.4373	0.3893		0.3950	0.3875		0.3568	0.3495		0.3160	0.3274
7	0.4221	0.3984	14	0.3783	0.3646	21	0.3496	0.3702	28	0.3160	0.3274
	0.4299	0.4165		0.3825	0.3798		0.3376	0.3616		0.3055	0.3177
	0.4430	0.4212		0.3950	0.3875		0.3370	0.3472		0.3081	0.3049
	0.4342	0.4028		0.3898	0.3716		0.3481	0.3557		0.3175	0.3139

INDEX

BA04-11 SERIES .....	52	KAA-3528AVU/ARBGS-112 .....	79	KCSX02 SERIES .....	40	KPS-3227SP1C.....	24
BA56-11 SERIES .....	53	KAA-3528RGRS-K11-C8-CC .....	6	KCSX03 SERIES .....	40	KPS-5130PD7C.....	24
BA56-12 SERIES .....	53	KAAF-3529BGRS-132 .....	6	KCSX04 SERIES .....	41	KPT-1608 SERIES .....	9
BA56-13 SERIES .....	53	KAAF-5050RGRS-13 .....	6	KCSX39 SERIES .....	41	KPT-2012 SERIES .....	11
BC04-11 SERIES .....	52	KB-2300SEKW .....	70	KCSX51 SERIES.....	42	KPT-3216 SERIES .....	12
BC56-11 SERIES .....	53	KB-2350SEKW .....	70	KCSX56 SERIES .....	42	KPTB-1612 SERIES.....	17
BC56-12 SERIES .....	53	KB-2400SYKW .....	70	KM-23ESGC.....	19	KPTB-1615 SERIES.....	18
BC56-13 SERIES .....	53	KB-2450SYKW .....	70	KM-23-F SERIES .....	23	KPTBD-3216 SERIES .....	20
BL0102-14-34 .....	86	KB-2500CGKD .....	70	KM2520EH/1 SERIES .....	72	KPTC-3212 SERIES .....	12
BL0307-50-44.....	86	KB-2550CGKD .....	70	KM2520F3C03 .....	82	KPTD-1608 SERIES.....	10
BL0307-50-46.....	86	KB-2600SEKW .....	70	KM2520QBC-D08 .....	23	KPTD-3216 SERIES.....	13
CA04-41 SERIES .....	55	KB-2620SEKW .....	71	KM2520xxx01 SERIES.....	26	KPTF-1616RGBC-11 .....	4
CA25-11 SERIES .....	54	KB-2635SEKW .....	71	KM2520xxx03 SERIES .....	22	KPTL-3216 SERIES .....	13
CA25-12 SERIES .....	54	KB-2655SEKW .....	70	KM2520xxx09 SERIES.....	23	KPTR-3216 SERIES.....	21
CA56-11 SERIES .....	56	KB-2670SEKW .....	71	KP-1608 SERIES .....	10	KRA021 .....	92
CA56-12 SERIES .....	56	KB-2685SEKW .....	71	KP-1608F3C .....	82	KRB031 .....	92
CA56-21 SERIES .....	56	KB-2700SYKW .....	70	KP-1608P1C .....	84	KRC011 .....	93
CB-30 .....	80	KB-2720SYKW .....	71	KP-1608SF4C .....	82	KTDS-3536 SERIES.....	3
CB-50 .....	80	KB-2735SYKW .....	71	KP-2012 SERIES .....	11	KTIR0311S .....	91
CB-55 .....	80	KB-2755SYKW .....	70	KP-2012F3C .....	82	KTIR0411S .....	91
CC04-41 SERIES .....	55	KB-2770SYKW .....	71	KP-2012P3C .....	84	KTIR0511S .....	91
CC25-11 SERIES .....	54	KB-2785SYKW .....	71	KP-2012SF4C .....	82	KTIR0611S .....	91
CC25-12 SERIES .....	54	KB-2800CGKD .....	70	KP-3216 SERIES .....	13	KTIR0711S .....	93
CC56-11 SERIES .....	56	KB-2820CGKD .....	71	KP-3216P3C .....	84	KTIR0721DS .....	93
CC56-12 SERIES .....	56	KB-2835CGKD .....	71	KPA-1606 SERIES .....	15	KTIR0811S .....	93
CC56-21 SERIES .....	56	KB-2855CGKD .....	70	KPA-2107 SERIES .....	15	KTIR0821DS .....	93
DA03-11 SERIES .....	50	KB-2870CGKD .....	71	KPA-3010 SERIES .....	15	KTIR0911S .....	92
DA04-11SERIES .....	50	KB-2885CGKD .....	71	KPA-3010F3C .....	82	L-103 SERIES .....	32
DA08-11 SERIES .....	52	KB3541NT .....	89	KPA-3010P3C .....	84	L-1034 SERIES .....	30
DA56-11 SERIES .....	51	KB354NT .....	89	KPA-3210 SERIES .....	16	L-1043 SERIES .....	69
DA56-51 SERIES .....	51	KB355NT .....	88	KPB-3025 SERIES.....	19	L-10934VBC/DS-D .....	25
DC03-11SERIES .....	50	KB356NT .....	89	KPBA-3010 SERIES.....	18	L-113 SERIES .....	32
DC04-11SERIES .....	50	KB357NT .....	89	KPBD-3224 SERIES .....	20	L-1154 SERIES .....	26
DC-05 SERIES .....	68	KB814 .....	87	KPBDA-3020SURKCGKC-PF .....	19	L-115V SERIES .....	33
DC08-11 SERIES .....	52	KB8141 .....	87	KPBL-3025 SERIES.....	19	L-115W SERIES .....	34
DC-10 SERIES.....	68	KB815 .....	87	KPC-1608 SERIES .....	10	L-117EGWT .....	36
DC-20/20 SERIES.....	68	KB816 .....	87	KPD-3224 SERIES.....	14	L-119EGWT .....	36
DC56-11 SERIES .....	51	KB817 .....	87	KPED-3528 SERIES .....	14	L-13 SERIES .....	30
DC56-51 SERIES .....	51	KB817-B .....	88	KPFA-2507BRGC-11.....	5	L-130WARA/1 SERIES .....	73
DD-12 SERIES .....	68	KB817-M .....	88	KPFA-3010RGBC-11.....	5	L-130WCP/2 SERIES .....	76
DE/2 SERIES .....	69	KB851 .....	88	KPFA-3011BZ1RGZ1C-132/F .....	5	L-130WDT/1 SERIES .....	73
DE/4 SERIES .....	69	KB852 .....	88	KPG-0603 SERIES .....	7	L-132X SERIES.....	27
DF-3 SERIES .....	69	KB-A100SURKW .....	70	KPG-1005 SERIES .....	7	L-1384AD/1 SERIES .....	73
DLA/6 SERIES .....	29	KB-B100SURKW .....	70	KPG1-1608 SERIES .....	8	L-1384AL/1 SERIES .....	74
DLC/6 SERIES .....	29	KB-C100SURKW .....	70	KPG-1608 SERIES.....	8	L-1387QMP/1 SERIES .....	79
KA-2214 SERIES .....	21	KB-D100SURKW .....	70	KPG-1608 SERIES .....	8	L-138A8QMP/1 SERIES .....	79
KA-2810A SERIES .....	16	KB-E100SURKW .....	71	KPGA-1602 SERIES .....	14	L-144 SERIES .....	31
KA-3021 SERIES .....	21	KB-F100SURKW .....	71	KPGF-0606GBRC-120.....	4	L-1503 SERIES .....	29
KA-3022CGSK-4.5SF.....	22	KB-G100SURKW .....	71	KPGF-1011GBRC-120 .....	4	L-1503EB/2 SERIES .....	77
KA3030BR34-S2 .....	3	KB-H100SURKW .....	71	KPH-1608 SERIES.....	9	L-150A9VS/1 SERIES .....	74
KA-3528 SERIES .....	22	KCDX02 SERIES .....	40	KPHB-1608 SERIES .....	17	L-1533BQ/1 SERIES .....	74
KA-3528AVU/ SERIES .....	79	KCDX03 SERIES .....	40	KPHBM-2012 SERIES .....	18	L-154A4 SERIES .....	35
KA-3529A SERIES .....	2	KCDX04 SERIES .....	41	KPHCM-2012 SERIES .....	11	L-1553 SERIES .....	32
KA-3535 SERIES .....	2	KCDX39 SERIES .....	41	KPHD-1608 SERIES .....	9	L-169X SERIES .....	31
KA-4008 SERIES .....	16	KCDX51 SERIES .....	42	KPHHS-1005 SERIES .....	7	L-17114VBC/DS-D .....	25
KA-4040 SERIES .....	17	KCDX56 SERIES .....	42	KPHM-1608 SERIES .....	8	L-174A2 SERIES.....	27
KA-5630 SERIES .....	2	KCPDX04 SERIES .....	43	KPL-3015 SERIES .....	12	L-19294VBC/DS-D .....	25
KAA-3528 SERIES.....	20	KCPSX04 SERIES .....	43	KPPA-3010 SERIES.....	15	L-19804VBC/DS-D .....	25

## INDEX

L-2774 SERIES .....	30	L-7676C SERIES .....	38	SA40-19 SERIES .....	49	TBA40-11 SERIES .....	67
L-34 SERIES .....	27	L-7679C1 SERIES .....	38	SA43-11 SERIES .....	45	TBC12-11 SERIES .....	61
L-34F3C .....	83	L-793 SERIES .....	29	SA43-13 SERIES .....	45	TBC12-12 SERIES .....	61
L-34SF4C .....	83	L-813 SERIES .....	29	SA52-11 SERIES .....	46	TBC12-22 SERIES .....	62
L-36B SERIES .....	38	L-819 SERIES .....	35	SA56-11 SERIES .....	46	TBC15-11 SERIES .....	63
L-3DP3BT .....	85	L-835/2 SERIES .....	69	SA56-21 SERIES .....	46	TBC20-11 SERIES .....	64
L-3V SERIES .....	34	L-908A8 SERIES .....	26	SBA15-11 SERIES .....	48	TBC20-12 SERIES .....	64
L-4060 SERIES .....	26	L-914 SERIES .....	31	SBA18-11 SERIES .....	48	TBC20-22 SERIES .....	64
L-4060VH/2 SERIES .....	75	L-914CK/4 SERIES .....	78	SBA23-11 SERIES .....	49	TBC23-11 SERIES .....	65
L-4060XHA/3 SERIES .....	77	L-91A6 SERIES .....	35	SBC15-11 SERIES .....	48	TBC23-12 SERIES .....	65
L-424 SERIES .....	33	L-91A7 SERIES .....	31	SBC18-11 SERIES .....	48	TBC24-11 SERIES .....	66
L-42WUM/1 SERIES .....	73	L-9294 SERIES .....	28	SBC23-11 SERIES .....	49	TBC24-22 SERIES .....	66
L-43 SERIES .....	28	L-937 SERIES .....	33	SC03-12 SERIES .....	44	TBC40-11 SERIES .....	67
L-47X SERIES .....	32	L-96A8YVP/1QBD-D-0L .....	78	SC04-11 SERIES .....	45	TC07-11 SERIES .....	60
L-483 SERIES .....	33	L-9763 SERIES .....	31	SC04-12 SERIES .....	45	TC12-11 SERIES .....	61
L-489EGWT .....	36	PDA54-11 SERIES .....	59	SC05-11 SERIES .....	46	TC12-22 SERIES .....	62
L-5603 SERIES .....	30	PDA54-12 SERIES .....	59	SC08-11 SERIES .....	47	TC12-23 SERIES .....	62
L-56B SERIES .....	38	PDC54-11 SERIES .....	59	SC08-12 SERIES .....	47	TC15-11 SERIES .....	63
L-57 SERIES .....	34	PDC54-12 SERIES .....	59	SC08-21 SERIES .....	47	TC16-11 SERIES .....	60
L-59 SERIES .....	35	PSA05-11 SERIES .....	57	SC10-11 SERIES .....	47	TC20-11 SERIES .....	64
L-59BL/1 SERIES .....	74	PSA05-12 SERIES .....	57	SC10-21 SERIES .....	47	TC23-11 SERIES .....	65
L-59CB/1 SERIES .....	75	PSA08-11 SERIES .....	57	SC15-11 SERIES .....	48	TC24-11 SERIES .....	66
L-59-TNR2.54 .....	39	PSA08-12 SERIES .....	57	SC18-11 SERIES .....	48	TC40-11 SERIES .....	67
L-63 SERIES .....	28	PSA12-11 SERIES .....	58	SC23-11 SERIES .....	49		
L-7104 SERIES .....	27	PSA23-11 SERIES .....	58	SC23-12 SERIES .....	49		
L-7104EB/2 SERIES .....	75	PSC05-11 SERIES .....	57	SC32-11 SERIES .....	44		
L-7104F3BT .....	83	PSC05-12 SERIES .....	57	SC36-11 SERIES .....	44		
L-7104F3C .....	83	PSC08-11 SERIES .....	57	SC39-11 SERIES .....	45		
L-7104GO/2 SERIES .....	75	PSC08-12 SERIES .....	57	SC39-12 SERIES .....	45		
L-7104L SERIES .....	37	PSC12-11 SERIES .....	58	SC40-18 SERIES .....	49		
L-7104MD/2 SERIES .....	76	PSC23-11 SERIES .....	58	SC40-19 SERIES .....	49		
L-7104RS/1 SERIES .....	72	REEL DIMENSION .....	39	SC43-11 SERIES .....	45		
L-7104RT/2 SERIES .....	76	RTC-31 .....	80	SC43-13 SERIES .....	45		
L-7104SA/3 SERIES .....	77	RTC-32 .....	80	SC52-11 SERIES .....	46		
L-7104SB/4 SERIES .....	78	RTC-51 .....	80	SC56-11 SERIES .....	46		
L-7104-TNR2.54 .....	39	RTC-52 .....	80	SC56-21 SERIES .....	46		
L-7104xxD-12V SERIES .....	37	RTF-1090 .....	81	TA03-11 SERIES .....	60		
L-7104xxD-14V SERIES .....	37	RTF-5010 .....	81	TA07-11 SERIES .....	60		
L-7104xxD-5V SERIES .....	37	RTF-5020 .....	81	TA12-11 SERIES .....	61		
L-7104ZH/1 SERIES .....	72	RTF-8080 .....	81	TA12-22 SERIES .....	62		
L-710A8CB/1 SERIES .....	72	SA03-11 SERIES .....	44	TA12-23 SERIES .....	62		
L-7113 SERIES .....	28	SA04-11 SERIES .....	45	TA15-11 SERIES .....	63		
L-7113BR-12.7/ SERIES .....	78	SA04-12 SERIES .....	45	TA16-11 SERIES .....	60		
L-7113BR-9.52/ SERIES .....	78	SA05-11 SERIES .....	46	TA20-11 SERIES .....	64		
L-7113F3BT .....	83	SA08-11 SERIES .....	47	TA23-11 SERIES .....	65		
L-7113F3C .....	83	SA08-12 SERIES .....	47	TA24-11 SERIES .....	66		
L-7113L SERIES .....	37	SA08-21 SERIES .....	47	TA40-11 SERIES .....	67		
L-7113P3C .....	85	SA10-11 SERIES .....	47	TBA12-11 SERIES .....	61		
L-7113SF4BT .....	83	SA10-21 SERIES .....	47	TBA12-12 SERIES .....	61		
L-7113SF4C .....	83	SA15-11 SERIES .....	48	TBA12-22 SERIES .....	62		
L-7113SF6C .....	83	SA18-11 SERIES .....	48	TBA15-11 SERIES .....	63		
L-7113SF7C .....	83	SA23-11 SERIES .....	49	TBA20-11 SERIES .....	64		
L-7113SRSGW .....	34	SA23-12 SERIES .....	49	TBA20-12 SERIES .....	64		
L-7113-TNR2.54 .....	39	SA32-11 SERIES .....	44	TBA20-22 SERIES .....	64		
L-7113xxD-12V SERIES .....	37	SA36-11 SERIES .....	44	TBA23-11 SERIES .....	65		
L-7113xxD-5V SERIES .....	37	SA39-11 SERIES .....	45	TBA23-12 SERIES .....	65		
L-7143 SERIES .....	29	SA39-12 SERIES .....	45	TBA24-11 SERIES .....	66		
L-73EB/2 SERIES .....	76	SA40-18 SERIES .....	49	TBA24-22 SERIES .....	66		



## X-ON Electronics

Largest Supplier of Electrical and Electronic Components

*Click to view similar products for [LED Circuit Board Indicators](#) category:*

*Click to view products by [Kingbright](#) manufacturer:*

Other Similar products are found below :

[568-0200-132F](#) [568-0701-841F](#) [568-0734-832F](#) [569-0312-300F](#) [591-2001-107F](#) [592-2222-302F](#) [592-2424-302F](#) [LTL-4221NH129](#) [LTL-42DGNMHDP1](#) [LTM-260-5HT](#) [H131CSRT-120](#) [HLMP1503108F](#) [HLMP1521101](#) [HLMP1523802F](#) [HLMP1700101F](#) [HLMP1700104F](#) [HLMP1790105F](#) [BHA-1564-G](#) [SMF-HM1530YD-305](#) [SSF-LXH103SUGD-04](#) [AM2520EHSGD](#) [HLMP1301104F](#) [HLMP1385101F](#) [HLMP1421101](#) [HLMP1503103F](#) [HLMP1503104F](#) [HLMP1700102F](#) [HLMP1700106F](#) [HLMP1700107F](#) [HLMP1790101F](#) [HLMP1790103F](#) [LTL-4211NHBP](#) [5320F7](#) [5330H7](#) [5350T7](#) [5352T1-5VLC](#) [5352T5-5VLC](#) [5370T7LC](#) [550-1112F](#) [550-3107-010F](#) [551-0206-003F](#) [551-0207-815F](#) [551-0212-801F](#) [551-2802F](#) [552-0794-810F](#) [552-0821F](#) [552-6033-200F](#) [553-0001-808F](#) [553-0122-818F](#) [553-0171F](#)