

Part Number: L-1533BQ/1GD

Green

Features

- Pre-trimmed leads for pc mounting.
- Black case enhances contrast ratio.
- Wide viewing angle.
- High reliability - life measured in years.
- Housing UL rating:94V-0.
- Housing material: type 66 nylon.
- RoHS compliant.

Description

The Green source color devices are made with Gallium Phosphide Green Light Emitting Diode.

Package Dimensions

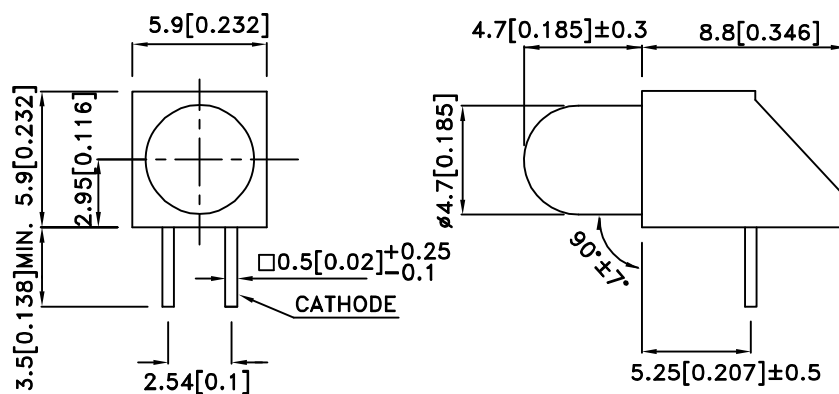

Notes:

1. All dimensions are in millimeters (inches).
2. Tolerance is ±0.25(0.01") unless otherwise noted.
3. Lead spacing is measured where the leads emerge from the package.
4. The specifications, characteristics and technical data described in the datasheet are subject to change without prior notice.



Selection Guide

Part No.	Dice	Lens Type	Iv (mcd) [2] @ 10mA		Viewing Angle [1]
			Min.	Typ.	2θ1/2
L-1533BQ/1GD	Green (GaP)	Green Diffused	20	50	60°

Notes:

1. θ1/2 is the angle from optical centerline where the luminous intensity is 1/2 of the optical peak value.
2. Luminous intensity/ luminous Flux: +/-15%.
3. Luminous intensity value is traceable to the CIE127-2007 compliant national standards.

Electrical / Optical Characteristics at TA=25°C

Symbol	Parameter	Device	Typ.	Max.	Units	Test Conditions
λ _{peak}	Peak Wavelength	Green	565		nm	I _F =20mA
λ _D [1]	Dominant Wavelength	Green	568		nm	I _F =20mA
Δλ _{1/2}	Spectral Line Half-width	Green	30		nm	I _F =20mA
C	Capacitance	Green	15		pF	V _F =0V;f=1MHz
V _F [2]	Forward Voltage	Green	2.2	2.5	V	I _F =20mA
I _R	Reverse Current	Green		10	uA	V _R = 5V

Notes:

- 1.Wavelength: +/-1nm.
2. Forward Voltage: +/-0.1V.
- 3.Wavelength value is traceable to the CIE127-2007 compliant national standards.

Absolute Maximum Ratings at TA=25°C

Parameter	Green	Units
Power dissipation	62.5	mW
DC Forward Current	25	mA
Peak Forward Current [1]	140	mA
Reverse Voltage	5	V
Operating/Storage Temperature	-40°C To +85°C	
Lead Solder Temperature [2]	260°C For 3 Seconds	
Lead Solder Temperature [3]	260°C For 5 Seconds	

Notes:

1. 1/10 Duty Cycle, 0.1ms Pulse Width.
2. 2mm below package base.
3. 5mm below package base.



Green

L-1533BQ/1GD

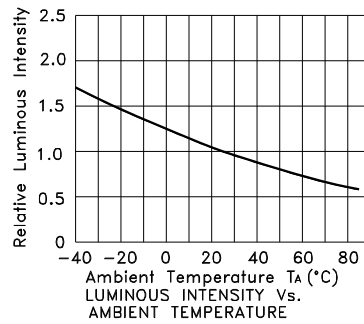

Kingbright

PACKING & LABEL SPECIFICATIONS

L-1533BQ/1GD

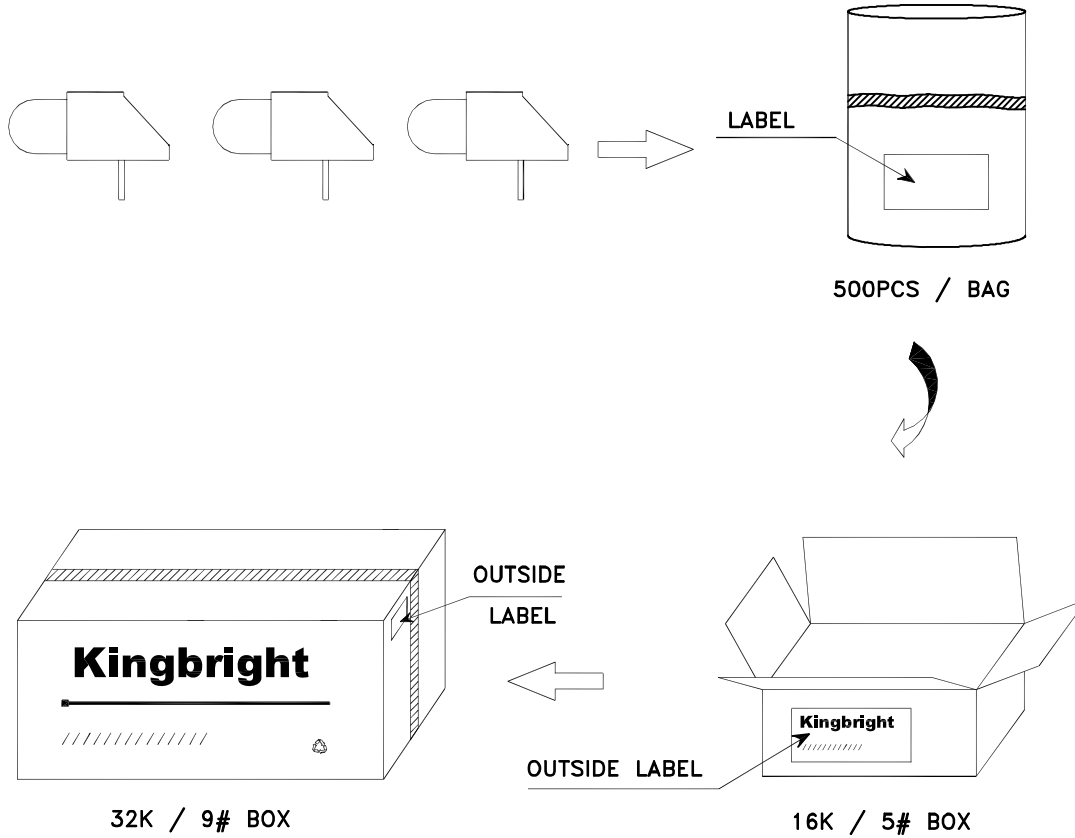

<h1>Kingbright</h1>					
P/NO: L-1533BQxxx					
QTY: 500 pcs	Q.C.	<table border="1"> <tr> <td>Q C</td> </tr> <tr> <td>XX XX XXXX</td> </tr> <tr> <td>PASSED</td> </tr> </table>	Q C	XX XX XXXX	PASSED
Q C					
XX XX XXXX					
PASSED					
S/N: XXXX					
CODE: XXX					
LOT NO:					
					
xxxxxxxxxxxxxxxxxxxxxxxxxxxxxxxx					
RoHS Compliant					

PRECAUTIONS

- The lead pitch of the LED must match the pitch of the mounting holes on the PCB during component placement. Lead-forming may be required to insure the lead pitch matches the hole pitch. Refer to the figure below for proper lead forming procedures.

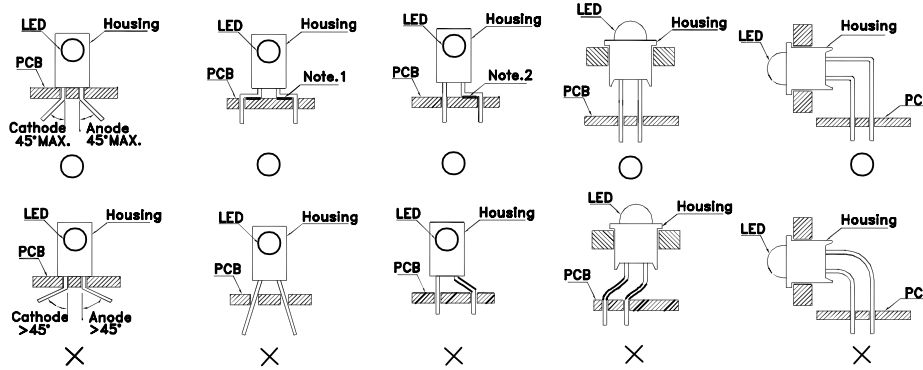

"O" Correct mounting method "X" Incorrect mounting method

- During soldering, component covers and holders should leave clearance to avoid placing damaging stress on the LED during soldering.

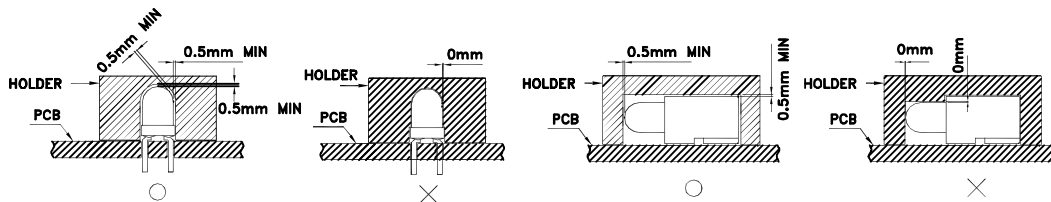

- The tip of the soldering iron should never touch the lens epoxy.
- Through-hole LEDs are incompatible with reflow soldering.
- If the LED will undergo multiple soldering passes or face other processes where the part may be subjected to intense heat, please check with Kingbright for compatibility.
- Recommended Wave Soldering Profiles:

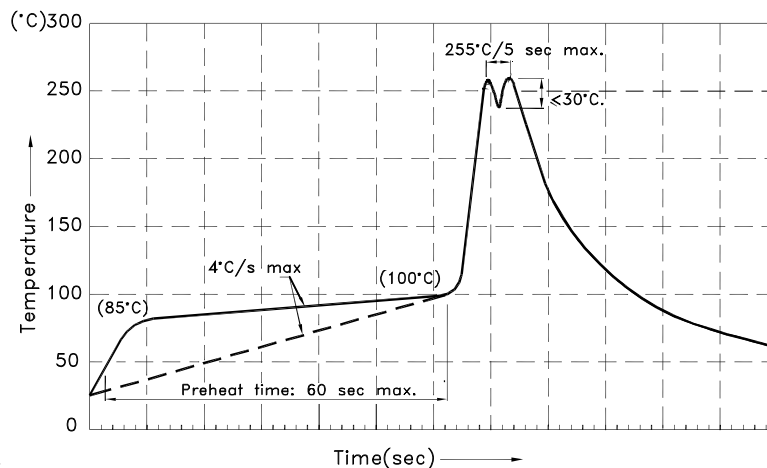

Notes:

- Recommend pre-heat temperature of 105°C or less (as measured with a thermocouple attached to the LED pins) prior to immersion in the solder wave with a maximum solder bath temperature of 260°C
- Peak wave soldering temperature between 245°C ~ 255°C for 3 sec (5 sec max).
- Do not apply stress to the epoxy resin while the temperature is above 85°C.
- Fixtures should not incur stress on the component when mounting and during soldering process.
- SAC 305 solder alloy is recommended.
- No more than one wave soldering pass.

Detailed application notes are listed on our website.

http://www.kingbright.com/application_notes

X-ON Electronics

Largest Supplier of Electrical and Electronic Components

Click to view similar products for [LED Panel Mount Indicators](#) category:

Click to view products by [Kingbright](#) manufacturer:

Other Similar products are found below :

[607-1312-310F](#) [607-3232-140F](#) [6091M1-24V](#) [6091M5-24V](#) [6091M7-24V](#) [821-0331-503](#) [FL2870C8R](#) [FL2950WL7B](#) [FL589WL8R](#)
[Q6P3BXXB12E](#) [H8630FBBA3](#) [MPC5ADW6.0](#) [DX1091GN](#) [NL177WL3G](#) [NL276C3G](#) [NL2950BWL3G](#) [NL2950CWL2R](#) [NL589WL2R](#)
[NL67C3G](#) [NL67C3R](#) [2191L1-12V](#) [PB22SIOL0RG](#) [PB22SPPM41R](#) [PB22SPPM61R](#) [LE177C5B](#) [LH1048BSWL3702](#) [LH1048BWL3702](#)
[LH382A](#) [LHM62B](#) [SSI-LXH387USBD-150](#) [SSI-LXH9ZIC40587](#) [SSP-LXS110818BA](#) [FL2950BWL7R](#) [FL2950WL7R](#) [FL2951WL8G](#)
[FL2951WL8R](#) [FL589C7R](#) [FL67C7R](#) [FL67WL8G](#) [2191QU7-24V](#) [2191U1-12V](#) [2191U5-12V](#) [2191U5-6V](#) [2191U7-12V](#) [249-4167-3734-504F](#) [Q6P5BXXG02E](#) [3990A7](#) [5110F3-12V](#) [MPC5BCW18.0](#) [556-1237-801F](#)