

PRODUCT NO.
SEE SHT.2

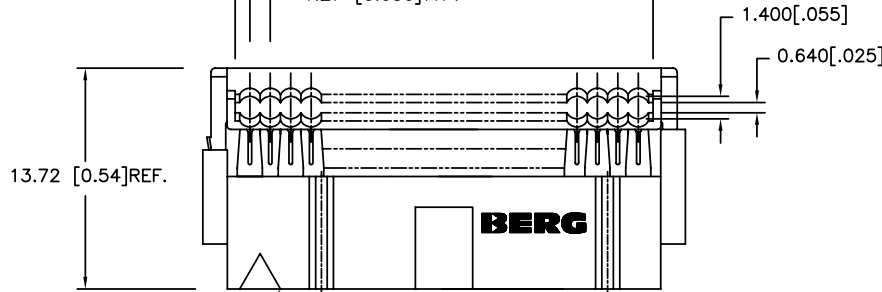

TRIANGLE INDICATES POSITION ONE

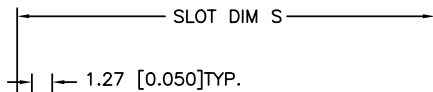
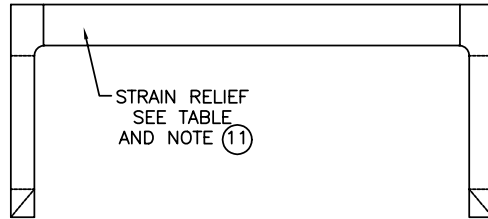
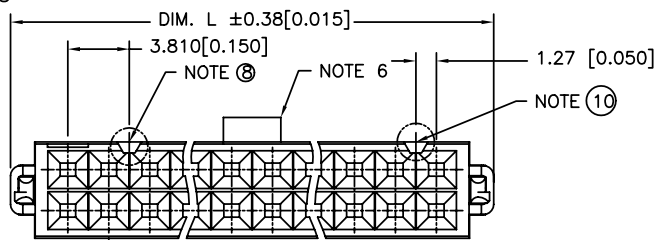

SIDE VIEW OF ASS'Y.
AFTER TERMINATION

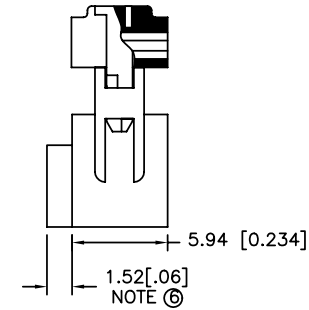
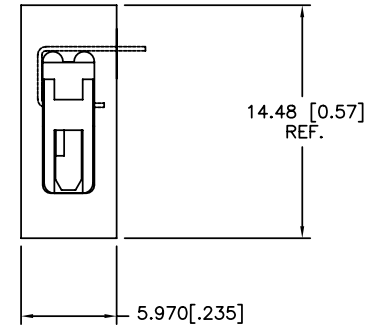

Copyright FCI.

mat'l. code				tolerances unless otherwise specified			CUSTOMER COPY	FCI www.fciconnect.com	
ltr	ecn no	dr	date	linear	.xx ±.01/.x±.3	projection 	title		
G	5003	BLI	1983-08-02	angles	.xxx ±.005/.xxx±.13		QUICKIE L.P ASS'Y STRAIN RELIEF		
H	N10816	CN	1988-10-05		.xxx ±.0020/.xxx±.051	INCH/MM ↔	product family QUICKIE		
J	V81770	RGD	1998-10-02		0° ±2°		code NT		
K	V90536	RGD	1999-03-02	dr	R.G. DRAGG00	10/2/98	size		
L	N05-0060	MHT	2005-03-04	engr	M.SYMK	10/2/98	dwg no		
M	N09-0400	A.ZH	2010-01-18	chr	M.SYMK	10/2/98	sheet		
				appd	M.SYMK	10/2/98	1 of 2		
sheet index	revision sheet	M					scale		
	1-2						1:1	A4	

PRODUCT NO.	SIZE	DIM "L"	DIM "S"	LEAD FREE OPTION
66564-X06	2x3	12.19/[.480]	8.128/[.320]	NOTE 13, 14
66564-X08	2x4	14.73/[.580]	10.668/[.420]	
66564-X10	2x5	17.27/[.680]	13.210/[.520]	
-X14	2x7	22.35/[.880]	18.290/[.720]	
-X16	2x8	24.89/[.980]	20.830/[.820]	
-X20	2x10	29.97/[1.180]	25.910/[1.020]	
-X26	2x13	37.59/[1.480]	33.530/[1.320]	
-X34	2x17	47.75/[1.880]	43.690/[1.720]	
-X40	2x20	55.37/[2.180]	51.310/[2.020]	
-X50	2x25	68.07/[2.680]	64.010/[2.520]	
66564-X60	2x30	80.77/[3.180]	76.710/[3.020]	

KEY	X	COVER		POL. KEY	STR REL.	SEE NOTE 12
		STYLE	ENTRY			
5	THRU	DUAL	NO	NO	NO	SEE NOTE 11
6	THRU	DUAL	NO	NO	NO	SEE NOTE 11
7	THRU	DUAL	YES	NO	NO	SEE NOTE 11
8	THRU	DUAL	YES	YES		
9	THRU	DUAL	NO	YES		

NOTES:

1. TERMINAL MAT'L: PHOS BRONZE, FULL HARD, ALLOY UNS-C51000.
2. TERMINAL PLATING: 50u"/1.27um MIN Ni UNDERPLATE OVER ENTIRE TERMINAL AND 30u"/0.76um MIN Au OR GXT IN CONTACT AREA ONLY;
3. MOLDING MAT'L: BASE AND COVER-GLASS FILLED POLYESTER, FLAME RETARDANT PER UL 94V-0: COLOR- BLUE.
4. CONNECTOR ASS'YS PACKAGED IN TUBESTHEN BOXED IN LOTS OF 100.
5. THE FIRST TWO CAVITY POSITIONS AND THE LAST TWO ARE IDENTIFIED BY NUMBER.
6. POLARIZING FEATURE OPTIONAL , SEE TABLE.
7. MOLDING MAT'L: STRAIN RELIEF-UNFILLED THERMOPLASTIC, FLAME-RETARDANT:UL 94 V-0: COLOR-BLUE.
8. THE POLARIZING FEATURE ON THIS END IS NON EXISTENT ON 6,8,10, AND 14 POS. CONNECTORS.
9. 10 POSITION CONNECTOR NOT AVAILABLE WITH BOTH POL. SLOTS AND KEY.
10. THE POLARIZING FEATURE ON THIS END IS NON EXISTENT ON 6 AND 8 POS. CONNECTORS.
11. THE PRODUCT NUMBERS 66564-6XX AND 66564-7XX ONLY COUNT FOR 2x3 AND 2x4 POS. CONNECTORS FOR ALL OTHER VERSIONS WITHOUT STRAIN RELIEF (2x5---2x30) REFER TO P/N 66900
12. PRODUCT NUMBER 66564-506 ONLY WITHOUT BERG LOGO.
13. ADD "LF" SUFFIX AT THE END OF PART NUMBER FOR LEAD FREE OPTION.
14. THESE PRODUCTS MEET EUROPEAN UNION DIRECTIVES AND OTHER COUNTRY REGULATION AS DESCRIBED IN GS-22-008.
15. THE PRODUCT IS NOT INTENDED TO BE EXPOSED TO A MANUFACTURING SOLDER PROCESS.
16. PRODUCT SPEC. BUS-12-082
17. PLATING OPTIONS: MAY BE EITHER GOLD OR GXT PLATED AT MANUFACTURER'S OPTION.

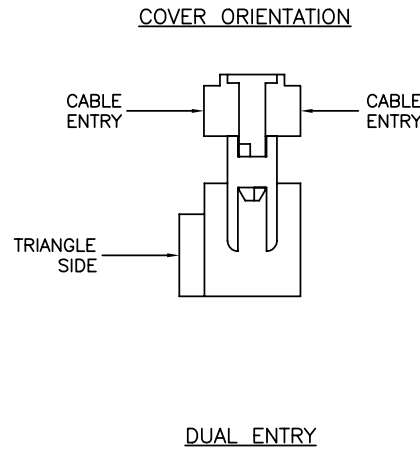

Copyright FCI.

tolerances unless otherwise specified		CUSTOMER COPY	FCI www.fciconnect.com	
linear	. XX ± .01/. Xt. 3	projection ⊕ ←	title QUICKIE L. P ASS'Y STRAIN RELIEF	
	. XXX ± .005/. XX±. 13		product family QUICKIE size dwg no	code NT
	. XXXX ± .0020/. XXX±. 051			sheet 2 of 2
angles	0° ±2°	INCH/MM	scale 1: 1	A4 66564
dr	R.G. DRAGGOO 10/2/98			
engr	M.SYMK 10/2/98			
chr	M.SYMK 10/2/98			
appd	M.SYMK 10/2/98			

X-ON Electronics

Largest Supplier of Electrical and Electronic Components

Click to view similar products for [Headers & Wire Housings](#) category:

Click to view products by [FCT Electronics](#) manufacturer:

Other Similar products are found below :

[95000-104TRLF](#) [10135584-644402LF](#) [DF62W-EP2022PCA](#) [95000-106TRLF](#) [DF62W-2022SCA](#) [DF62W-EP2022PC](#) [2203348](#) [DF62W-2022SC](#) [1084018](#) [1029039](#) [1084017](#) [802-10-012-10-002000](#) [1112640](#) [1112639](#) [891-007-9SS-BST1T](#) [000-34000](#) [0008550134](#) [0009482033](#) [0009507031](#) [57102-F02-18ULF](#) [57102-S06-03LF](#) [57202-S52-04LF](#) [PCN6-15S-2.5E](#) [0039019024](#) [58102-G61-06LF](#) [582553-1](#) [0009485154](#) [0009508121](#) [0022285053](#) [0050291907](#) [018731A](#) [LY20-4P-DT1-P1E-BR](#) [02.125.8002.8](#) [60101931](#) [60598-1 \(Cut Strip\)](#) [M1625-3R/100](#) [61062-3](#) [61082-181009](#) [CSU011177004](#) [636-1427](#) [638009-1](#) [641938-9](#) [641991-4](#) [644168-1](#) [644827-2](#) [647662-1](#) [65039-019ELF](#) [65692-001LF](#) [65781-018](#) [65781-047](#)