

LED-Indicators



LED-INDICATORS – red section

We offer a complete range of high-quality bracket indicators. Diodes are carefully selected for constant colour and brightness, housings are solid brass and chromium-plated.

LED-Indicators

Ø 7 mm



Ø 7 mm



Ø 10,5 mm



Ø 9 mm
superbright



Ø 12,2 mm
waterproof



Ø 7 mm
tricoloured



Ø 9 mm
tricoloured



Ø 9 mm
flashing



Ø 12,2 mm
waterproof



with lead and
connector



LED-Indicators

Specifications:									
Models	P Power dissipation (mW)	V _F ¹ Forward voltage (V)	I _F Forward current (mA)	I _V Luminous intensity (mcd) at I _F = 10 mA	λ _P Peak emission wavelength (nm) ¹	V _R Reverse voltage (V)	I _R Reverse current (μA) at V _R = 3 V	T _{OP} Operating temperature (°C)	
LD 30 LD 32	85	min. 2,1 typ. max. 3,0	20 25	1,8	700	5,0	100	- 40 + 85	
LD 34		min. 2,0 typ. max. 2,2	20 40	20 ⁴	630			4,0	10
LD 36 LDE 36 ³	100	min. 1,7 typ. max. 2,0	20 50	20 30	660	4,0	100	- 30 + 85	
LD 40 LD 42		min. 2,1 typ. max. 3,0	20 25	3,2	555			5,0	100
LD 44	110	min. 2,0 typ. max. 2,1	25 45	8 ⁴	565	4,0	10	- 30 + 70	
LD 46 LDE 46 ³		min. 2,1 typ. max. 2,5	20 50	8 12	555			4,0	100
LD 60 LD 62	85	min. 2,1 typ. max. 3,0	20 25	2,7	600	5,0	100	- 40 + 85	
LD 64		min. 2,1 typ. max. 2,2	35 50	10 ⁴	585			4,0	10
LD 66 LDE 66 ³	125	min. 2,2 typ. max. 2,5	20 50	16 24	580	4,0	100	- 30 + 85	
LD 70 LD 72		min. 2,7 typ. max. 3,0 3,3	20 50	0,9 ⁴	470			5,0	30
LD 53	70	red } min. 2,0 typ. max. 2,6	10 30	0,5 1,0	632	3,0	10	- 25 + 85	
		green } min. 1,9 typ. max. 2,4	20 30	0,25 0,5	558			- 25 - 25 + 85	
		yellow } min. 1,9 typ. max. 2,4	20 30	0,25 0,5	558			- 25 - 25 + 85	
Combination red / green									
LD 56	45	red } min. 2,1 typ. max. 3,0	10 20	2,2	700	5,0	100	- 40 + 85	
		green } min. 2,1 typ. max. 3,0	10 25	3,9	555			- 40 + 85	
		yellow } min. 2,1 typ. max. 3,0	10 25	3,9	555			- 40 + 85	
Combination red / green									
LD 96 flashing	200	min. typ. max.		0,5 ² 1,6 ²	660	0,4		- 40 + 70	

¹ with typical forward current
² at V_S = 5 V

³ Water proofing at 30 minutes at 1 m water column = IP 67.
⁴ at I_F = 20 mA

Models:

Light colour

Housing

Dimensions

LD 30	
LD 40	brass
LD 60	chromium-plated
LD 70	
LD 30 S	
LD 40 S	brass
LD 60 S	black, matt finish
LD 70 S	

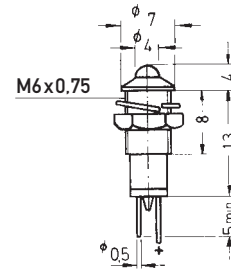

Also available with integrated resistor for 24 V operation.
Additional to type number: – 24

LD 32	
LD 42	brass
LD 62	chromium-plated
LD 72	
LD 32 S	
LD 42 S	brass
LD 62 S	black, matt finish
LD 72 S	

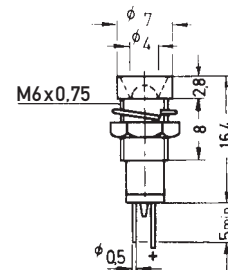

Also available with integrated resistor for 24 V operation.
Additional to type number: – 24

LD 34	
LD 44	brass
LD 64	chromium-plated
LD 34 S	
LD 44 S	brass
LD 64 S	black, matt finish

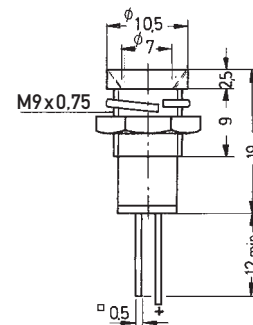

LD 36	brass	superbright
LD 46	chromium-plated	
LD 66		
LD 36 S	brass	superbright
LD 46 S	black, matt finish	
LD 66 S		

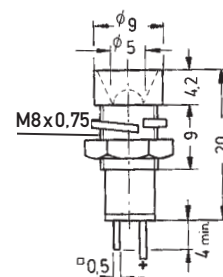

Also available with integrated resistor for 24 V operation.
Additional to type number: – 24



LED-Indicators

Models:

Light colour Housing Dimensions

LD 53

brass
chromium-plated

tricoloured

Connection diagram:

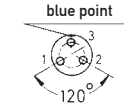

1 = anode green
2 = anode red
3 = common cathode

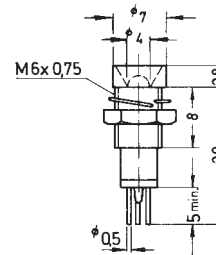

LD 53 S

brass
black, matt finish

tricoloured

LD 56

brass
chromium-plated

tricoloured

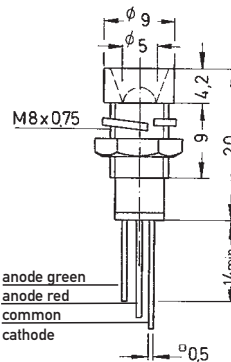

LD 56 S

brass
black, matt finish

tricoloured

LD 96 R

brass
chromium-plated

flashing

LD 96 G

LD 96 Y

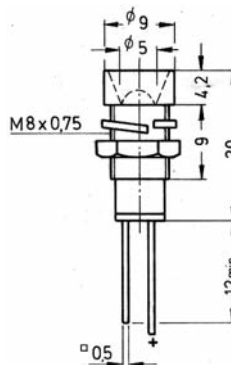

LD 96 SR

brass
black, matt finish

flashing

LD 96 SG

LD 96 SY

Flashing frequency = 3 Hz

Supply voltage = 4,75 V – 7 V

LDE 36

brass
chromium-plated

waterproof

LDE 46

LDE 66

brass
black, matt finish

waterproof

LDE 36 S

LDE 46 S

LDE 66 S

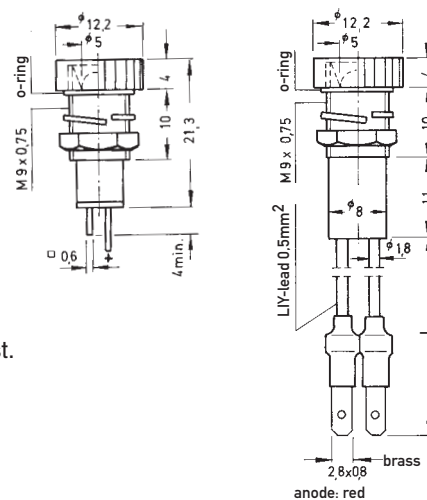

Special version: with lead and connector

Additional to type number: W

L = 50 mm; other length: minimum quantity and delivery time on request.

Also available with integrated resistor for 24 V operation.

Additional to type number: – 24

X-ON Electronics

Largest Supplier of Electrical and Electronic Components

Click to view similar products for [Standard LEDs - Through Hole category:](#)

Click to view products by [Knitter-Switch manufacturer:](#)

Other Similar products are found below :

[LTL-10254W](#) [LTL-1214A](#) [LTL-1BEDJ](#) [LTL-2231AT](#) [LTL-3251A](#) [LTL-4262N](#) [LTL-5234](#) [LTL87HTBK](#) [LTL-87HD4B](#) [7383/V7C3-BSTA-L/PR3/MS](#) [G22041431007J2C000](#) [HLMP-AG64-X10ZZ](#) [HLMP-EG1A-Z10DV](#) [HLMP-EL3B-WXKDD](#) [HLMP-HB74-UVBDD](#) [HLMP-HG65-VY0DD](#) [HLMP-HM74-34CDD](#) [HLMP-HM75-34CDD](#) [1L0532V23G0TD001](#) [NSPW500CS](#) [C4SMA-BGF-CQ34Q3C2](#) [L53GC13](#) [264-7SURTS530-A3](#) [L-C150JRCT](#) [S4SMS-BJF-CQ42QGF2](#) [S4SMS-GJF-CW12QMF2](#) [LD CQDP-1U3U-W5-1-K](#) [LNX998CKBDA](#) [LO566UHR3-70G-A3](#) [SLA560WBD2PT3](#) [LP379PPG1C0G0300001](#) [SLR-322MCT32](#) [SLR-342DUT32](#) [SLR-342MC3F](#) [SLR343BC7TT32](#) [SLR343BCTT32](#) [SLX-LX3044GD](#) [SLX-LX3044ID](#) [SLX-LX3044YD](#) [SNW-LX504SRC/4](#) [1.90690.3330000](#) [SSL-LX20483ID](#) [SSL-LX3034YD](#) [SSL-LX5093LGT-11](#) [SSL-LX5093PGC](#) [SSL-LX5093SRC/F](#) [SSL-LX5093SYT](#) [SSL-LX5099SRSGC-CA](#) [SSL-LX509E3SIT](#) [SSL-LX509FT3ID](#)