



- Home
- About KSS
- Contact Us
- What's New
- New Product
- Our Products
- Search

0710 KSS Snap Bushing



- Material: UL approved Nylon 66, 94V-2
- Color: Black
- KSS SNAP BUSHING smooth and insulate your raw-edged holes in metal chassis.
- Locking into hole firmly with fingertip pressure.
- Protect electrical cables, ropes, utility lines through metal holes.
- Available in application for chassis thickness Under 3.2mm

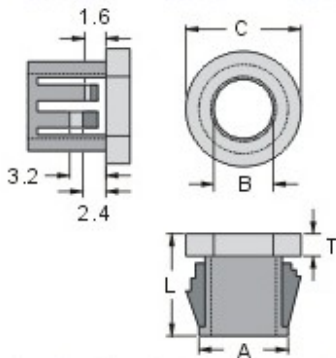

Standard Design

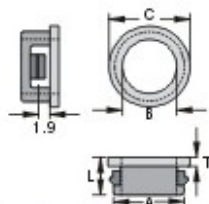

SB-7S, 8S, 12S, 22S

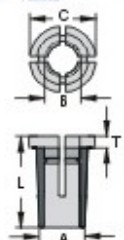

































SBP-8

※ SB-8A: available for chassis thickness under 2.2 mm

※ SB-8: available for chassis thickness under 1.6 mm

Unit: mm

| | Item No. | Mounting Hole A | B | C | L | T | Packing |
|---|---|-----------------|------|------|------|-----|---------------|
| | □ SB-7S | 7.1 | 5.8 | 8.8 | 6.1 | 1.3 | 100 pcs / Bag |
|  | □ SB-8S | 7.9 | 6.8 | 9.8 | 6.0 | 1.5 | |
|  | □ SB-12S | 11.9 | 9.2 | 13.7 | 6.3 | 1.5 | |
|  | □ SB-22S | 22.2 | 19.6 | 24.0 | 6.5 | 1.5 | |
|  | ※  □ SB-8A | 7.9 | 5.1 | 10.5 | 8.0 | 1.6 | |
|  | ※  □ SB-8 | 7.9 | 5.8 | 10.5 | 8.0 | 1.6 | |
| | □ SBP-8 | 7.4 | 5.9 | 10.8 | 15.0 | 2.0 | |
|  |  □ SB-10 | 9.5 | 6.4 | 12.0 | 10.3 | 1.6 | |
|  |  □ SB-10M | 9.5 | 7.8 | 13.0 | 10.5 | 1.6 | |
|  |  □ SB-13 | 12.7 | 8.0 | 15.0 | 10.3 | 1.6 | |
|  |  □ SB-14 | 14.3 | 11.4 | 17.0 | 10.3 | 1.5 | |
|  |  □ SB-16 | 15.9 | 12.7 | 18.6 | 10.3 | 1.6 | |
|  |  □ SB-19 | 19.1 | 14.3 | 21.7 | 10.3 | 1.6 | |
|  |  □ SB-19M | 19.1 | 15.8 | 21.7 | 10.3 | 1.6 | |
| | □ SB-20 | 20.0 | 15.9 | 22.4 | 10.0 | 1.4 | |
|  |  □ SB-22 | 22.2 | 17.5 | 24.2 | 11.5 | 1.6 | |
|  |  □ SB-22M | 22.2 | 18.9 | 24.2 | 11.5 | 1.6 | |
| | □ SB-25 | 25.4 | 19.5 | 28.5 | 11.7 | 1.8 | |
|  |  □ SB-26 | 25.8 | 19.1 | 28.5 | 11.5 | 1.6 | |
|  |  □ SB-30 | 30.1 | 24.1 | 33.3 | 11.5 | 1.6 | |
| | □ SB-32 | 32.0 | 23.8 | 34.6 | 11.4 | 1.5 | |
|  |  □ SB-38 | 38.1 | 29.0 | 42.1 | 11.4 | 1.5 | |
|  |  □ SB-45 | 44.5 | 35.4 | 47.8 | 11.6 | 1.5 | |
|  |  □ SB-50 | 50.8 | 41.6 | 54.6 | 11.8 | 1.6 | |

X-ON Electronics

Largest Supplier of Electrical and Electronic Components

Click to view similar products for [Grommets & Bushings](#) category:

Click to view products by [KSS](#) manufacturer:

Other Similar products are found below :

[M10-036565-101](#) [M10-036565-143](#) [M10-036565-183](#) [M10-036565-244](#) [M10-036565-122](#) [M10-036565-163](#) [M10-036565-232](#) [HSS-M32-TPE-V0](#) [NSYTS AKFL](#) [SP-16 TPE](#) [SP-20 TPE](#) [SK 8-13 TPE](#) [4014B](#) [2407](#) [ALBCBS36025](#) [2141-P](#) [HTL-40-10-TPE](#) [634430090](#) [2417-P](#) [2917-P](#) [3108-P](#) [2871-P](#) [1342664](#) [100187](#) [100188](#) [100216](#) [100223](#) [100236](#) [52001970](#) [52001980](#) [52002010](#) [52002020](#) [52002050](#) [VG-1](#) [FEM 27-35](#) [100175](#) [100176](#) [100178](#) [100182](#) [100196](#) [100238](#) [100244](#) [100744](#) [100084](#) [100174](#) [100177](#) [100179](#) [100180](#) [100181](#) [100186](#)