

## 2 Form A Solid-State Relay

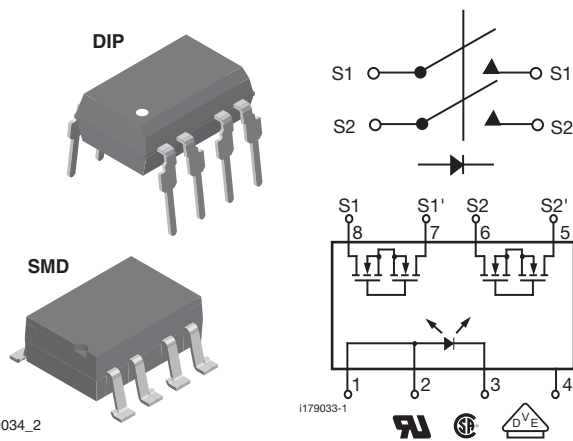

### FEATURES

- Current limit protection
- Isolation test voltage 5300 V<sub>RMS</sub>
- Typical R<sub>ON</sub> 10 Ω
- Load voltage 200 V
- Load current 140 mA
- High surge capability
- Clean bounce free switching
- Low power consumption
- High reliability monolithic output die
- SMD lead available on tape and reel
- Compliant to RoHS Directive 2002/95/EC and in accordance to WEEE 2002/96/EC

**RoHS**  
COMPLIANT

### DESCRIPTION

The LH1513 relays are DPST normally open switches (2 form A) that can replace electromechanical relays in many applications. The relays are constructed using a GaAlAs LED for actuation control and an integrated monolithic die for the switch output. The die, fabricated in a high-voltage dielectrically isolated technology, is comprised of a photodiode array, switch control circuitry, and DMOS switches. In addition, these relays employ current-limiting circuitry, enabling them to pass lightning surge testing as per ANSI/TIA-968-B and other regulatory voltage surge requirements when overvoltage protection is provided.

### APPLICATIONS

- General telecom switching
  - On/off hook control
  - Ring delay
  - Dial pulse
  - Ground start
  - Ground fault protection
- Instrumentation
- Industrial controls

### AGENCY APPROVALS

UL1577: file no. E52744 system code H, double protection  
 CSA: certification no. 093751  
 DIN EN: 60747-5-2 (VDE 0884)/60747-5-5 (pending), available with option 1

### ORDERING INFORMATION

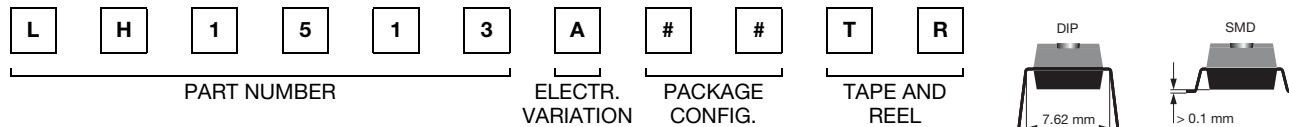

PACKAGE	UL, CSA
SMD-8, tubes	LH1513AAC
SMD-8, tape and reel	LH1513AACTR
DIP-8, tubes	LH1513AB

### ABSOLUTE MAXIMUM RATINGS (T<sub>amb</sub> = 25 °C, unless otherwise specified)

PARAMETER	TEST CONDITION	SYMBOL	VALUE	UNIT
<b>INPUT</b>				
LED continuous forward current		I <sub>F</sub>	50	mA
LED reverse voltage	I <sub>R</sub> ≤ 10 μA	V <sub>R</sub>	8	V



<b>ABSOLUTE MAXIMUM RATINGS</b> ( $T_{amb} = 25\text{ }^{\circ}\text{C}$ , unless otherwise specified)				
PARAMETER	TEST CONDITION	SYMBOL	VALUE	UNIT
<b>OUTPUT</b>				
DC or peak AC load voltage	$I_L \leq 50\text{ }\mu\text{A}$	$V_L$	200	V
Continuous DC load current, one pole operating		$I_L$	200	mA
Continuous DC load current two poles operating		$I_L$	140	mA
Peak load current (single shot)	$t = 100\text{ ms}$	$I_P$	(1)	
<b>SSR</b>				
Ambient temperature range		$T_{amb}$	- 40 to + 85	$^{\circ}\text{C}$
Storage temperature range		$T_{stg}$	- 40 to + 150	$^{\circ}\text{C}$
Pin soldering temperature (2)	$t = 10\text{ s max.}$	$T_{sld}$	260	$^{\circ}\text{C}$
Input to output isolation voltage		$V_{ISO}$	5300	$V_{RMS}$
Pole-to-pole isolation voltage (S1 to S2)			500	V
Output power dissipation (continuous)		$P_{diss}$	600	mW

**Notes**

- Stresses in excess of the absolute maximum ratings can cause permanent damage to the device. Functional operation of the device is not implied at these or any other conditions in excess of those given in the operational sections of this document. Exposure to absolute maximum ratings for extended periods of the time can adversely affect reliability.
- (1) Refer to current limit performance application note for a discussion on relay operation during transient currents.
- (2) Refer to reflow profile for soldering conditions for surface mounted devices (SMD). Refer to wave profile for soldering conditions for through hole devices (DIP).

<b>ELECTRICAL CHARACTERISTICS</b> ( $T_{amb} = 25\text{ }^{\circ}\text{C}$ , unless otherwise specified)						
PARAMETER	TEST CONDITION	SYMBOL	MIN.	TYP.	MAX.	UNIT
<b>INPUT</b>						
LED forward current, switch turn-on	$I_L = 100\text{ mA}$ , $t = 10\text{ ms}$	$I_{Fon}$		2	3	mA
LED forward current, switch turn-off	$V_L = \pm 150\text{ V}$	$I_{Foff}$	0.2	0.8		mA
LED forward voltage	$I_F = 10\text{ mA}$	$V_F$	1.15	1.26	1.45	V
<b>OUTPUT</b>						
On-resistance	$I_F = 5\text{ mA}$ , $I_L = 50\text{ mA}$	$R_{ON}$	6	10	15	$\Omega$
Pole-to-pole on-resistance matching (S1 to S2)	$I_F = 5\text{ mA}$ , $I_L = 50\text{ mA}$			0.1	1	$\Delta\Omega$
Off-resistance	$I_F = 0\text{ mA}$ , $V_L = \pm 100\text{ V}$	$R_{OFF}$	0.5	5000		$G\Omega$
Current limit	$I_F = 5\text{ mA}$ , $t = 5\text{ ms}$ , $V_L = \pm 5\text{ V}$	$I_{LMT}$	300	360	460	mA
Off-state leakage current	$I_F = 0\text{ mA}$ , $V_L = \pm 100\text{ V}$	$I_O$		0.02	200	nA
	$I_F = 0\text{ mA}$ , $V_L = \pm 200\text{ V}$	$I_O$			1	$\mu\text{A}$
Output capacitance	$I_F = 0\text{ mA}$ , $V_L = 1\text{ V}$	$C_O$		60		pF
	$I_F = 0\text{ mA}$ , $V_L = 50\text{ V}$	$C_O$		15		pF
Pole-to-pole capacitance (S1 to S2)	$I_F = 0\text{ mA}$			3		pF
	$I_F = 5\text{ mA}$			4		pF
Switch offset	$I_F = 5\text{ mA}$	$V_{OS}$		0.15		$\mu\text{V}$
<b>TRANSFER</b>						
Capacitance (input to output)	$V_{ISO} = 1\text{ V}$	$C_{IO}$		1.1		pF

**Note**

- Minimum and maximum values are testing requirements. Typical values are characteristics of the device and are the result of engineering evaluations. Typical values are for information only and are not part of the testing requirements.

<b>SWITCHING CHARACTERISTICS</b> ( $T_{amb} = 25\text{ }^{\circ}\text{C}$ , unless otherwise specified)						
PARAMETER	TEST CONDITION	SYMBOL	MIN.	TYP.	MAX.	UNIT
Turn-on time (NO)	$I_F = 10\text{ mA}$ , $I_L = 50\text{ mA}$	$t_{on}$		1.6	2.5	ms
Turn-off time (NO)	$I_F = 10\text{ mA}$ , $I_L = 50\text{ mA}$	$t_{off}$		0.65	2.5	ms



## TYPICAL CHARACTERISTICS (T<sub>amb</sub> = 25 °C, unless otherwise specified)

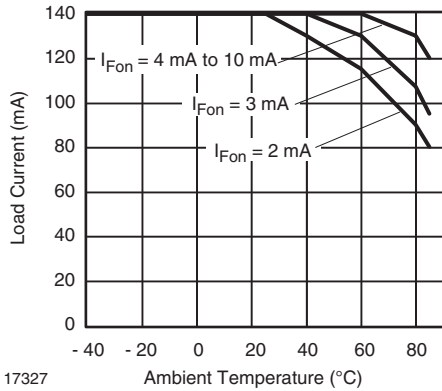

Fig. 1 - Recommended Operating Conditions

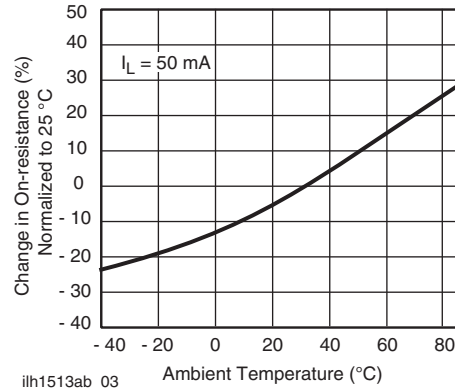

Fig. 4 - On-Resistance vs. Temperature

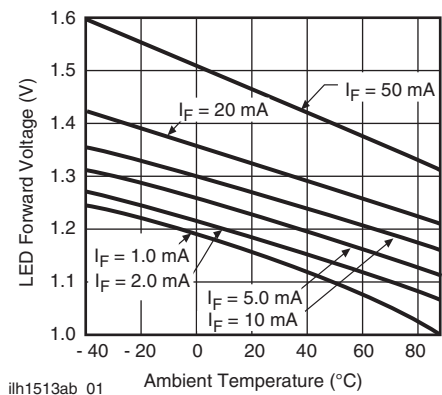

Fig. 2 - LED Voltage vs. Temperature

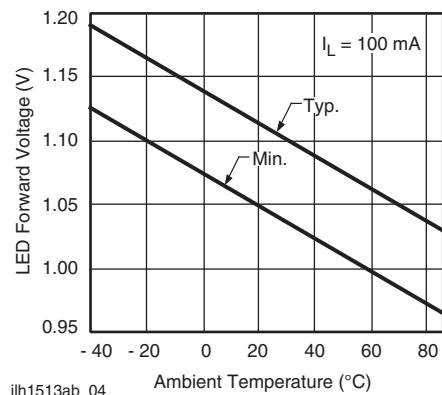

Fig. 5 - LED Dropout Voltage vs. Temperature

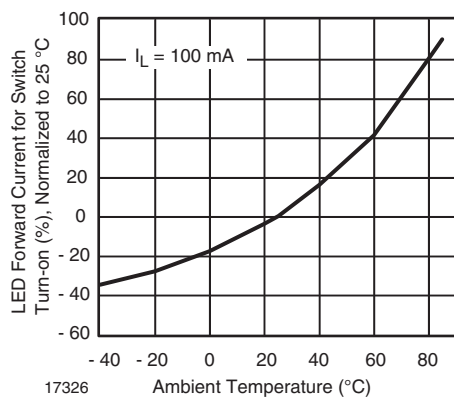

Fig. 3 - LED Current for Switch Turn-on vs. Temperature

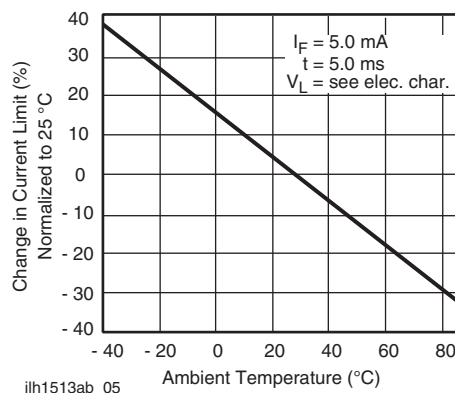
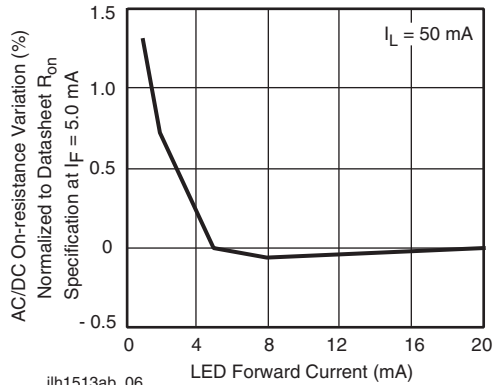
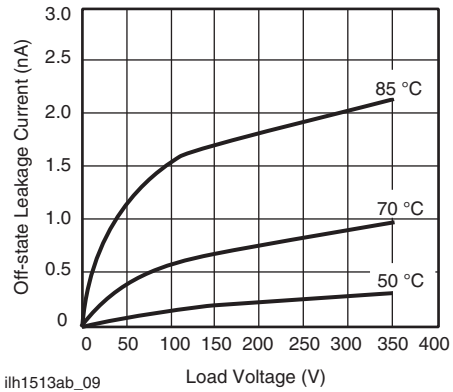

Fig. 6 - Current Limit vs. Temperature



ilh1513ab\_06

Fig. 7 - Variation in On-Resistance vs. LED Current



ilh1513ab\_09

Fig. 10 - Leakage Current vs. Applied Voltage at Elevated Temperatures

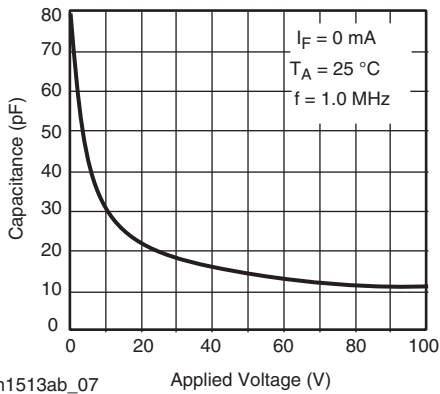

ilh1513ab\_07

Fig. 8 - Switch Capacitance vs. Applied Voltage

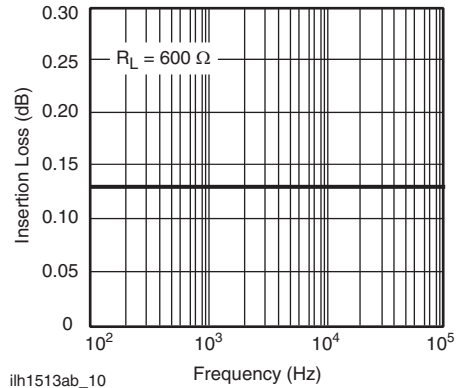

ilh1513ab\_10

Fig. 11 - Insertion Loss vs. Frequency

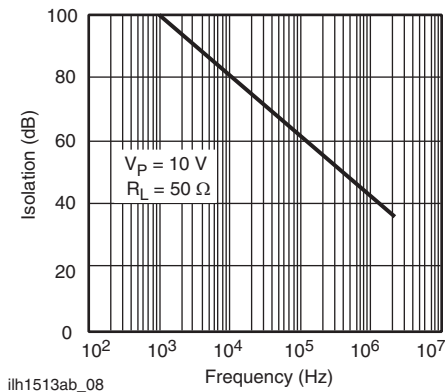

ilh1513ab\_08

Fig. 9 - Output Isolation

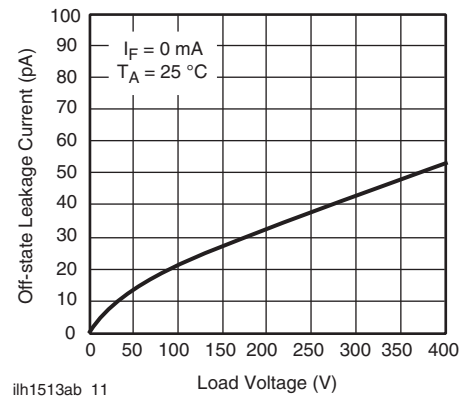

ilh1513ab\_11

Fig. 12 - Leakage Current vs. Applied Voltage

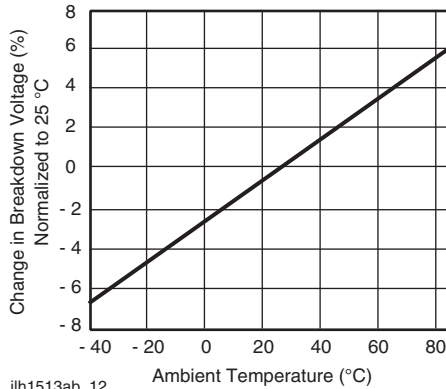

ilh1513ab\_12

Fig. 13 - Switch Breakdown Voltage vs. Temperature

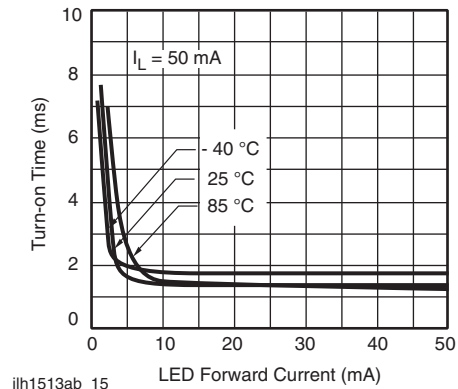

ilh1513ab\_15

Fig. 16 - Turn-on Time vs. LED Current

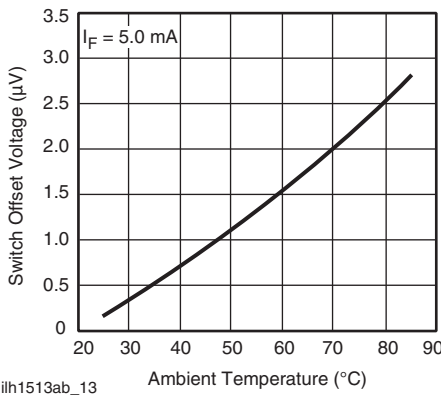

ilh1513ab\_13

Fig. 14 - Switch Offset Voltage vs. Temperature

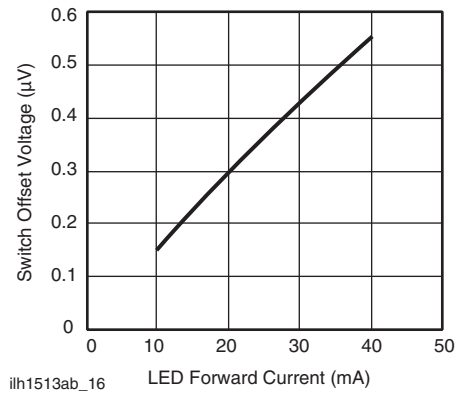

ilh1513ab\_16

Fig. 17 - Switch Offset Voltage vs. LED Current

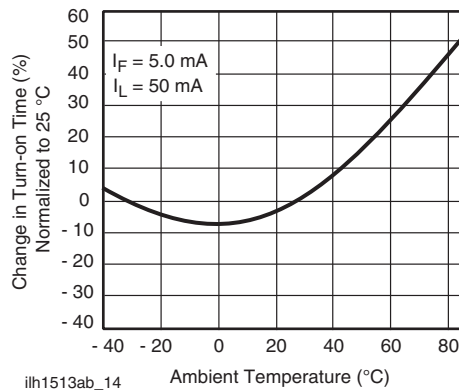

ilh1513ab\_14

Fig. 15 - Turn-on Time vs. Temperature

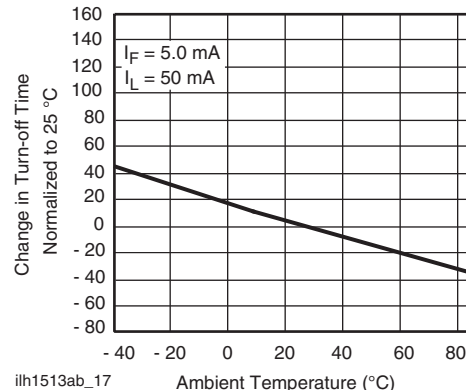

ilh1513ab\_17

Fig. 18 - Turn-off Time vs. Temperature

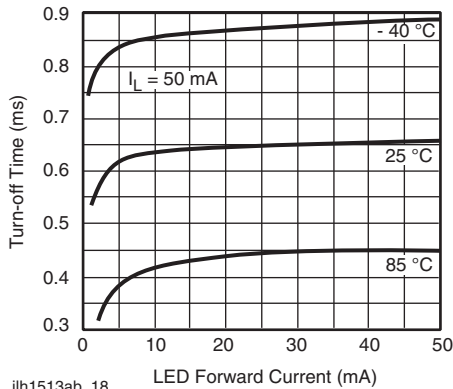

ilh1513ab\_18

Fig. 19 - Turn-off Time vs. LED Current

## PACKAGE DIMENSIONS in millimeters

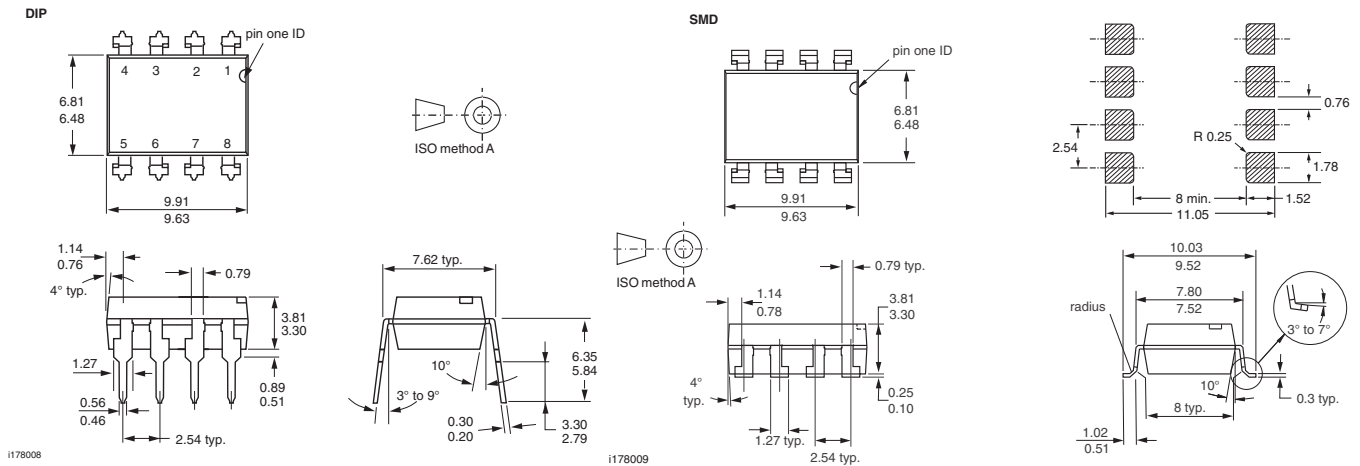

## PACKAGE MARKING (example)

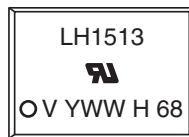

### Note

- Tape and reel suffix (TR) is not part of the package marking.



## **Disclaimer**

ALL PRODUCT, PRODUCT SPECIFICATIONS AND DATA ARE SUBJECT TO CHANGE WITHOUT NOTICE TO IMPROVE RELIABILITY, FUNCTION OR DESIGN OR OTHERWISE.

Vishay Intertechnology, Inc., its affiliates, agents, and employees, and all persons acting on its or their behalf (collectively, "Vishay"), disclaim any and all liability for any errors, inaccuracies or incompleteness contained in any datasheet or in any other disclosure relating to any product.

Vishay makes no warranty, representation or guarantee regarding the suitability of the products for any particular purpose or the continuing production of any product. To the maximum extent permitted by applicable law, Vishay disclaims (i) any and all liability arising out of the application or use of any product, (ii) any and all liability, including without limitation special, consequential or incidental damages, and (iii) any and all implied warranties, including warranties of fitness for particular purpose, non-infringement and merchantability.

Statements regarding the suitability of products for certain types of applications are based on Vishay's knowledge of typical requirements that are often placed on Vishay products in generic applications. Such statements are not binding statements about the suitability of products for a particular application. It is the customer's responsibility to validate that a particular product with the properties described in the product specification is suitable for use in a particular application. Parameters provided in datasheets and / or specifications may vary in different applications and performance may vary over time. All operating parameters, including typical parameters, must be validated for each customer application by the customer's technical experts. Product specifications do not expand or otherwise modify Vishay's terms and conditions of purchase, including but not limited to the warranty expressed therein.

Except as expressly indicated in writing, Vishay products are not designed for use in medical, life-saving, or life-sustaining applications or for any other application in which the failure of the Vishay product could result in personal injury or death. Customers using or selling Vishay products not expressly indicated for use in such applications do so at their own risk. Please contact authorized Vishay personnel to obtain written terms and conditions regarding products designed for such applications.

No license, express or implied, by estoppel or otherwise, to any intellectual property rights is granted by this document or by any conduct of Vishay. Product names and markings noted herein may be trademarks of their respective owners.

## X-ON Electronics

Largest Supplier of Electrical and Electronic Components

*Click to view similar products for [Solid State Relays - PCB Mount](#) category:*

*Click to view products by [Vishay](#) manufacturer:*

Other Similar products are found below :

[M90F-2W](#) [G2-1A07-ST](#) [G2-1A07-TT](#) [G2-1B02-TT](#) [G2-DA06-ST](#) [G3CN-202PL-3-US DC12](#) [G3CN-203P DC3-28](#) [G3RDX02SNUSDC12](#)  
[PLA134S](#) [DMP6202A](#) [DS11-1005](#) [AQ3A2-ZT432VDC](#) [AQV212J](#) [AQV214SD02](#) [AQV252GAJ](#) [AQY212SXT](#) [AQY221R2SJ](#)  
[EFR1200480A150](#) [LCA220](#) [LCB110S](#) [1618400-5](#) [SR75-1ST](#) [AQV212AJ](#) [AQV238AD01](#) [AQV252GAXJ](#) [AQW414TS](#) [AQY210SXT](#)  
[AQY212ST](#) [AQY221N2V1YJ](#) [AQY275AXJ](#) [G2-1A02-ST](#) [G2-1A02-TT](#) [G2-1A03-ST](#) [G2-1A03-TT](#) [G2-1A05-ST](#) [G2-1A06-TT](#) [G2-1A23-](#)  
[TT](#) [G2-1B01-ST](#) [G2-1B01-TT](#) [G2-1B02-ST](#) [G2-DA03-ST](#) [G2-DA03-TT](#) [G2-DA06-TT](#) [G3M-203PL-UTU-1 DC24](#) [CPC2330N](#) [3-1617776-](#)  
[2](#) [CTA2425](#) [TS190](#) [LBB110S](#) [LCB126S](#)