

5mm Round With Flange Type  
Infrared LED  
Technical Data Sheet

Part No.: 503HIRT2V-1CD



## Features:

- Standard T-1 3/4 diameter package.
- Low forward voltage.
- Infrared Emitting Diode.
- Viewing angle =30°.
- Reliable and rugged.
- The product itself will remain within RoHS complaint Version.

## Descriptions:

The device is spectrally matched with silicon photodiode and phototransistor.

## Applications:

- Floppy disk drive.
- Optoelectronic switch.
- Camera.
- VCR.
- Video.
- Smoke detector.
- Infrared applied system.
- Free air transmission system.
- Infrared remote control units.

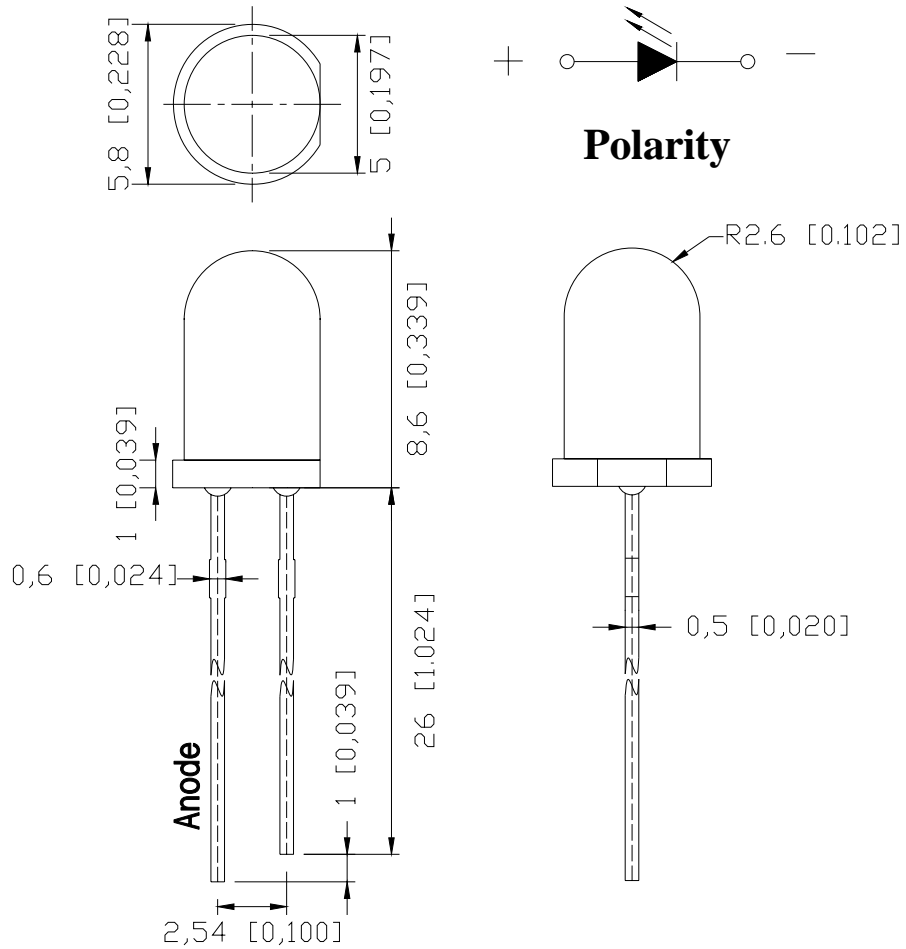
**Package Dimension:**

| Part No.      | Material | Lens Color       | Source Color |
|---------------|----------|------------------|--------------|
| 503HIRT2V-1CD | GaAlAs   | Blue Transparent | Infrared     |

**Notes:**

1. All dimensions are in millimeters (inches).
2. Tolerance is  $\pm 0.25$  (.010" ) unless otherwise specified.
3. Protruded resin under flange is 1.00mm (.039" ) max.
4. Specifications are subject to change without notice.

**Absolute Maximum Ratings at Ta=25**

| Parameters   | Symbol | Max.              | Unit |
|--|--------|-------------------|------|
| Power Dissipation  | PD     | 160               | mW   |
| Peak Forward Current<br>(1/10 Duty Cycle, 0.1ms Pulse Width) | IFP    | 1                 | A    |
| Forward Current  | IF     | 100               | mA   |
| Reverse Voltage  | VR     | 5                 | V    |
| Operating Temperature Range                                  | Topr   | -40 to +85        |      |
| Storage Temperature Range                                    | Tstg   | -40 to +100       |      |
| Soldering Temperature  | Tsld   | 260 for 5 Seconds |      |

**Electrical Optical Characteristics at Ta=25**

| Parameters               | Symbol            | Min. | Typ. | Max. | Unit  | Test Condition    |
|--------------------------|-------------------|------|------|------|-------|-------------------|
| Radiant Intensity        | Ee                | 6.5  | 13.0 | ---  | mW/sr | IF =20mA (Note 1) |
| Viewing Angle*           | 2θ <sub>1/2</sub> | ---  | 30   | ---  | Deg   | IF =20mA (Note 2) |
| Peak Emission Wavelength | λ <sub>p</sub>    | ---  | 880  | ---  | nm    | IF=20mA           |
| Spectral Bandwidth       | λ                 | ---  | 45   | ---  | nm    | IF=20mA           |
| Forward Voltage          | VF                | 1.00 | 1.30 | 1.60 | V     | IF =20mA          |
| Reverse Current          | IR                | ---  | ---  | 10   | μA    | VR=5V             |

**Notes:**

1. Radiant Intensity Measurement allowance is  $\pm 10\%$ .
2.  $\theta_{1/2}$  is the off-axis angle at which the luminous intensity is half the axial luminous intensity.

Typical Electrical / Optical Characteristics Curves  
(25 Ambient Temperature Unless Otherwise Noted)

Fig.1 Forward Current vs. Ambient Temperature

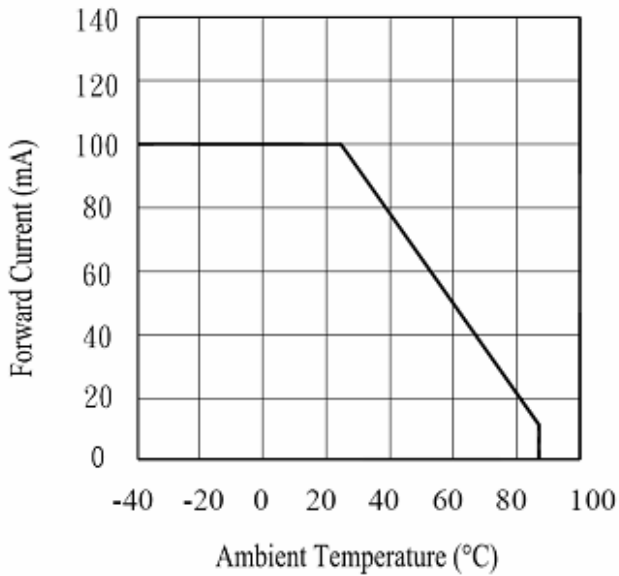

Fig.2 Spectral Distribution

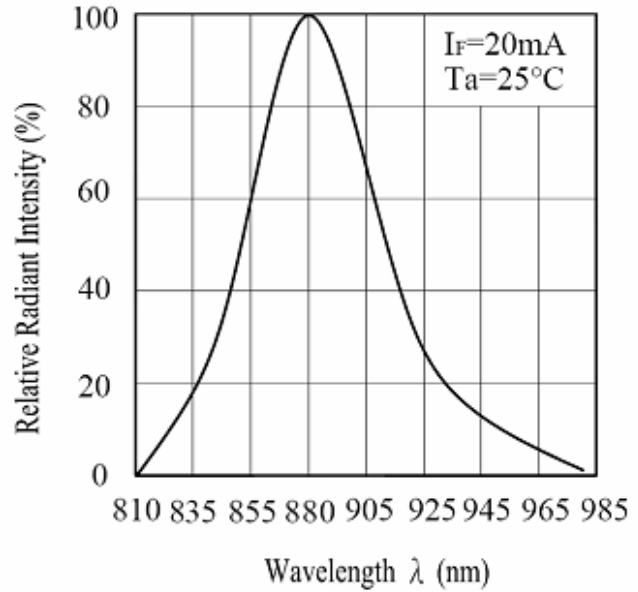

Fig.3 Peak Emission Wavelength vs. Ambient Temperature

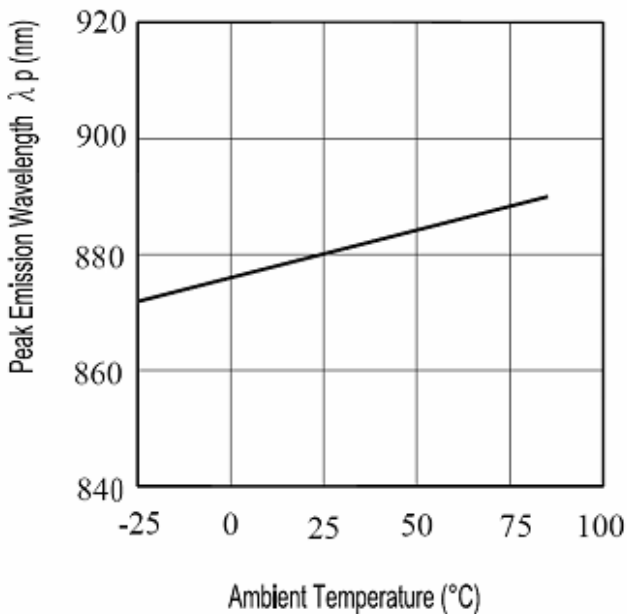
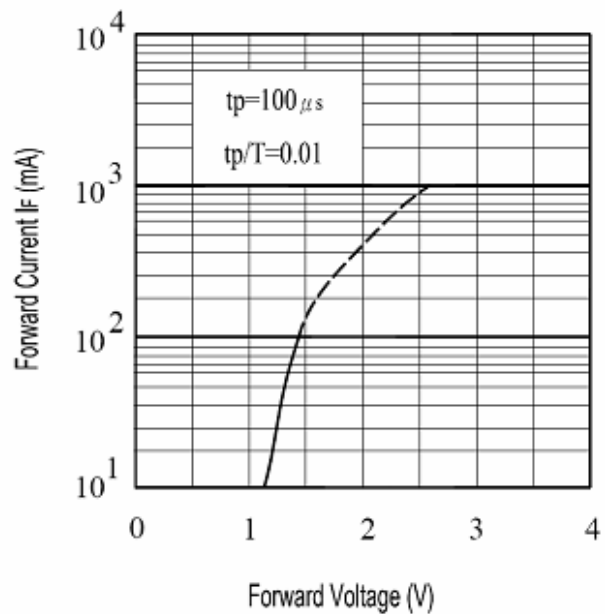

Fig.4 Forward Current vs. Forward Voltage



Relative Intensity & Forward Current

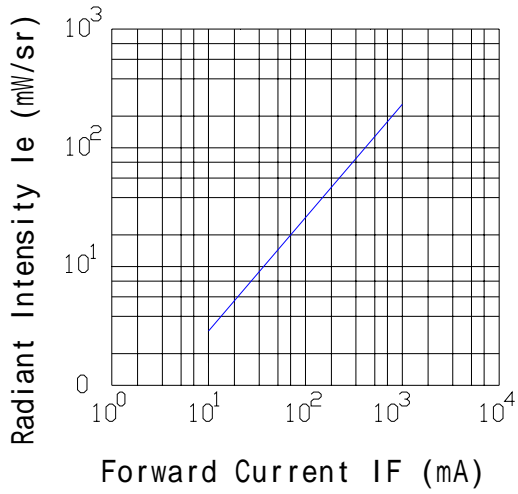

Fig.7 Relative Intensity vs. Ambient Temperature ( )

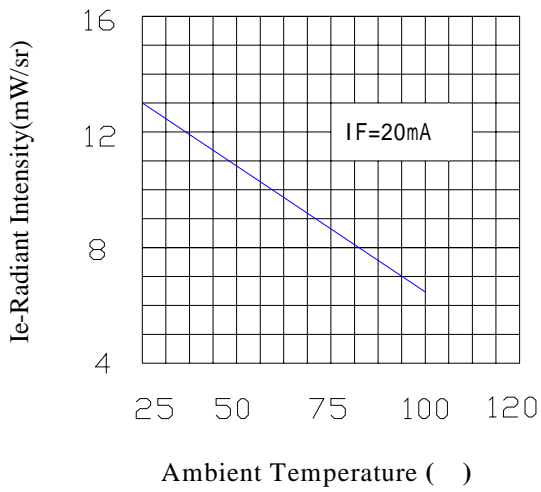

Fig.6 Relative Radiant Intensity vs. Angular Displacement

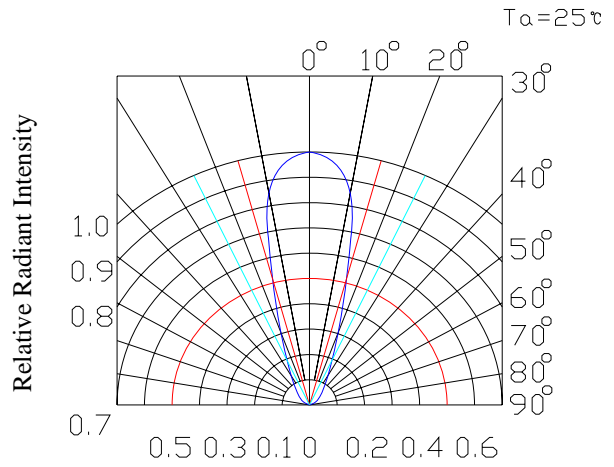
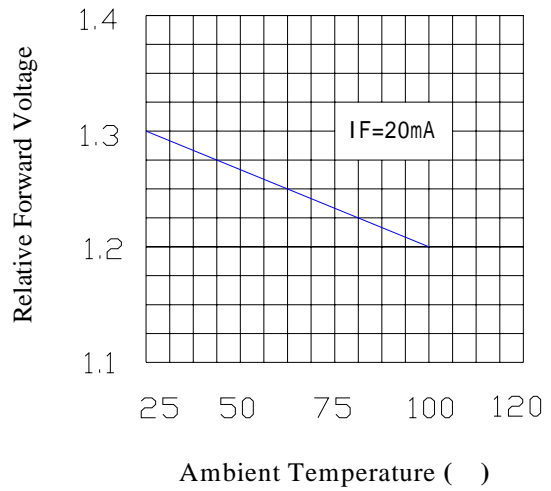

Fig.8 Forward Voltage vs. Ambient Temperature ( )



### Reliability Test Items And Conditions:

The reliability of products shall be satisfied with items listed below:

Confidence level: 90%.

LTPD: 10%.

#### 1) Test Items and Results:

| No. | Item                                  | Test Conditions                                     | Test Hours/<br>Cycles | Sample<br>Sizes | Failure<br>Judgment<br>Criteria   | Ac/<br>Re |
|-----|---------------------------------------|---|-----------------------|-----------------|---|-----------|
| 1   | Reflow Soldering                      | TEMP.: 260 $\pm$ 5<br>5secs                         | 6mins                 | 22pcs           | IR U $\times$ 2<br>Ee L $\times$ 0.8<br>VF U $\times$ 1.2<br><br>U: Upper<br>Specification<br>Limit<br>L: Lower<br>Specification<br>Limit | 0/1       |
| 2   | Temperature<br>Cycle                  | H: +100 15mins<br>┌<br>5 mins<br>└<br>L: -40 15mins | 50Cycles              | 22pcs           |   | 0/1       |
| 3   | Thermal Shock                         | H: +100 15mins<br>┌<br>10secs<br>└<br>L: -10 5mins  | 50Cycles              | 22pcs           |   | 0/1       |
| 4   | High Temperature<br>Storage           | TEMP.: +100   | 1000hrs               | 22pcs           |   | 0/1       |
| 5   | Lower<br>Temperature<br>Storage       | TEMP.: -40  | 1000hrs               | 22pcs           |   | 0/1       |
| 6   | DC Operating Life                     | V <sub>CE</sub> =5V                                 | 1000hrs               | 22pcs           |   | 0/1       |
| 7   | High<br>Temperature/<br>High Humidity | 85 / 85% R.H  | 1000hrs               | 22pcs           |   | 0/1       |

Please read the following notes before using the product:

1. Over-current-proof

Customer must apply resistors for protection, otherwise slight voltage shift will cause big current change (Burn out will happen).

2. Storage

- 2.1 Do not open moisture proof bag before the products are ready to use.
- 2.2 Before opening the package, the LEDs should be kept at 30 °C or less and 80%RH or less.
- 2.3 The LEDs should be used within a year.
- 2.4 After opening the package, the LEDs should be kept at 30 °C or less and 60%RH or less.
- 2.5 The LEDs should be used within 168 hours (7 days) after opening the package.

3. Soldering Iron

Each terminal is to go to the tip of soldering iron temperature less than 260 °C for 5 seconds within once in less than the soldering iron capacity 25W. Leave two seconds and more intervals, and do soldering of each terminal. Be careful because the damage of the product is often started at the time of the hand solder.

4. Soldering

When soldering, for Lamp without stopper type and must be leave a minimum of 3mm clearance from the base of the lens to the soldering point.  
 To avoided the Epoxy climb up on lead frame and was impact to non-soldering problem, dipping the lens into the solder must be avoided.  
 Do not apply any external stress to the lead frame during soldering while the LED is at high temperature.

Recommended soldering conditions:

| Soldering Iron |                                | Wave Soldering |              |
|----------------|--------------------------------|----------------|--------------|
| Temperature    | 300 Max.                       | Pre-heat       | 100 Max.     |
| Soldering Time | 3 sec. Max.<br>(one time only) | Pre-heat Time  | 60 sec. Max. |
|                |                                | Solder Wave    | 260 Max.     |
|                |                                | Soldering Time | 5 sec. Max.  |

Note: Excessive soldering temperature and / or time might result in deformation of the LED lens or catastrophic failure of the LED.

5. Repairing

Repair should not be done after the LEDs have been soldered. When repairing is unavoidable, a double-head soldering iron should be used. It should be confirmed beforehand whether the characteristics of the LEDs will or will not be damaged by repairing.

6. Caution in ESD

Static Electricity and surge damages the LED. It is recommended to use a wrist band or anti-electrostatic glove when handling the LED. All devices equipment and machinery must be properly grounded.



## X-ON Electronics

Largest Supplier of Electrical and Electronic Components

*Click to view similar products for [Infrared Emitters - High Power](#) category:*

*Click to view products by [Lucky Light](#) manufacturer:*

Other Similar products are found below :

[IR19-315C/TR8](#) [SFH 4030](#) [SFH 4060](#) [HSM8-V380](#) [HSM9-V380](#) [SFH 5750](#) [PK2S-2KJE-A](#) [PK2S-2LJE-A](#) [PK2S-3KJE-A](#) [PK2S-3KKE-A](#)  
[PK2S-3LJE-A](#) [PK2S-4KJE-A](#) [AREQ-90C0-00000](#) [AREQ-80C0-00000](#) [SFH 4775S A01](#) [SST-10-IRD-B90H-S810](#) [SFH 4727A](#) [SFH 4726AS](#)  
[SFH 4717AS](#) [SFH 4725AS](#) [AREQ-8020-00000](#) [HR5P-N3FB-00000](#) [HR5P-N2FB-00000](#) [HR5P-N3CB-00000](#) [HR5P-N2CB-00000](#) [HR5P-](#)  
[N3CA-00000](#) [HR5P-N2CA-00000](#) [HR5P-N2FA-00000](#) [HR5P-N3FA-00000](#) [VSMY2853SLX01](#) [VSMY2853RGX01](#) [VSMY2853GX01](#)  
[VSMY2850GX01](#) [IN-P281ASGHIR](#) [IN-P281ASGIR](#) [QEE123](#) [HSDL-4400#011](#) [C3535SIR2C-2B](#) [KM-4457F3C](#) [L-53F3BT](#) [VTE1291W-2H](#)  
[LL-304IRC4B-2AD](#) [LL-503HIRT2E-1CC](#) [LL-503IRC2E-2AC](#) [LL-503IRC2V-2AD](#) [LL-503IRT2E-2AC](#) [LL-503IRT2E-2AE](#) [LL-](#)  
[503SIRC2E-1BD](#) [LL-503SIRC2H-1BE](#) [LL-S170IRC-2A](#)