

## ***3W Hi- Power LEDs Technical Data Sheet***

Model No:LL-HP60MXX1L-3W



## Features

- ◇ Very long operating life (up to 100k hours)
- ◇ Available in white, green, blue, red, yellow.
- ◇ More energy efficient than incandescent and most halogen lamps
- ◇ Low voltage DC operated
- ◇ Cool beam, safe to the touch
- ◇ Instant light (less than 100 ns)

## Applications

- ◇ Reading lights (car, bus, aircraft).
- ◇ Portable (flashlight, bicycle).
- ◇ Mini\_accent/Uplighters/  
Downlighters/Orientation
- ◇ Bollards/Security/Garden
- ◇ Cove/Undershelf/Task
- ◇ Automotive rear combination lamps.
- ◇ Traffic signaling/Beacons/ Rail crossing and Wayside
- ◇ Indoor/Outdoor Commercial and Residential Architectural
- ◇ Edge\_lit signs (Exit, point of sale)
- ◇ LCD Backlights/Light Guides.



### Emitter group

Emitter		White	Warm White	Red	Green
White Housing	Lambertion	LL-HP60MW1L-3W	LL-HP60MW61L-3W	LL-HP60MV1L-3W	LL-HP60MPG1L-3W
	Emitter	Blue	Yellow		
	Lambertion	LL-HP60MB1L-3W	LL-HP60MUY1L-3W		

### Lambertion Package Outlines

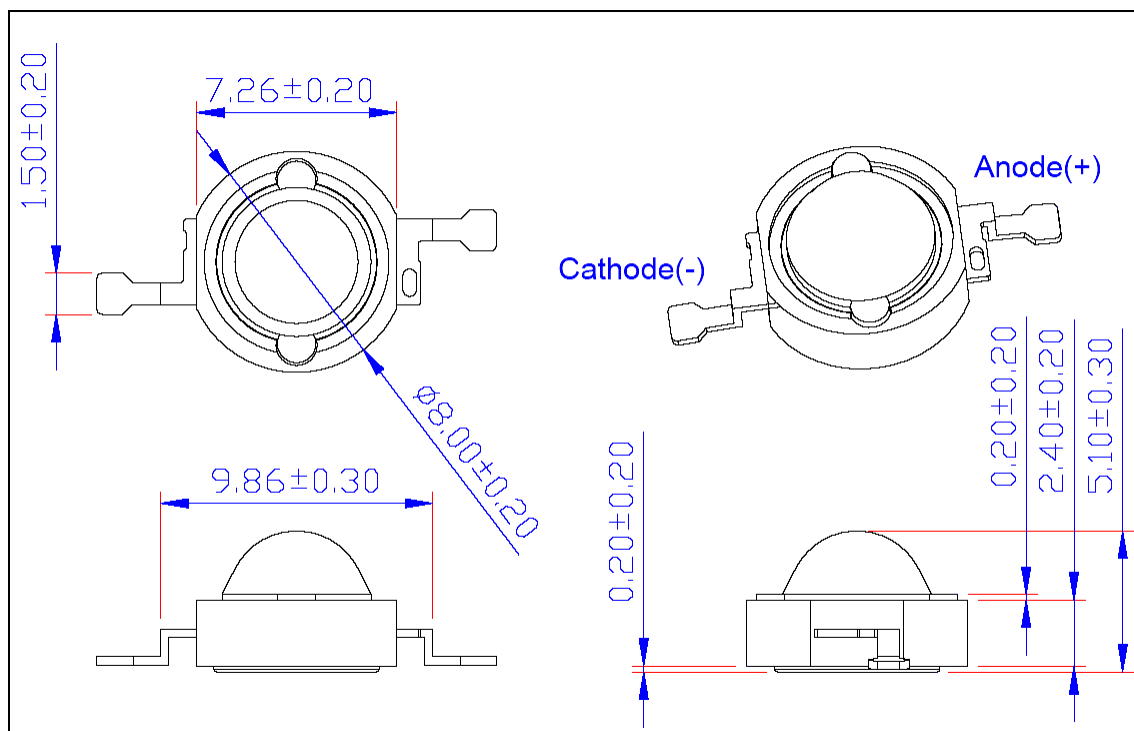

### Absolute Maximum Ratings at Ta=25°C

Parameter	Symbol	Rating	Units
Continuous Forward Current	IF	700	mA
Peak Pulse Current (tp ≤ 100 μs, Duty cycle=0.005) [1]	I pulse	1000	mA
Reverse Voltage	VR	5	V
LED Junction Temperature(at 350mA)	Tj	125	°C
Operating Temperature Range	Topr	-30 to +110	°C
Storage Temperature Range	Tstg	-30 to +120	°C
Soldering Temperature	Tsol	5	Seconds

Note:

[1] Duty cycle

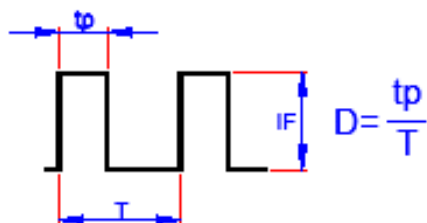

### Luminous Flux Characteristics at $I_F=700\text{mA}$ ( $T_a=25^\circ\text{C}$ )

Lens Item	Part No	Color	Flux			Units
			Min	Typ	Max	
Lambertian	LL-HP60MW1L-3W	White	51.2	70	---	lm
	LL-HP60MW61L-3W	Warm White	39.4	45	---	lm
	LL-HP60MB1L-3W	Blue	13.8	20	---	lm
	LL-HP60MPG1L-3W	True Green	51.2	65	---	lm
	LL-HP60MV1L-3W	Red	39.4	50	---	lm
	LL-HP60MUY1L-3W	Yellow	39.4	55	---	lm

### Forward Voltage Characteristics at $I_F=700\text{mA}$ ( $T_a=25^\circ\text{C}$ )

Lens Item	Part No	Color	VF			Units
			Min	Typ	Max	
Lambertian	LL-HP60MW1L-3W	White	2.8	3.5	4.0	V
	LL-HP60MW61L-3W	Warm White	2.8	3.5	4.0	V
	LL-HP60MB1L-3W	Blue	2.8	3.5	4.0	V
	LL-HP60MPG1L-3W	True Green	2.8	3.2	4.0	V
	LL-HP60MV1L-3W	Red	2.0	2.2	2.8	V
	LL-HP60MUY1L-3W	Yellow	2.0	2.2	2.8	V

**Wavelength or Color Temperature Characteristics at IF=700mA (Ta=25°C)**

Lens Item	Part No	Color	$\lambda$ D/CCT			Units
			Min	Typ	Max	
Lambertian	LL-HP60MW1L-3W	White	5000	---	8000	K
	LL-HP60MW61L-3W	Warm White	2850	---	3800	K
	LL-HP60MB1L-3W	Blue	460	---	475	nm
	LL-HP60MPG1L-3W	True Green	515	---	535	nm
	LL-HP60MV1L-3W	Red	620	---	630	nm
	LL-HP60MUY1L-3W	Yellow	585	---	595	nm

**Thermal Resistance Junction to Board Characteristics at IF=700mA(Ta=25°C)**

Lens Item	Part No	Color	R $\theta$ J-P			Units
			Min	Typ	Max	
Lambertian	LL-HP60MW1L-3W	White	---	20	---	°C/W
	LL-HP60MW61L-3W	Warm White	---	20	---	°C/W
	LL-HP60MB1L-3W	Blue	---	20	---	°C/W
	LL-HP60MPG1L-3W	True Green	---	20	---	°C/W
	LL-HP60MV1L-3W	Red	---	20	---	°C/W
	LL-HP60MUY1L-3W	Yellow	----	20	---	°C/W

### Temperature Coefficient Of Forward Voltage Characteristics at $I_F=700\text{mA}(T_a=25^\circ\text{C})$

Lens Item	Part No	Color	$\Delta V_F / \Delta T$			Units
			Min	Typ	Max	
Lambertian	LL-HP60MW1L-3W	White	---	-2	---	$\text{mV}/^\circ\text{C}$
	LL-HP60MW61L-3W	Warm White	---	-2	---	$\text{mV}/^\circ\text{C}$
	LL-HP60MB1L-3W	Blue	---	-2	---	$\text{mV}/^\circ\text{C}$
	LL-HP60MPG1L-3W	True Green	---	-2	---	$\text{mV}/^\circ\text{C}$
	LL-HP60MV1L-3W	Red	---	-2	---	$\text{mV}/^\circ\text{C}$
	LL-HP60MUY1L-3W	Yellow	---	-2	---	$\text{mV}/^\circ\text{C}$

### Reverse Current Characteristics at $V_R=5\text{V}(T_a=25)$

Lens Item	Part No	Color	$I_r (V_r=5\text{V})$			Units
			Min	Typ	Max	
Lambertian	LL-HP60MW1L-3W	White	---	---	50	$\text{mV}/^\circ\text{C}$
	LL-HP60MW61L-3W	Warm White	---	---	50	$\text{mV}/^\circ\text{C}$
	LL-HP60MB1L-3W	Blue	---	---	50	$\text{mV}/^\circ\text{C}$
	LL-HP60MPG1L-3W	True Green	---	---	50	$\text{mV}/^\circ\text{C}$
	LL-HP60MV1L-3W	Red	---	---	50	$\text{mV}/^\circ\text{C}$
	LL-HP60MUY1L-3W	Yellow	---	---	50	$\text{mV}/^\circ\text{C}$

### Emission Angle Characteristics at IF=700mA(Ta=25)

Lens Item	Part No	Color	2θ½			Units
			Min	Typ	Max	
Lambertian	LL-HP60MW1L-3W	White	---	140	---	Degree
	LL-HP60MW61L-3W	Warm White	---	140	---	Degree
	LL-HP60MB1L-3W	Blue	---	140	---	Degree
	LL-HP60MPG1L-3W	True Green	---	140	---	Degree
	LL-HP60MV1L-3W	Red	---	120	---	Degree
	LL-HP60MUY1L-3W	Yellow	---	120	---	Degree

### CCT Ranks

CCT Group	CCT(K) @IF=700mA
Warm White	2,850---3,800
○T	2,850---3,325
○U	3,325---3800
White	5,000---8,000
○W	5,000---6,000
○X	6,000---7,000
○Y	7,000---8,000



**White**
*Chromaticity Coordinates Specifications for Bin Ranks*

<b>Ranks</b>	<b>X</b>	<b>Y</b>	<b>CCT(Typ.)</b>	<b>Ranks</b>	<b>X</b>	<b>Y</b>	<b>CCT(Typ.)</b>
A	0.34	0.359	5350	E	0.316	0.333	6700
	0.344	0.344			0.317	0.320	
	0.329	0.331			0.308	0.311	
	0.329	0.345			0.305	0.322	
B	0.367	0.400	5500	F	0.329	0.369	6300
	0.362	0.372			0.329	0.345	
	0.329	0.345			0.305	0.322	
	0.329	0.369			0.301	0.342	
C	0.329	0.345	6050	G	0.308	0.311	8000
	0.329	0.331			0.311	0.293	
	0.317	0.320			0.290	0.270	
	0.316	0.333			0.283	0.284	
D	0.329	0.331	6300	H	0.303	0.333	8000
	0.330	0.310			0.308	0.311	
	0.311	0.293			0.283	0.284	
	0.308	0.311			0.274	0.301	

**White**

**CIE Chromaticity Diagram**

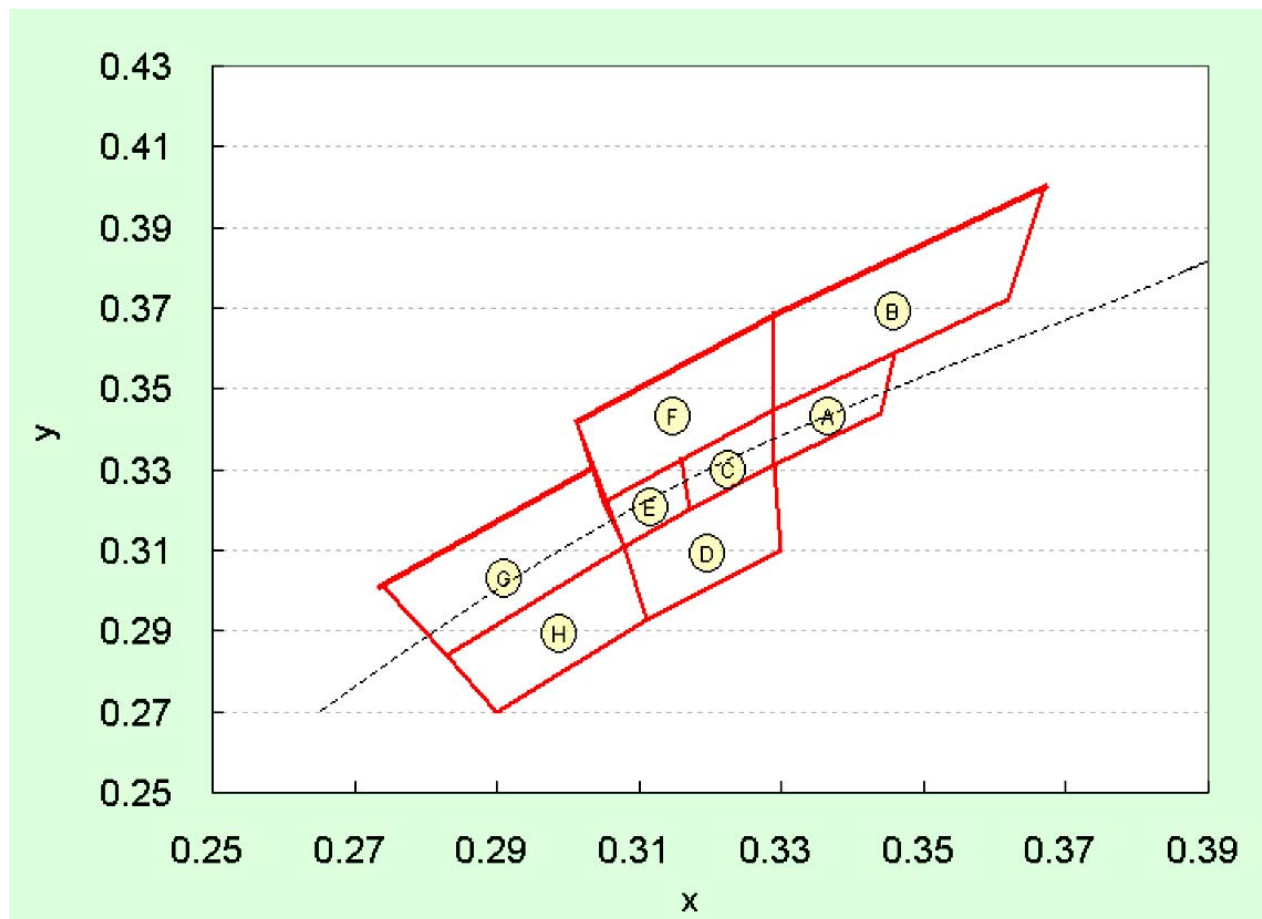

Version: 2.2

*White*

*Chromaticity Coordinates Specifications for Bin Ranks*

Ranks	X	Y	CCT(Typ.)	Ranks	X	Y	CCT(Typ.)
A	0.438	0.412	2950	E	0.409	0.400	3370
	0.429	0.394			0.402	0.382	
	0.444	0.399			0.416	0.389	
	0.453	0.416			0.424	0.406	
B	0.454	0.446	2950	F	0.392	0.391	3640
	0.438	0.412			0.387	0.374	
	0.453	0.416			0.402	0.382	
	0.471	0.451			0.409	0.400	
C	0.424	0.406	3150	G	0.402	0.423	3500
	0.416	0.389			0.392	0.391	
	0.429	0.394			0.424	0.406	
	0.438	0.412			0.438	0.440	
D	0.438	0.440	3150	H	0.387	0.374	3500
	0.424	0.406			0.383	0.360	
	0.438	0.412			0.410	0.374	
	0.454	0.446			0.416	0.389	

*Warm White*

*CIE Chromaticity Diagram*

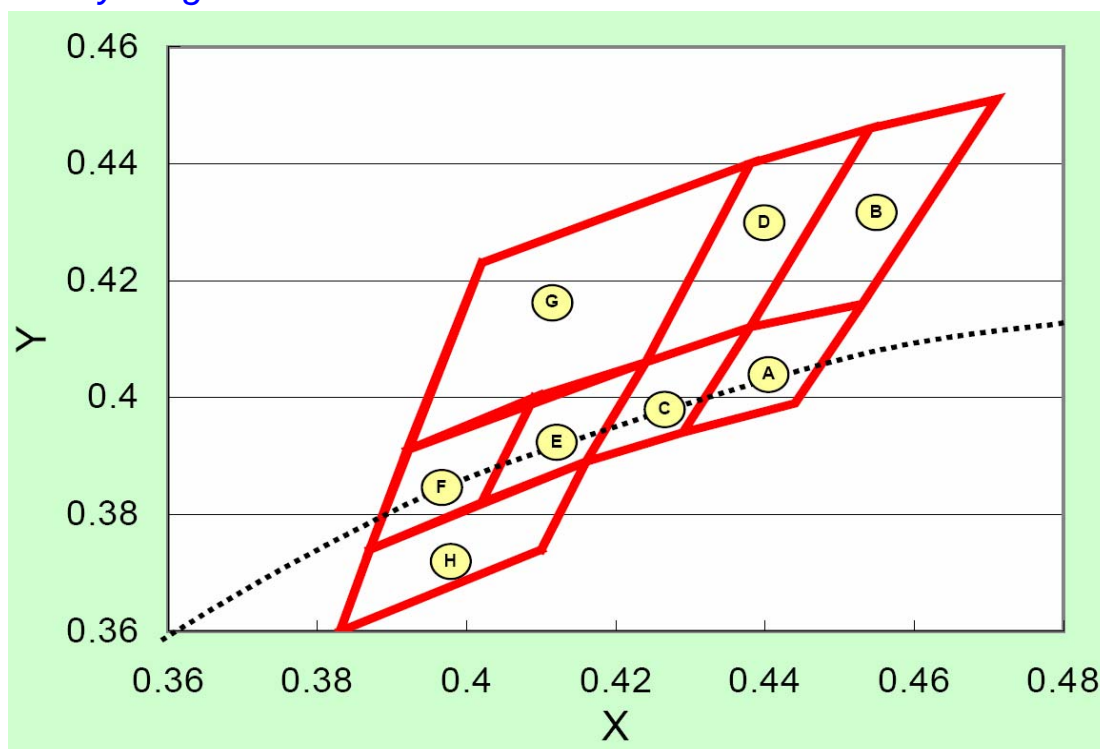

**Wavelength Ranks**

Ranks	$\lambda$ D@IF=700mA
● Blue	<b>460-475</b>
W	460-465
X	465-470
Y	470-475
● True Green	<b>515-535</b>
V	515-520
W	520-525
X	525-530
Y	530-535
● Yellow	<b>585-595</b>
X	585-595
● Red	<b>620-630</b>
X	620-630

**Forward Voltage Ranks For White & True Green & Blue**

Ranks	$\lambda$ D@IF=700mA
Full	2.8-4.0
● V01	2.8-3.1
● V02	3.1-3.4
● V03	3.4-3.7
● V04	3.7-4.0

**Forward Voltage Ranks For Red & Amber**

Ranks	$\lambda$ D@IF=700mA
Full	2.00-2.75
● V01	2.00-2.25
● V02	2.25-2.50
● V03	2.50-2.75

**Note**

1. Flux is measured with an accuracy of  $\pm 15\%$ .
2. CCT selection acc. to CCT groups and an accuracy of  $\pm 400K$
3. Forward Voltage is measured with an accuracy of  $\pm 0.2V$ .
4. Wavelength is measured with an accuracy of  $\pm 3nm$
5. Angle is measured with an accuracy of  $\pm 15$  degree

*Electrical & Optical Curves  
Wavelength Spectrum*

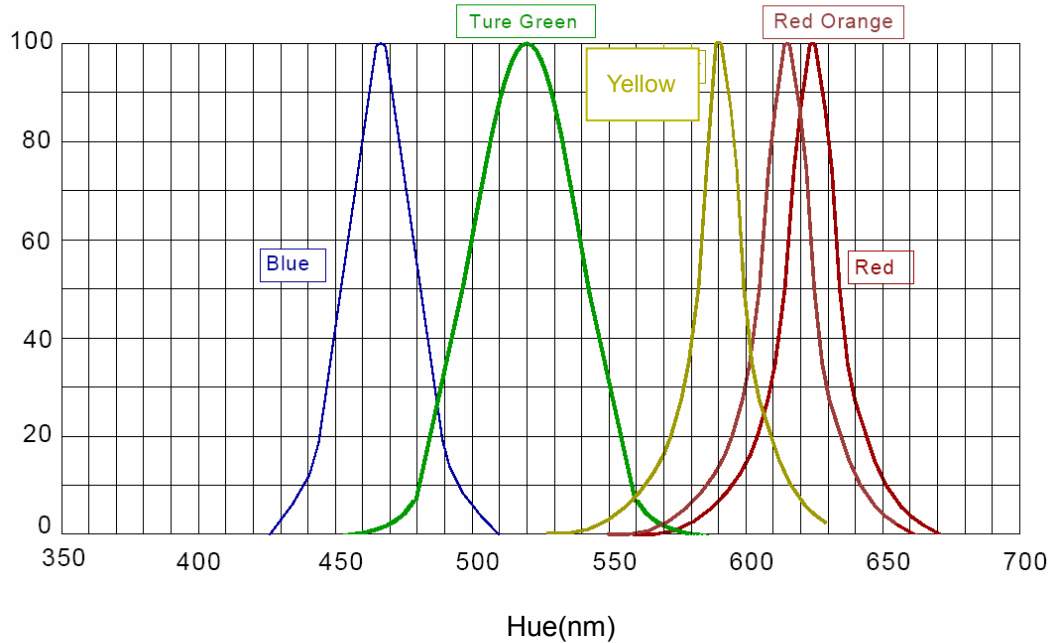
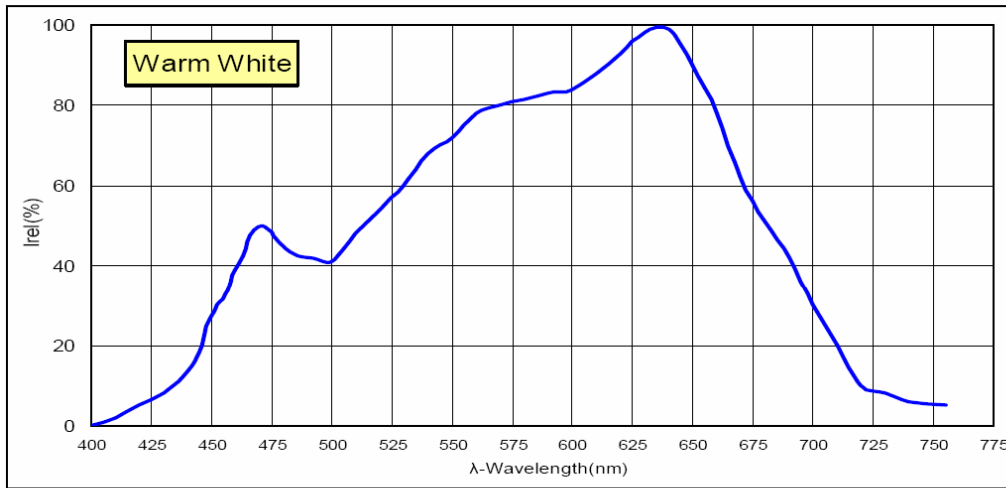
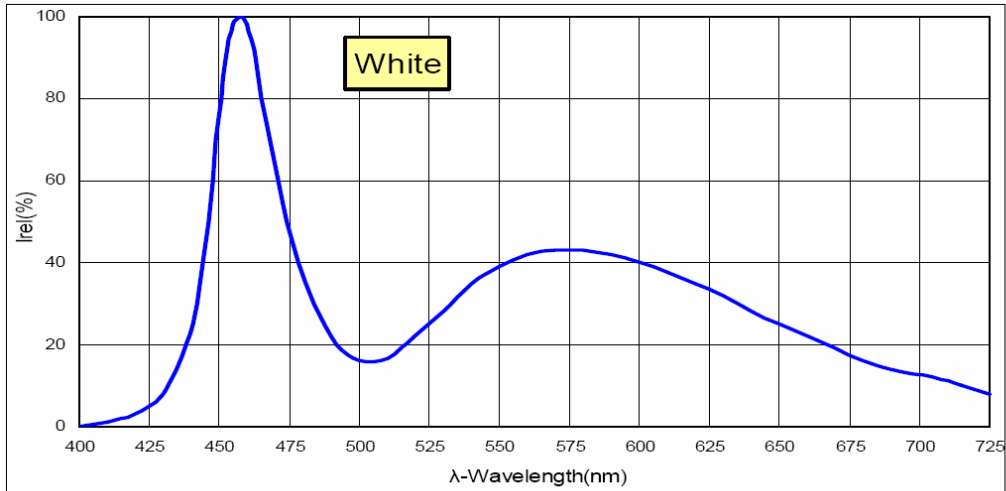

Typical Radiation Pattern for Lambertian

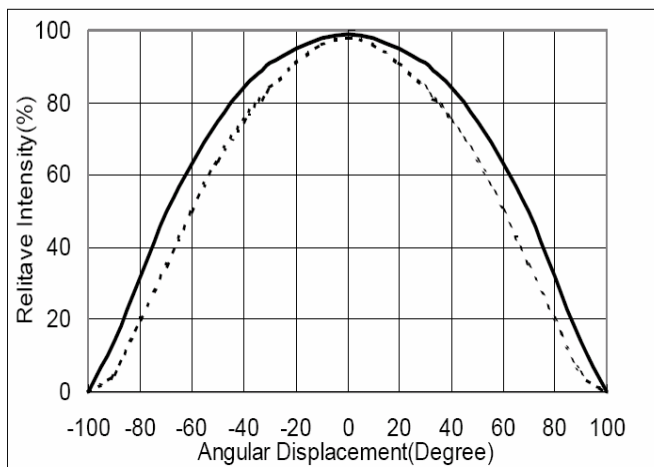

**Current & Luminous Flux**

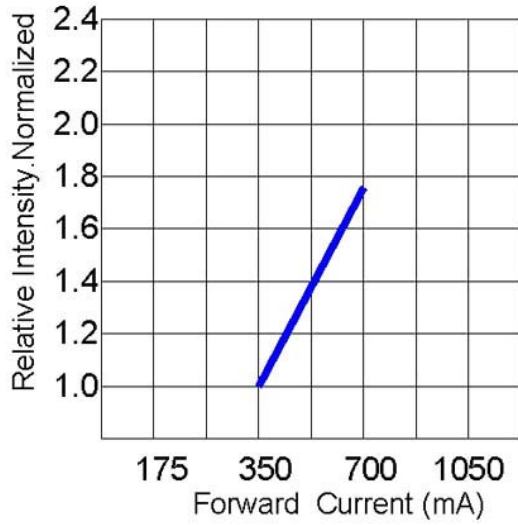

**Operating Current & Ambient Temperature**

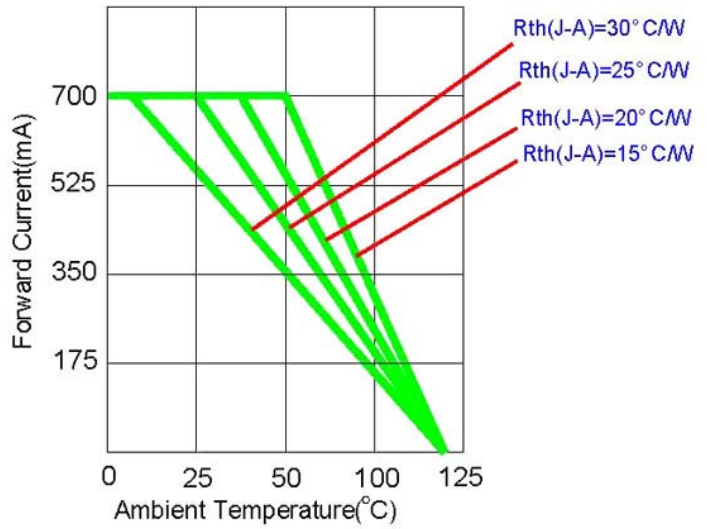

**Operating Current & Forward Voltage**

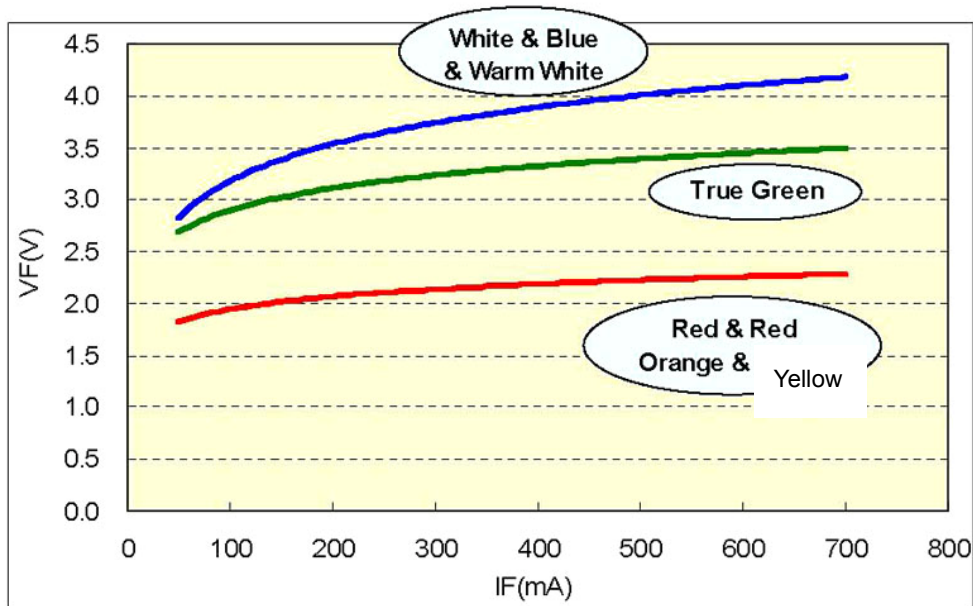



## **Revision Histoty**

Version	Page	Subjects (major change since last revision)	Date
1.0			2004/05/01
1.1			2004/06/08
1.2			2004/07/01
1.3			2004/07/20
2.0			2004/08/20
2.1			2004/11/05
2.2			2004/01/12

## X-ON Electronics

Largest Supplier of Electrical and Electronic Components

*Click to view similar products for [High Power LEDs - White category](#):*

*Click to view products by [Lucky Light manufacturer](#):*

Other Similar products are found below :

[G42180-08](#) [B42180-08](#) [STW8Q2PA-R5-HA](#) [SZ5-M1-W0-00-V3/W2-AA](#) [LTPL-P00DWS57](#) [LZP-D0WW00-0000](#) [CLM-9-30-90-36-AC32-F4-3](#) [SZ5-M1-WW-C8-V1/V3-FA](#) [BXRC-27E2000-D-73](#) [BXRC-27G2000-D-73](#) [BXRC-30E1000-D-73](#) [BXRC-30G2000-D-73](#) [BXRC-40E1000-D-73](#) [BXRE-30G2000-B-73](#) [BXRE-30G2000-C-73](#) [BXRE-50C2001-C-74](#) [CXM-22-27-80-54-AC30-F4-3](#) [XHP50B-00-0000-0D0UH245G](#) [XHP50B-00-0000-0D0UH240G](#) [XHP50B-00-0000-0D0UG227H](#) [XHP50B-00-0000-0D0HJ245G](#) [MP-5050-8100-27-80](#) [MP-5050-6100-65-80](#) [MP-5050-6100-50-80](#) [MP-5050-6100-40-80](#) [MP-5050-6100-30-80](#) [CXM-22-30-80-54-AC30-F4-3](#) [LTW-2835SZK57](#) [BXEM-50C0000-0-000](#) [WW-WNA30TS-U1\(M1\)](#) [KW CSLPM2.CC-8L8M-4L8N](#) [KW CSLPM2.CC-8L8M-4O9Q](#) [KW DPLS32.SB-6H6J-E5P7-EG-Z264](#) [L1V1-507003V500000](#) [CXM-22-35-80-36-AC10-F3-3](#) [KW3 CGLNM1.TG-Z6QF6-EBVFFCBB46-DFGA](#) [JB5630AWT-H-H65EA0000-NZ000001](#) [XHP50B-00-0000-0D0UG430H](#) [CXM-22-35-90-54-AC40-F5-3](#) [CXM-22-35-80-54-AC40-F5-3](#) [OSM51206E1N-0.8T](#) [OSW43020C1C](#) [MP161611032290](#) [MP-1616-2103-50-90](#) [KW CULPM1.TG-Z6RF7-ebvFfcbB46-65G5](#) [KW DMLS33.SG-Z6M7-EBVFFCBB46-8E8G-700-S](#) [XPGDWT-B1-0000-00EEA](#) [XHP70B-00-0000-0D0BP450E](#) [KW DMLN33.SG-7J7K-EBVFFCBB46-8E8G-200-S](#) [ASMT-MW05-NMNS1](#)