

TDH-8070/8071

ON RELEASE-FIXED PERIOD
2 PDT, 10 AMP

ENGINEERING DATA SHEET

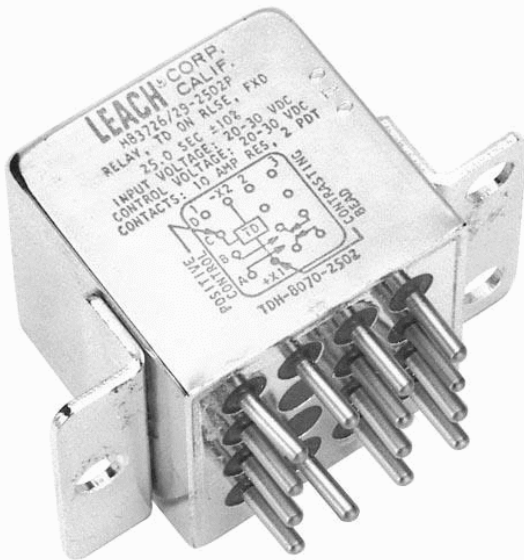

APPLICATION NOTE:

[101](#)

APPLICABLE SOCKET:

[SO-1048-8308](#)

FEATURES

- Small size and weight
- High-reliability design
- Hermetically sealed
- High transient immunity
- Reverse Polarity Protection

PRINCIPLE TECHNICAL CHARACTERISTICS

Seal: Hermetic Tested per MIL-STD-883,
Method 1014 Condition B, C

Finish: per MIL-T-10727

Terminals:

TDH 8071 (Tin Plate)

TDH 8071 (Gold Plate)

Weight

1×10^{-8} atm, cm³/s max
leakage
Tin Plate

Solder-lug
Plug-In

2.5 Ounce max.

DESCRIPTION

The TDH-8070/71 Time Delay Relays have been designed with thick film hybrid microelectronics timing circuits and MIL-PRF-6106 relays, packaged in a hermetically sealed military style enclosure. The TDH-8070/71 series are qualified to MIL-R-83726/29 and designed to withstand severe environmental conditions encountered in military/aerospace applications. These relays are suited for use in power control, communication circuits and many other applications where power switching and high reliability are required over a wide temperature range.



Leach International
www.leachintl.com

North America
6900 Orangethorpe Ave.
P.O. Box 5032
Buena Park, CA 90622 USA

Tel: (01) 714-736-7599
Fax: (01) 714-670-1145

Europe, SA
2 Rue Goethe
57430 Sarralbe
France

Tel: (33) 3 87 97 98 97
Fax: (33) 3 87 97 84 04

Asia-Pacific Ltd.
20/F Shing Hing Commercial Bldg.
21-27 Wing Kut Street
Central, Hong Kong

Tel: (852) 2 191 2886
Fax: (852) 2 389 5803

Data sheets are for initial product selection and comparison. Contact Leach International prior to choosing a component.

Timing: a. Operation, Time Delay on b. Method c. Range d. Accuracy	Release Fixed Period 0.1 to 600 Seconds [6] ±10% [1]
Recycle Time	50 ms, Max [5]
Operations: (X1-X2) a. Input & Control Voltage b. Operating Current c. Control Current	20-30 Vdc 150 mA, Max @ 25° C 15 mA, Max @ 25° C
Transients: a. Positive, MIL-STD-704A, Figure9, Limit 1 b. Spike, MIL-STD-704A, 0-10 µs c. Self-Generated d. Susceptibility	+80 Volts Max ±600 Volts Max ±50 Volts Max +80; -600 Volts Max
Electromagnetic Interference Per MIL-STD-461A	Class 1D [3]
Power Loss	500 Microseconds [2]
Output (Load) Parameters	
Contact Form Contact Rating: a. Resistive b. Inductive c. Motor d. Lamp	2 PDT 10 Amperes 8 Amperes 4 Amperes 2 Amperes
Dielectric Strength: a. @ Sea Level, 60 Hz b. @ 80,000 ft., 60 Hz	1000 Vrms [4] 350 Vrms
Insulation Resistance @ 500 Vdc	1000 M Ω [4]

GENERAL CHARACTERISTICS

Ambient Temperatures Range: a. Operating b. Non-Operating	-55 to +125° C -65 to +125° C
Vibration:	
a. Sinusoidal, 10-3000 Hz	30 G
b. Random: 50-2000 Hz, MIL-STD-810	0.4 G ² /Hz
Shock @ 6 ± 1 MS, 1/2 Sine, 3 Axis	100 G
Acceleration, in any Axis	15 G
Life at Rated Resistive Load; Minimum	100,000 operations

NUMBERING SYSTEM

<table border="0"> <tr> <td colspan="4">Plug-in Terminal</td> <td colspan="4">Solder Hook Terminal</td> </tr> <tr> <td><u>TDH-8070</u></td> <td>-</td> <td><u>1001</u></td> <td><u>P</u></td> <td><u>TDH-8071</u></td> <td>-</td> <td><u>1001</u></td> <td><u>S</u></td> </tr> <tr> <td> </td> <td> </td> <td> </td> <td> </td> <td> </td> <td> </td> <td> </td> <td> </td> </tr> <tr> <td>1</td> <td></td> <td>3</td> <td>4</td> <td>1</td> <td></td> <td>3</td> <td>4</td> </tr> <tr> <td colspan="4"><u>M83726/29</u></td> <td colspan="4"><u>M83726/29</u></td> </tr> <tr> <td>-</td> <td></td> <td>-</td> <td><u>P</u></td> <td>-</td> <td></td> <td>-</td> <td><u>S</u></td> </tr> <tr> <td> </td> <td> </td> <td> </td> <td> </td> <td> </td> <td> </td> <td> </td> <td> </td> </tr> <tr> <td>1</td> <td>2</td> <td>3</td> <td>4</td> <td>1</td> <td>2</td> <td>3</td> <td></td> </tr> </table>	Plug-in Terminal				Solder Hook Terminal				<u>TDH-8070</u>	-	<u>1001</u>	<u>P</u>	<u>TDH-8071</u>	-	<u>1001</u>	<u>S</u>									1		3	4	1		3	4	<u>M83726/29</u>				<u>M83726/29</u>				-		-	<u>P</u>	-		-	<u>S</u>									1	2	3	4	1	2	3		<ol style="list-style-type: none"> 1. Model Number or Basic "MIL-PRF" Series number. 2. Military "Slash" number. 3. Timing Range, Fixed: 100 milliseconds to 600 seconds. (See Note 6). 4. Mounting style and quality level (See Note 7).
Plug-in Terminal				Solder Hook Terminal																																																													
<u>TDH-8070</u>	-	<u>1001</u>	<u>P</u>	<u>TDH-8071</u>	-	<u>1001</u>	<u>S</u>																																																										
1		3	4	1		3	4																																																										
<u>M83726/29</u>				<u>M83726/29</u>																																																													
-		-	<u>P</u>	-		-	<u>S</u>																																																										
1	2	3	4	1	2	3																																																											
<p>P = Plug-in terminal. S = Solder hook terminal.</p>																																																																	

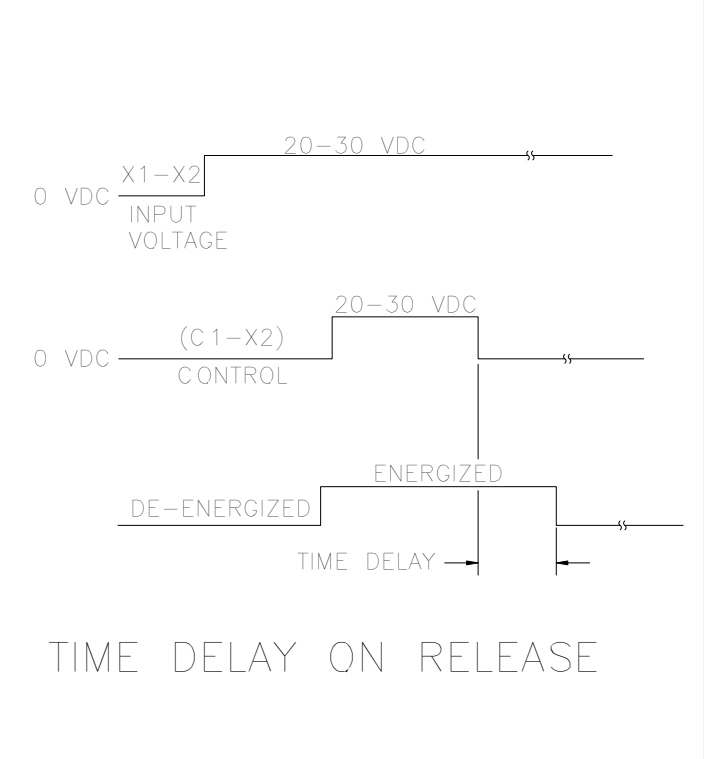
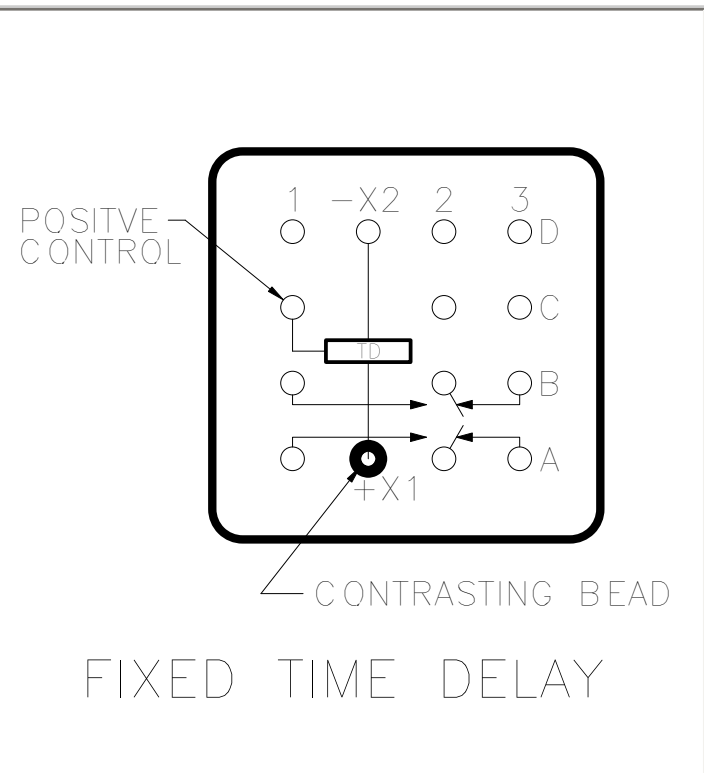
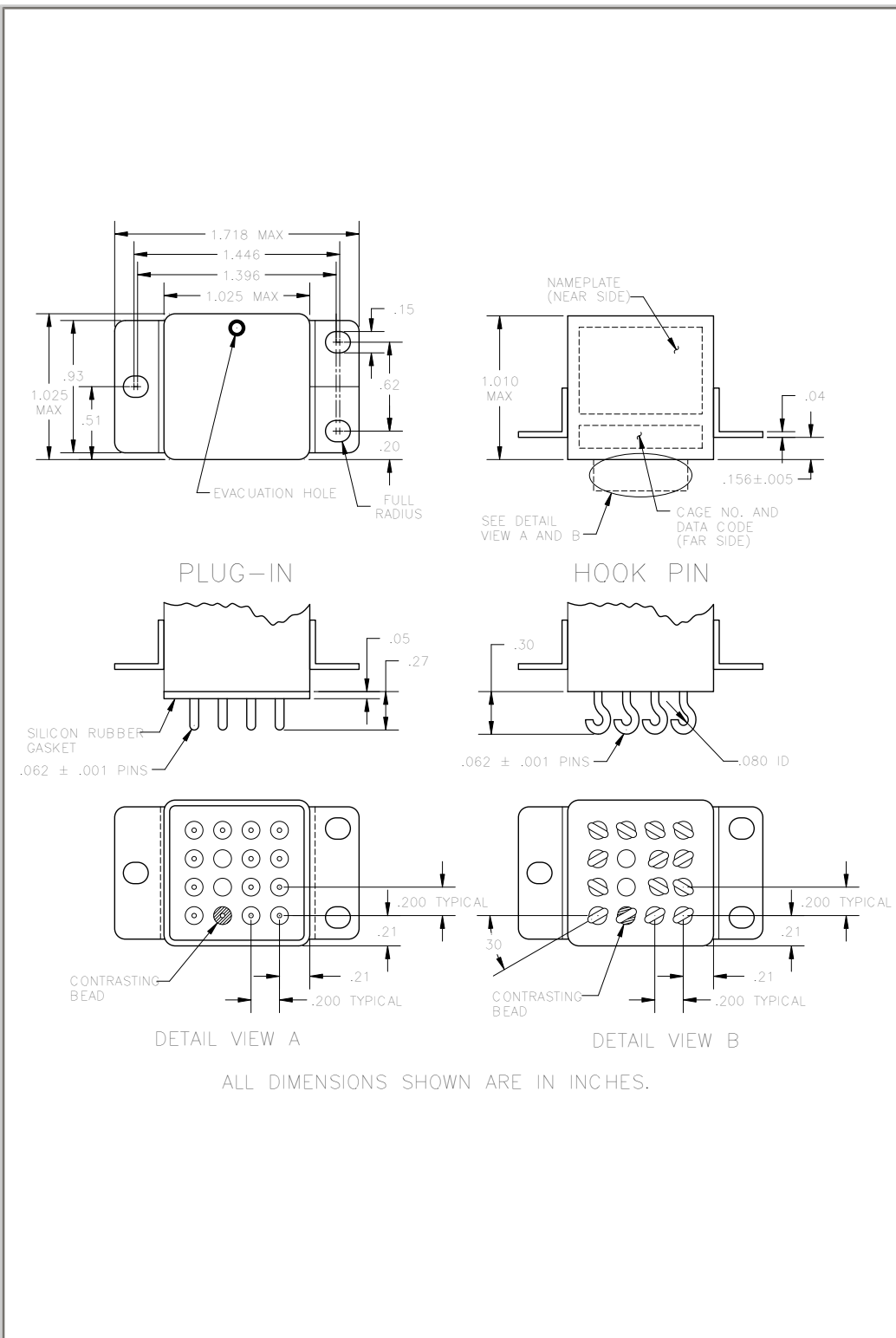

NOTES

- [1] The accuracy specification applies for any combination of operating temperature and voltage. For units with a timing range less than 1 second, add ± 10 milliseconds to the $\pm 10\%$ tolerance.
- [2] Transient and power loss specification are based on a maximum duty cycle of 1/50.
- [3] EMI test limits will not be exceeded during the timing interval or when continuously energized under steady state conditions, per paragraph 3.23, MIL-PRF-83726C.
- [4] Terminals X1, X2 and C1 must be connected together during the test. Dielectric withstanding voltage and insulation resistance are measured at sea level between all mutually insulated terminals and between all terminals and case.
- [5] Recycle time is defined as the minimum time that power must be applied to the control terminal to assure that the next timing cycle will be completed within the specified timing tolerance. (Units can be recycled during timing or after time-out.)
- [6] Time delays greater than 500 seconds are not MIL qualified. A four digit number defines the time delay range in seconds (or milliseconds). The first three digits are significant figures, used to define the specific time delay. The fourth digit represents the number of zeros to follow the first three digits.
 Examples: - 1001 = 1 second (1,000 milliseconds)
 - 2502 = 25 seconds (25,000 milliseconds)
 - 5000 = 0.5 seconds (500 milliseconds)
- [7] Quality level as specified in MIL-R-83726B, paragraph 3.1.1, 3.1.2 and 3.1.3.

DERATING OF CONTACTS FOR DC VOLTAGES ABOVE NOMINAL RATING

To establish a standard for the derating of relay contacts is, at best, a subjective practice. Limitations are governed by the type of relay, contact gap, maximum voltage capabilities of the relay contact system, and the contact material.

The most common method is to derate the contacts by use of the Power Formula, using the known current and voltage.

This method is valid only for **Resistive Loads**, and is an approximation only; keeping in mind the limitations mentioned above.

$$\text{Power} = IE \text{ (Current x Voltage)}$$

$$I_2 E_2 = 2/3 I_1 E_1$$

Example:

A designer is working with a 55 volt DC system and has a relay rated at 10 amps resistive at 28 volts DC. What is the maximum current that can be switched at 55 Vdc.

$$I_1 = 10 \text{ Amperes}$$

$$E_1 = 28 \text{ VDC}$$

$$E_2 = 55 \text{ VDC}$$

$$I_2 = ? \text{ (Current ratings at 55 VDC Resistive)}$$

$$I_2 E_2 = 2 I_1 E_1 / 3$$

$$I_2 = 2 I_1 E_1 / E_2 \cdot 3$$

$$= 2 (10 \times 28) / 55 \times 3$$

$$= 560 / 165$$

$$I_2 = 3.4 \text{ Amperes at 55VDC}$$

In addition, the user should always be concerned about the following:

1. Derating contacts that are rated for less than 10 Amperes at nominal voltage.
2. Derating contacts for use in system voltages above 130 Volts DC

SO-1048-8308/8518

ENGINEERING DATA SHEET

RELAY SOCKET
12 AMP



BASIC SOCKET SERIES DESIGNATION FOR:

Series K

Series TDH-8070, TDH-8080

TDH-8050, TDH-8060, VS400

DESIGNED TO THE STANDARDS AND REQUIREMENTS OF:

MIL-S-12883/40

SOCKET DRAWING

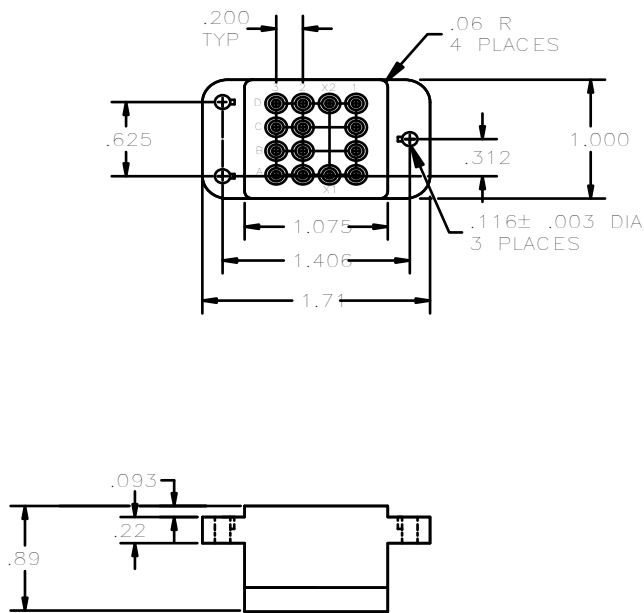

HARDWARE MOUNTING

MOUNTING DETAIL 3 PLACES

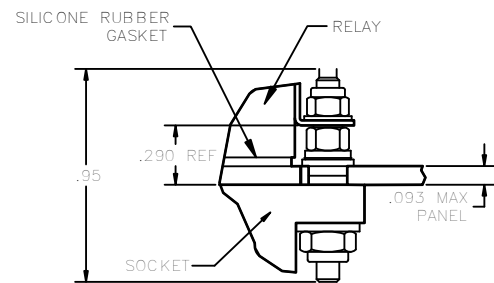

BOTTOM MOUNT-CLEARANCE
HOLE FOR .192 SCREW
TOP MOUNT-CLEARANCE
HOLE FOR .112 SCREW

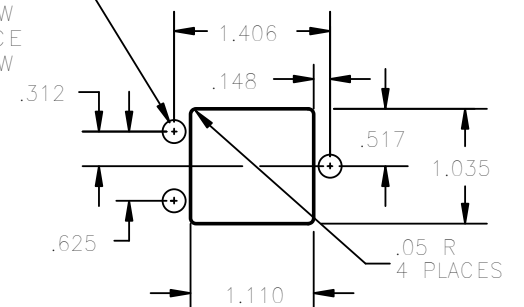

MOUNTING DIMENSIONS

GENERAL CHARACTERISTICS

1. Supplied with mounting hardware and No. 16 contacts, No. 16 crimp (SO-1048-8308); No. 16 contacts, No. 20 crimp (SO-1048-8518).	
2. Standard tolerances	.xx ±.01; xxx ±.005
3. Weight	.115 lb. max
4. Temperature range	-70° C to +125° C



Leach International
www.leachintl.com

North America
6900 Orangethorpe Ave.
P.O. Box 5032
Buena Park, CA 90622 USA

Tel: (01) 714-736-7599
Fax: (01) 714-670-1145

Europe, SA
2 Rue Goethe
57430 Sarralbe
France

Tel: (33) 3 87 97 98 97
Fax: (33) 3 87 97 84 04

Asia-Pacific Ltd.
20/F Shing Hing Commercial Bldg.
21-27 Wing Kut Street
Central, Hong Kong

Tel: (852) 2 191 2886
Fax: (852) 2 389 5803

Data sheets are for initial product selection and comparison. Contact Leach International prior to choosing a component.

X-ON Electronics

Largest Supplier of Electrical and Electronic Components

Click to view similar products for [esterline](#) manufacturer:

Other Similar products are found below :

[KC-A1N](#) [M83536/32-003L](#) [SO-1056-8691](#) [9123-8070](#) [K-D4A](#) [X-J7B](#) [S320-A1A10](#) [J-J7A-012](#) [VS-455-1](#) [TDH-2016-1002](#) [M83536/5-024M](#)
[S283A004-7](#) [9130G-10677](#) [9524-6507](#) [X-A2N](#) [X-A1N](#) [KL-D4L-029](#) [TDH-7101-2002](#) [JC-D1N](#) [Y-D4N-300L](#) [002-5089-000](#) [JA-D4E](#)
[M83726/30-1001P](#) [002-3261-000](#) [M83726/24-1001](#) [M6106/19-017](#)