

Amphenol® SJT Subminiature Cylindrical Connectors

12-091-11



Amphenol

| Table of Contents | Page No. |
|---|-----------------|
| General Information | 1 |
| Specifications, Alternate Rotations | 2 |
| Insert Availability and Identification | 3 |
| Insert Arrangements | 4, 5, 6, 7, 8 |
| Crimp | |
| SJT00RT Wall Mounting Receptacle | 9 |
| SJTP00RT Wall Mounting Receptacle, (back panel mounting) | 10 |
| SJTP02RE Box Mounting Receptacle, (back panel mounting) | 11 |
| SJT06RT Straight Plug/SJTG06RT Straight Plug (with grounding fingers) | 12 |
| SJT07RT Jam Nut Receptacle | 13 |
| Hermetic | |
| SJTIY Solder Mounting Receptacle | 14 |
| SJT07Y Jam Nut Receptacle | 15 |
| Contacts, Sealing Plugs, Plastic Protection Caps | 16 |
| Accessories | |
| Plug Protection Cap/Receptacle Protection Cap | 17 |
| Dummy Receptacle, Cable Clamp | 18 |
| Application Tools | 19 |
| How to Order | 20 |
| Sales Office Listing | |

Amphenol® SJT

100% scoop-proof junior tri-lock subminiature cylindrical



wall mounting receptacle



straight plug



jam nut receptacle

Amphenol® SJT connectors combine unique design features of the scoop-proof LJT series within standard mounting dimensions of JT types. Available in a wide range of shell sizes, finishes, insert arrangements and accessories, the SJT features:

- **100% scoop-proof design** – basic MIL-DTL-38999 Series I* lengths
- **Standard mounting dimensions** – MIL-DTL-38999, Series III** dimensions
- **Compliance with European Specifications** – PAN6433-2, LN29729, BS9522F0012, VG96912

Components

Shell components are aluminum. Standard plating on shell components is cadmium over nickel with many optional finishes available. Hermetic seal receptacles are available in carbon steel or stainless steel shells. Dependable 5 key/keyway shell polarization with bayonet lock coupling is incorporated to aid and assure positive mating.

Insert material is a high temperature, rigid dielectric polymer providing excellent electrical characteristics. Contrasting letter or number designations are used on insert faces.

A fluorinated silicone interfacial seal is featured on the mating face of pin inserts, assuring complete electrical isolation of pins when connector halves are mated. In addition, a main joint gasket is installed in the receptacles for moisture sealing between connector halves.

Serrated and threaded shells with moisture sealing pilot for back shells accept a wide range of accessories.

Contacts

Standard contact plating is 50 micro inches minimum gold. Power contacts are available in sizes 10, 12, 16, 20, 22, 22M and 22D. Size 8 and 12 twinax contacts are also available. Concentric twinax contact information is available in Amphenol brochure SL-388. All socket contacts are probe proof. Rear insertable/rear release crimp contacts are standard in SJT connectors. High density insert patterns are available.

Coaxial contacts are available in sizes 8, 12 and 16 to accommodate a wide range of coaxial cables. For complete information see Coaxial Contact catalog 12-130.

Optional Features

Special adaptations of the SJT are available for hermetic and high temperature applications. The SJTS high temperature connector is rated at 392°F. SJT hermetic receptacles are described on pages 14 and 15.

Specials

Special types are available, such as connectors less contacts, and circular rack and panel connectors with solderless wrap contacts.

A complete listing of connector types, shell styles and service classes appears on page 20, How to Order. For further information on special application requirements, contact Sidney N.Y.

SJT specifications, alternate rotations

CONTACT RATING

| Contact Size | Test Current | | Maximum Millivolt Drop Crimp* | Maximum Millivolt Drop Hermetic |
|--------------|--------------|----------|-------------------------------|---------------------------------|
| | Standard | Hermetic | | |
| 22M | 3 | 2 | 45 | 60 |
| 22D | 5 | 3 | 73 | 85 |
| 22 | 5 | 3 | 73 | 85 |
| 20 | 7.5 | 5 | 55 | 60 |
| 16 | 13 | 10 | 49 | 85 |
| 12 | 23 | 17 | 42 | 85 |
| 10 Power | 33 | NA | 33 | NA |

| Contact Size | Crimp Well Data | |
|--------------|-----------------|-----------------|
| | Well Diameter | Min. Well Depth |
| 22M | .028 ±.001 | .141 |
| 22D | .0345 ±.0010 | .141 |
| 22 | .0365 ±.0010 | .141 |
| 20 | .047 ±.001 | .209 |
| 16 | .067 ±.001 | .209 |
| 12 | .100 ±.002 | .209 |
| 10 (Power) | .137 ±.002 | .355 |

* When using silver plated wire

SERVICE RATING**

| Service Rating | Suggested Operating Voltage (Sea Level) | | Test Voltage (Sea Level) | Test Voltage 50,000 Ft. | Test Voltage 70,000 Ft. | Test Voltage 110,000 Ft. |
|----------------|---|------|--------------------------|-------------------------|-------------------------|--------------------------|
| | AC(RMS) | DC | | | | |
| M | 400 | 550 | 1300 VRMS | 550 VRMS | 350 VRMS | 200 VRMS |
| N | 300 | 450 | 1000 VRMS | 400 VRMS | 260 VRMS | 200 VRMS |
| I | 600 | 850 | 1800 VRMS | 600 VRMS | 400 VRMS | 200 VRMS |
| II | 900 | 1250 | 2300 VRMS | 800 VRMS | 500 VRMS | 200 VRMS |

** Please note that the establishment of electrical safety factors is left entirely in the designer's hands, since he is in the best possible position to know what peak voltage, switching surges, transients, etc., can be expected in a particular circuit.

FINISH DATA

| Aluminum Shell Components Non-Hermetic | | |
|---|--------------------|---|
| Finish | Suffix | Indicated Finish Standard for SJT Types |
| Bright Cadmium Plated Nickel Base | | SJT/SJTG |
| Anodic Coating (Alumilite) | (005) | |
| Chromate Treated (Iridite 14-2) | (011) | |
| Olive Drab Cadmium Plate Nickel Base | (014) | |
| Electroless Nickel Coating | (023) | |
| Hermetic Connectors | | |
| Carbon Steel Shell, Tin Plated Shell and Contacts | | SJT()Y |
| Stainless Steel Shell, Gold Plated Contacts | Consult Sidney, NY | |

SJT ALTERNATE ROTATIONS

A plug with a given rotation letter will mate with a receptacle with the same rotation letter. The AB angle for a given connector is the same whether it contains pins or sockets. Inserts are not rotated in conjunction with the master key/keyway.

AB angles shown are viewed from the front face of the connector. A receptacle is shown at right. The angles for the plug are exactly the same, except the direction of rotation is opposite of that shown for the receptacle.

Master Key/Keyway Rotation

AB ANGLE OF ROTATION (Degrees)

| Shell Size | Normal | A | B | C | D |
|------------|--------|----|----|-----|-----|
| 8 | 95 | | | | |
| 10 | 95 | 81 | 67 | 123 | 109 |
| 12 | 95 | 75 | 63 | 127 | 115 |
| 14 | 95 | 74 | 61 | 129 | 116 |
| 16 | 95 | 77 | 65 | 125 | 113 |
| 18 | 95 | 77 | 65 | 125 | 113 |
| 20 | 95 | 77 | 65 | 125 | 113 |
| 22 | 95 | 80 | 69 | 121 | 110 |
| 24 | 95 | 80 | 69 | 121 | 110 |

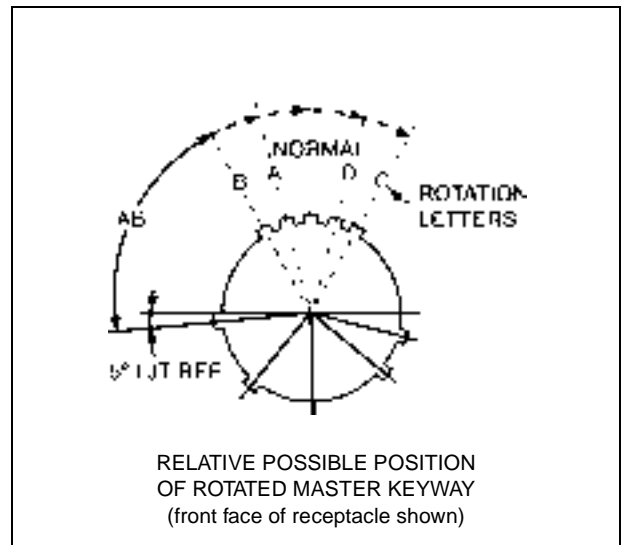

SJT

insert availability and identification

| Shell Size | Crimp | Hermetics* Class Y | Service Rating | Total Contacts | Contact Size | | | | | | | | | | |
|------------|-------|-----------------------|----------------|----------------|--------------|-----|-----|----|-------|----|-----------|------------|----------|---------------|-----|
| | | | | | 22D | 22M | 22 | 20 | 16 | 12 | 12 (Coax) | 10 (Power) | 8 (Coax) | 8††† (Twinax) | |
| 8-6 | X | | M | 6 | | 6 | | | | | | | | | |
| 8-35 | X | | M | 6 | 6 | | | | | | | | | | |
| 8-44 | X | | M | 4 | | | 4 | | | | | | | | |
| 8-98 | X | | I | 3 | | | | 3 | | | | | | | |
| 10-2 | ◆ | | I | 2 | | | | | 2 | | | | | | |
| 10-4 | ◆ | | I | 4 | | | | 4 | | | | | | | |
| 10-5 | ◆ | | I | 5 | | | | 5 | | | | | | | |
| 10-13 | X | | M | 13 | | 13 | | | | | | | | | |
| 10-35 | X | | M | 13 | 13 | | | | | | | | | | |
| 10-98 | X | | I | 6 | | | | 6 | | | | | | | |
| 12-4 | X | | I | 4 | | | | | 4 | | | | | | |
| 12-8 | X | | I | 8 | | | | 8 | | | | | | | |
| 12-22 | X | | M | 22 | | 22 | | | | | | | | | |
| 12-35 | X | | M | 22 | 22 | | | | | | | | | | |
| 12-98 | X | X | I | 10 | | | | 10 | | | | | | | |
| 14-5 | X | | II | 5 | | | | | 5 | | | | | | |
| 14-15 | X | | I | 15 | | | | 14 | 1 | | | | | | |
| 14-18 | X | | I | 18 | | | | 18 | | | | | | | |
| 14-19 | X | X | I | 19 | | | | 19 | | | | | | | |
| 14-35 | X | X | M | 37 | 37 | | | | | | | | | | |
| 14-37 | X | X | M | 37 | | 37 | | | | | | | | | |
| 14-97 | ◆ | | I | 12 | | | | 8 | 4 | | | | | | |
| 16-2 | ◆ | | M | 39 | 38 | | | | | | | | | | 1** |
| 16-6 | X | | I | 6 | | | | | | 6 | | | | | |
| 16-8 | X | | II | 8 | | | | | 8 | | | | | | |
| 16-13 | ◆ | | I | 13 | | | | | 13 | | | | | | |
| 16-26 | X | | I | 26 | | | | 26 | | | | | | | |
| 16-35 | X | | M | 55 | 55 | | | | | | | | | | |
| 16-42 | ◆ | | M | 42 | | | 42 | | | | | | | | |
| 16-55 | X | | M | 55 | | 55 | | | | | | | | | |
| 16-99 | X | X | I | 23 | | | | 21 | 2 | | | | | | |
| 18-11 | X | | II | 11 | | | | | 11 | | | | | | |
| 18-32 | X | | I | 32 | | | | 32 | | | | | | | |
| 18-35 | X | X | M | 66 | 66 | | | | | | | | | | |
| 18-66 | X | X | M | 66 | | 66 | | | | | | | | | |
| 20-1 | X | X | M | 79 | | 79 | | | | | | | | | |
| 20-2 | X | | M | 65 | | | 65 | | | | | | | | |
| 20-11 | ◆ | | I | 11 | | | | | | 11 | | | | | |
| 20-16 | X | | II | 16 | | | | | 16 | | | | | | |
| 20-35 | X | X | M | 79 | 79 | | | | | | | | | | |
| 20-39 | X | | I | 39 | | | | 37 | 2 | | | | | | |
| 20-41 | X | | I | 41 | | | | 41 | | | | | | | |
| 20-75 | ◆ | | M | 4 | | | | | | | | | | 4†† | |
| 20-79 | ◆ | | II | 19 | 17 | | | | | | | | | 2† | |
| 22-1 | X | X | M | 100 | | 100 | | | | | | | | | |
| 22-2 | X | | M | 85 | | | 85 | | | | | | | | |
| 22-21 | X | | II | 21 | | | | | 21 | | | | | | |
| 22-35 | X | X | M | 100 | 100 | | | | | | | | | | |
| 22-53 | X | | I | 53 | | | | 53 | | | | | | | |
| 24-1 | X | | M | 128 | | 128 | | | | | | | | | |
| 24-2 | X | | M | 100 | | | 100 | | | | | | | | |
| 24-4 | X | | I | 56 | | | | 48 | 8 | | | | | | |
| 24-7 | ◆ | | M | 99 | 97 | | | | | | | | | | 2** |
| 24-11 | ◆ | | N | 11 | | | | 2 | | | | 9 | | | |
| 24-19 | ◆ | | I | 19 | | | | | | 19 | | | | | |
| 24-20 | ◆ | | N | 30 | | | | 10 | 13*** | | 4 | | | | 3 |
| 24-24 | X | | I | 24 | | | | | 12 | 12 | | | | | |
| 24-29 | X | | I | 29 | | | | | 29 | | | | | | |
| 24-35 | X | | M | 128 | 128 | | | | | | | | | | |
| 24-37 | ◆ | | I | 37 | | | | | 37 | | | | | | |
| 24-43 | ◆ | | I | 43 | | | | 23 | 20 | | | | | | |
| 24-46 | ◆ | | I | 46 | | | | 40 | 4 | | | | | 2†† | |
| 24-61 | X | | I | 61 | | | | 61 | | | | | | | |

◆ not tooled for 02-RE

* Pin inserts only (contact Sidney, NY for socket availability).

** twinax contacts for MIL-C-17/176-00002 cable.

*** Two size 16 contacts dedicated to fiber optics. Consult Sidney, NY or Catalog Section 12-352 for fiber optic information.

† must be ordered separately

†† Coax Contacts for RG180 or RG195 cable.





††† Size 8 Coax and Twinax are interchangeable.





For availability of size 12 twinax contacts, consult Amphenol, Sidney, NY





SJT





insert arrangements

front face of pin inserts illustrated

| | | | | | |
|---------------------------|---|---|---|---|---|
| |  |  |  |  |  |
| Insert Arrangement | 8-6 | 8-35 | 8-44 | 8-98 | 10-2 |
| Service Rating | M | M | M | I | I |
| Number of Contacts | 6 | 6 | 4 | 3 | 2 |
| Contact Size | 22M | 22D | 22 | 20 | 16 |

| | | | | | |
|---------------------------|---|---|---|---|---|
| |  |  |  |  |  |
| Insert Arrangement | 10-4 | 10-5 | 10-13 | 10-35 | 10-98 |
| Service Rating | I | I | M | M | I |
| Number of Contacts | 4 | 5 | 13 | 13 | 6 |
| Contact Size | 20 | 20 | 22M | 22D | 20 |

| | | | | | |
|---------------------------|---|---|---|---|---|
| |  |  |  |  |  |
| Insert Arrangement | 12-4 | 12-8 | 12-22 | 12-35 | 12-98 |
| Service Rating | I | I | M | M | I |
| Number of Contacts | 4 | 8 | 22 | 22 | 10 |
| Contact Size | 16 | 20 | 22M | 22D | 20 |

| | | | | | |
|---------------------------|---|---|---|---|---|
| |  |  |  |  |  |
| Insert Arrangement | 14-5 | 14-15 | 14-18 | 14-19 | 14-35 |
| Service Rating | II | I | I | I | M |
| Number of Contacts | 5 | 14 1 | 18 | 19 | 37 |
| Contact Size | 16 | 20 16 | 20 | 20 | 22D |

CONTACT LEGEND













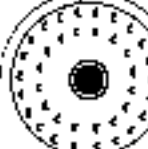

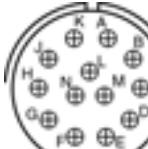

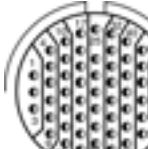
8 10 12 16 20 22 22M 22D

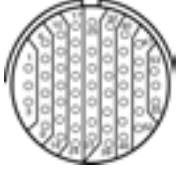
SJT

insert arrangements

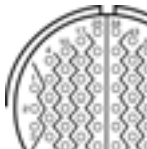
front face of pin inserts illustrated

| | | | | |
|--------------------|---|---|--|---|
| |  |  |  |  |
| Insert Arrangement | 14-37 | 14-97 | 16-2 | 16-6 |
| Service Rating | M | I | M | I |
| Number of Contacts | 37 | 8 4 | 38 1 | 6 |
| Contact Size | 22M | 20 16 | 22D 8 Twinax | 12 |
| |  |  |  |  |
| Insert Arrangement | 16-8 | 16-13 | 16-26 | 16-35 |
| Service Rating | II | I | I | M |
| Number of Contacts | 8 | 13 | 26 | 55 |
| Contact Size | 16 | 16 | 20 | 22D |
| |  |  |  |  |
| Insert Arrangement | 16-42 | 16-55 | 16-99 | 18-11 |
| Service Rating | M | M | I | II |
| Number of Contacts | 42 | 55 | 21 2 | 11 |
| Contact Size | 22 | 22M | 20 16 | 16 |
| |  |  |  |  |
| Insert Arrangement | 18-32 | 18-35 | 18-66 | 20-1 |
| Service Rating | I | M | M | M |
| Number of Contacts | 32 | 66 | 66 | 79 |
| Contact Size | 20 | 22D | 22M | 22M |

SJT

insert arrangements

front face of pin inserts illustrated

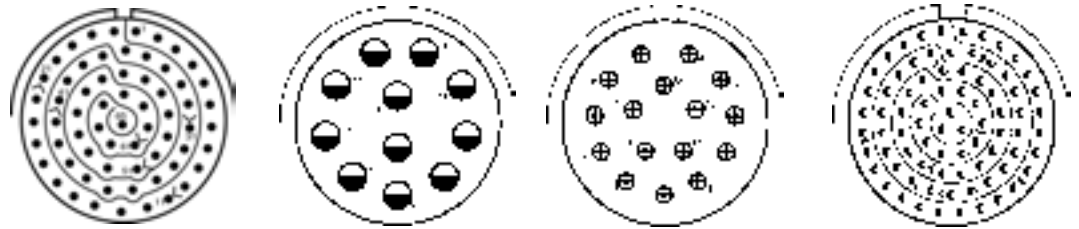

| | | | | |
|--------------------|------|-------|-------|-------|
| Insert Arrangement | 20-2 | 20-11 | 20-16 | 20-35 |
| Service Rating | M | I | II | M |
| Number of Contacts | 65 | 11 | 16 | 79 |
| Contact Size | 22 | 12 | 16 | 22D |

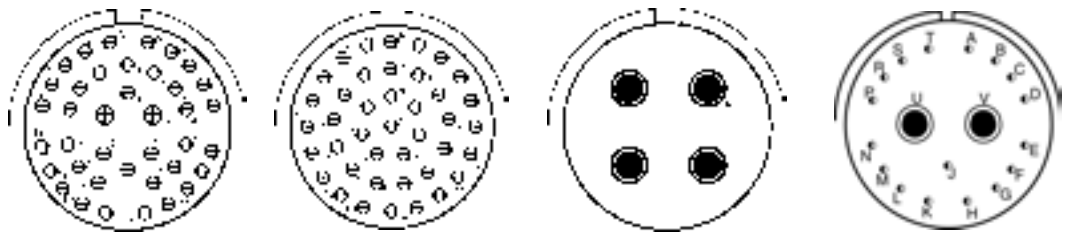

| | | | | |
|--------------------|-------|-------|----------|------------|
| Insert Arrangement | 20-39 | 20-41 | 20-75 | 20-79 |
| Service Rating | I | I | M | II |
| Number of Contacts | 37 2 | 41 | 4 | 17 2 |
| Contact Size | 20 16 | 20 | 8 Coax†† | 22 8 Coax† |

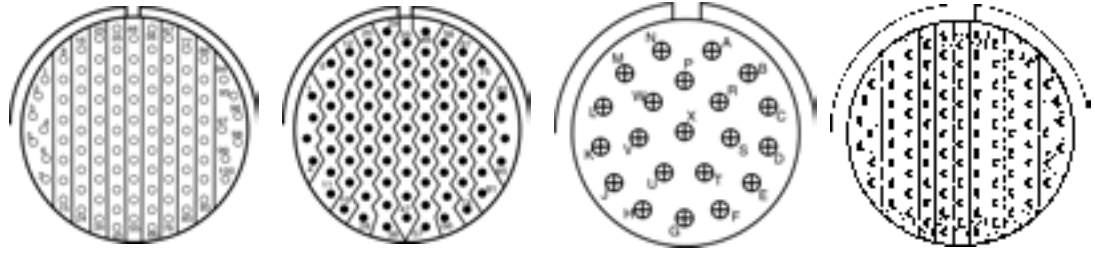

| | | | | |
|---------------------|------|------|-------|-------|
| Insert Arrangements | 22-1 | 22-2 | 22-21 | 22-35 |
| Service Rating | M | M | II | M |
| Number of Contacts | 100 | 85 | 21 | 100 |
| Contact Size | 22M | 22 | 16 | 22D |

† must be ordered separately
 †† coax contacts for RG180 or RG195 cable



SJT

insert arrangements

front face of pin inserts illustrated

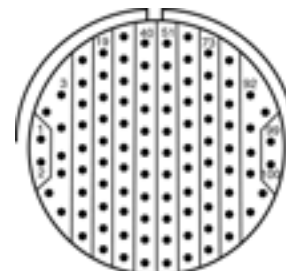
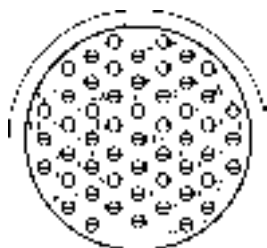

Insert Arrangement
Service Rating
Number of Contacts
Contact Size

22-53
I
53
20

24-1
M
128
22M

24-2
M
100
22

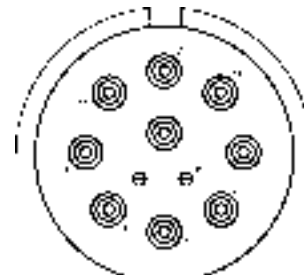
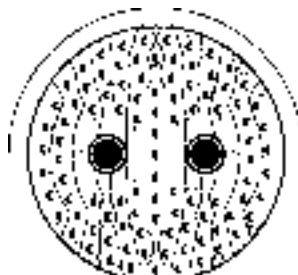
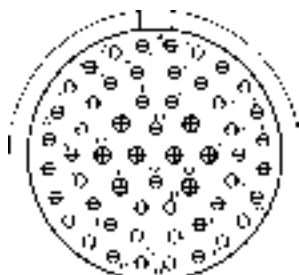

Insert Arrangement
Service Rating
Number of Contacts
Contact Size

24-4
I
48 8
20 16

24-7
M
97 2
22D 8 Twinax

24-11
N
2 9
20 10 Power

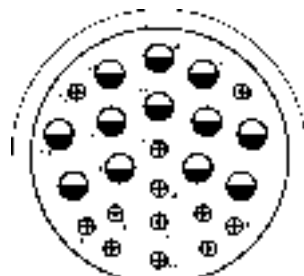
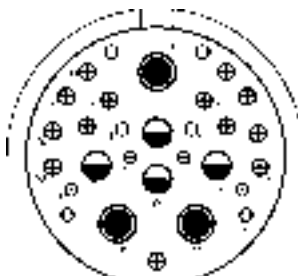
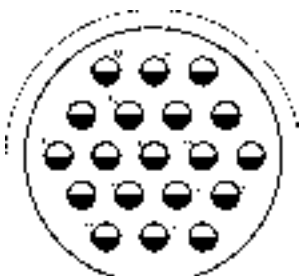

Insert Arrangement
Service Rating
Number of Contacts
Contact Size

24-19
I
19
12

24-20
N
10 13 3 4
20 16 8 Twinax 12 Coax

24-24
I
16 12
16 12

SJT

insert arrangements

front face of pin inserts illustrated

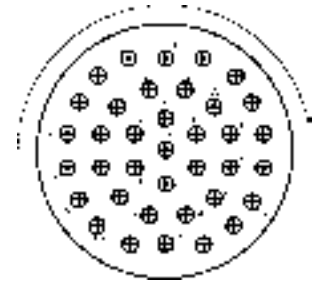
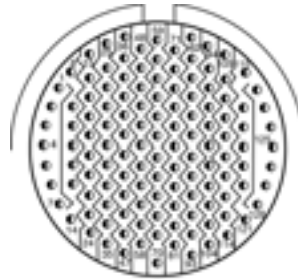
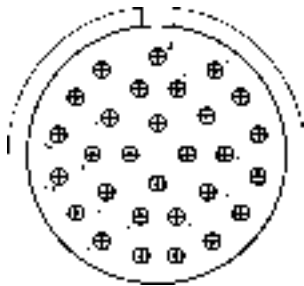

Insert Arrangement
Service Rating
Number of Contacts
Contact Size

24-29
I
29
16

24-35
M
128
22D

24-37
I
37
16

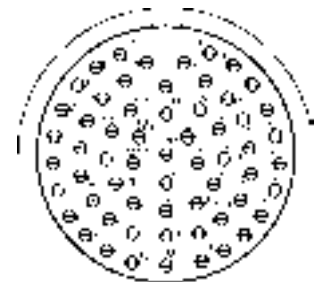
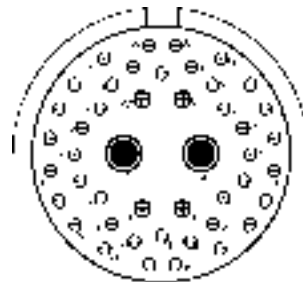
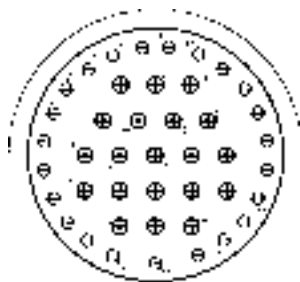

Insert Arrangement
Service Rating
Number of Contacts
Contact Size

24-43
I
23 20
20 16

24-46
I
40 4 2
20 16 8 Coax^{††}

24-61
I
61
20

^{††} coax contacts for RG180 or RG195 cable



SJT00RT- crimp wall mounting receptacle

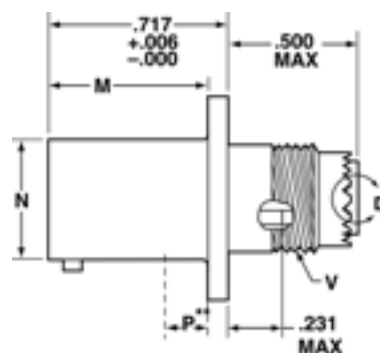
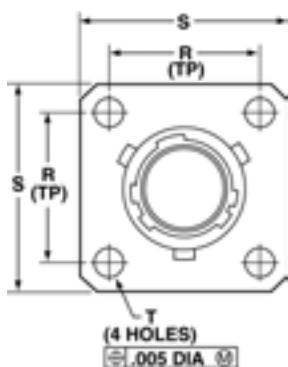

*SJT00RT-XX-XXX

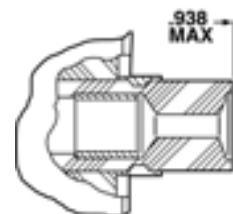

VIEW D ENLARGED
FOR COAXIAL USE ONLY

* To complete order number, see page 20

** Standard wall mount may be back panel mounted where panel thickness does not exceed these dimensions. For thicker panel applications, SJTP00RT should be used, page 10.

| Shell Size | L Max | M +.000 -.005 | R (TP) | S ±.016 | T ±.005 | V Thread Modified | | N +.001 -.005 | P** Max |
|------------|-------|---------------------|--------|------------|------------|---------------------------|------------------------|---------------------|------------|
| | | | | | | Class 2A UNEF (Plated) | Modified Major Dia. | | |
| 8 | .500 | .632 | .594 | .812 | .120 | .4375-28 | .421 – .417 | .473 | .117 |
| 10 | .500 | .632 | .719 | .938 | .120 | .5625-24 | .542 – .538 | .590 | .117 |
| 12 | .500 | .632 | .812 | 1.031 | .120 | .6875-24 | .667 – .663 | .750 | .117 |
| 14 | .500 | .632 | .906 | 1.125 | .120 | .8125-20 | .791 – .787 | .875 | .117 |
| 16 | .500 | .632 | .969 | 1.219 | .120 | .9375-20 | .916 – .912 | 1.000 | .117 |
| 18 | .500 | .632 | 1.062 | 1.312 | .120 | 1.0625-18 | 1.034 – 1.030 | 1.125 | .117 |
| 20 | .500 | .602 | 1.156 | 1.438 | .120 | 1.1875-18 | 1.158 – 1.154 | 1.250 | .087 |
| 22 | .500 | .602 | 1.250 | 1.562 | .120 | 1.3125-18 | 1.283 – 1.279 | 1.375 | .087 |
| 24 | .550 | .602 | 1.375 | 1.688 | .147 | 1.4375-18 | 1.408 – 1.404 | 1.500 | .055 |

All dimensions for reference only.

SJTP00RT – crimp wall mounting receptacle (back panel mounting)

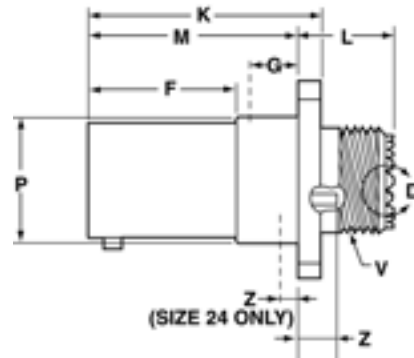
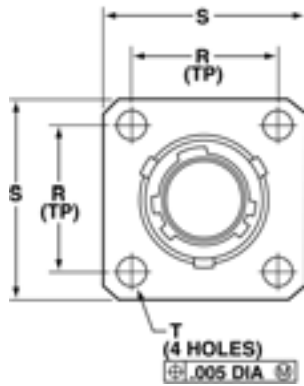

*SJTP00RT-XX-XXX

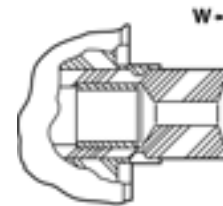

VIEW D ENLARGED
FOR COAXIAL USE ONLY

* To complete order number, see page 20

| Shell Size | F +.000 -.005 | K +.006 -.000 | L Max. | M +.000 -.005 | R (TP) | S +.011 -.010 | T ±.005 | Z ±.031 | V Thread Class 2A (Plated) UNEF | P Dia. +.001 -.005 | W Max. | G Max. |
|------------|---------------------|---------------------|-----------|---------------------|-----------|---------------------|------------|------------|---------------------------------------|-----------------------------|-----------|-----------|
| 8 | .609 | .945 | .539 | .860 | .594 | .812 | .120 | .062 | .4375-28 | .516 | .812 | .345 |
| 10 | .609 | .945 | .539 | .860 | .719 | .938 | .120 | .062 | .5625-24 | .633 | .812 | .345 |
| 12 | .609 | .945 | .539 | .860 | .812 | 1.031 | .120 | .062 | .6875-24 | .802 | .812 | .345 |
| 14 | .609 | .945 | .539 | .860 | .906 | 1.125 | .120 | .062 | .8125-20 | .927 | .812 | .345 |
| 16 | .609 | .945 | .539 | .860 | .969 | 1.219 | .120 | .062 | .9375-20 | 1.052 | .812 | .345 |
| 18 | .609 | .945 | .539 | .860 | 1.062 | 1.312 | .120 | .062 | 1.0625-18 | 1.177 | .812 | .345 |
| 20 | .609 | .945 | .539 | .860 | 1.156 | 1.438 | .120 | .062 | 1.1875-18 | 1.302 | .812 | .345 |
| 22 | .609 | .945 | .539 | .860 | 1.250 | 1.562 | .120 | .062 | 1.3125-18 | 1.427 | .812 | .345 |
| 24 | .750 | 1.085 | .493 | 1.000 | 1.375 | 1.688 | .147 | .078 | 1.4375-18 | 1.552 | .781 | .452 |

All dimensions for reference only.

SJTP02RE – crimp box mounting receptacle (back panel mounting)

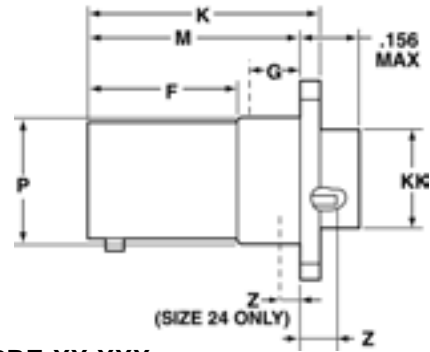
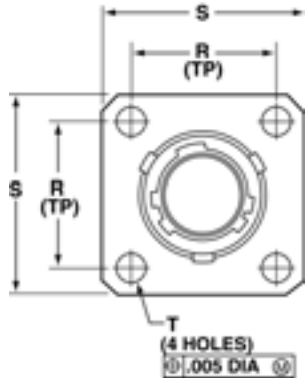

*SJTP02RE-XX-XXX

* To complete order number, see page 20

| Shell Size | F +.000 -.005 | K +.006 -.000 | M +.000 -.005 | R (TP) | S +.011 -.010 | T ±.005 | Z ±.031 | P Dia. +.001 -.005 | KK Dia. +.005 -.002 | G Max. |
|------------|---------------------|---------------------|---------------------|-----------|---------------------|------------|------------|-----------------------------|------------------------------|-----------|
| 8 | .609 | .945 | .860 | .594 | .812 | .120 | .062 | .516 | .417 | .345 |
| 10 | .609 | .945 | .860 | .719 | .938 | .120 | .062 | .633 | .538 | .345 |
| 12 | .609 | .945 | .860 | .812 | 1.031 | .120 | .062 | .802 | .663 | .345 |
| 14 | .609 | .945 | .860 | .906 | 1.125 | .120 | .062 | .927 | .787 | .345 |
| 16 | .609 | .945 | .860 | .969 | 1.219 | .120 | .062 | 1.052 | .912 | .345 |
| 18 | .609 | .945 | .860 | 1.062 | 1.312 | .120 | .062 | 1.177 | 1.030 | .345 |
| 20 | .609 | .945 | .860 | 1.156 | 1.438 | .120 | .062 | 1.302 | 1.154 | .345 |
| 22 | .609 | .945 | .860 | 1.250 | 1.562 | .120 | .062 | 1.427 | 1.279 | .345 |
| 24 | .750 | 1.085 | 1.000 | 1.375 | 1.688 | .147 | .078 | 1.552 | 1.404 | .452 |

All dimensions for reference only.

SJT06RT/SJTG06RT – crimp straight plug/straight plug (with grounding fingers)

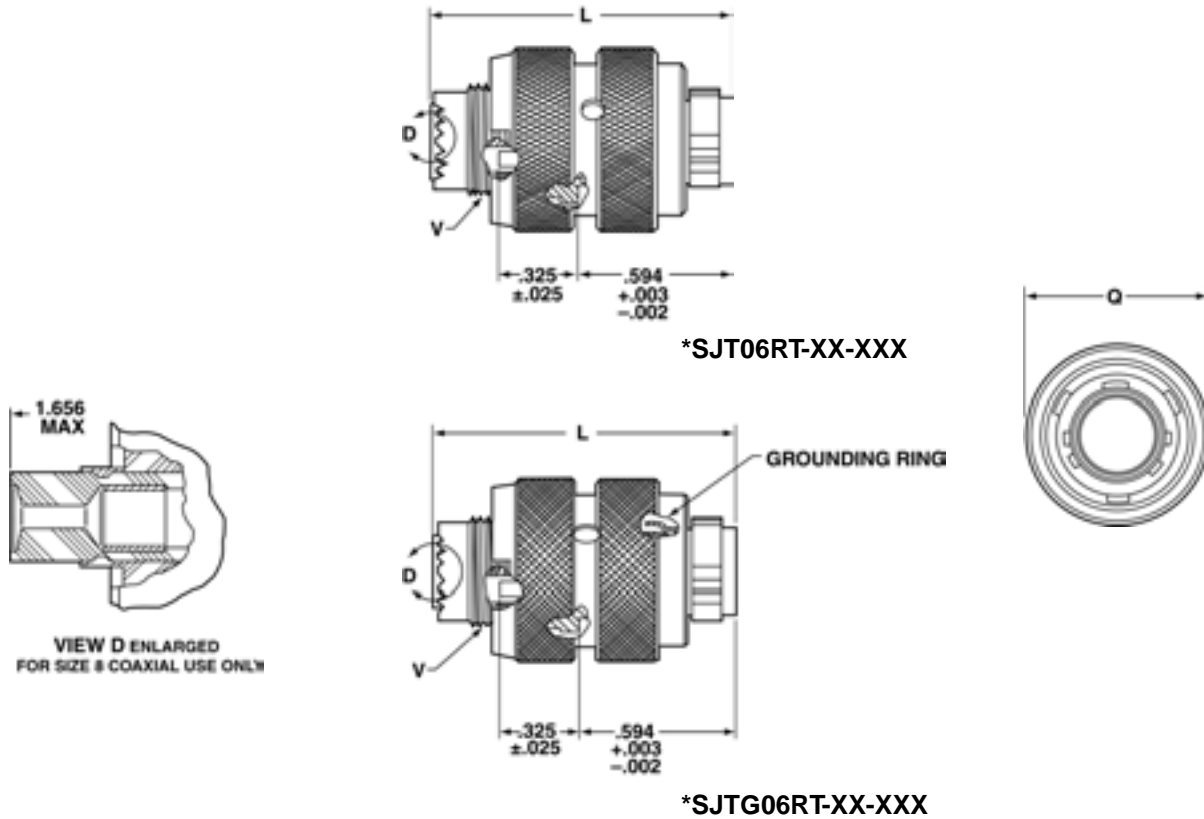

* To complete order, see page 20

| Shell Size | L Max | Q Dia. Max. | V Thread | |
|------------|-------|-------------|------------------------|---------------------|
| | | | Class 2A UNEF (Plated) | Modified Major Dia. |
| 8 | 1.219 | .734 | .4375-28 | .421 – .417 |
| 10 | 1.219 | .844 | .5625-24 | .542 – .538 |
| 12 | 1.219 | 1.016 | .6875-24 | .667 – .663 |
| 14 | 1.219 | 1.141 | .8125-20 | .791 – .787 |
| 16 | 1.219 | 1.265 | .9375-20 | .916 – .912 |
| 18 | 1.219 | 1.391 | 1.0625-18 | 1.034 – 1.030 |
| 20 | 1.219 | 1.500 | 1.1875-18 | 1.158 – 1.154 |
| 22 | 1.219 | 1.625 | 1.3125-18 | 1.283 – 1.279 |
| 24 | 1.258 | 1.750 | 1.4375-18 | 1.408 – 1.404 |

All dimensions for reference only.

SJT07RT – crimp jam nut receptacle

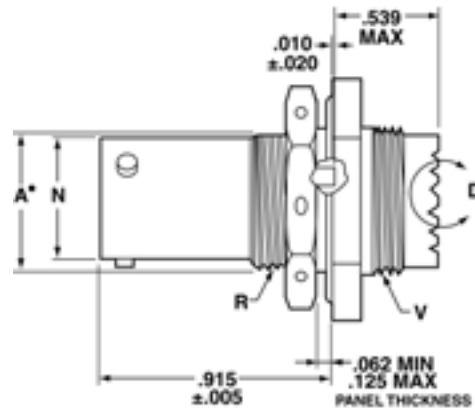
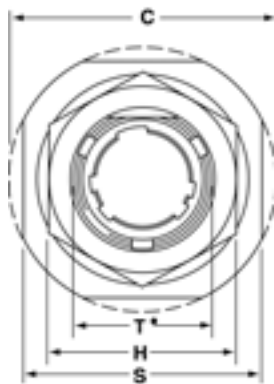

*SJT07RT-XX-XXX

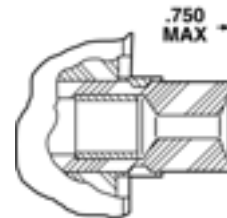

VIEW D ENLARGED
FOR SIZE 8 COAXIAL USE ONLY

- "D" shaped panel cut-out dimensions
- * To complete order number, see page 20
- ** Oversize threads. Check accessory threads before ordering

| Shell Size | A* +.000 -.010 | H Hex +.017 -.016 | S ±.016 | V Thread Class 2A UNEF (Plated) | R Thread Class 2A UNEF (Plated) | N +.001 -.005 | C Max. | T* +.010 -.000 |
|------------|----------------------|----------------------------|------------|---------------------------------------|---------------------------------------|---------------------|-----------|----------------------|
| 8 | .542 | .750 | .938 | .5625-24 | .5625-24 | .473 | 1.078 | .572 |
| 10 | .669 | .875 | 1.062 | .6875-24 | .6875-24 | .590 | 1.203 | .697 |
| 12 | .830 | 1.062 | 1.250 | .8125-20 | .8750-20 | .750 | 1.391 | .884 |
| 14 | .955 | 1.188 | 1.375 | .9375-20 | 1.0000-20 | .875 | 1.515 | 1.007 |
| 16 | 1.084 | 1.312 | 1.500 | 1.0625-18 | 1.1250-18 | 1.000 | 1.641 | 1.134 |
| 18 | 1.208 | 1.438 | 1.625 | 1.1875-18 | 1.2500-18 | 1.125 | 1.766 | 1.259 |
| 20 | 1.333 | 1.562 | 1.812 | 1.3125-18 | 1.3750-18 | 1.250 | 1.953 | 1.384 |
| 22 | 1.459 | 1.688 | 1.938 | 1.4375-18 | 1.5000-18 | 1.375 | 2.078 | 1.507 |
| 24 | 1.580 | 1.812 | 2.062 | 1.4375-18 | 1.6250-18 | 1.500 | 2.203 | 1.634 |

All dimensions for reference only.

SJTIY – hermetic solder mounting receptacle

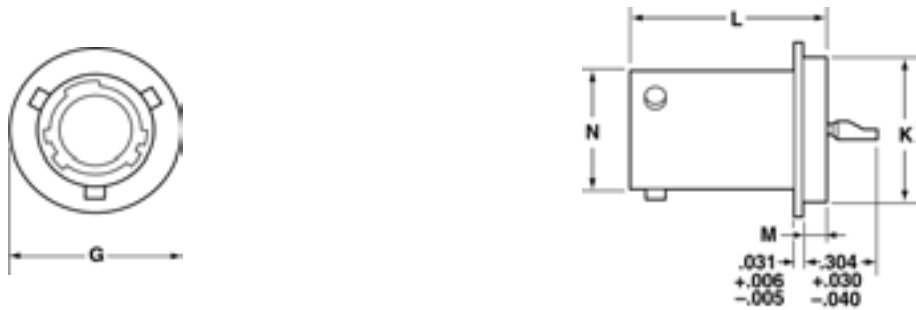

*SJTIY-XX-XXX

* To complete order, see page 20

| Shell Size | L +.011 -.000 | M +.006 -.005 | G Dia. +.011 -.010 | K Dia. +.001 -.005 | N +.001 -.005 |
|------------|---------------------|---------------------|--------------------------|--------------------------|---------------------|
| 8 | .789 | .125 | .687 | .562 | .473 |
| 10 | .789 | .125 | .797 | .672 | .590 |
| 12 | .789 | .125 | .906 | .781 | .750 |
| 14 | .789 | .125 | 1.031 | .906 | .875 |
| 16 | .789 | .125 | 1.156 | 1.031 | 1.000 |
| 18 | .789 | .125 | 1.281 | 1.156 | 1.125 |
| 20 | .789 | .125 | 1.375 | 1.250 | 1.250 |
| 22 | .821 | .156 | 1.500 | 1.375 | 1.375 |
| 24 | .821 | .156 | 1.625 | 1.500 | 1.500 |

All dimensions for reference only.

SJT07Y – hermetic jam nut receptacle

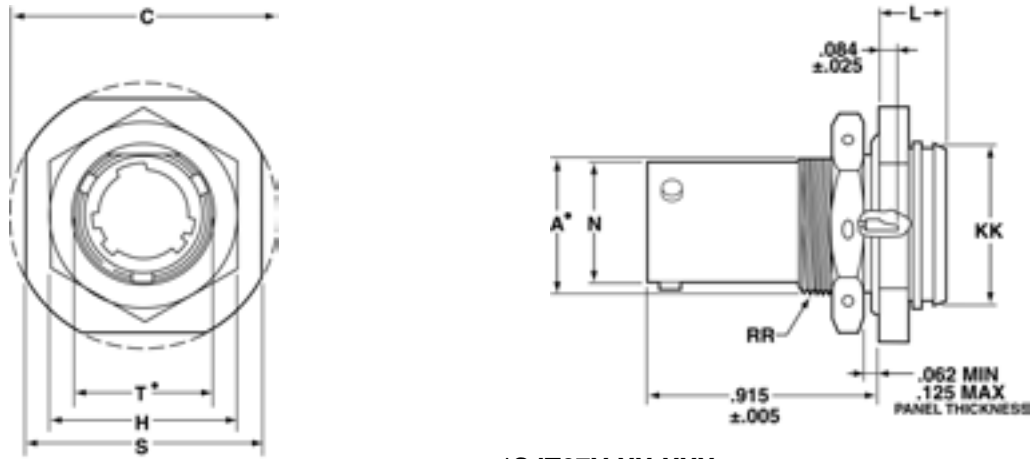

*SJT07Y-XX-XXX

- "D" shaped panel cut-out dimensions
- * To complete order number, see page 20

| Shell Size | N +.001 -.005 | C Max. | A [•] +.000 -.010 | L Max. | H Hex +.017 -.016 | S ±.016 | KK +.011 -.000 | RR Thread Class 2A UNEF (Plated) | T [•] +.010 -.000 |
|------------|---------------------|-----------|----------------------------------|-----------|----------------------------|------------|----------------------|---|----------------------------------|
| 8 | .473 | 1.078 | .542 | .297 | .750 | .938 | .642 | .5625-24 | .572 |
| 10 | .590 | 1.203 | .669 | .297 | .875 | 1.062 | .766 | .6875-24 | .697 |
| 12 | .750 | 1.391 | .830 | .297 | 1.062 | 1.250 | .892 | .8750-20 | .884 |
| 14 | .875 | 1.515 | .955 | .297 | 1.188 | 1.375 | 1.018 | 1.0000-20 | 1.007 |
| 16 | 1.000 | 1.641 | 1.084 | .297 | 1.312 | 1.500 | 1.142 | 1.1250-18 | 1.134 |
| 18 | 1.125 | 1.766 | 1.208 | .328 | 1.438 | 1.625 | 1.268 | 1.2500-18 | 1.259 |
| 20 | 1.250 | 1.953 | 1.333 | .328 | 1.562 | 1.812 | 1.392 | 1.3750-18 | 1.384 |
| 22 | 1.375 | 2.078 | 1.459 | .328 | 1.688 | 1.938 | 1.518 | 1.5000-18 | 1.507 |
| 24 | 1.500 | 2.203 | 1.580 | .328 | 1.812 | 2.062 | 1.642 | 1.6250-18 | 1.634 |

All dimensions for reference only.

SJT

contacts, sealing plugs, plastic protection caps

CONTACTS & SEALING PLUGS

| Contact Size | SJT Pins | SJT Sockets | Sealing Plugs |
|--------------|---------------|----------------------------------|---------------------|
| 8 (Coax) | 21-33102-21** | 21-33101-21** | 10-482099-8 |
| 8 (Twinax) | 21-33190-529† | 21-33191-530† | 10-482099-8 |
| 10 (Power) | 10-251415-105 | 10-407035-105 | Not Available |
| 12 | 10-251415-12H | 10-407035-125 | 10-405996-12 Yellow |
| 16 | 10-251415-165 | 10-407035-165 | 10-405996-16 Blue |
| 20 | 10-251415-205 | 10-407035-205 10-497403-205†† | 10-405996-20 Red |
| 22* | 10-251415-225 | 10-407035-225 | 10-405996-22 Black |
| 22M* | 10-251415-235 | 10-407035-235 | 10-405996-22 Black |
| 22D | 10-251415-725 | 10-407035-725 | 10-405996-22 Black |

Above part numbers include standard finish designation – gold plating over suitable underplate in accordance with MIL-C-39029. For other finish variations, consult Amphenol, Sidney, NY.

* Inactive for new design.

** 21-33102-21 and 21-33101-21 are for use with RG180B/U and RG195A/U cable. For other size 8 coax or optional sizes 12 and 16 coax contacts available for use in SJT connectors, see catalog 12-130 or consult Amphenol, Sidney, NY.

† 21-33190-529 and 21-33191-530 are for use with M17/176-00002 cable.

†† Optional design – see slash sheet MS39029.

For other contact options available for use in SJT connectors, (wire-wrap, thermocouple, fiber optic) consult Amphenol, Sidney, NY.

PLASTIC PROTECTION CAPS

| Shell Size | Plug | Receptacle |
|------------|-------------|--------------|
| 8 | 10-70500-10 | 10-70506-10S |
| 10 | 10-70500-14 | 10-70506-12 |
| 12 | 10-70500-16 | 10-70506-14 |
| 14 | 10-70500-18 | 10-70506-16 |
| 16 | 10-70500-20 | 10-70506-18 |
| 18 | 10-70500-22 | 10-70506-20 |
| 20 | 10-70500-24 | 10-70506-22 |
| 22 | 10-70524-1 | 10-70506-24 |
| 24 | 10-70506-28 | 10-70524-1 |

SJT – accessories

plug protection cap/receptacle protection cap

PLUG PROTECTION CAP

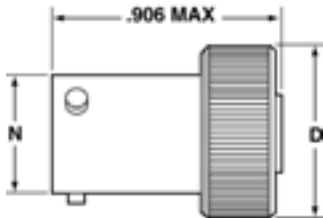

*10-476801-XXX

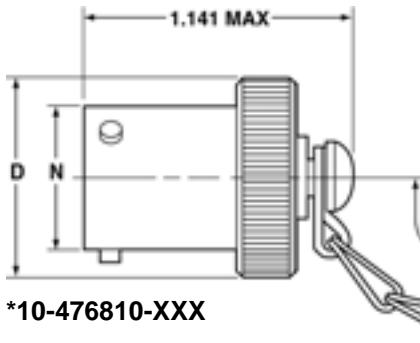

*10-476810-XXX

RECEPTACLE PROTECTION CAP

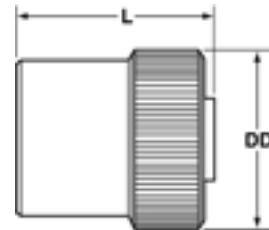

*10-325943-XXX

*To complete order number, add shell size and suffix number. For example, shell size 10 with bright cadmium plated nickel base, 10-476810-107.

| Plug Shell Size | D Dia. Max. | N Dia. +.001 - .005 |
|-----------------|-------------|---------------------|
| 8 | .688 | .473 |
| 10 | .812 | .590 |
| 12 | .969 | .750 |
| 14 | 1.094 | .875 |
| 16 | 1.219 | 1.000 |
| 18 | 1.344 | 1.125 |
| 20 | 1.469 | 1.250 |
| 22 | 1.594 | 1.375 |
| 24 | 1.719 | 1.500 |

*To complete order number, add shell size and suffix number. For example, shell size 10 with bright cadmium plated nickel base, 10-325943-107.

| Receptacle Shell Size | DD Dia. Max. | L Max. |
|-----------------------|--------------|--------|
| 8 | .734 | .828 |
| 10 | .844 | .828 |
| 12 | 1.016 | .828 |
| 14 | 1.141 | .828 |
| 16 | 1.265 | .828 |
| 18 | 1.391 | .828 |
| 20 | 1.500 | .828 |
| 22 | 1.625 | .828 |
| 24 | 1.750 | .859 |

Finish
 Bright Cadmium Plated Nickel Base
 Anodic Coating (Alumilite)
 Chromate Treated (Iridite 14-2)
 Olive Drab Cadmium Plate Nickel Base
 Electroless Nickel Coating

Suffix
 XX7
 XX5
 XX0
 XX9
 XXG

All dimensions for reference only

SJT – accessories

dummy receptacle, cable clamp

DUMMY RECEPTACLE

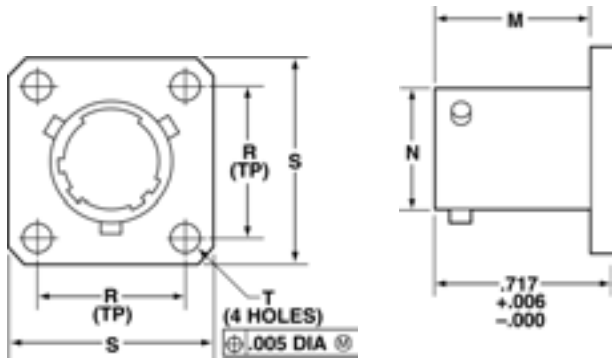

*10-476807-XXX

| Finish | Suffix |
|--------------------------------------|--------|
| Bright Cadmium Plated Nickel Base | XX7 |
| Anodic Coating (Alumilite) | XX5 |
| Chromate Treated (Iridite 14-2) | XX0 |
| Olive Drab Cadmium Plate Nickel Base | XX9 |
| Electroless Nickel Coating | XXG |

* To complete order number, add shell size and suffix number. For example, shell size 10 with bright cadmium plated nickel base, 10-476807-107.

| Dummy Receptacle Shell Size | D Dia. Max. | L Max. |
|-----------------------------|-------------|--------|
| 8 | .734 | .828 |
| 10 | .844 | .828 |
| 12 | 1.016 | .828 |
| 14 | 1.141 | .828 |
| 16 | 1.265 | .828 |
| 18 | 1.391 | .828 |
| 20 | 1.500 | .828 |
| 22 | 1.625 | .828 |
| 24 | 1.750 | .859 |

All dimensions for reference only

CABLE CLAMP

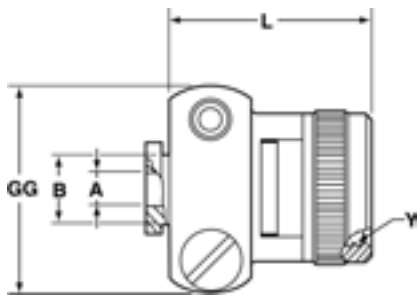

*10-476808-XXX

| Finish | Suffix |
|--------------------------------------|--------|
| Bright Cadmium Plated Nickel Base | XX7 |
| Anodic Coating (Alumilite) | XX5 |
| Chromate Treated (Iridite 14-2) | XX0 |
| Olive Drab Cadmium Plate Nickel Base | XX9 |
| Electroless Nickel Coating | XXG |

* To complete order number, add shell size and suffix number. For example, shell size 10 with bright cadmium plated nickel base, 10-476808-107.

| Cable Clamp Shell Size | A Dia. +.010 - .025 | B Dia. +.000 - .011 | L Max. | Y Thread Class 2B UNEF (Plated) | GG Max. |
|------------------------|---------------------|---------------------|--------|---------------------------------|---------|
| 8 | .125 | .250 | .922 | .4375-28 | .775 |
| 10 | .188 | .312 | .922 | .5625-24 | .837 |
| 12 | .312 | .438 | .922 | .6875-24 | .963 |
| 14 | .375 | .562 | 1.172 | .8125-20 | 1.087 |
| 16 | .500 | .625 | 1.172 | .9375-20 | 1.150 |
| 18 | .625 | .750 | 1.172 | 1.0625-18 | 1.400 |
| 20 | .625 | .750 | 1.172 | 1.1875-18 | 1.400 |
| 22 | .750 | .938 | 1.297 | 1.3125-18 | 1.587 |
| 24 | .800 | 1.000 | 1.297 | 1.4375-18 | 1.681 |

All dimensions for reference only

SJT

application tools

The following data includes information pertaining to the application tools which have been established for crimping, inserting, and removing contacts incorporated in the SJT.

For additional information on coaxial contact tools, see catalog 12-130.

All crimping tools included are the "full cycling" type and when used as specified in the installation instructions (L-624) covering the SJT series connectors, will provide reliable crimped wire to contact terminations. There is a possibility of additional crimping tools other than those included being available at present or in the future for this specific application.

CRIMPING TOOLS

| Contact Size/Type | Crimping Tool | Turret Die or Positioner |
|--|---|---|
| 12 Pin and Socket | M22520/1-01 | M22520/1-04 |
| 16 Pin and Socket | M22520/1-01 M22520/7-01 | M22520/1-04 M22520/7-04 |
| 20 Pin and Socket | M22520/1-01 M22520/2-01 M22520/7-01 | M22520/1-04 M22520/2-10 M22520/7-08 |
| 22, 22D, 22M Pin | M22520/2-01 M22520/7-01 | M22520/2-09 M22520/7-07 |
| 22, 22D, 22M Socket (LJT-R) | M22520/2-01 M22520/7-01 | M22520/2-07 M22520/7-05 |
| 8 Twinax Center Pin and Socket | M22520/2-01 | M22520/2-37 |
| 8 Twinax Intermediate Outer Pin & Socket | M22520/5-01 | M22520/5-200 |

| Contact Size/Type | Crimping Tool | Turret Die or Positioner |
|---------------------------------|---------------|-------------------------------|
| 8 Coaxial Inner Pin and Socket | M22520/2-01 | M22520/2-31 |
| 8 Coaxial Outer Pin and Socket | M22520/5-01 | M22520/5-05 Die Closure B |
| | M22520/5-01 | M22520/5-41 Die Closure B |
| | M22520/10-01 | M22520/10-07 Die Closure B |
| 16 Coaxial Inner Pin and Socket | M22520/2-01 | M22520/2-35 |
| 16 Coaxial Outer Pin and Socket | M22520/4-01 | M22520/4-02 |
| 12 Coaxial Inner Pin and Socket | M22520/2-01 | M22520/2-34 |
| 12 Coaxial Outer Pin and Socket | M22520/31-01 | M22520/31-02 |
| 10 (Power) | *** | *** |

Where 2 or 3 tools are listed for a contact size, only one tool and its die or positioner are required to crimp the contact. The above crimping tools and positioners are available from the approved tool manufacturer.

INSERTION TOOLS

| Use With Contact Size | Plastic Tools | | Metal Tools | | | |
|-----------------------|----------------|----------------|----------------|-------------------------|---------------------------------------|--------|
| | MS Part Number | Color | Angle Type | | Straight Type Proprietary Part Number | Color |
| | | | MS Part Number | Proprietary Part Number | | |
| 10 (Power) | M81969/14-05* | Gray/(White) | M81969/8-11 | † | † | Green |
| 12 | M81969/14-04* | Yellow/(White) | M81969/8-09 | 11-8674-12 | 11-8794-12 | Yellow |
| 16 | M81969/14-03* | Blue/(White) | M81969/8-07 | 11-8674-16 | 11-8794-16 | Blue |
| 20 | M81969/14-10* | Red/(Orange) | M81969/8-05 | 11-8674-20 | 11-8794-20 | Red |
| 22 | M81969/14-09* | Brown/(White) | M81969/8-03 | 11-8674-22 | 11-8794-22 | Brown |
| 22D, 22M | M81969/14-01* | Green/(White) | M81969/8-01 | 11-8674-24 | 11-8794-22 | Brown |
| 8 Coaxial | None Required | | | | | |
| 8 Twinax | None | | M81969/46-06** | None | | Red |

REMOVAL TOOLS

| Use With Contact Size | Plastic Tools | | Metal Tools | | | | |
|-----------------------|----------------|----------------|--|----------------|-------------------------|---------------------------------------|--------------|
| | MS Part Number | Color Code | For Unwired Contacts Proprietary Part Number | Angle Type | | Straight Type Proprietary Part Number | Color Code |
| | | | | MS Part Number | Proprietary Part Number | | |
| 10 (Power) | M81969/14-05* | (Green)/White | † | M81969/8-12 | † | † | Green/White |
| 12 | M81969/14-04* | (Yellow)/White | 11-10050-11 | M81969/8-10 | 11-8675-12 | 11-8795-12 | Yellow/White |
| 16 | M81969/14-03* | (Blue)/White | 11-10050-10 | M81969/8-08 | 11-8675-16 | 11-8795-16 | Blue/White |
| 20 | M81969/14-10* | Orange | 11-10050-9 | M81969/8-06 | 11-8675-20 | 11-8795-20 | Red/White |
| 22 | M81969/14-09* | (Brown)/White | 11-10050-8 | M81969/8-04 | 11-8675-22 | 11-8795-22 | Brown/White |
| 22D, 22M | M81969/14-01* | (Green)/White | 11-10050-7 | M81969/8-02 | 11-8675-24 | 11-8795-24 | Green/White |
| 8 Coaxial | M81969/14-12 | Green | None | None | 11-9170 | DRK264-8†† | N/A |
| 8 Twinax | M81969/14-12 | Green | None | M81969/46-12** | 11-9170 | N/A | N/A |

The M81969/8, 11-8674, 11-8675, and 11-8794 metal contact insertion and removal tools will accommodate wires having the maximum outside diameter as follows: Contact size 12--155, 16--109, 20--077, 22, 22D, 22M--050. When wire diameters exceed those specified, the plastic tools must be used.

* Double ended insertion/removal tool.

** Twinax insertion tools are available only in a straight type, metal version.

*** For size 10 power contact application tools, consult Amphenol, Sidney, NY.

† To be determined.

†† Contact Daniels Manufacturing Co. for availability.

SJT

how to order

PART NUMBER

To more easily illustrate ordering procedure, part number SJT00RT-18-66PA() is shown as follows:

| | | | | | | | | | |
|------------|-----------|-----------|---|-----------|---|-----------|----------|----------|------------|
| <u>SJT</u> | <u>00</u> | <u>RT</u> | - | <u>18</u> | - | <u>66</u> | <u>P</u> | <u>A</u> | <u>()</u> |
| 1 | 2 | 3 | | 4 | | 5 | 6 | 7 | 8 |

See code below:

1. Connector Type:
 - SJT designates standard scoop-proof Junior Tri-Lock Connector
 - SJTS designates high temperature connector
 - SJTG designates plug with grounding fingers
 - SJTP designates back panel mounted
2. Shell Style:
 - 00 designates wall mount receptacle
 - 06 designates straight plug
 - 07 designates jam nut receptacle
 - I designates solder mount receptacle – hermetic
3. Service Class:
 - “Y” for hermetic applications. . . fused compression glass sealed inserts. Leakage rate less than 1.0×10^{-6} cc/sec. at 15 psi differential; with interfacial seal.
 - “RT” for environmental applications – supplied without rear accessories. Design provides serrations on rear threads of shells with moisture sealing pilot for back shells.
 - For additional information defining complete description of service class, consult Amphenol, Sidney, NY.
4. SJT shell sizes available from 8 through 24.
5. 18-66 designates insert arrangement. Refer to pages 3 through 8 for insert pattern availability.
6. “P” designates pin contacts; “S” for socket contacts.
7. “A” designates alternate keying. Other basic rotations are “B”, “C” and “D”. No letter required for normal (no rotation) position. (see page 2)
8. Finish variation suffix. (Page 2).

X-ON Electronics

Largest Supplier of Electrical and Electronic Components

Click to view similar products for [Circular DIN Connectors](#) category:

Click to view products by [Amphenol](#) manufacturer:

Other Similar products are found below :

[CTV06RQF-25-8SA-LC](#) [CTV06RQF-25-8S-LC](#) [CTV06RQW-25-8SB-LC](#) [CTV06RW-25-20P](#) [CTV06RW-25-20PA](#) [CTV06RW-25-20PB](#)
[CTV06RW-25-20PE-LC](#) [CTV06RW-25-20SB](#) [CTV06RW-25-20SE](#) [CTV07RW-17-8S\(506\)](#) [CTVP00RW-19-32S\(506\)](#) [CTVP00RW-9-35S\(506\)](#) [M83723/71R20416](#) [M83723/71R22196](#) [M83723/71W2039N](#) [M83723/71W24196](#) [M83723/71W2419N](#) [M83723/72A1404N-LC](#)
[M83723/72R1203N](#) [M83723/72W20418](#) [M83723/72W22126](#) [M83723/72W22556](#) [M83723/72W2419N](#) [M83723/72W2461N](#)
[M83723/73R2028N](#) [M83723/73R2039N](#) [M83723/73W1412N](#) [M83723/73W2039N](#) [M83723/74R1624N](#) [M83723/74R1808N](#)
[M83723/74R2212N](#) [M83723/74W1203N](#) [M83723/74W1412N](#) [M83723/74W20416](#) [M83723/74W2041N](#) [M83723/75R10058](#)
[M83723/75W2232N](#) [M83723/76R14157](#) [M83723/76R20256](#) [M83723/76W1808N](#) [M83723/76W2016N](#) [M83723/76W2461N](#)
[M83723/77W2016N](#) [M83723/78R22327](#) [M83723/78W2212N](#) [M83723/78W22556](#) [M85049/50-5F](#) [D38999/20FF11AC](#) [D38999/20FJ20BB](#)
[D38999/20FJ20SC](#)