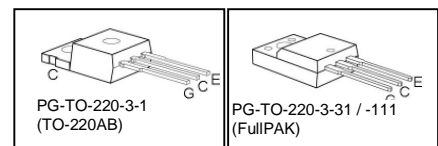
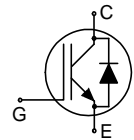


## Fast IGBT in NPT-technology with soft, fast recovery anti-parallel Emitter Controlled Diode

- 75% lower  $E_{off}$  compared to previous generation combined with low conduction losses
- Short circuit withstand time – 10  $\mu$ s
- Designed for: Motor controls, Inverter
- NPT-Technology for 600V applications offers:
  - very tight parameter distribution
  - high ruggedness, temperature stable behaviour
  - parallel switching capability
- Very soft, fast recovery anti-parallel Emitter Controlled Diode
- Isolated TO-220, 2.5kV, 60s
- Pb-free lead plating; RoHS compliant
- Qualified according to JEDEC<sup>1</sup> for target applications
- Complete product spectrum and PSpice Models : <http://www.infineon.com/igbt/>



Type	$V_{CE}$	$I_C$	$V_{CE(sat)}$	$T_j$	Marking	Package
SKP06N60	600V	6A	2.3V	150°C	K06N60	PG-TO-220-3-1
SKA06N60	600V	5A	2.3V	150°C	K06N60	PG-TO-220-3-31 / -111

<sup>1</sup> J-STD-020 and JEDEC-022

**Maximum Ratings**

Parameter	Symbol	Value		Unit
		SKP06N60	SKA06N60	
Collector-emitter voltage	$V_{CE}$	600	600	V
DC collector current	$I_C$			A
$T_C = 25^\circ\text{C}$		12	9	
$T_C = 100^\circ\text{C}$		6.9	5.0	
Pulsed collector current, $t_p$ limited by $T_{jmax}$	$I_{Cpuls}$	24	24	
Turn off safe operating area $V_{CE} \leq 600\text{V}$ , $T_j \leq 150^\circ\text{C}$	-	24	24	
Diode forward current	$I_F$			
$T_C = 25^\circ\text{C}$		12	12	
$T_C = 100^\circ\text{C}$		6	6	
Diode pulsed current, $t_p$ limited by $T_{jmax}$	$I_{Fpuls}$	24	24	
Gate-emitter voltage	$V_{GE}$	$\pm 20$	$\pm 20$	V
Short circuit withstand time <sup>2</sup>	$t_{SC}$			$\mu\text{s}$
$V_{GE} = 15\text{V}$ , $V_{CC} \leq 600\text{V}$ , $T_j \leq 150^\circ\text{C}$		10	10	
Power dissipation	$P_{tot}$			W
$T_C = 25^\circ\text{C}$		68	32	
Mounting Torque, Screw: M2.5 (Fullpak), M3 (TO220) <sup>3</sup>	$M$	0.6	0.5	Nm
Operating junction and storage temperature	$T_j, T_{stg}$	-55...+150	-55...+150	$^\circ\text{C}$
Soldering temperature	$T_s$	260	260	$^\circ\text{C}$
wavesoldering, 1.6 mm (0.063 in.) from case for 10s				

<sup>2</sup> Allowed number of short circuits: <1000; time between short circuits: >1s.

<sup>3</sup> Maximum mounting processes: 3

### Thermal Resistance

Parameter	Symbol	Conditions	Max. Value		Unit
			SKP06N60	SKA06N60	
<b>Characteristic</b>					
IGBT thermal resistance, junction – case	$R_{thJC}$		1.85	3.9	K/W
Diode thermal resistance, junction – case	$R_{thJCD}$		3.5	5.0	
Thermal resistance, junction – ambient	$R_{thJA}$	PG-TO-220-3-1 PG-TO220-3-31 /-111	62	65	

### Electrical Characteristic, at $T_j = 25^\circ\text{C}$ , unless otherwise specified

Parameter	Symbol	Conditions	Value			Unit
			min.	Typ.	max.	

### Static Characteristic

Collector-emitter breakdown voltage	$V_{(BR)CES}$	$V_{GE}=0V, I_C=500\mu A$	600	-	-	V
Collector-emitter saturation voltage	$V_{CE(sat)}$	$V_{GE} = 15V, I_C=6A$ $T_j=25^\circ\text{C}$ $T_j=150^\circ\text{C}$	1.7 -	2.0 2.3	2.4 2.8	
Diode forward voltage	$V_F$	$V_{GE}=0V, I_F=6A$ $T_j=25^\circ\text{C}$ $T_j=150^\circ\text{C}$	1.2 -	1.4 1.25	1.8 1.65	
Gate-emitter threshold voltage	$V_{GE(th)}$	$I_C=250\mu A, V_{CE}=V_{GE}$	3	4	5	
Zero gate voltage collector current	$I_{CES}$	$V_{CE}=600V, V_{GE}=0V$ $T_j=25^\circ\text{C}$ $T_j=150^\circ\text{C}$	- -	- -	20 700	$\mu A$
Gate-emitter leakage current	$I_{GES}$	$V_{CE}=0V, V_{GE}=20V$	-	-	100	nA
Transconductance	$g_{fs}$	$V_{CE}=20V, I_C=6A$	-	4.2	-	S

### Dynamic Characteristic

Input capacitance	$C_{iss}$	$V_{CE}=25V,$ $V_{GE}=0V,$ $f=1\text{MHz}$	-	350	420	pF
Output capacitance	$C_{oss}$		-	38	46	
Reverse transfer capacitance	$C_{riss}$		-	23	28	
Gate charge	$Q_{Gate}$	$V_{CC}=480V, I_C=6A$ $V_{GE}=15V$	-	32	42	nC
Internal emitter inductance measured 5mm (0.197 in.) from case	$L_E$		-	7	-	nH
Short circuit collector current <sup>2)</sup>	$I_{C(SC)}$	$V_{GE}=15V, t_{SC}\leq 10\mu s$ $V_{CC}\leq 600V,$ $T_j\leq 150^\circ\text{C}$	-	60	-	A

<sup>2)</sup> Allowed number of short circuits: <1000; time between short circuits: >1s.

**Switching Characteristic, Inductive Load, at  $T_j=25^\circ\text{C}$**

Parameter	Symbol	Conditions	Value			Unit
			min.	typ.	max.	
<b>IGBT Characteristic</b>						
Turn-on delay time	$t_{d(on)}$	$T_j=25^\circ\text{C}$ , $V_{CC}=400\text{V}$ , $I_C=6\text{A}$ , $V_{GE}=0/15\text{V}$ , $R_G=50\Omega$ , $L_{\sigma}^{(1)}=180\text{nH}$ , $C_{\sigma}^{(1)}=250\text{pF}$ Energy losses include "tail" and diode reverse recovery.	-	25	30	ns
Rise time	$t_r$		-	18	22	
Turn-off delay time	$t_{d(off)}$		-	220	264	
Fall time	$t_f$		-	54	65	
Turn-on energy	$E_{on}$		-	0.110	0.127	mJ
Turn-off energy	$E_{off}$		-	0.105	0.137	
Total switching energy	$E_{ts}$		-	0.215	0.263	

**Anti-Parallel Diode Characteristic**

Diode reverse recovery time	$t_{rr}$	$T_j=25^\circ\text{C}$ , $V_R=200\text{V}$ , $I_F=6\text{A}$ , $di_F/dt=200\text{A}/\mu\text{s}$	-	200	-	ns
	$t_S$		-	17	-	
	$t_F$		-	183	-	
Diode reverse recovery charge	$Q_{rr}$		-	200	-	nC
Diode peak reverse recovery current	$I_{rrm}$		-	2.8	-	A
Diode peak rate of fall of reverse recovery current during $t_b$	$di_{rr}/dt$	-	180	-	A/ $\mu\text{s}$	

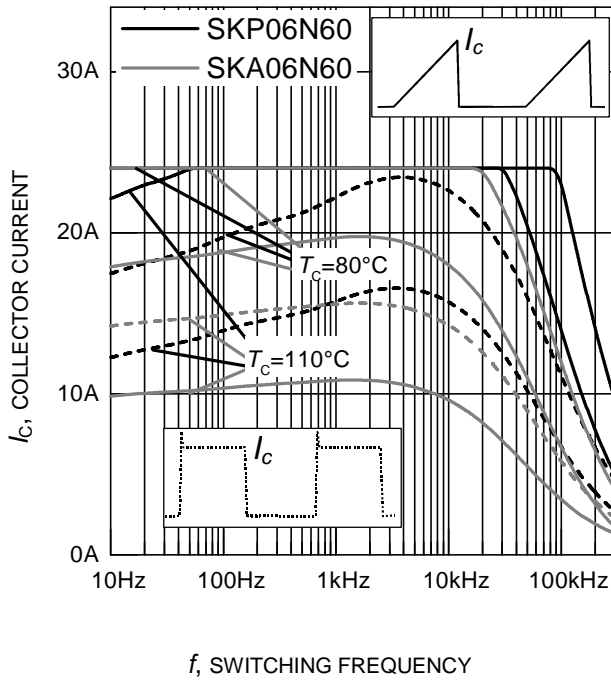
**Switching Characteristic, Inductive Load, at  $T_j=150^\circ\text{C}$**

Parameter	Symbol	Conditions	Value			Unit
			min.	typ.	max.	
<b>IGBT Characteristic</b>						
Turn-on delay time	$t_{d(on)}$	$T_j=150^\circ\text{C}$ $V_{CC}=400\text{V}$ , $I_C=6\text{A}$ , $V_{GE}=0/15\text{V}$ , $R_G=50\Omega$ , $L_{\sigma}^{(1)}=180\text{nH}$ , $C_{\sigma}^{(1)}=250\text{pF}$ Energy losses include "tail" and diode reverse recovery.	-	24	29	ns
Rise time	$t_r$		-	17	20	
Turn-off delay time	$t_{d(off)}$		-	248	298	
Fall time	$t_f$		-	70	84	
Turn-on energy	$E_{on}$		-	0.167	0.192	mJ
Turn-off energy	$E_{off}$		-	0.153	0.199	
Total switching energy	$E_{ts}$		-	0.320	0.391	

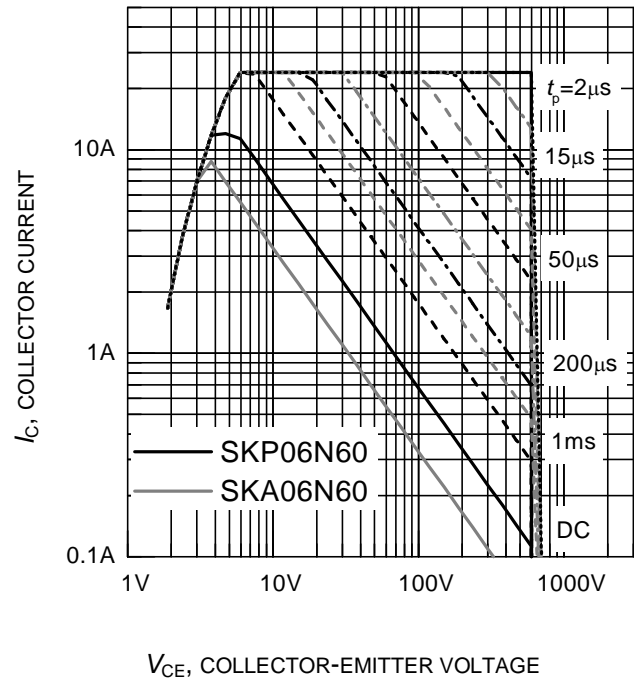
**Anti-Parallel Diode Characteristic**

Diode reverse recovery time	$t_{rr}$	$T_j=150^\circ\text{C}$ $V_R=200\text{V}$ , $I_F=6\text{A}$ , $di_F/dt=200\text{A}/\mu\text{s}$	-	290	-	ns
	$t_S$		-	27	-	
	$t_F$		-	263	-	
Diode reverse recovery charge	$Q_{rr}$		-	500	-	nC
Diode peak reverse recovery current	$I_{rrm}$		-	5.0	-	A
Diode peak rate of fall of reverse recovery current during $t_b$	$di_{rr}/dt$	-	200	-	A/ $\mu\text{s}$	

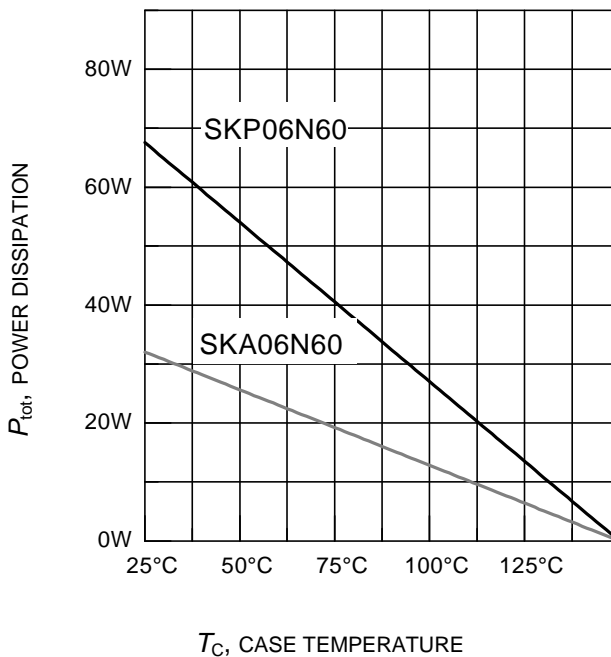
<sup>1)</sup> Leakage inductance  $L_{\sigma}$  and Stray capacity  $C_{\sigma}$  due to dynamic test circuit in Figure E.



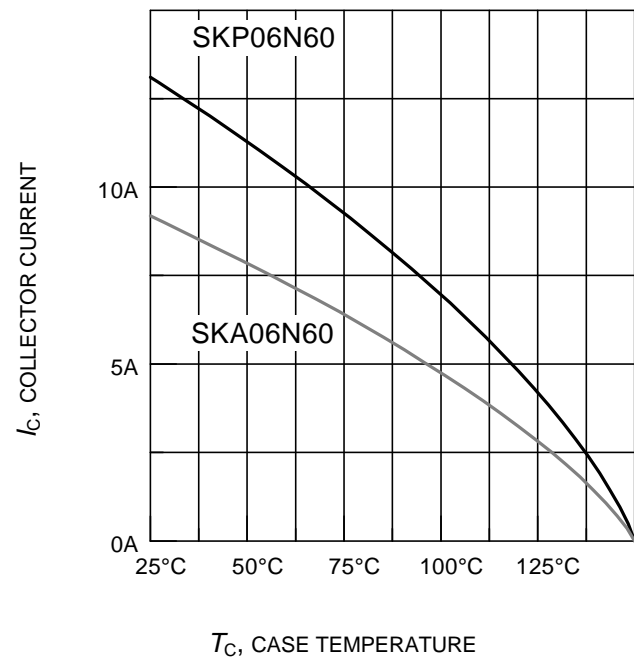
**Figure 1. Collector current as a function of switching frequency**  
 ( $T_j \leq 150^\circ\text{C}$ ,  $D = 0.5$ ,  $V_{CE} = 400\text{V}$ ,  $V_{GE} = 0/+15\text{V}$ ,  $R_G = 50\Omega$ )



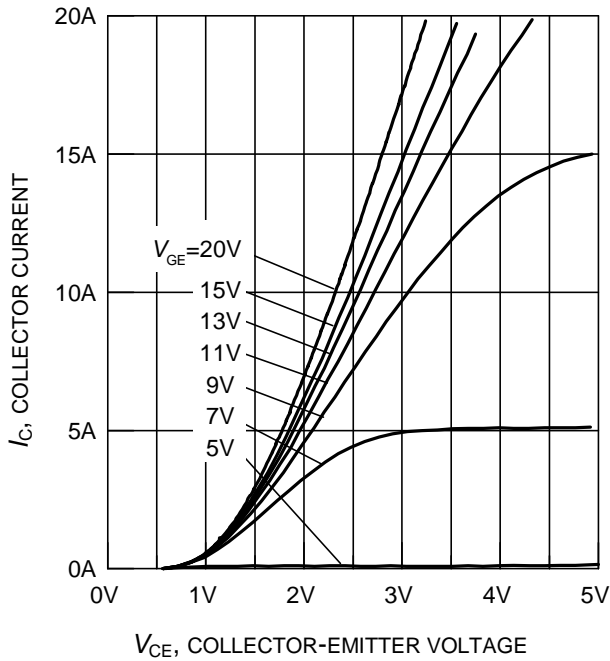
**Figure 2. Safe operating area**  
 ( $D = 0$ ,  $T_C = 25^\circ\text{C}$ ,  $T_j \leq 150^\circ\text{C}$ )



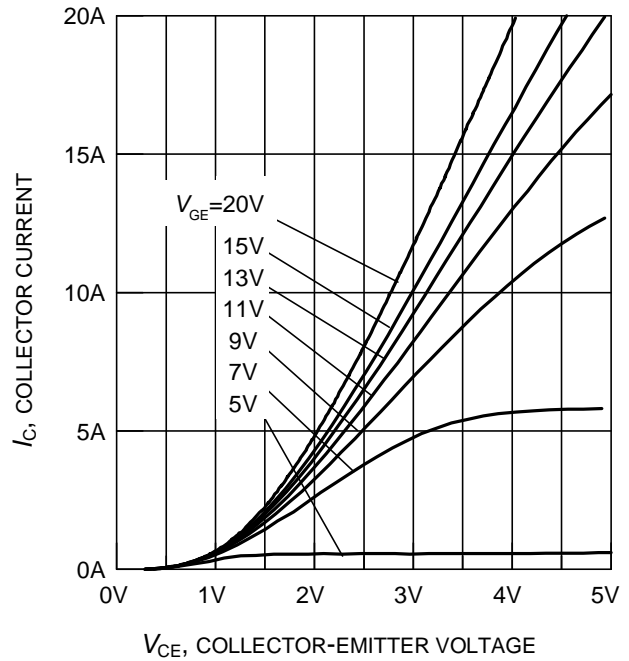
**Figure 3. Power dissipation as a function of case temperature**  
 ( $T_j \leq 150^\circ\text{C}$ )



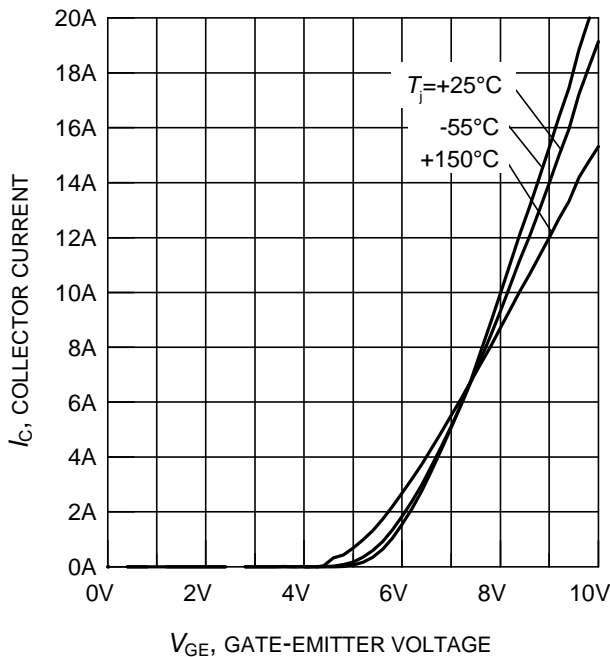
**Figure 4. Collector current as a function of case temperature**  
 ( $V_{GE} \leq 15\text{V}$ ,  $T_j \leq 150^\circ\text{C}$ )



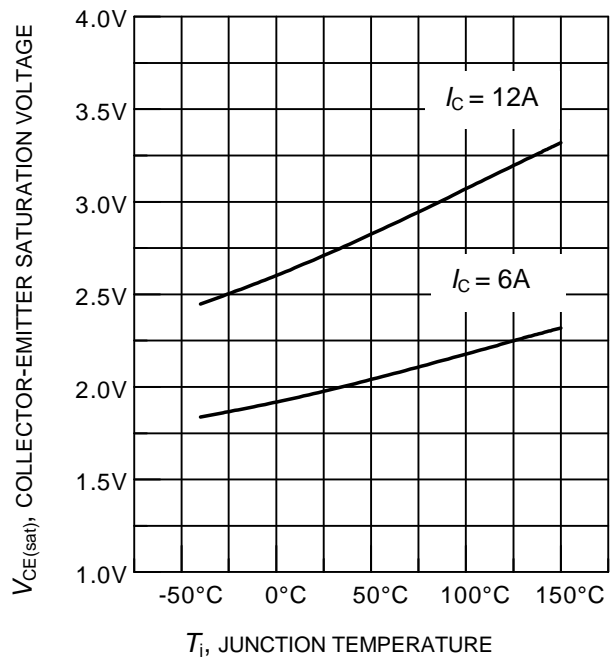
**Figure 5. Typical output characteristics**  
( $T_j = 25^\circ\text{C}$ )



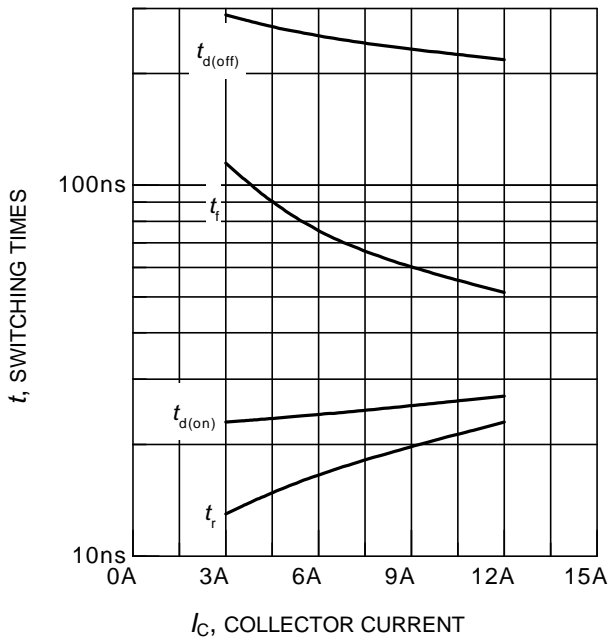
**Figure 6. Typical output characteristics**  
( $T_j = 150^\circ\text{C}$ )



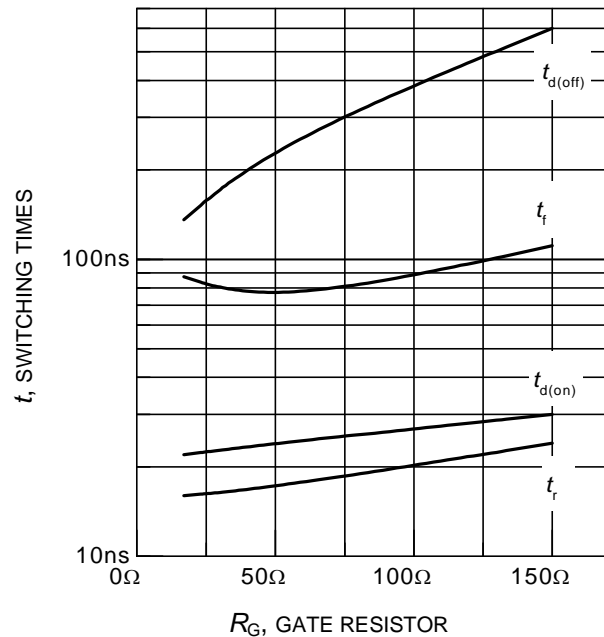
**Figure 7. Typical transfer characteristics**  
( $V_{CE} = 10\text{V}$ )



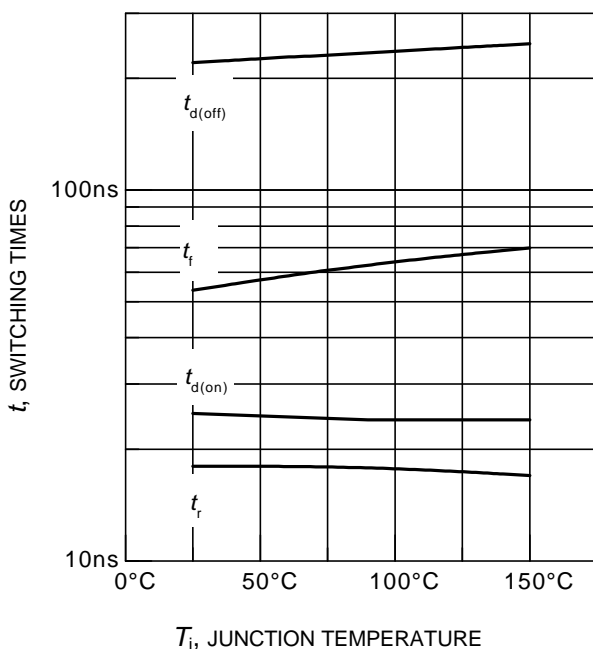
**Figure 8. Typical collector-emitter saturation voltage as a function of junction temperature**  
( $V_{GE} = 15\text{V}$ )



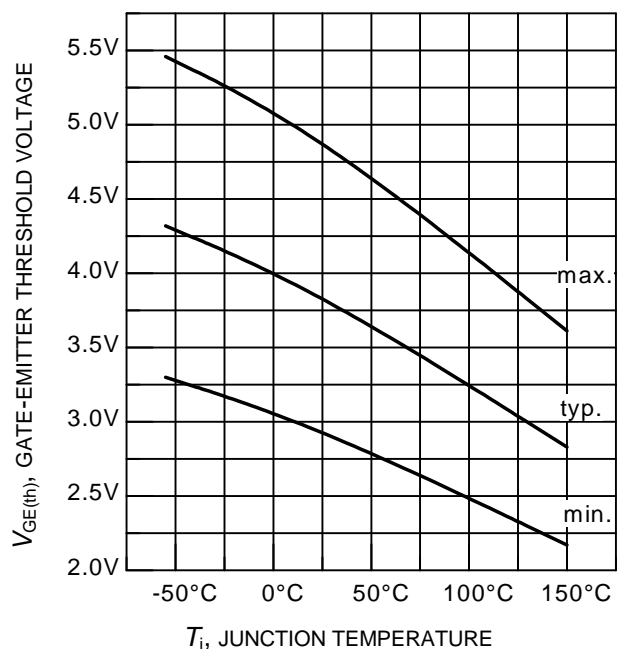
**Figure 9. Typical switching times as a function of collector current**  
(inductive load,  $T_j = 150^\circ\text{C}$ ,  $V_{CE} = 400\text{V}$ ,  $V_{GE} = 0/+15\text{V}$ ,  $R_G = 50\Omega$ , Dynamic test circuit in Figure E)



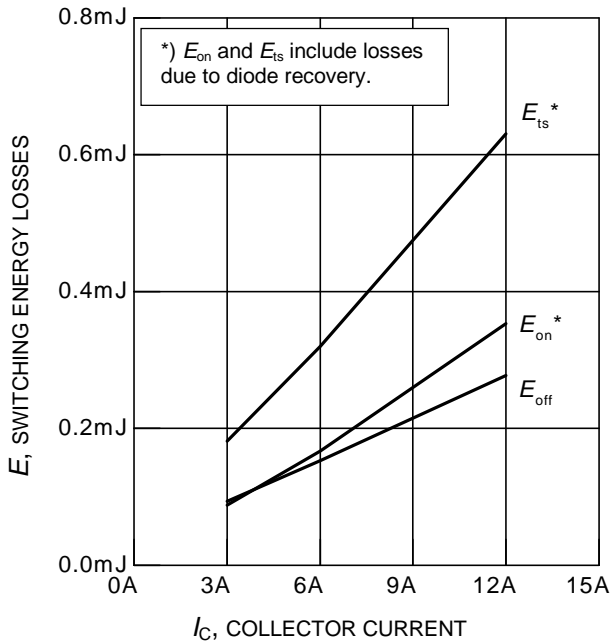
**Figure 10. Typical switching times as a function of gate resistor**  
(inductive load,  $T_j = 150^\circ\text{C}$ ,  $V_{CE} = 400\text{V}$ ,  $V_{GE} = 0/+15\text{V}$ ,  $I_C = 6\text{A}$ , Dynamic test circuit in Figure E)



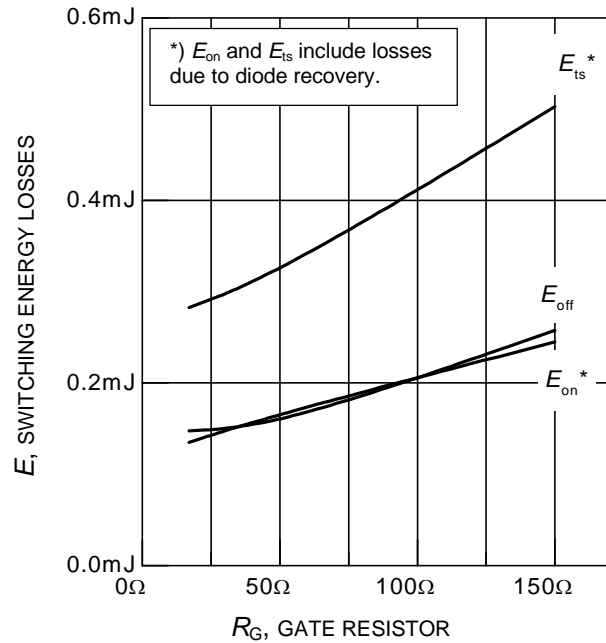
**Figure 11. Typical switching times as a function of junction temperature**  
(inductive load,  $V_{CE} = 400\text{V}$ ,  $V_{GE} = 0/+15\text{V}$ ,  $I_C = 6\text{A}$ ,  $R_G = 50\Omega$ , Dynamic test circuit in Figure E)



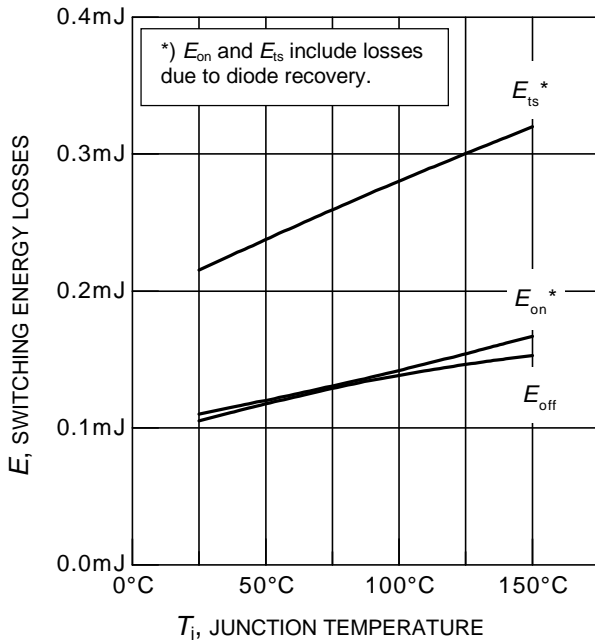
**Figure 12. Gate-emitter threshold voltage as a function of junction temperature**  
( $I_C = 0.25\text{mA}$ )



**Figure 13. Typical switching energy losses as a function of collector current**  
(inductive load,  $T_j = 150^\circ\text{C}$ ,  $V_{CE} = 400\text{V}$ ,  $V_{GE} = 0/+15\text{V}$ ,  $R_G = 50\Omega$ , Dynamic test circuit in Figure E)

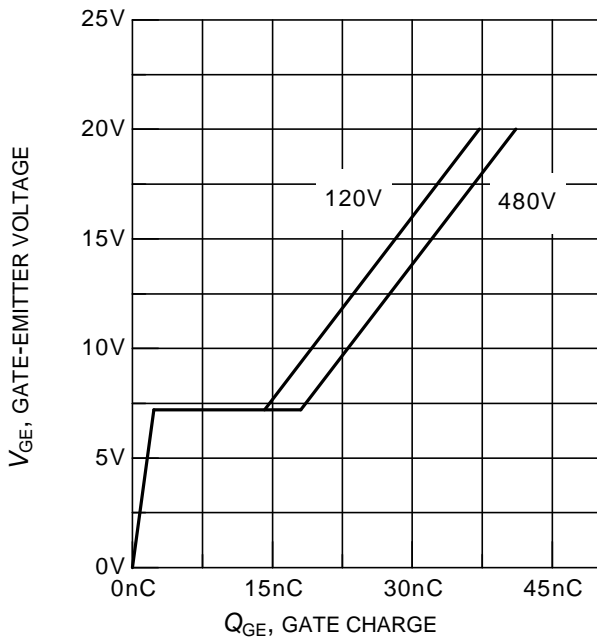


**Figure 14. Typical switching energy losses as a function of gate resistor**  
(inductive load,  $T_j = 150^\circ\text{C}$ ,  $V_{CE} = 400\text{V}$ ,  $V_{GE} = 0/+15\text{V}$ ,  $I_C = 6\text{A}$ , Dynamic test circuit in Figure E)

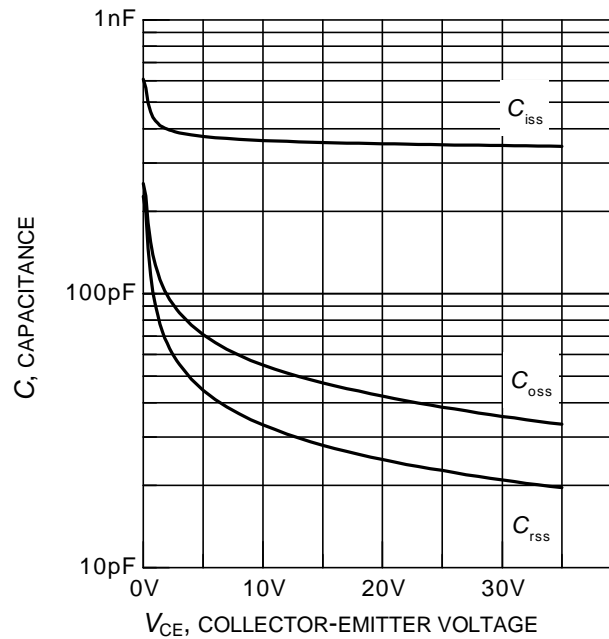


**Figure 15. Typical switching energy losses as a function of junction temperature**  
(inductive load,  $V_{CE} = 400\text{V}$ ,  $V_{GE} = 0/+15\text{V}$ ,  $I_C = 6\text{A}$ ,  $R_G = 50\Omega$ , Dynamic test circuit in Figure E)

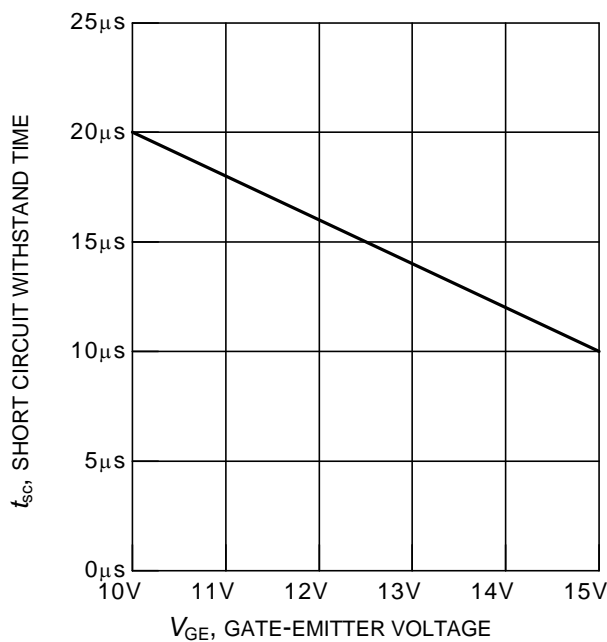




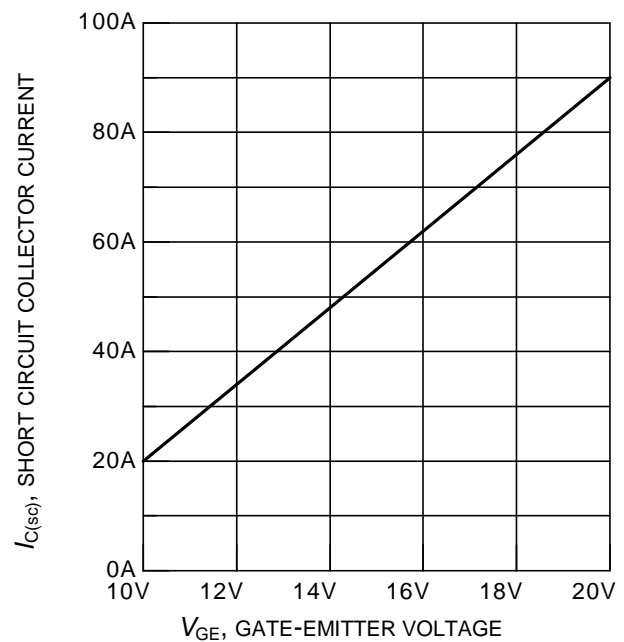
**Figure 16. Typical gate charge**  
( $I_C = 6A$ )



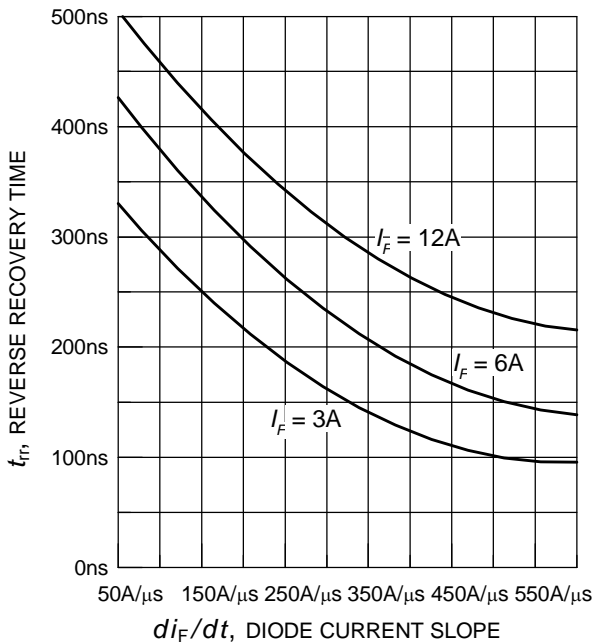
**Figure 17. Typical capacitance as a function of collector-emitter voltage**  
( $V_{GE} = 0V, f = 1MHz$ )



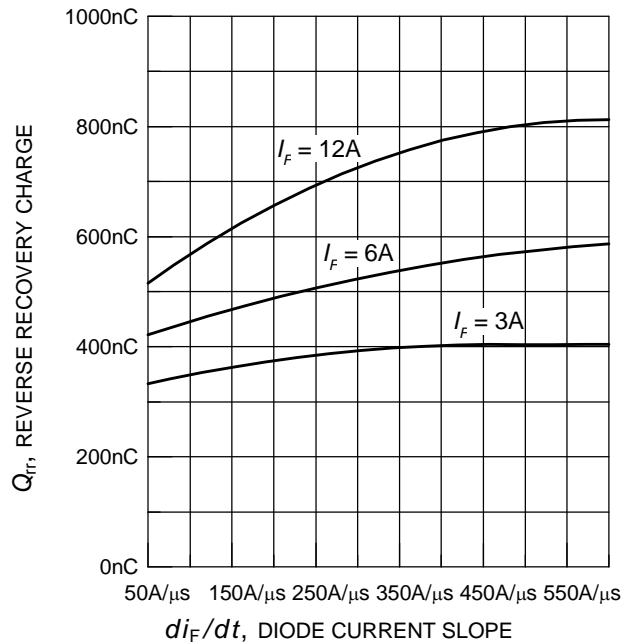
**Figure 18. Short circuit withstand time as a function of gate-emitter voltage**  
( $V_{CE} = 600V, \text{start at } T_j = 25^\circ C$ )



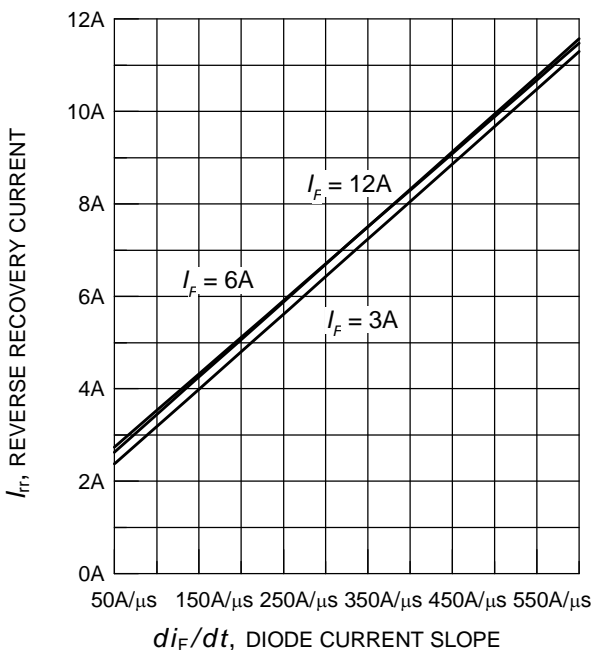
**Figure 19. Typical short circuit collector current as a function of gate-emitter voltage**  
( $V_{CE} \leq 600V, T_j = 150^\circ C$ )



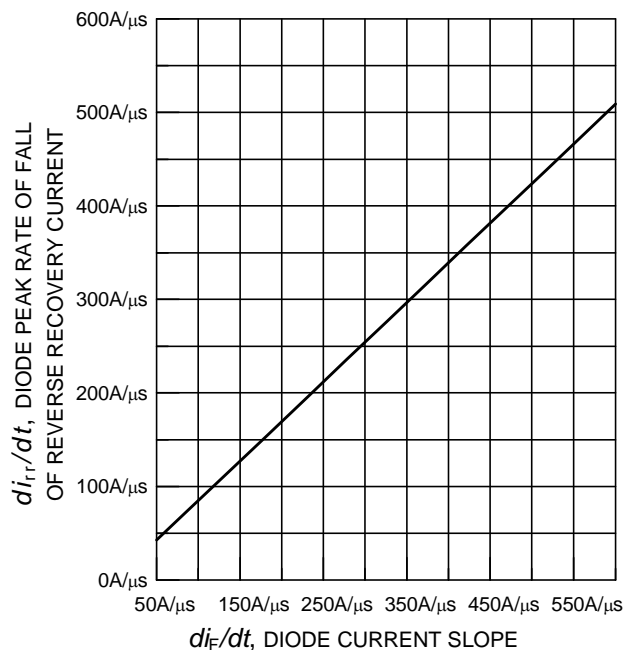
**Figure 20. Typical reverse recovery time as a function of diode current slope**  
( $V_R = 200V$ ,  $T_j = 125^\circ C$ ,  
Dynamic test circuit in Figure E)



**Figure 21. Typical reverse recovery charge as a function of diode current slope**  
( $V_R = 200V$ ,  $T_j = 125^\circ C$ ,  
Dynamic test circuit in Figure E)



**Figure 22. Typical reverse recovery current as a function of diode current slope**  
( $V_R = 200V$ ,  $T_j = 125^\circ C$ ,  
Dynamic test circuit in Figure E)



**Figure 23. Typical diode peak rate of fall of reverse recovery current as a function of diode current slope**  
( $V_R = 200V$ ,  $T_j = 125^\circ C$ ,  
Dynamic test circuit in Figure E)

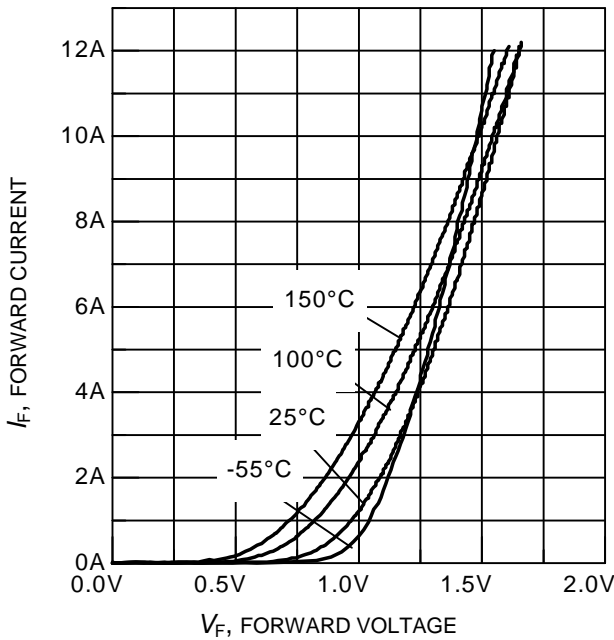


Figure 24. Typical diode forward current as a function of forward voltage

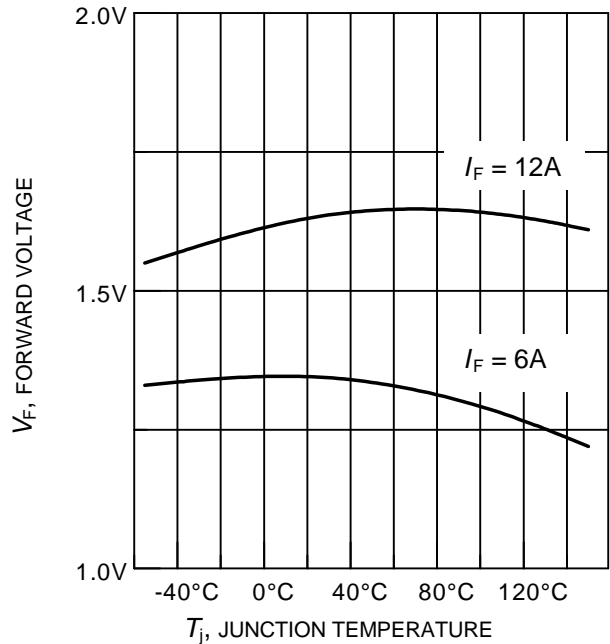


Figure 25. Typical diode forward voltage as a function of junction temperature

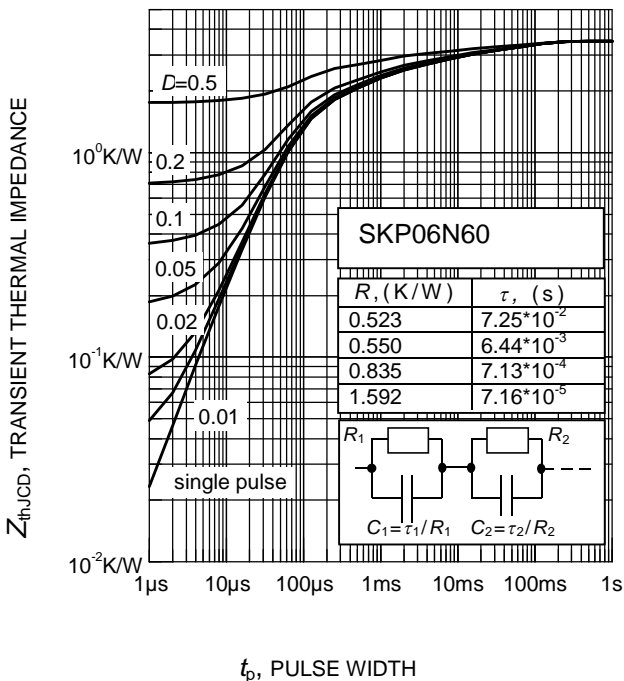


Figure 26. Diode transient thermal impedance as a function of pulse width ( $D = t_p / T$ )

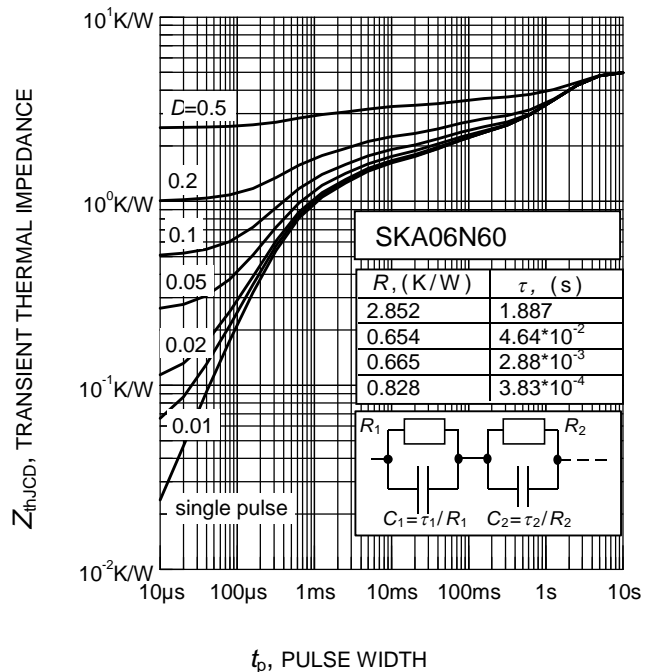
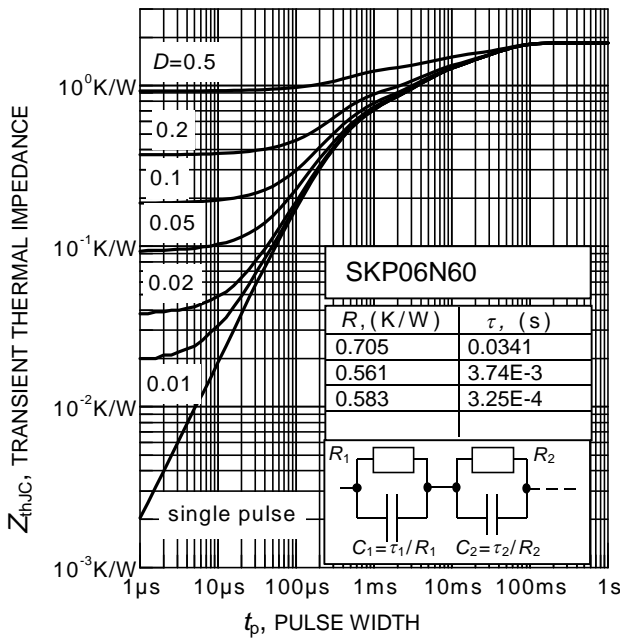
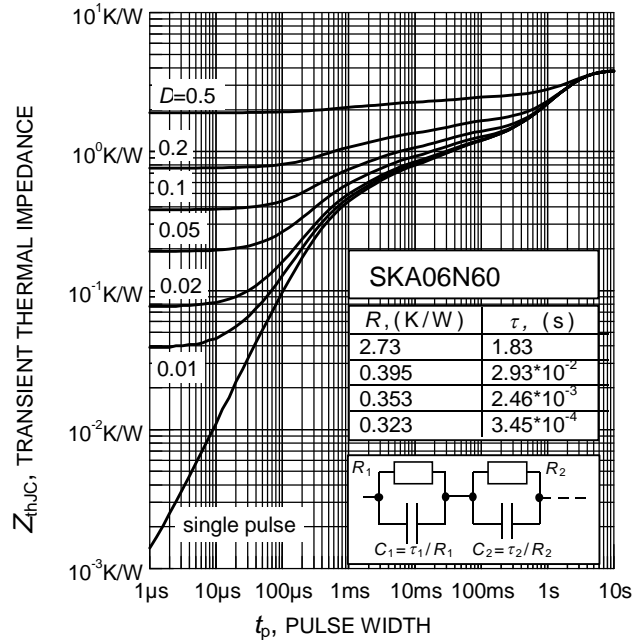


Figure 27. Diode transient thermal impedance as a function of pulse width ( $D = t_p / T$ )

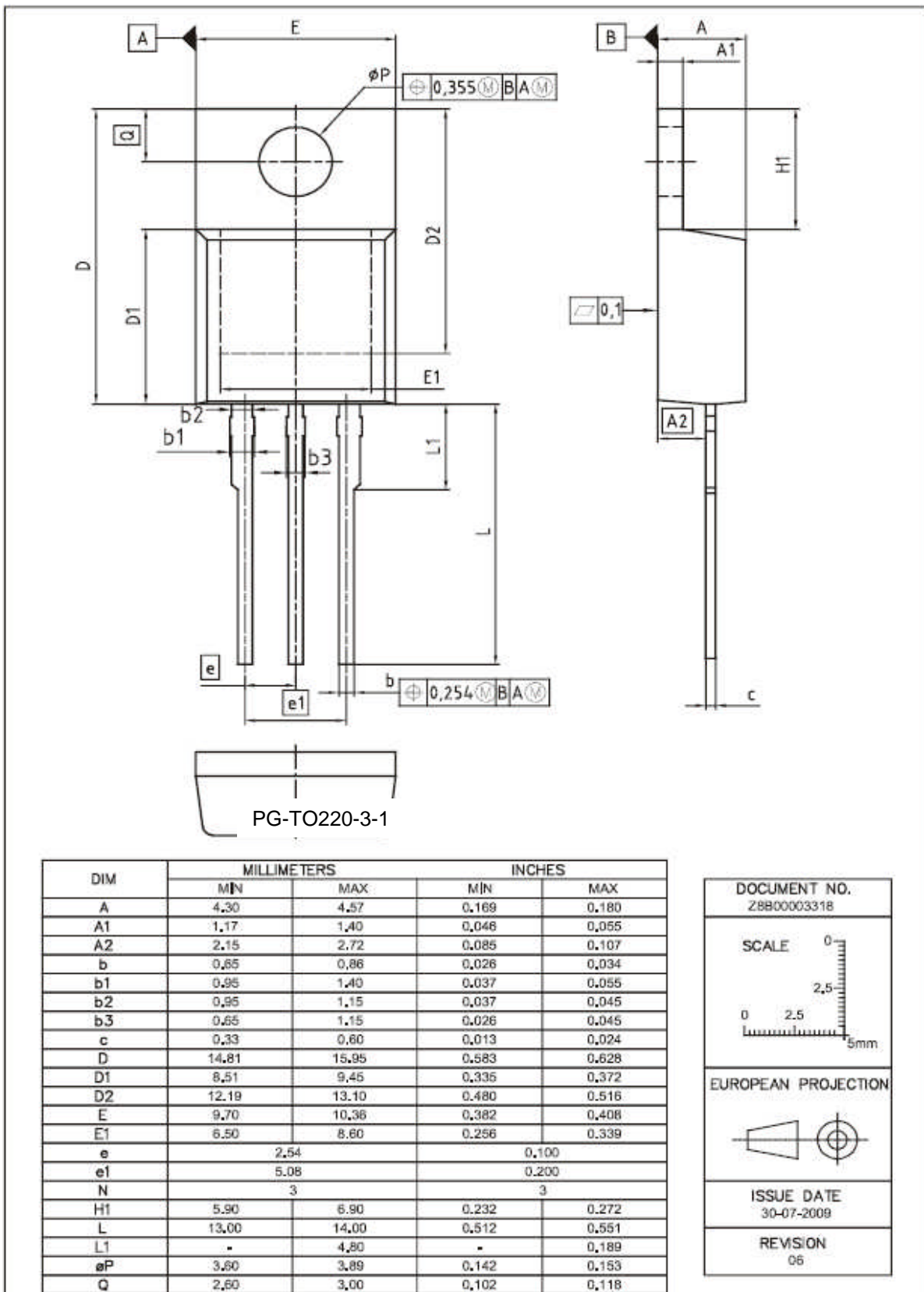


**Figure 28. IGBT transient thermal impedance as a function of pulse width**  
( $D = t_p / T$ )

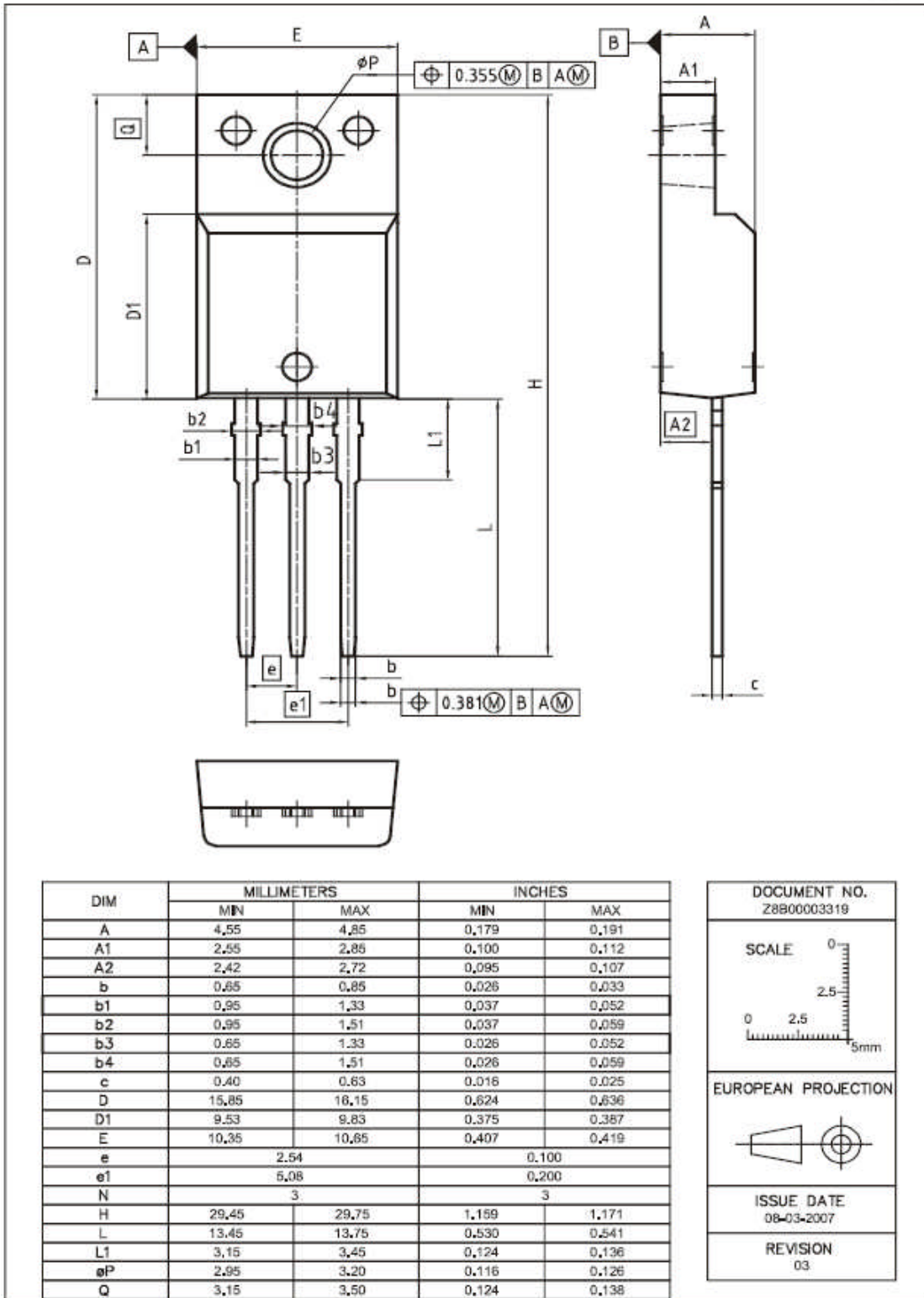


**Figure 29. IGBT transient thermal impedance as a function of pulse width**  
( $D = t_p / T$ )

PG-TO220-3



PG-TO220-3-FP



Please refer to mounting instructions

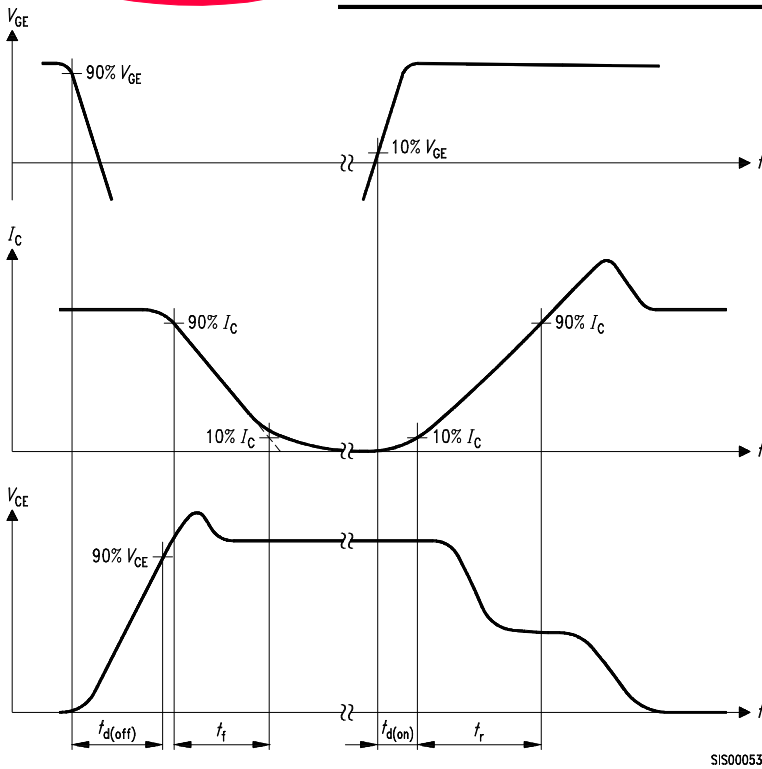


Figure A. Definition of switching times

SIS00053

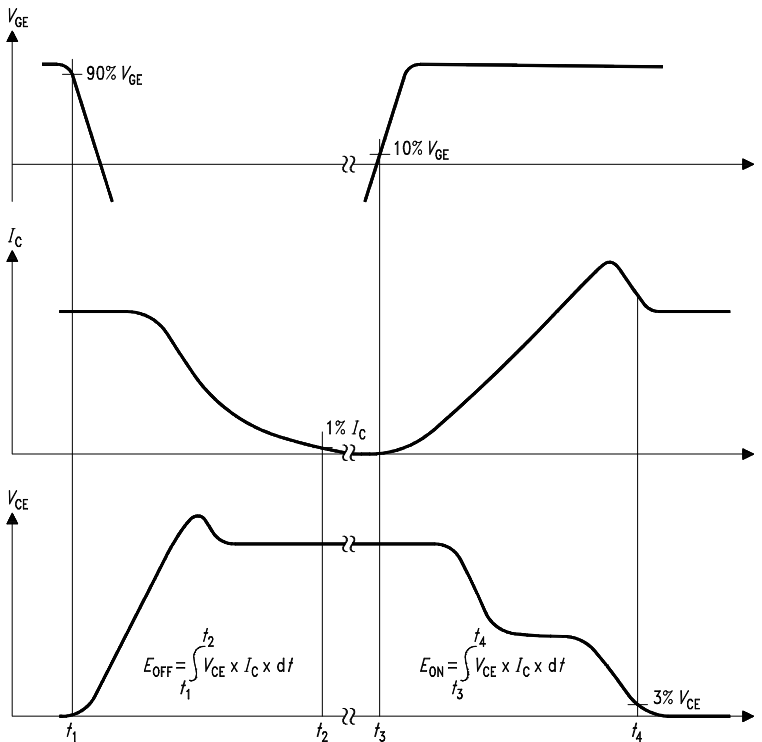


Figure B. Definition of switching losses

SIS00050

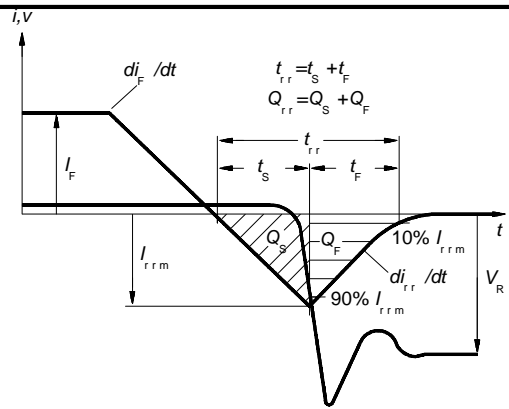


Figure C. Definition of diodes switching characteristics

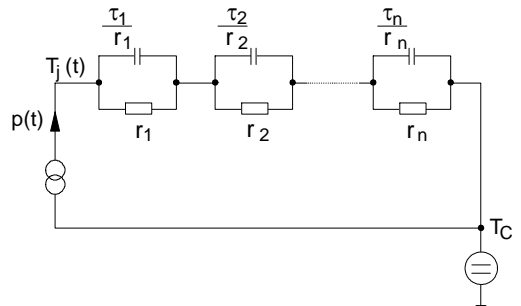


Figure D. Thermal equivalent circuit

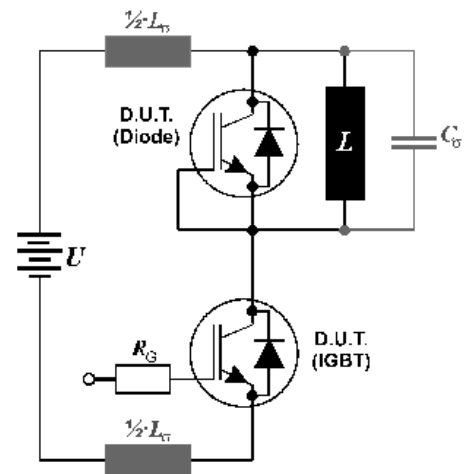


Figure E. Dynamic test circuit  
Leakage inductance  $L_{\sigma} = 180\text{nH}$   
and Stray capacity  $C_{\sigma} = 250\text{pF}$ .

**Published by**  
**Infineon Technologies AG**  
**81726 Munich, Germany**  
**© 2013 Infineon Technologies AG**  
**All Rights Reserved.**

### **Legal Disclaimer**

The information given in this document shall in no event be regarded as a guarantee of conditions or characteristics. With respect to any examples or hints given herein, any typical values stated herein and/or any information regarding the application of the device, Infineon Technologies hereby disclaims any and all warranties and liabilities of any kind, including without limitation, warranties of non-infringement of intellectual property rights of any third party.

### **Information**

For further information on technology, delivery terms and conditions and prices, please contact the nearest Infineon Technologies Office ([www.infineon.com](http://www.infineon.com)).

### **Warnings**

Due to technical requirements, components may contain dangerous substances. For information on the types in question, please contact the nearest Infineon Technologies Office.  
The Infineon Technologies component described in this Data Sheet may be used in life-support devices or systems and/or automotive, aviation and aerospace applications or systems only with the express written approval of Infineon Technologies, if a failure of such components can reasonably be expected to cause the failure of that life-support, automotive, aviation and aerospace device or system or to affect the safety or effectiveness of that device or system. Life support devices or systems are intended to be implanted in the human body or to support and/or maintain and sustain and/or protect human life. If they fail, it is reasonable to assume that the health of the user or other persons may be endangered.



## X-ON Electronics

Largest Supplier of Electrical and Electronic Components

*Click to view similar products for [IGBT Transistors](#) category:*

*Click to view products by [Infineon](#) manufacturer:*

Other Similar products are found below :

[748152A](#) [FGH60T65SHD\\_F155](#) [APT100GT60B2RG](#) [APT13GP120BG](#) [APT20GN60BG](#) [APT20GT60BRDQ1G](#) [APT25GN120B2DQ2G](#)  
[APT35GA90BD15](#) [APT36GA60BD15](#) [APT40GP60B2DQ2G](#) [APT40GP90B2DQ2G](#) [APT50GN120B2G](#) [APT50GT60BRG](#)  
[APT64GA90B2D30](#) [APT70GR120J](#) [NGTB10N60FG](#) [NGTB30N60L2WG](#) [NGTG25N120FL2WG](#) [IGP30N60H3XKSA1](#) [STGB15H60DF](#)  
[STGFW20V60DF](#) [STGFW30V60DF](#) [STGFW40V60F](#) [STGWA25H120DF2](#) [FGB3236\\_F085](#) [APT25GN120BG](#) [APT25GR120S](#)  
[APT30GN60BDQ2G](#) [APT30GN60BG](#) [APT30GP60BG](#) [APT30GS60BRDQ2G](#) [APT30N60BC6](#) [APT35GP120JDQ2](#) [APT36GA60B](#)  
[APT45GR65B2DU30](#) [APT50GP60B2DQ2G](#) [APT68GA60B](#) [APT70GR65B](#) [APT70GR65B2SCD30](#) [GT50JR22\(STA1ES\)](#) [TIG058E8-TL-H](#)  
[IDW40E65D2](#) [SGB15N120ATMA1](#) [NGTB50N60L2WG](#) [STGB10H60DF](#) [STGB20V60F](#) [STGB40V60F](#) [STGFW80V60F](#)  
[IGW40N120H3FKSA1](#) [RJH60D7BDPQ-E0#T2](#)