

V _{RSM}	V _{RRM}	(dv/dt) _{cr}	I _{TRMS} (maximum value for continuous operation)			
			220 A	250 A	220 A	250 A
V	V	V/μs	I _{TAV} (sin. 180; T _{case} = 80 °C)			
			148 A	168 A	148 A	168 A
			SKKT	SKKT	SKKH	SKKH
900	800	500	132/08 D	162/08 D	132/08 D	162/08 D
1300	1200	1000	132/12 E	162/12 E	132/12 E	162/12 E
1500	1400	1000	132/14 E	162/14 E	132/14 E	162/14 E
1700	1600	1000	132/16 E	162/16 E	132/16 E	162/16 E
1900	1800	1000	132/18 E	162/18 E	132/18 E	162/18 E

SEMIKRON® 2 Thyristor / Diode Modules

SKKT 132 **SKKH 132**
SKMT 132¹⁾ **SKNH 132¹⁾**
SKKT 162 **SKKH 162**

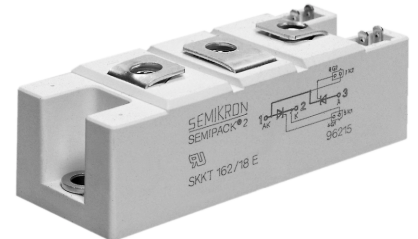

Symbol	Conditions	SKKT 132 SKKH 132	SKKT 162 SKKH 162	Units
I _{TAV}	sin. 180; (T _{case} = . . .)	130 (87 °C)	160 (83 °C)	A
I _D	B2/B6 T _{amb} = 45 °C; P 3/180 T _{amb} = 35 °C; P 3/180 F	77 / 100	–	A
		170 / 200	190 / 230	A
		250 / 320	290 / 360	A
I _{RMS}	W1/W3 P 3/180 F P 16/200 F	240 / 3 x 163	265 / 3 x 185	A
		305 / 3 x 250	333 / 3 x 312	A
I _{TSM}	T _{vj} = 25 °C; 10 ms	4 700	5 400	A
i ² t	T _{vj} = 125 °C; 10 ms	4 000	5 000	A
	T _{vj} = 25 °C; 8,3 ... 10 ms	110 000	145 000	A ² s
	T _{vj} = 125 °C; 8,3 ... 10 ms	80 000	125 000	A ² s
t _{gd}	T _{vj} = 25 °C; I _G = 1 A di _G /dt = 1 A/μs	1		μs
t _{gr}	V _D = 0,67 · V _{DRM}	2		μs
(di/dt) _{cr}	T _{vj} = 125 °C	200		A/μs
t _q	T _{vj} = 125 °C	typ. 50 . . . 150		μs
I _H	T _{vj} = 25 °C; typ./max.	150 / 400		mA
I _L	T _{vj} = 25 °C; R _G = 33 Ω; typ./max.	0,3 / 1		A
V _T	T _{vj} = 25 °C; I _T = 500 A	max. 1,8	max. 1,6	V
V _{T(TO)}	T _{vj} = 125 °C	1	0,85	V
r _T	T _{vj} = 125 °C	1,6	1,5	mΩ
I _{DD} ; I _{RD}	T _{vj} = 125 °C; V _{DRM} ; V _{RRM}	max. 40	max. 40	mA
V _{GT}	T _{vj} = 25 °C; d.c.	2		V
I _{GT}	T _{vj} = 25 °C; d.c.	150		mA
V _{GD}	T _{vj} = 125 °C; d.c.	0,25		V
I _{GD}	T _{vj} = 125 °C; d.c.	10		mA
R _{thjc}	cont. } per thyristor / sin. 180 } per module rec. 120 }	0,18 / 0,09	0,17 / 0,085	°C/W
		0,19 / 0,095	0,18 / 0,09	°C/W
		0,21 / 0,105	0,20 / 0,10	°C/W
		0,10 / 0,05		°C/W
R _{thch}		– 40 ... + 125		°C
T _{vj} , T _{stg}				
V _{isol}	a. c. 50 Hz; r.m.s.; 1 s/1 min	3600 / 3000		V~
M ₁	to heatsink } SI (US) units to terminals }	5 (44 lb. in.) ± 15 % ²⁾		Nm
M ₂		5 (44 lb. in.) ± 15 %		Nm
a		5 · 9,81		m/s ²
w	approx.	165		g
Case	→ page B 1 – 96	SKKT: A 21 SKKH: A 22	SKMT: A 50 SKNH: A 61	

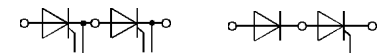

SKKT

SKKH

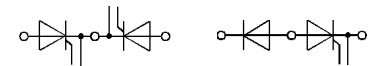

SKMT

SKNH

Features

- Heat transfer through aluminium oxide ceramic isolated metal baseplate
- Hard soldered joints for high reliability
- UL recognized, file no. E 63 532

Typical Applications

- DC motor control (e.g. for machine tools)
- Temperature control (e.g. for ovens, chemical processes)
- Professional light dimming (studios, theaters)
- SKNH 162 for DC braking of induction motors for circuit see data sheet SKNH 56

¹⁾ SKMT 132, SKNH 132 available on request

²⁾ See the assembly instructions

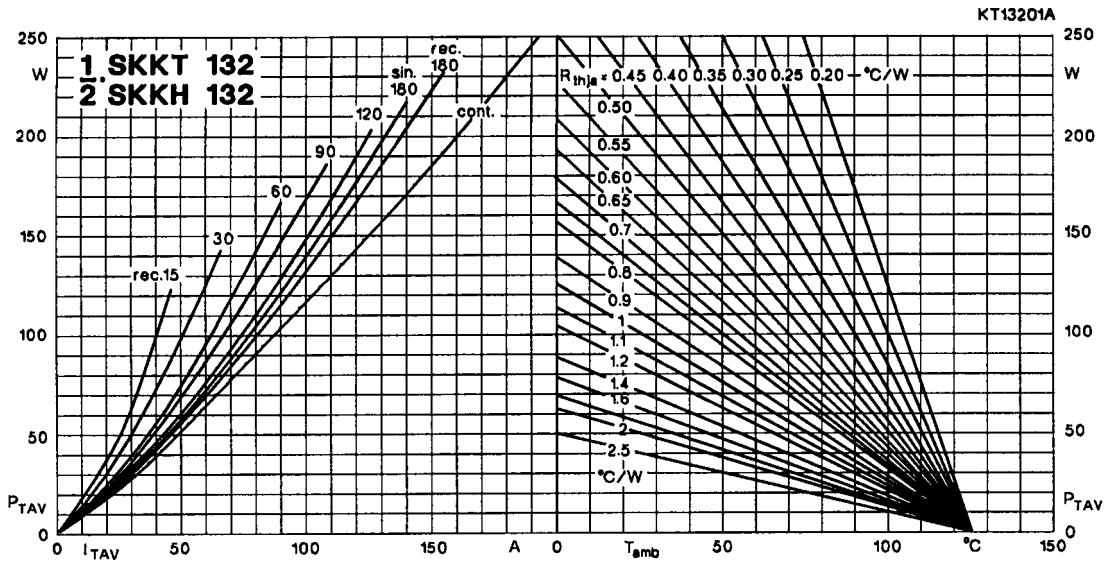

Fig. 1 a Power dissipation per thyristor vs. on-state current and ambient temperature

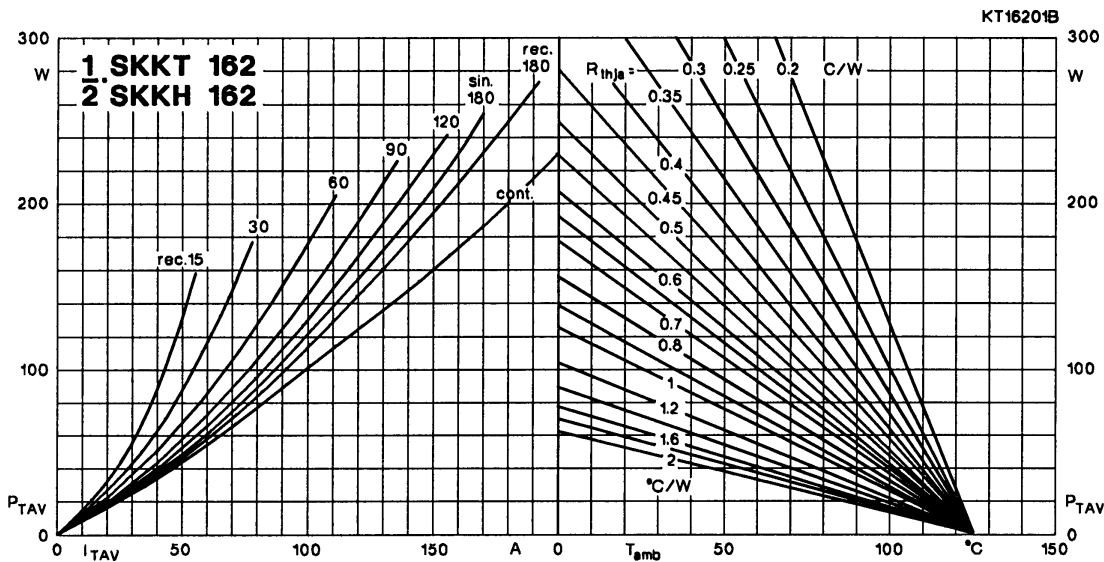

Fig. 1 b Power dissipation per thyristor vs. on-state current and ambient temperature

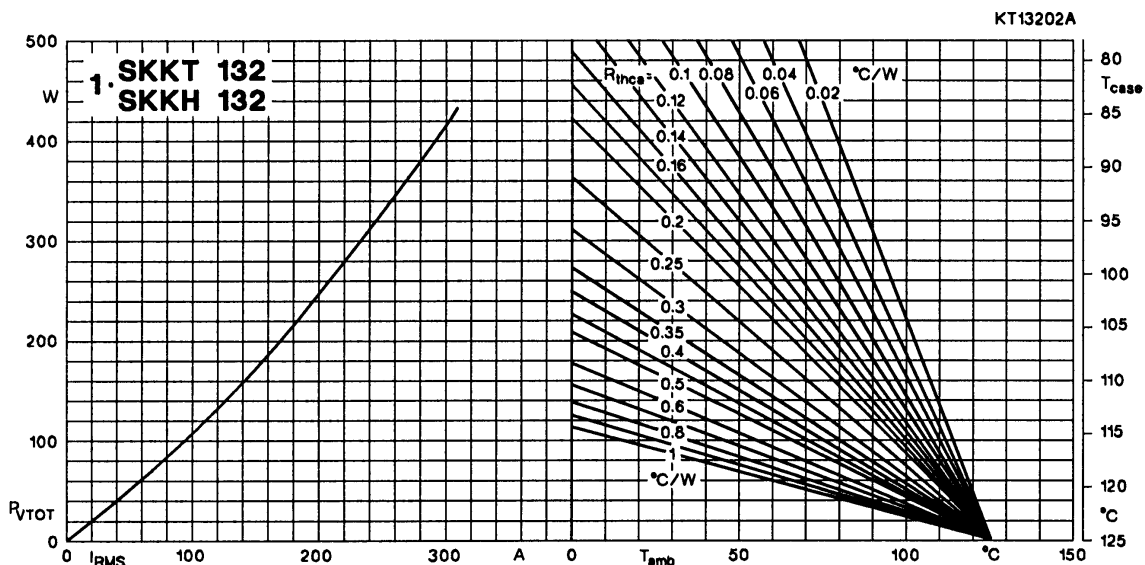

Fig. 2 a Power dissipation per module vs. rms current and case temperature

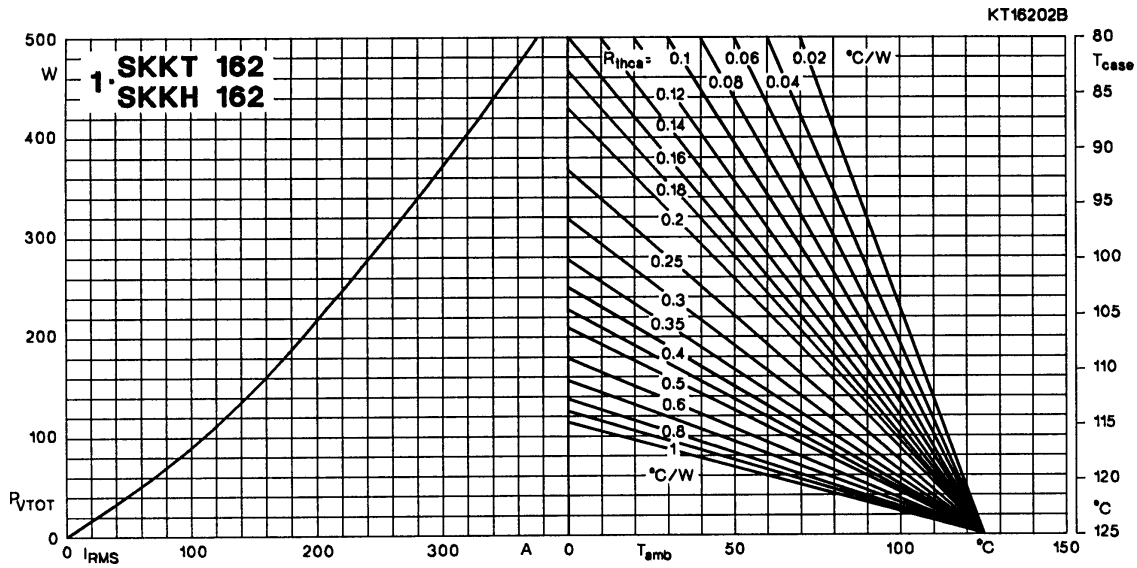

Fig. 2 b Power dissipation per module vs. rms current and case temperature

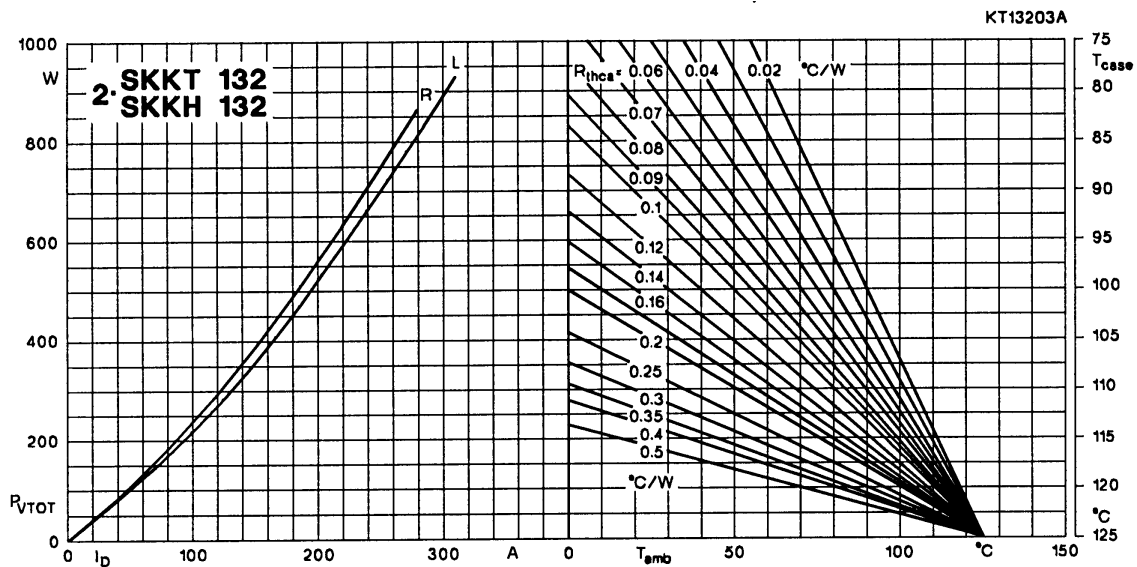

Fig. 3 a Power dissipation of two modules vs. direct current and case temperature

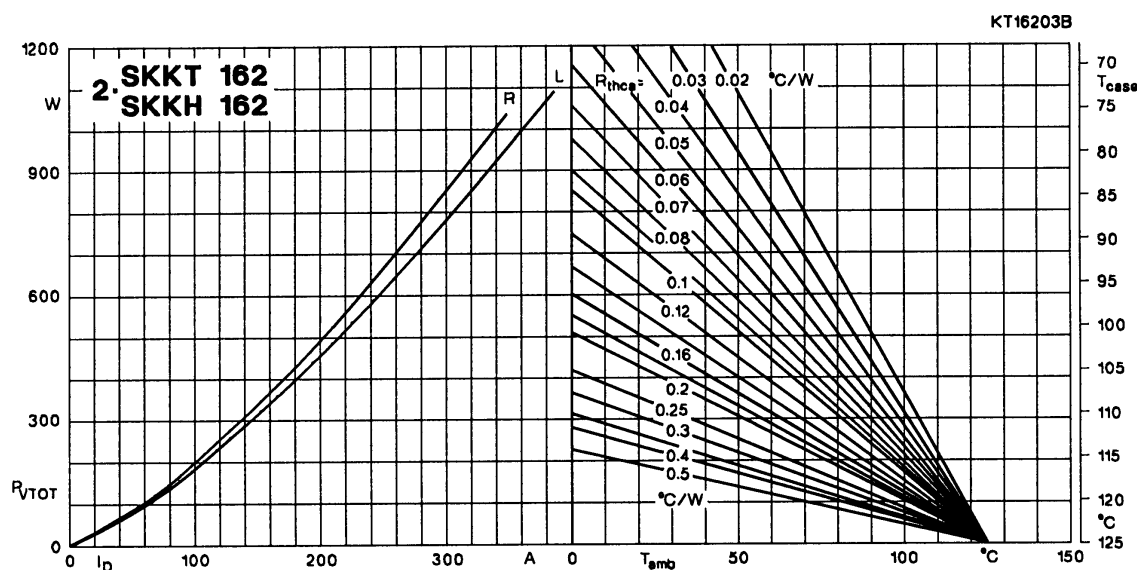

Fig. 3 b Power dissipation of two modules vs. direct current and case temperature

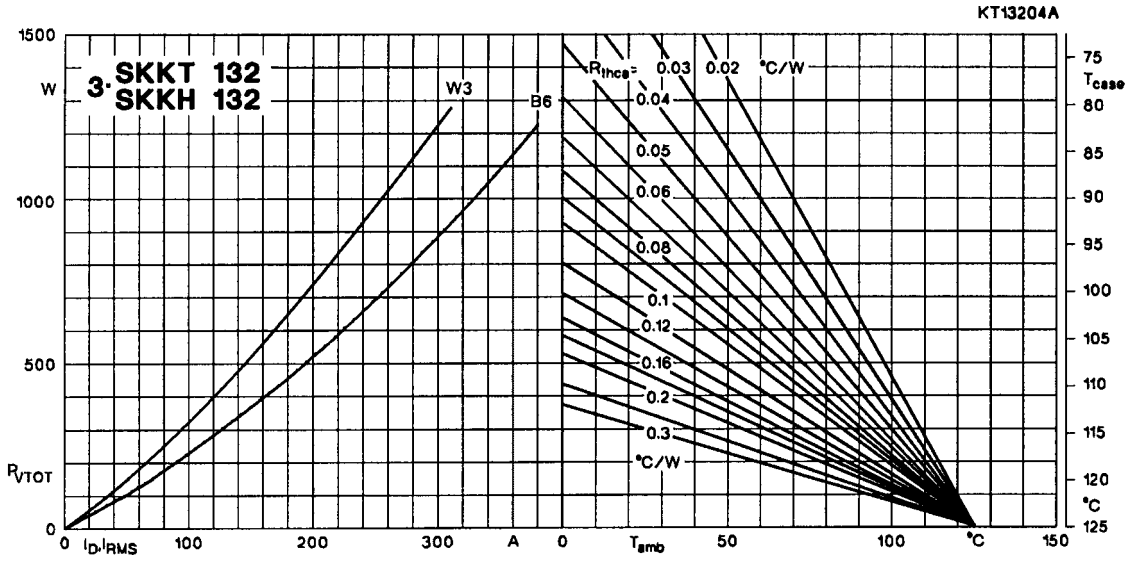

Fig. 4 a Power dissipation of three modules vs. direct and rms current and case temperature

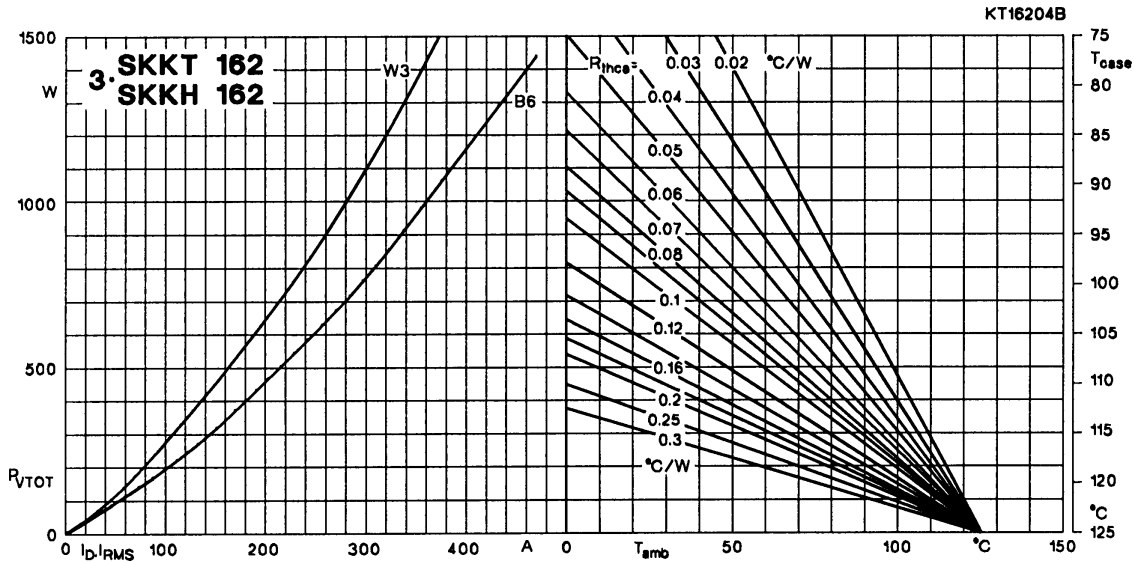

Fig. 4 b Power dissipation of three modules vs. direct and rms current and case temperature

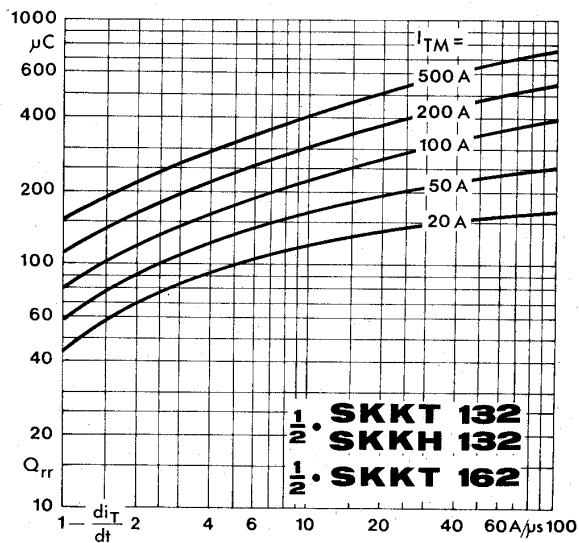

Fig. 5 Recovered charge vs. current decrease

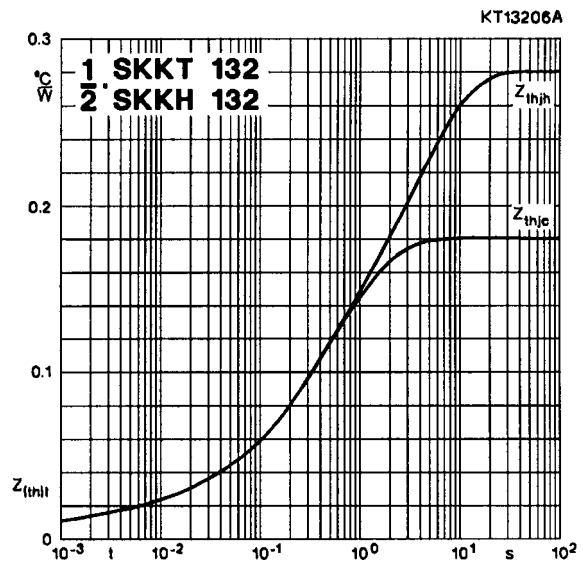

Fig. 6 a Transient thermal impedance vs. time

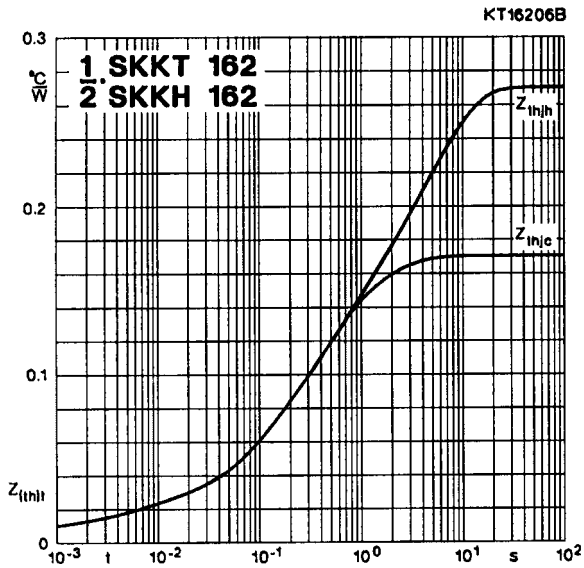

Fig. 6 b Transient thermal impedance vs. time

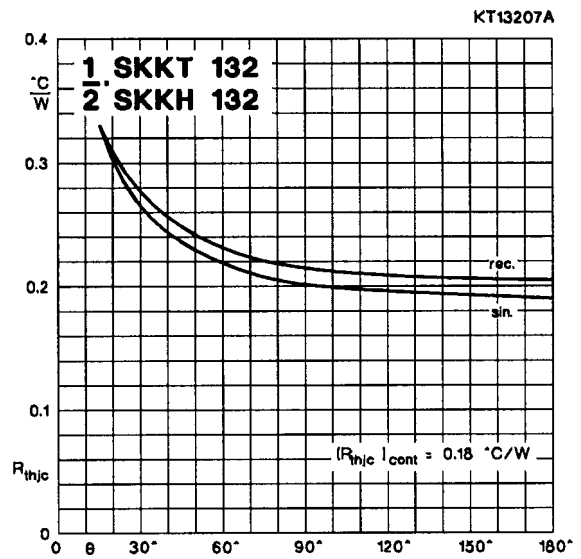

Fig. 7 a Thermal resistance vs. conduction angle

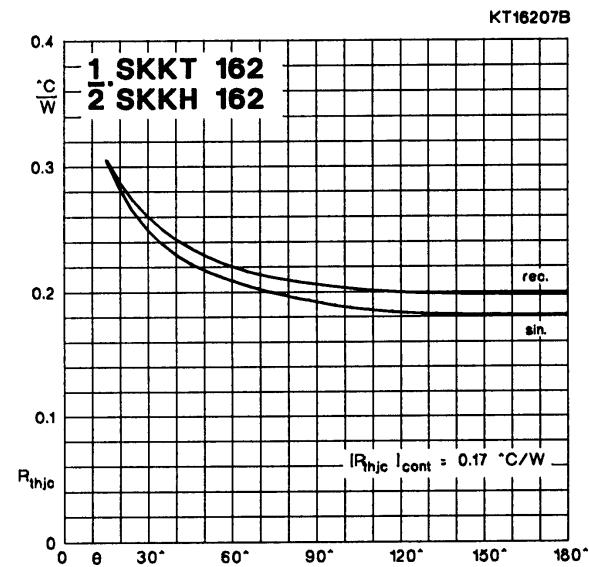

Fig. 7 b Thermal resistance vs. conduction angle

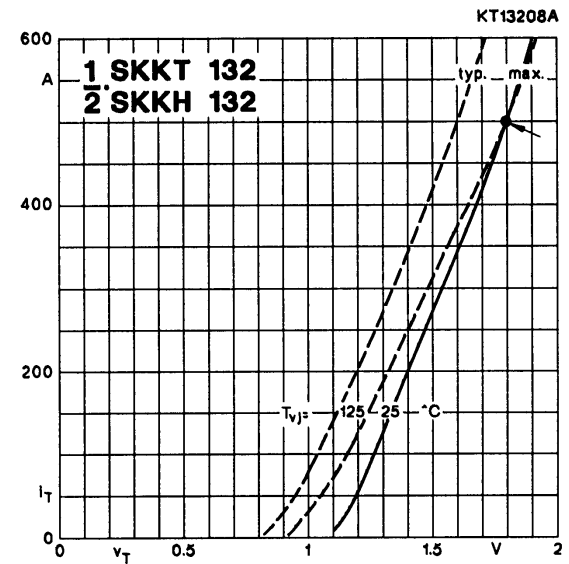

Fig. 8 a On-state characteristics

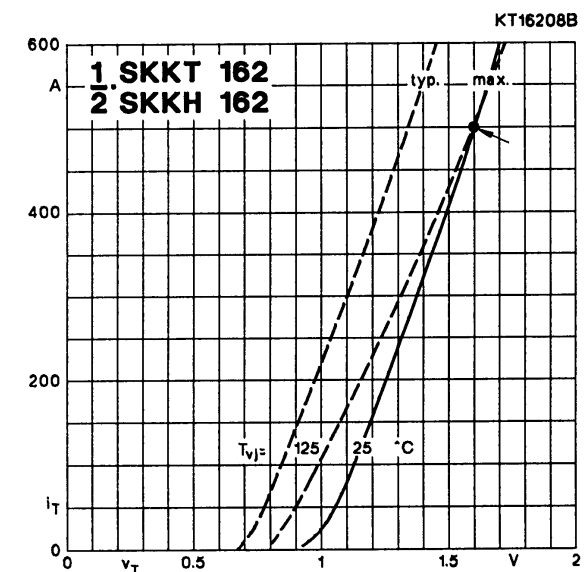

Fig. 8 b On-state characteristics

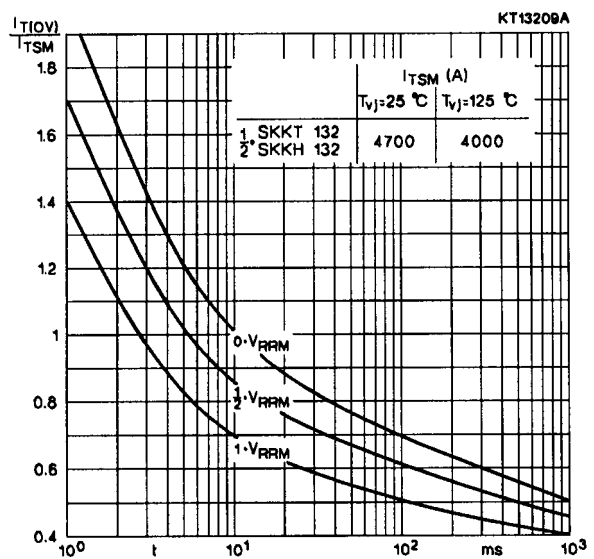

Fig. 9 a Surge overload current vs. time

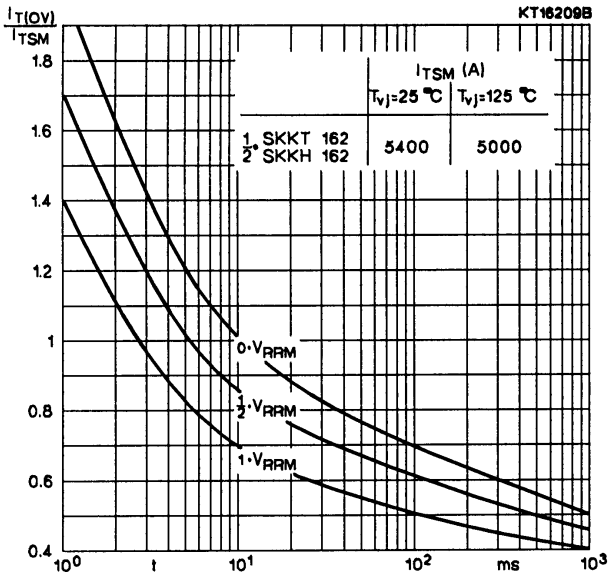

Fig. 9 b Surge overload current vs. time

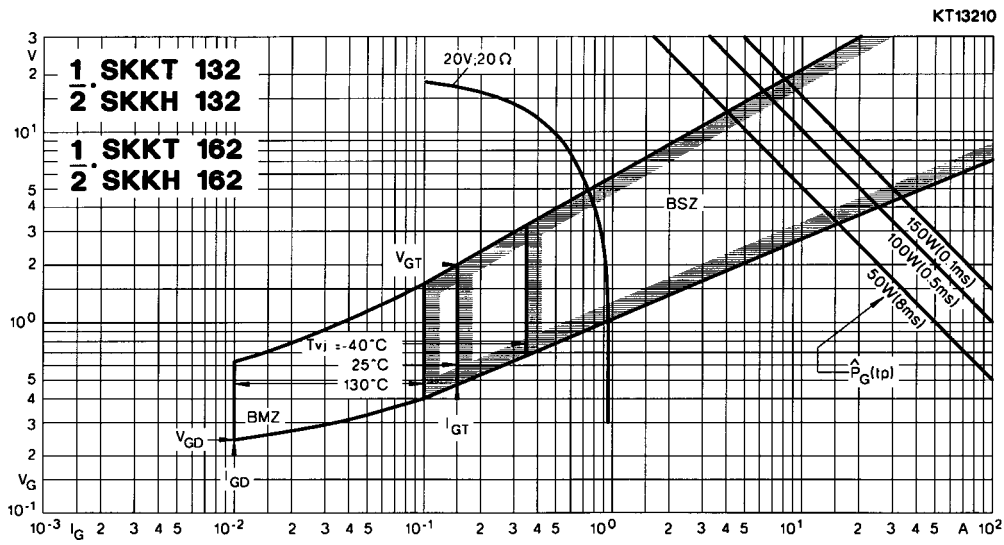
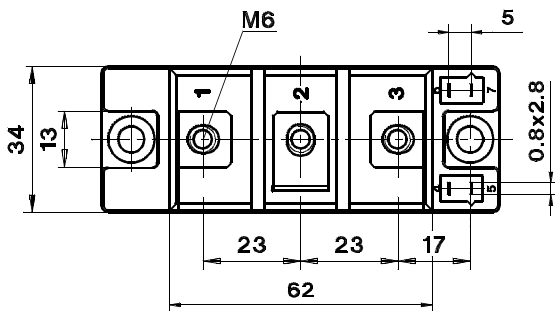
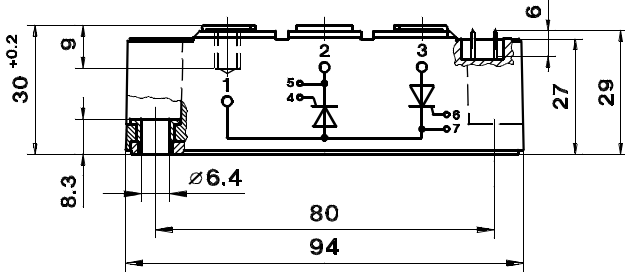

Fig. 10 Gate trigger characteristics

SKKT 122, 132, 162

Case A 21

SEMIPACK® 2 UL recognized, file no. E 63 532



SKMT 132

Case A 50

SEMIPACK® 2 UL recognized, file no. E 63 532

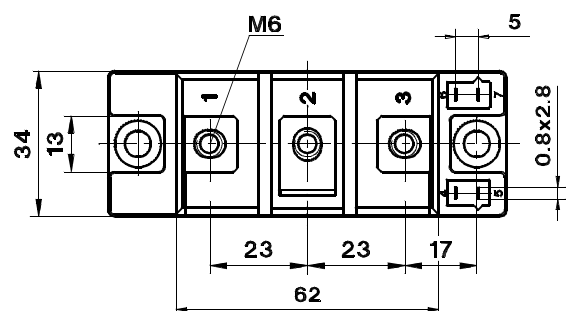
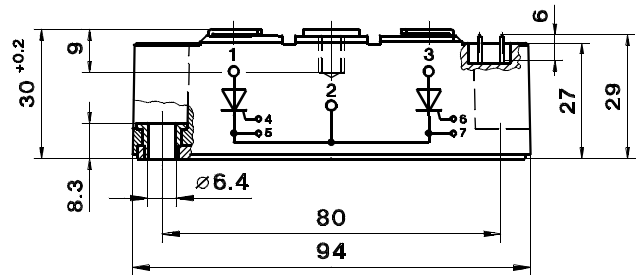

SKKH 122, 132, 162

Case A 22

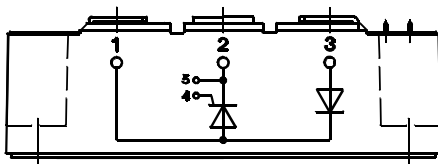

SKND 165

Case A 52

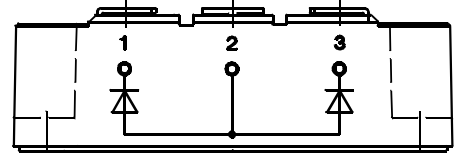

SKKD 162

Case A 23

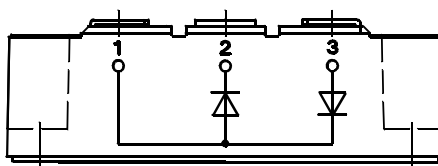

SKND 162

Case A 57

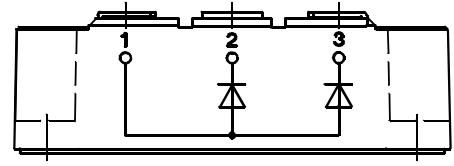

SKKE 162

Case A 24

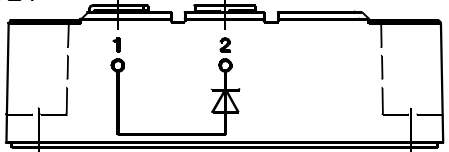

SKNH 132

Case A 61

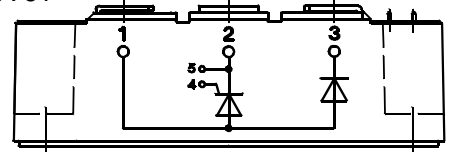

Dimensions in mm

Dimensions in mm

X-ON Electronics

Largest Supplier of Electrical and Electronic Components

Click to view similar products for [SCR Modules](#) category:

Click to view products by [Semikron](#) manufacturer:

Other Similar products are found below :

[DT430N22KOF](#) [T1401N42TOH](#) [T1851N60TOH](#) [T390N14TOF](#) [T420N12TOF](#) [T470N16TOF](#) [T640N16TOF](#) [T901N36TOF](#) [TD140N18KOF](#)
[TD142N16KOF](#) [TD162N16KOF-A](#) [TD250N12KOF](#) [TD330N16AOF](#) [TT215N22KOF](#) [TZ310N20KOF](#) [TZ425N12KOF](#) [TZ500N12KOF](#)
[T300N14TOF](#) [T3710N06TOF](#) [VT](#) [T390N16TOF](#) [T460N24TOF](#) [T501N70TOH](#) [T560N16TOF](#) [T640N14TOF](#) [TD250N14KOF](#)
[TT600N16KOF](#) [TZ500N16KOF](#) [TZ240N36KOF](#) [TT210N12KOF](#) [NTE5710](#) [TD180N16KOF](#) [TT240N28KOF](#) [TZ425N14KOF](#)
[T1081N60TOH](#) [TT61N08KOF](#) [TD251N18KOF](#) [TT162N08KOF](#) [TZ430N22KOF](#) [TT180N12KOF](#) [T2001N34TOF](#) [TD140N22KOF](#)
[MDMA200P1600SA](#) [TT180N16KOF](#) [VS-ST333C08LFM0](#) [VS-ST180C14C0L](#) [T1080N02TOF](#) [TD320N16SOF](#) [T360N22TOF](#)
[TZ810N22KOF](#) [T2563NH80TOH](#)