

# SKM100GAL17E4



## SEMITRANS® 2

### IGBT4 Modules

#### SKM100GAL17E4

#### Features

- IGBT4 = 4. generation medium fast trench IGBT (Infineon)
- CAL4 = Soft switching 4. Generation CAL-Diode
- Insulated copper baseplate using DBC Technology (Direct Copper Bonding)
- With integrated Gate resistor
- For switching frequencies up to 8kHz
- UL recognized, file no. E63532

#### Typical Applications\*

- Electronic welders
- DC/DC – converter
- Brake chopper
- Switched reluctance motor

#### Remarks

- Case temperature limited to  $T_c = 125^\circ\text{C}$  max.
- Recommended  $T_{op} = -40 \dots +150^\circ\text{C}$
- Product reliability results valid for  $T_j = 150^\circ\text{C}$

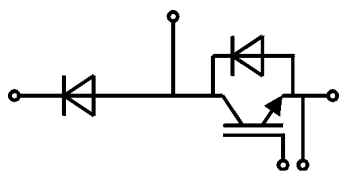

GAL

### Absolute Maximum Ratings

Symbol	Conditions	Values	Unit	
<b>IGBT</b>				
$V_{CES}$	$T_j = 25^\circ\text{C}$	1700	V	
$I_C$	$T_j = 175^\circ\text{C}$	$T_c = 25^\circ\text{C}$	164	A
		$T_c = 80^\circ\text{C}$	127	A
$I_{Cnom}$		100	A	
$I_{CRM}$	$I_{CRM} = 3 \times I_{Cnom}$	300	A	
$V_{GES}$		-20 ... 20	V	
$t_{psc}$	$V_{CC} = 1000\text{ V}$ $V_{GE} \leq 15\text{ V}$ $V_{CES} \leq 1700\text{ V}$	$T_j = 150^\circ\text{C}$	10	$\mu\text{s}$
$T_j$		-40 ... 175	$^\circ\text{C}$	
<b>Inverse diode</b>				
$I_F$	$T_j = 175^\circ\text{C}$	$T_c = 25^\circ\text{C}$	113	A
		$T_c = 80^\circ\text{C}$	83	A
$I_{Fnom}$		100	A	
$I_{FRM}$	$I_{FRM} = 2 \times I_{Fnom}$	200	A	
$I_{FSM}$	$t_p = 10\text{ ms, sin } 180^\circ, T_j = 25^\circ\text{C}$	650	A	
$T_j$		-40 ... 175	$^\circ\text{C}$	
<b>Freewheeling diode</b>				
$I_F$	$T_j = 175^\circ\text{C}$	$T_c = 25^\circ\text{C}$	113	A
		$T_c = 80^\circ\text{C}$	83	A
$I_{Fnom}$		100	A	
$I_{FRM}$	$I_{FRM} = 2 \times I_{Fnom}$	200	A	
$I_{FSM}$	$t_p = 10\text{ ms, sin } 180^\circ, T_j = 25^\circ\text{C}$	650	A	
$T_j$		-40 ... 175	$^\circ\text{C}$	
<b>Module</b>				
$I_{t(RMS)}$		200	A	
$T_{stg}$		-40 ... 125	$^\circ\text{C}$	
$V_{isol}$	AC sinus 50 Hz, $t = 1\text{ min}$	4000	V	

### Characteristics

Symbol	Conditions	min.	typ.	max.	Unit
<b>IGBT</b>					
$V_{CE(sat)}$	$I_C = 100\text{ A}$ $V_{GE} = 15\text{ V}$ chiplevel	$T_j = 25^\circ\text{C}$	1.90	2.20	V
		$T_j = 150^\circ\text{C}$	2.30	2.60	V
$V_{CE0}$	chiplevel	$T_j = 25^\circ\text{C}$	0.8	0.9	V
		$T_j = 150^\circ\text{C}$	0.7	0.8	V
$r_{CE}$	$V_{GE} = 15\text{ V}$ chiplevel	$T_j = 25^\circ\text{C}$	11	13	$\text{m}\Omega$
		$T_j = 150^\circ\text{C}$	16	18	$\text{m}\Omega$
$V_{GE(th)}$	$V_{GE} = V_{CE}, I_C = 4\text{ mA}$	5.2	5.8	6.4	V
$I_{CES}$	$V_{GE} = 0\text{ V}$ $V_{CE} = 1700\text{ V}$	$T_j = 25^\circ\text{C}$		1	$\text{mA}$
		$T_j = 150^\circ\text{C}$			$\text{mA}$
$C_{ies}$	$V_{CE} = 25\text{ V}$		9		$\text{nF}$
$C_{oes}$	$V_{GE} = 0\text{ V}$		0.34		$\text{nF}$
$C_{res}$			0.29		$\text{nF}$
$Q_G$	$V_{GE} = -8\text{ V} \dots +15\text{ V}$		800		$\text{nC}$
$R_{Gint}$	$T_j = 25^\circ\text{C}$		7.5		$\Omega$



**SEMITRANS® 2**

## IGBT4 Modules

### SKM100GAL17E4

#### Features

- IGBT4 = 4. generation medium fast trench IGBT (Infineon)
- CAL4 = Soft switching 4. Generation CAL-Diode
- Insulated copper baseplate using DBC Technology (Direct Copper Bonding)
- With integrated Gate resistor
- For switching frequencies up to 8kHz
- UL recognized, file no. E63532

#### Typical Applications\*

- Electronic welders
- DC/DC – converter
- Brake chopper
- Switched reluctance motor

#### Remarks

- Case temperature limited to  $T_C = 125^\circ\text{C}$  max.
- Recommended  $T_{op} = -40 \dots +150^\circ\text{C}$
- Product reliability results valid for  $T_j = 150^\circ\text{C}$

Characteristics						
Symbol	Conditions		min.	typ.	max.	Unit
$t_{d(on)}$	$V_{CC} = 1200\text{ V}$	$T_j = 150^\circ\text{C}$		234		ns
$t_r$	$I_C = 100\text{ A}$	$T_j = 150^\circ\text{C}$		39		ns
$E_{on}$	$V_{GE} = +15/-15\text{ V}$	$T_j = 150^\circ\text{C}$		43		mJ
$t_{d(off)}$	$R_{G\ on} = 2\ \Omega$	$T_j = 150^\circ\text{C}$		657		ns
$t_f$	$R_{G\ off} = 2\ \Omega$	$T_j = 150^\circ\text{C}$		136		ns
$E_{off}$	$di/dt_{on} = 2540\text{ A}/\mu\text{s}$	$T_j = 150^\circ\text{C}$				
	$di/dt_{off} = 610\text{ A}/\mu\text{s}$			39		mJ
	$du/dt = 5430\text{ V}/\mu\text{s}$					
$R_{th(j-c)}$	per IGBT				0.234	K/W
Inverse diode						
$V_F = V_{EC}$	$I_F = 100\text{ A}$	$T_j = 25^\circ\text{C}$		2.00	2.40	V
	$V_{GE} = 0\text{ V}$	$T_j = 150^\circ\text{C}$		2.15	2.57	V
	chipllevel					
$V_{F0}$		$T_j = 25^\circ\text{C}$		1.32	1.56	V
	chipllevel	$T_j = 150^\circ\text{C}$		1.08	1.22	V
$r_F$		$T_j = 25^\circ\text{C}$		6.8	8.4	m $\Omega$
	chipllevel	$T_j = 150^\circ\text{C}$		11	14	m $\Omega$
$I_{RRM}$	$I_F = 100\text{ A}$	$T_j = 150^\circ\text{C}$		86		A
$Q_{rr}$	$di/dt_{off} = 2360\text{ A}/\mu\text{s}$	$T_j = 150^\circ\text{C}$		34		$\mu\text{C}$
$E_{rr}$	$V_{GE} = -15\text{ V}$	$T_j = 150^\circ\text{C}$		26		mJ
	$V_{CC} = 1200\text{ V}$					
$R_{th(j-c)}$	per diode				0.504	K/W
Freewheeling diode						
$V_F = V_{EC}$	$I_F = 100\text{ A}$	$T_j = 25^\circ\text{C}$		2.00	2.40	V
	$V_{GE} = 0\text{ V}$	$T_j = 150^\circ\text{C}$		2.15	2.57	V
	chipllevel					
$V_{F0}$		$T_j = 25^\circ\text{C}$		1.32	1.56	V
	chipllevel	$T_j = 150^\circ\text{C}$		1.08	1.22	V
$r_F$		$T_j = 25^\circ\text{C}$		6.8	8.4	m $\Omega$
	chipllevel	$T_j = 150^\circ\text{C}$		10.7	13.5	m $\Omega$
$I_{RRM}$	$I_F = 100\text{ A}$	$T_j = 150^\circ\text{C}$		86		A
$Q_{rr}$	$di/dt_{off} = 2360\text{ A}/\mu\text{s}$	$T_j = 150^\circ\text{C}$		34		$\mu\text{C}$
$E_{rr}$	$V_{GE} = \pm 15\text{ V}$	$T_j = 150^\circ\text{C}$		26		mJ
	$V_{CC} = 1200\text{ V}$					
$R_{th(j-c)}$	per Diode				0.504	K/W
Module						
$L_{CE}$				30		nH
$R_{CC'+EE'}$	terminal-chip	$T_C = 25^\circ\text{C}$		0.65		m $\Omega$
		$T_C = 125^\circ\text{C}$		1.09		m $\Omega$
$R_{th(c-s)}$	per module			0.04	0.05	K/W
$M_s$	to heat sink M6			3	5	Nm
$M_t$	to terminals M5			2.5	5	Nm
						Nm
w					160	g

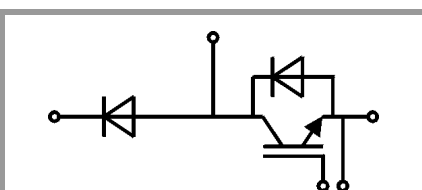

**GAL**

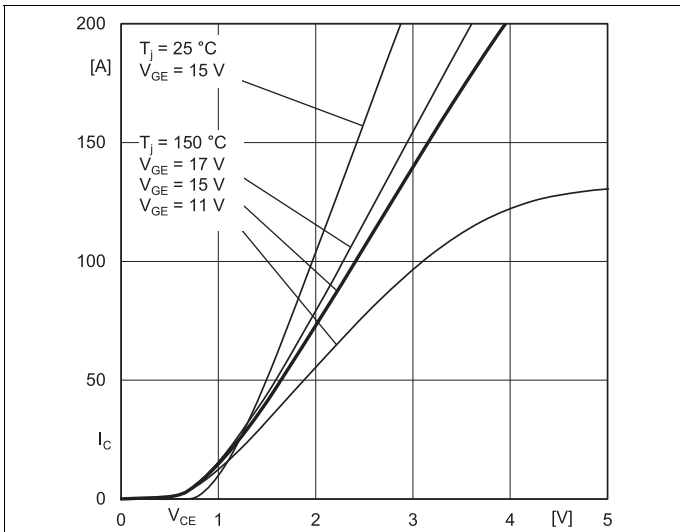

Fig. 1: Typ. output characteristic, inclusive  $R_{CC'+EE'}$

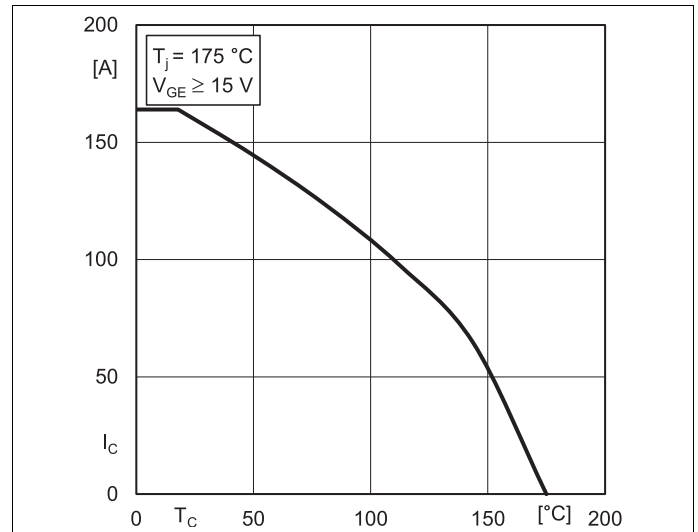

Fig. 2: Rated current vs. temperature  $I_C = f(T_C)$

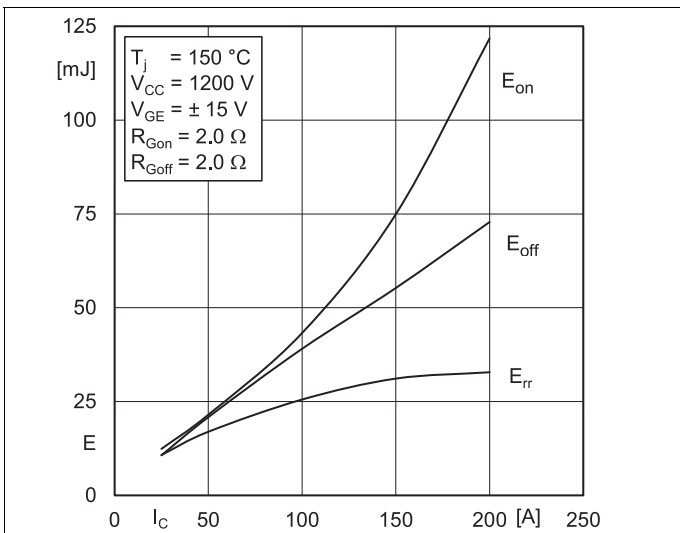

Fig. 3: Typ. turn-on /-off energy =  $f(I_C)$

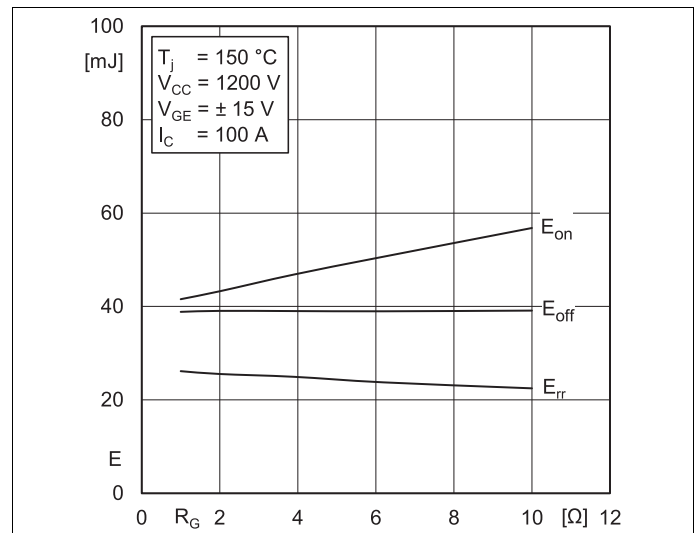

Fig. 4: Typ. turn-on /-off energy =  $f(R_G)$

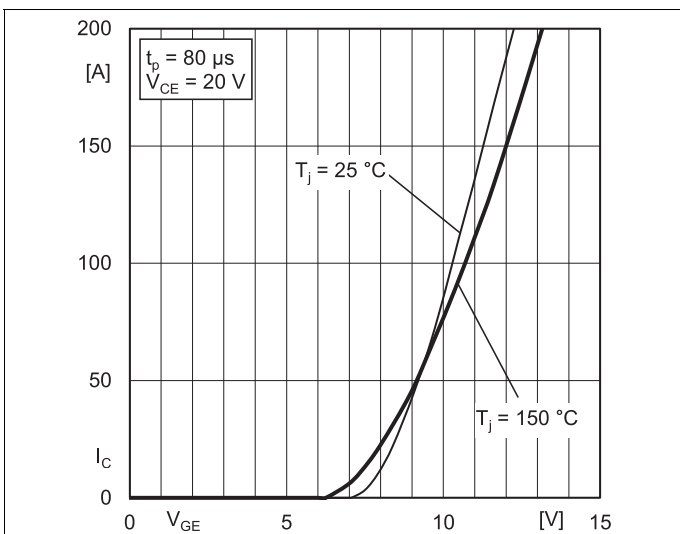

Fig. 5: Typ. transfer characteristic

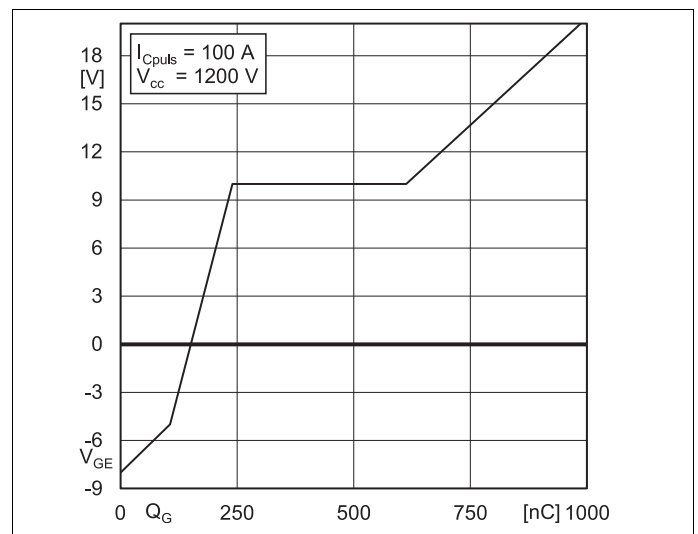

Fig. 6: Typ. gate charge characteristic

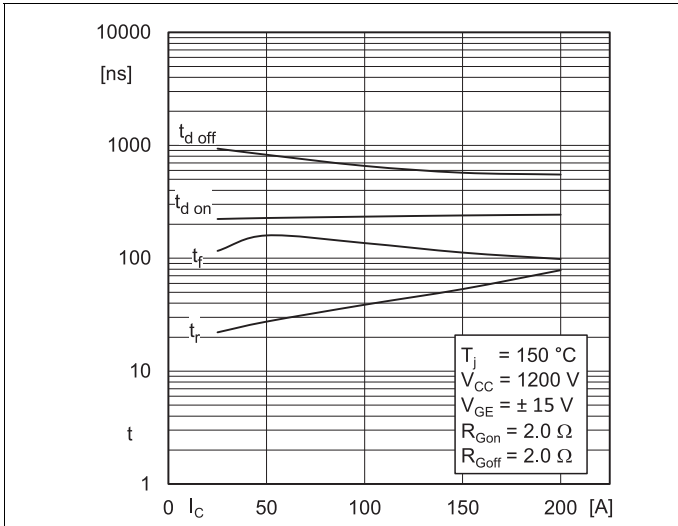

Fig. 7: Typ. switching times vs.  $I_C$

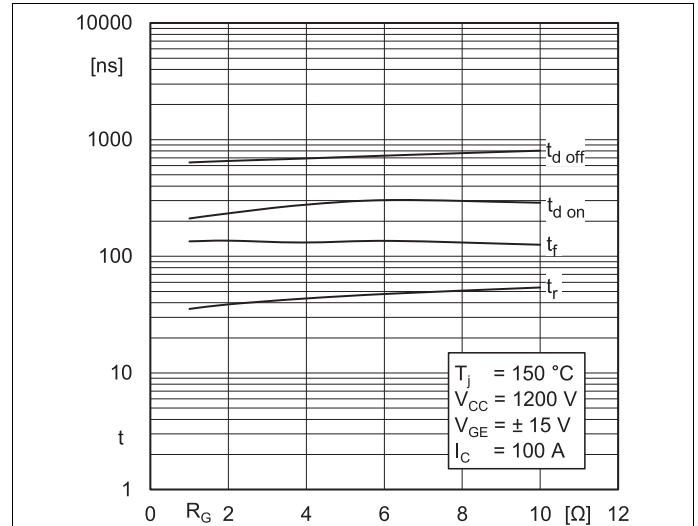

Fig. 8: Typ. switching times vs. gate resistor  $R_G$

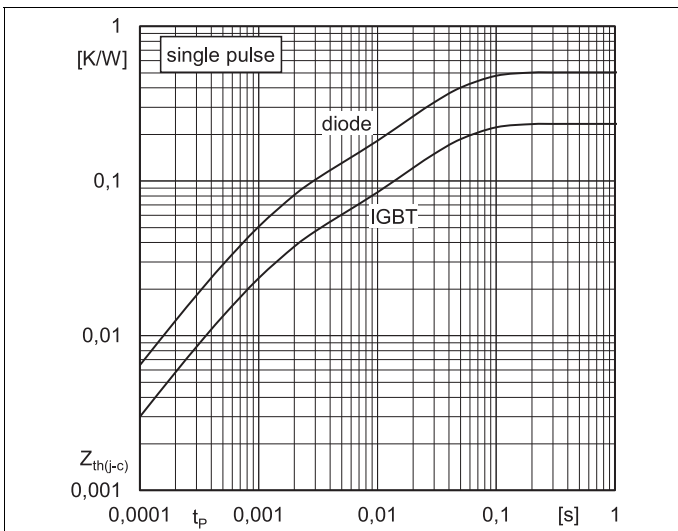

Fig. 9: Transient thermal impedance

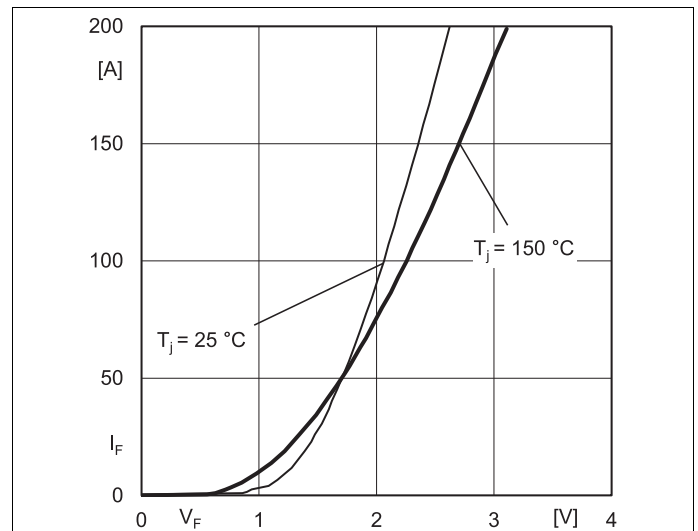

Fig. 10: Typ. CAL diode forward charact., incl.  $R_{CC'+EE'}$

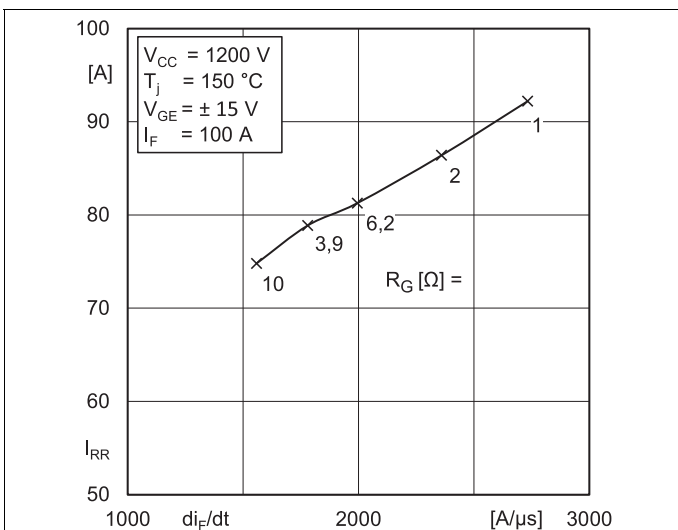

Fig. 11: CAL diode peak reverse recovery current

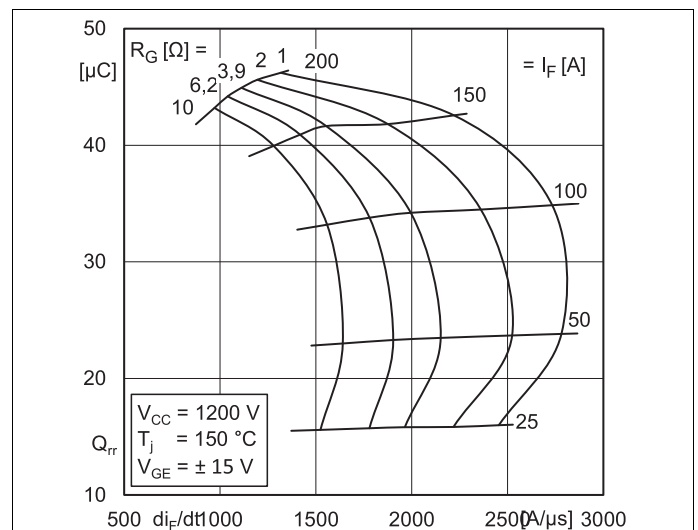
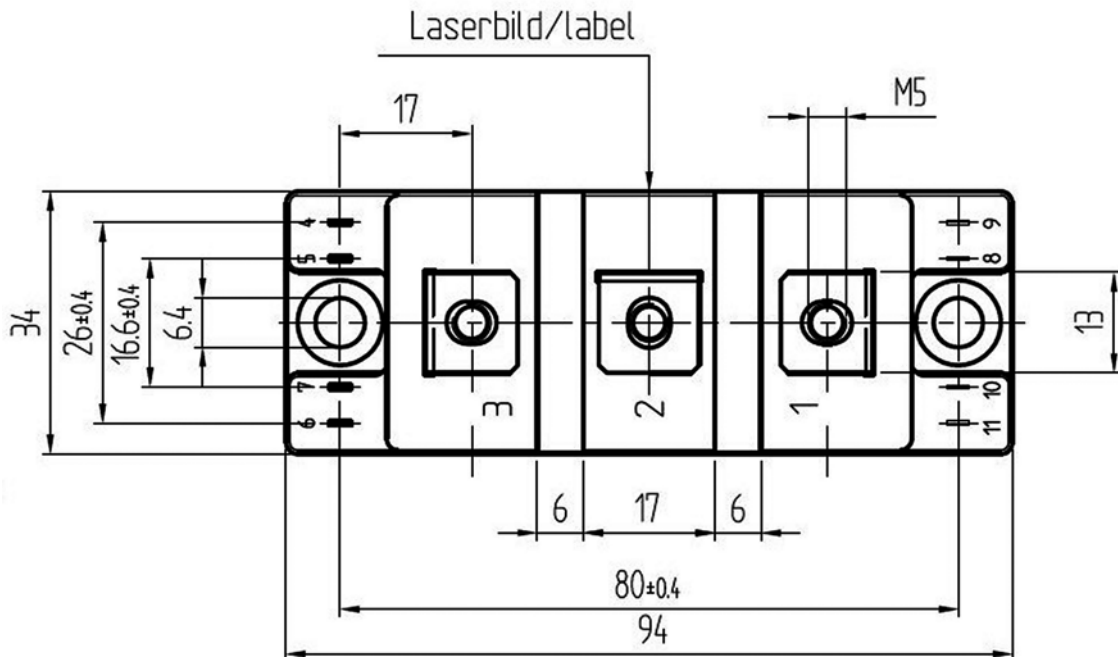
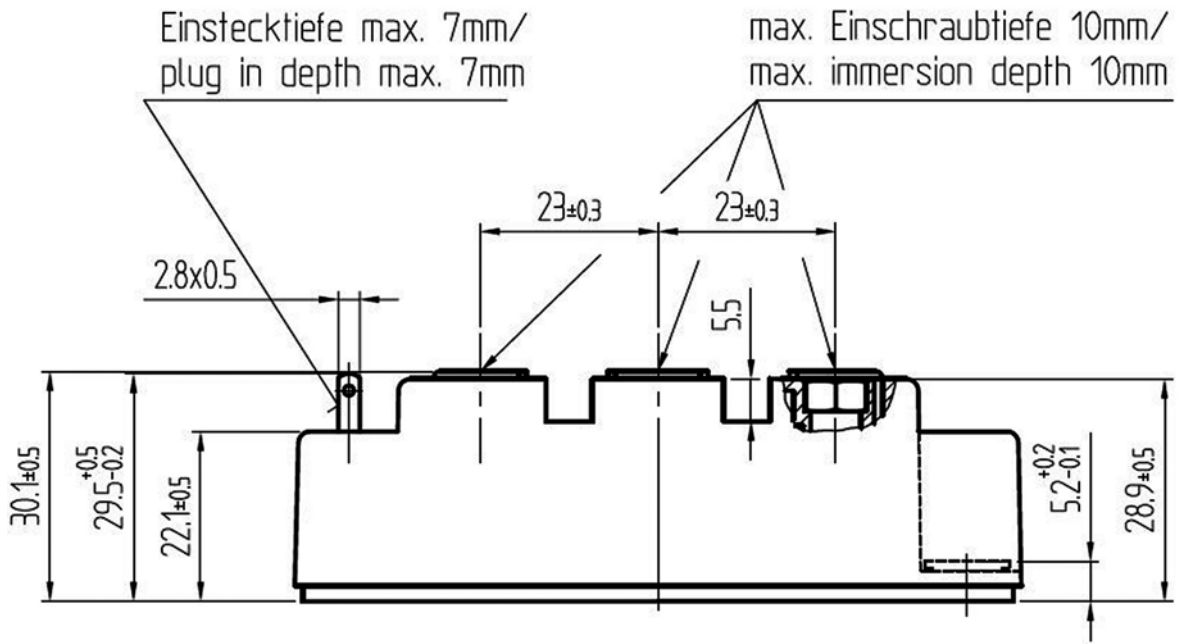
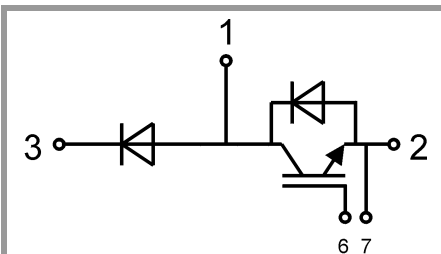

Fig. 12: Typ. CAL diode peak reverse recovery charge

# SKM100GAL17E4



SEMITRANS 2



GAL

This is an electrostatic discharge sensitive device (ESDS), international standard IEC 60747-1, Chapter IX

\* The specifications of our components may not be considered as an assurance of component characteristics. Components have to be tested for the respective application. Adjustments may be necessary. The use of SEMIKRON products in life support appliances and systems is subject to prior specification and written approval by SEMIKRON. We therefore strongly recommend prior consultation of our staff.

## X-ON Electronics

Largest Supplier of Electrical and Electronic Components

*Click to view similar products for [IGBT Modules category](#):*

*Click to view products by [Semikron manufacturer](#):*

Other Similar products are found below :

[F3L100R07W2E3\\_B11](#) [F3L15R12W2H3\\_B27](#) [F3L400R07ME4\\_B22](#) [F3L400R12PT4\\_B26](#) [F4-100R12KS4](#) [F4-50R07W2H3\\_B51](#) [F4-75R12KS4\\_B11](#) [FB15R06W1E3](#) [FB20R06W1E3\\_B11](#) [FD1000R33HE3-K](#) [FD300R06KE3](#) [FD300R12KE3](#) [FD300R12KS4\\_B5](#) [FD400R12KE3](#) [FD400R33KF2C-K](#) [FD401R17KF6C\\_B2](#) [FD-DF80R12W1H3\\_B52](#) [FF100R12KS4](#) [FF1200R17KE3\\_B2](#) [FF150R12KE3G](#) [FF200R06KE3](#) [FF200R06YE3](#) [FF200R12KT3](#) [FF200R12KT3\\_E](#) [FF200R12KT4](#) [FF200R17KE3](#) [FF300R06KE3\\_B2](#) [FF300R12KE4\\_E](#) [FF300R12KS4HOSA1](#) [FF300R12ME4\\_B11](#) [FF300R12MS4](#) [FF300R17ME4](#) [FF450R12ME4P](#) [FF450R17IE4](#) [FF600R12IE4V](#) [FF600R12IP4V](#) [FF800R17KP4\\_B2](#) [FF900R12IE4V](#) [MIXA30W1200TED](#) [MIXA450PF1200TSF](#) [FP06R12W1T4\\_B3](#) [FP100R07N3E4](#) [FP100R07N3E4\\_B11](#) [FP10R06W1E3\\_B11](#) [FP10R12W1T4\\_B11](#) [FP10R12YT3](#) [FP10R12YT3\\_B4](#) [FP150R07N3E4](#) [FP15R12KT3](#) [FP15R12W2T4](#)