

# SKN 141F



**Stud Diode**

## Fast Recovery Rectifier Diode

**SKN 141F**

**SKR 141F**

### Features

- Small recovered charge
- Soft recovery
- Hermetic metal case with glass insulator
- Threaded stud M12
- SKN: anode to stud;  
SKR: cathode to stud

### Typical Applications\*

- Inverse diode for GTO and asymmetric thyristor
- Inverters and choppers
- A.C. motor control
- Uninterruptible power supplies (UPS)

| $V_{RSM}$<br>V | $V_{RRM}$<br>V | $I_{FRMS} = 260$ A (maximum value for continuous operation)<br>$I_{FAV} = 140$ A (sin. 180; 1000 Hz; $T_c = 100$ °C) |            |
|----------------|----------------|--|------------|
| 1200           | 1200           | SKN 141F12   | SKR 141F12 |
| 1400           | 1400           | SKN 141F14   | SKR 141F14 |
| 1500           | 1500           | SKN 141F15   | SKR 141F15 |
| 1700           | 1700           | SKN 141F17   | SKR 141F17 |

| Symbol        | Conditions                              | Values         | Units            |
|---------------|---|----------------|------------------|
| $I_{FAV}$     | sin. 180; $T_c = 85$ (100) °C           | 168 (140)      | A                |
| $I_{FAV}$     | K1,1F; $T_a = 35$ °C; sin. 180; 1000 Hz | 114            | A                |
| $I_{FSM}$     | $T_{vj} = 25$ °C; 10 ms                 | 2500           | A                |
|               | $T_{vj} = 150$ °C; 10 ms                | 2100           | A                |
| $i^2t$        | $T_{vj} = 25$ °C; 8,3 ... 10 ms         | 31000          | A <sup>2</sup> s |
|               | $T_{vj} = 150$ °C; 8,3 ... 10 ms        | 22000          | A <sup>2</sup> s |
| $V_F$         | $T_{vj} = 25$ °C; $I_F = 300$ A         | max. 1,8       | V                |
| $V_{(TO)}$    | $T_{vj} = 150$ °C                       | max. 1,1       | V                |
| $r_T$         | $T_{vj} = 150$ °C                       | max. 2         | mΩ               |
| $I_{RD}$      | $T_{vj} = 25$ °C; $V_{RD} = V_{RRM}$    | max. 1         | mA               |
| $I_{RD}$      | $T_{vj} = 150$ °C; $V_{RD} = V_{RRM}$   | max. 100       | mA               |
| $Q_{rr}$      | $T_{vj} = 150$ °C; $I_F = 100$ A,       | 90             | μC               |
| $I_{RM}$      | $-di/dt = 100$ A/μs, $V_R = 400$ V      | 90             | A                |
| $t_{rr}$      |   | 2000           | ns               |
| $E_{rr}$      |   | -              | mJ               |
| $R_{th(j-c)}$ |   | 0,2            | K/W              |
| $R_{th(c-s)}$ |   | 0,08           | K/W              |
| $T_{vj}$      |   | - 40 ... + 150 | °C               |
| $T_{stg}$     |   | - 55 ... + 150 | °C               |
| $V_{isol}$    |   | -              | V~               |
| $M_s$         | to heatsink                             | 10             | Nm               |
| $a$           |   | 5 * 9,81       | m/s <sup>2</sup> |
| $m$           | approx.                                 | 75             | g                |
| Case          |   | E 31           |                  |

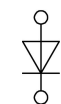

**SKN**

**SKR**

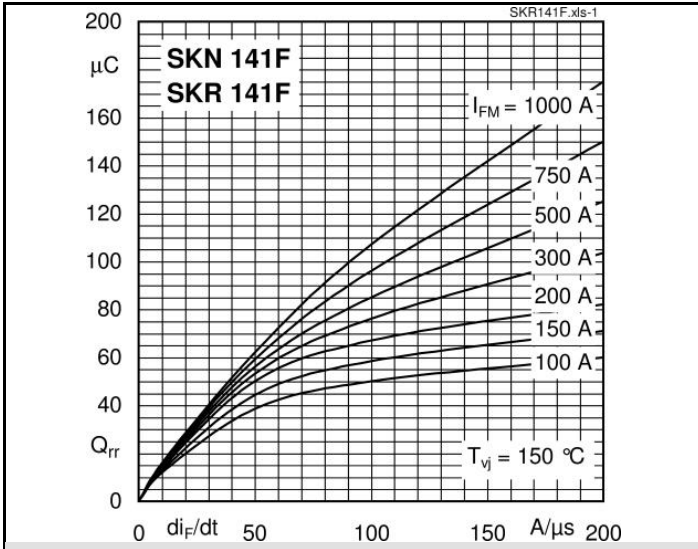

Fig. 1 Typ. recovery charge vs. current decrease

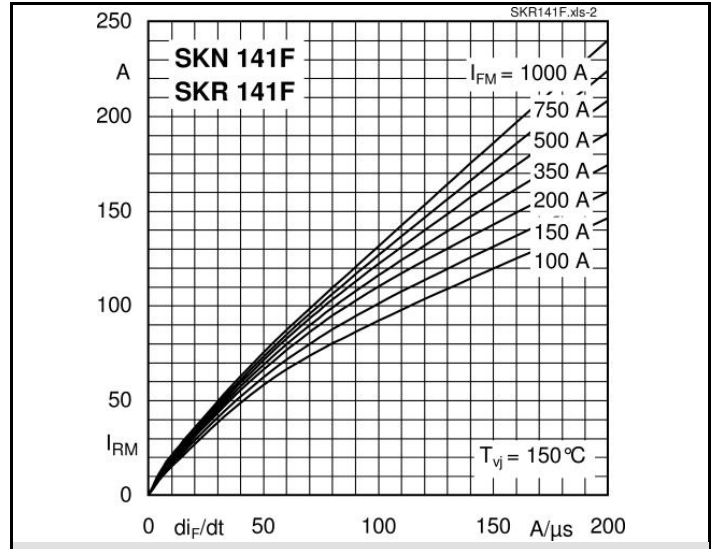

Fig. 2 Peak recovery current vs. current decrease

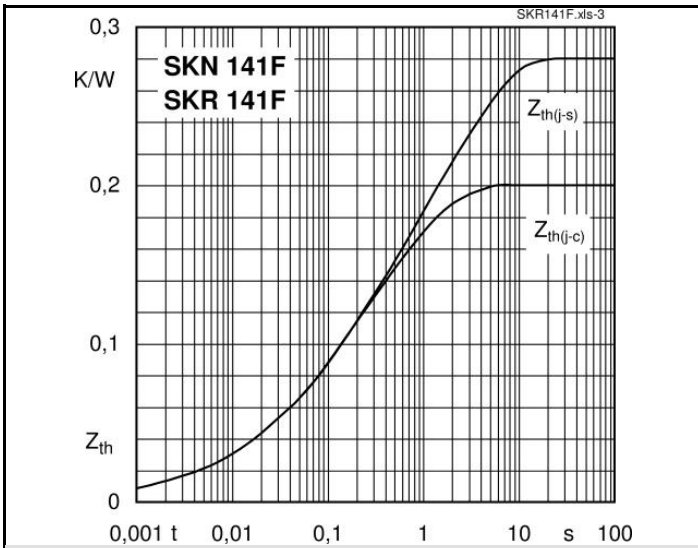

Fig. 3 Transient thermal impedance vs. time

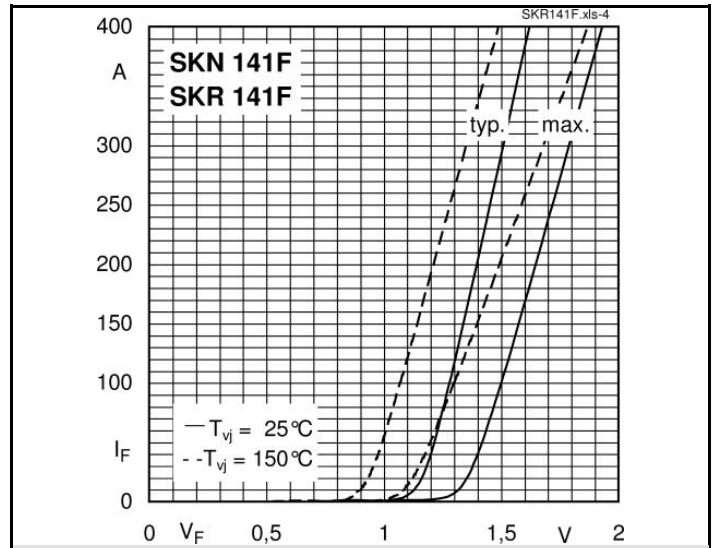

Fig. 4 Forward characteristics

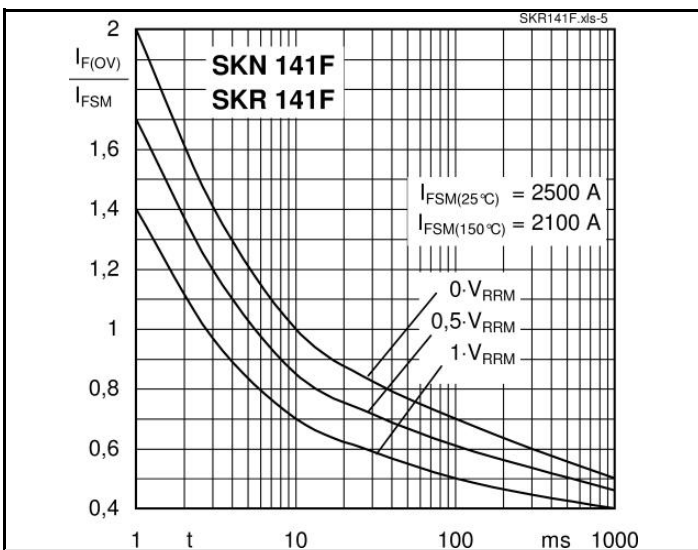
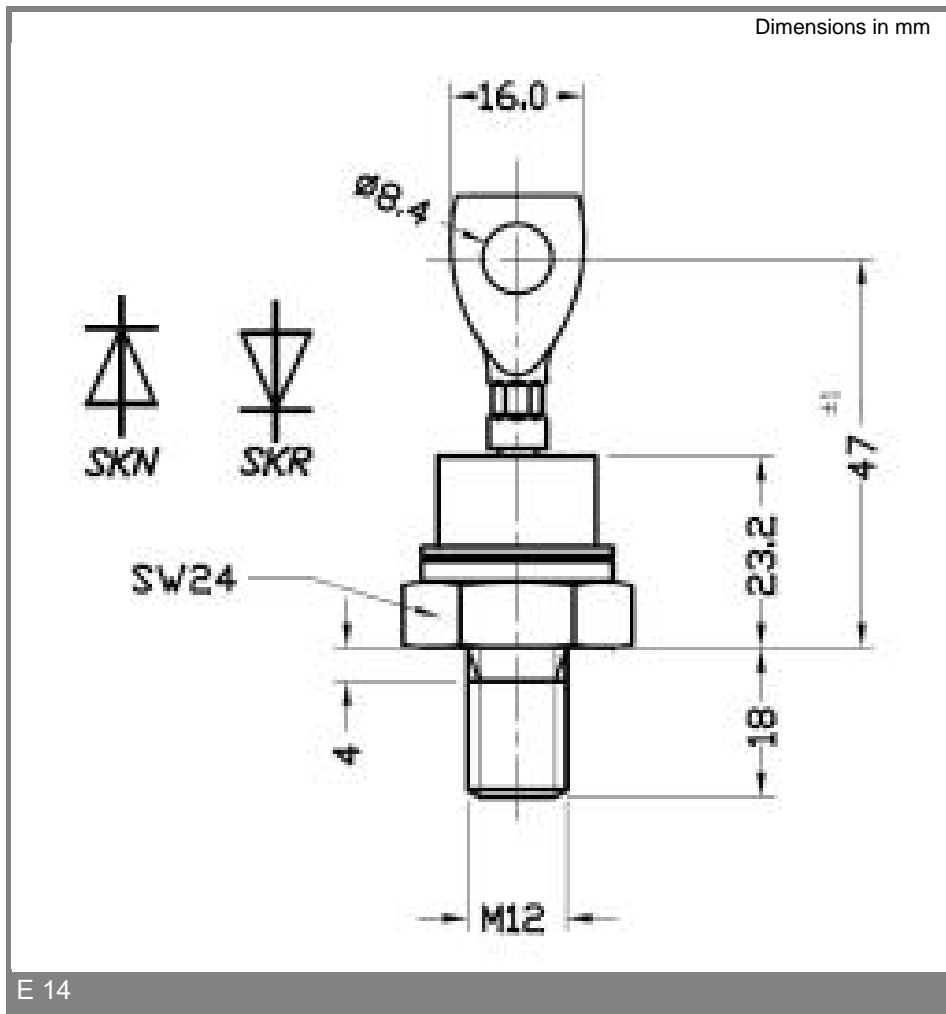

Fig. 5 Surge overload current vs. time

Dimensions in mm



\* The specifications of our components may not be considered as an assurance of component characteristics. Components have to be tested for the respective application. Adjustments may be necessary. The use of SEMIKRON products in life support appliances and systems is subject to prior specification and written approval by SEMIKRON. We therefore strongly recommend prior consultation of our personal.

## X-ON Electronics

Largest Supplier of Electrical and Electronic Components

*Click to view similar products for [Rectifiers](#) category:*

*Click to view products by [Semikron](#) manufacturer:*

Other Similar products are found below :

[D91A](#) [DA24F4100L](#) [DD89N1600K-A](#) [DD89N16K-K](#) [RL252-TP](#) [DLA11C-TR-E](#) [DSA17G](#) [1N4005-TR](#) [BAV199-TP](#) [UFS120Je3/TR13](#)  
[JANS1N6640US](#) [VS-80-1293](#) [DD89N16K](#) [DD89N16K-A](#) [481235F](#) [DSP10G-TR-E](#) [RRE02VS6SGTR](#) [067907F](#) [MS306](#) [ND104N08K](#)  
[SPA2003-B-D-A01](#) [VS-80-6193](#) [VS-66-9903](#) [VGF0136AB](#) [US2JFL-TP](#) [UFS105Je3/TR13](#) [A1N5404G-G](#) [ACGRA4007-HF](#) [ACGRB207-HF](#)  
[RF301B2STL](#) [RF501B2STL](#) [UES1306](#) [UES1302](#) [BAV199E6433HTMA1](#) [ACGRC307-HF](#) [ACEFC304-HF](#) [JANTXV1N5660A](#) [UES1106](#)  
[GS2K-LTP](#) [D126A45C](#) [D251N08B](#) [SCHJ22.5K](#) [SM100](#) [SCPA2](#) [SCH10000](#) [SDHD5K](#) [STTH20P035FP](#) [VS-8EWS12S-M3](#) [VS-](#)  
[12FL100S10](#) [ACGRA4001-HF](#)