

EL CONNECTOR

4.5mm pitch/Disconnectable Crimp style Wire-to-wire connectors

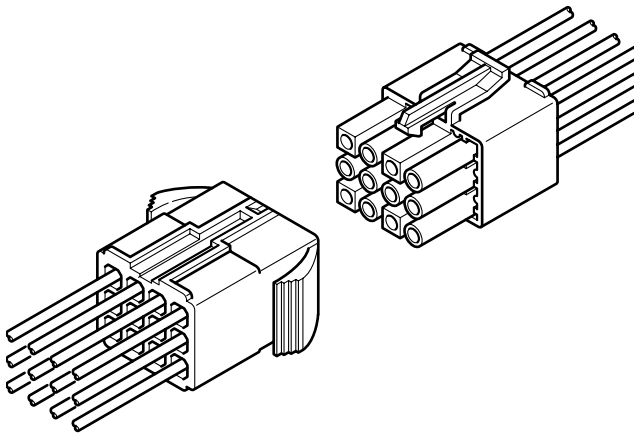

The contacts for the compact EL connector can be easily inserted into the connector housings. The plug housing and the receptacle housing can be smoothly mated even if they are mechanically distorted.

- Easy insertion and secure installation of contacts
- A smooth connection even when pried during mating
- Durable arm lock mechanism
- Two contact styles
- Interchangeability with ML connector

Panel layout and Assembly layout

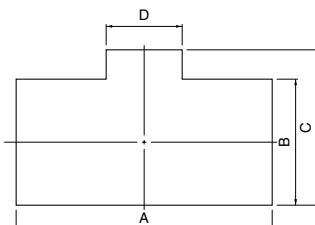
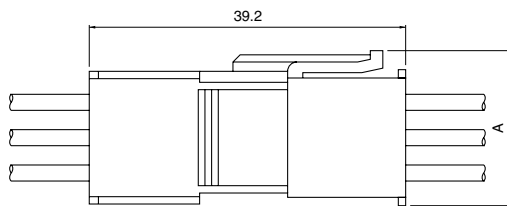

- Note: 1. Punch holes in the panel according to the figures and table shown above. Burrs must be removed.
 2. The strength of the panel must be considered when punching two or more holes.
 3. The connector must be inserted from the same side as the hole is punched.

Specifications

- Current rating: 10A AC, DC max.
- Voltage rating: 300V AC, DC max.
- Temperature range: -25°C to +90°C (including temperature rise in applying electrical current)
- Contact resistance: Initial value/7m Ω max. After environmental testing/10m Ω max.
- Insulation resistance: 1,000M Ω min.
- Withstanding voltage: 1,500V AC/minute
- Applicable wire: AWG #26 to #16 0.13 to 1.25mm²
- Applicable panel thickness: 0.8 to 2.0mm
- * Compliant with RoHS.
- * Refer to "General Instruction and Notice when using Terminals and Connectors" at the end of this catalog.
- * Contact JST for details.

Note: The current rating varies depending on the number of circuits and the wire size used in each connector. The table below lists the current rating as a function of the number of circuits and the wire size.

Current unit : A

| Circuits | Wire size (AWG) | | | | | |
|----------|-----------------|-----|-----|-----|-----|-----|
| | #16 | #18 | #20 | #22 | #24 | #26 |
| 2 | 10 | 6 | 5 | 4 | 4 | 3 |
| 3 | 10 | 6 | 5 | 4 | 4 | 3 |
| 4 | 10 | 6 | 5 | 4 | 4 | 3 |
| 6 | 8 | 5 | 4 | 3 | 3 | 3 |
| 9 | 6 | 4 | 3 | 3 | 2 | 2 |
| 12 | 6 | 4 | 3 | 3 | 2 | 2 |
| 15 | 6 | 4 | 3 | 3 | 2 | 2 |

Standards

Recognized E60389

Certified LR20812

R75052

| Circuits | Dimensions A (mm) |
|----------------------------------|-------------------|
| 2~4 (Single-line arrangement) | 10.4 |
| 4 (Double-line arrangement) | 15.0 |
| 6 | 14.9 |
| 9~15 | 19.4 |

| Circuits | Receptacle housing Model No. | Panel hole dimensions (mm) | | | | Applicable panel thickness (mm) |
|----------|------------------------------|----------------------------|------|------|-----|---------------------------------|
| | | A | B | C | D | |
| 2 | ELR-02V | 15.0 | 6.0 | 6.85 | 5.2 | 0.8~2.0 |
| 3 | ELR-03V | 19.7 | 6.0 | 6.85 | 5.2 | |
| 4 | ELR-04V | 24.2 | 6.0 | 6.85 | 5.2 | |
| | ELR-04NV | 15.6 | 10.6 | 11.6 | 5.2 | |
| 6 | ELR-06V | 19.7 | 10.2 | 11.1 | 5.2 | |
| 9 | ELR-09V | 19.7 | 14.8 | 15.7 | 5.2 | |
| 12 | ELR-12V | 24.2 | 14.8 | 15.7 | 5.2 | |
| 15 | ELR-15V | 28.7 | 14.8 | 15.7 | 5.2 | |

EL CONNECTOR

Contact

Pin contact

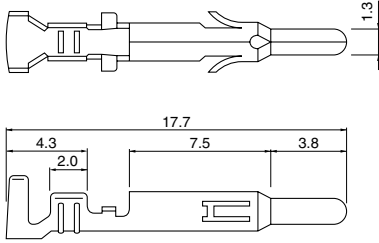

Socket contact

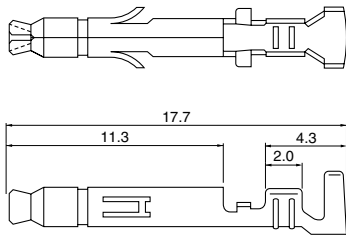

| Model No. | | Applicable wire | | Insulation O.D. (mm) | Q'ty / reel |
|----------------|----------------|---------------------|-----------------|----------------------|-------------|
| Pin contact | Socket contact | mm ² | AWG # | | |
| SLM-01T-P1.3E | SLF-01T-P1.3E | 0.13~0.5 | 26~20 | 1.3~2.7 | 6,000 |
| SLM-41T-P1.3E | SLF-41T-P1.3E | 0.5 ~1.25 | 20~16 | 1.9~3.4 | 4,000 |
| *SLM-42T-P1.3E | *SLF-42T-P1.3E | 0.3+0.3~ 0.5+0.5 | 22+22~ 20+20 | 1.7+1.7~ 2.0+2.0 | |

Material and Finish

Phosphor bronze, tin-plated (reflow treatment)

RoHS compliance

- Note: 1. Contact denoted by * is used for two wires.
 2. Contact JST for special products.
 3. Contact JST for brass products.

| Contact | Crimping machine | Applicator | | |
|---------------|------------------|------------------|-----------------|----------------------------|
| | | Crimp applicator | Dies | Crimp applicator with dies |
| SLM-01T-P1.3E | AP-K2N | MKS-L | MK/SLF/M-01-13E | APLMK SLF/M01-13E |
| SLF-01T-P1.3E | | *MKS-SC | SC/SLF/M-01-13E | APLSC SLF/M01-13E |
| SLM-42T-P1.3E | | MKS-L | MK/SLF/M-42-13E | APLMK SLF/M42-13E |
| SLF-42T-P1.3E | | — | — | — |
| SLM-41T-P1.3E | | MKS-L | MK/SLF/M-41-13E | APLMK SLF/M41-13E |
| SLF-41T-P1.3E | | *MKS-SC | SC/SLF/M-41-13E | APLSC SLF/M41-13E |

Note: *Strip-crimp applicator

Contact position location numbers

Contact position numbers are stamped

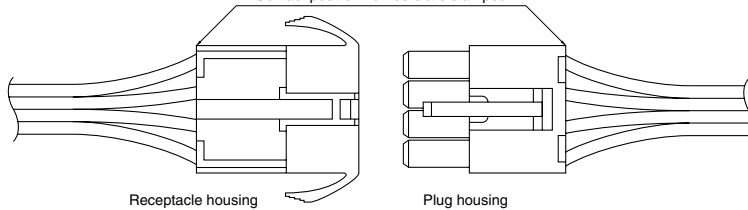

Receptacle housing

Plug housing

Receptacle housing

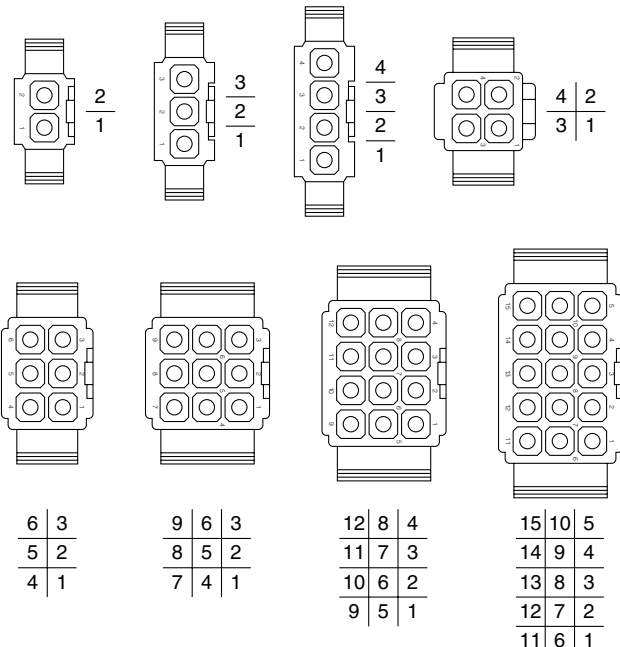

Plug housing

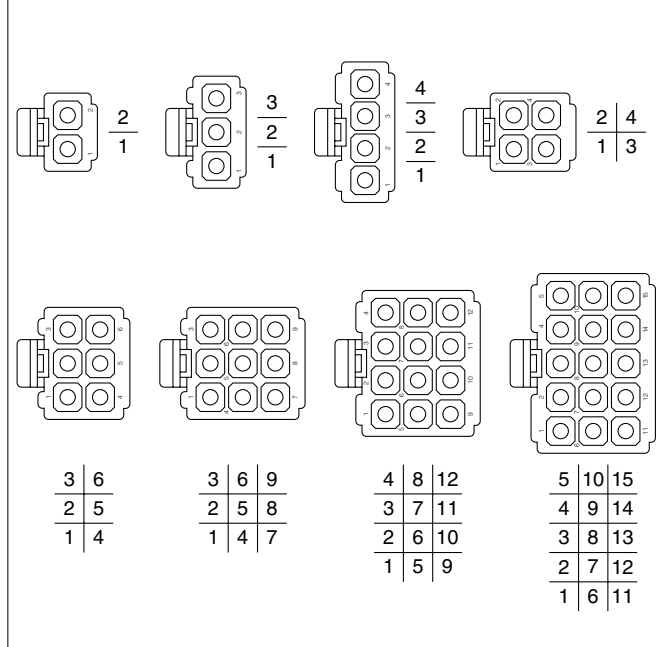

EL CONNECTOR

Housing

Material: PA 6, UL94V-0, white

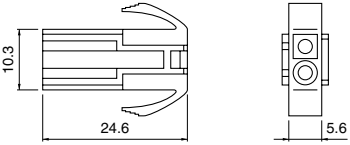
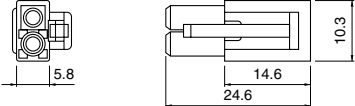
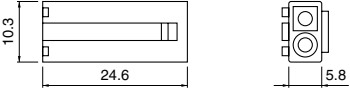
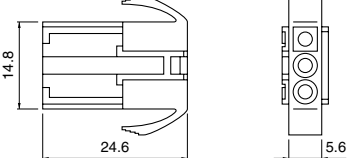
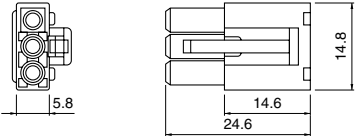
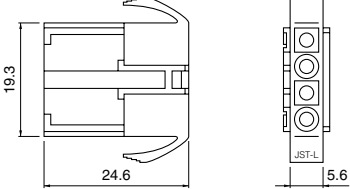
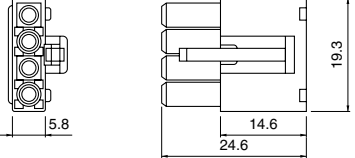
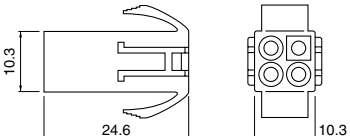
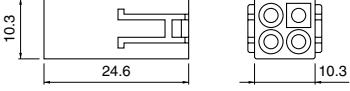
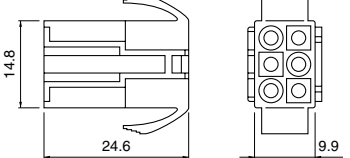
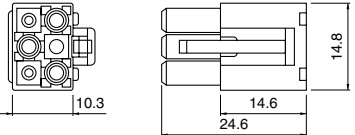
| Circuits | Voltage rating | Current rating | Receptacle housing(for pin contact) | | Plug housing(for socket contact) | |
|----------|----------------|----------------|---|-------------------|---|---|
| 2 | 300V | 10A | ELR-02V  | Q'ty / bag 500 | ELP-02V  | Q'ty / bag 500 |
| | | | ELR-02VF  | Q'ty / bag 500 | | |
| 3 | 300V | 10A | ELR-03V  | Q'ty / bag 500 | ELP-03V  | Q'ty / bag 500 |
| 4 | 300V | 10A | ELR-04V  | Q'ty / bag 500 | | ELP-04V  |
| | | | ELR-04NV  | Q'ty / bag 500 | | |
| | | | ELR-04NVF  | | | |
| 6 | 300V | 8A | ELR-06V  | Q'ty / bag 500 | ELP-06V  | Q'ty / bag 500 |

RoHS compliance

EL CONNECTOR

Housing

Material: PA 6, UL94V-0, white

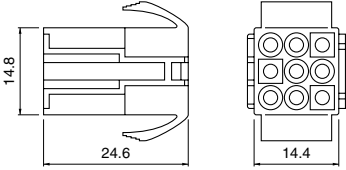
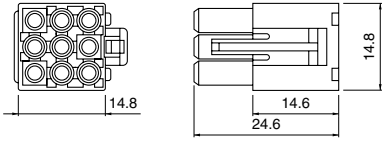
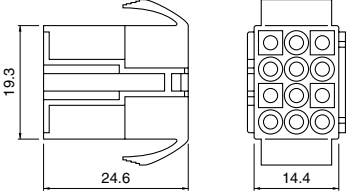
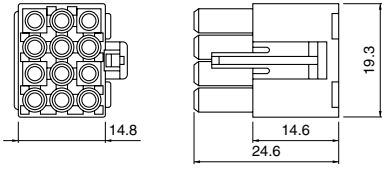
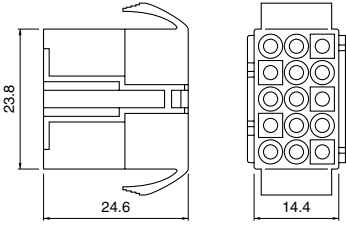
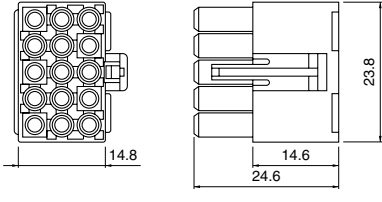
| Circuits | Voltage rating | Current rating | Receptacle housing(for pin contact) | | Plug housing(for socket contact) | |
|----------|----------------|----------------|---|-------------------|--|-------------------|
| 9 | 300V | 6A | ELR-09V  | Q'ty / bag 500 | ELP-09V  | Q'ty / bag 500 |
| 12 | 300V | 6A | ELR-12V  | Q'ty / bag 500 | ELP-12V  | Q'ty / bag 500 |
| 15 | 300V | 6A | ELR-15V  | Q'ty / bag 500 | ELP-15V  | Q'ty / bag 500 |

RoHS compliance

Note: 1. ELR-02VF and ELR-04NVF are exclusively for free hanging. The other circuits can be used either for panel mounted or free hanging.

See "Panel layout" for the panel hole dimensions.

2. Contact JST for special products.

X-ON Electronics

Largest Supplier of Electrical and Electronic Components

Click to view similar products for [Terminals](#) category:

Click to view products by [JST](#) manufacturer:

Other Similar products are found below :

[HT-13-10](#) [71M-250-32-NB](#) [01-2065-1-0216](#) [00581P0075](#) [M10-10RX](#) [M10BCK](#) [60205-1](#) [604200-1](#) [60598-1-CUT-TAPE](#) [60617-1-C](#) [60873-1](#) [M14-516R/SK](#) [M14-6RSX](#) [M18-10FLX](#) [M18-8FBX](#) [M18-8R/LX](#) [M18BCK](#) [61314-6-C](#) [61-S](#) [61-SN-A](#) [62-NBM-A](#) [63-S](#) [640179-1](#) [640917-2-CUT-TAPE](#) [6501550002](#) [66107-2-C](#) [66107-4-C](#) [696683-1](#) [696834-1](#) [696861-1](#) [696931-1](#) [696999-1](#) [M8-516RK](#) [M86700006](#) [MA250DMFMX-A](#) [701-2007](#) [701-2307](#) [701-7761-03](#) [70F-110-32-PB](#) [718-N-A](#) [71M-187-20-NBL](#) [71M-250-32-NBL](#) [72F-187-20-NBL](#) [72M-250-32-NBL](#) [7310](#) [73F-250-32](#) [73F-250-32-NBL](#) [73F-250-32-NL](#) [F14-10C](#) [F-1M](#)