

Quick Mating

Range overview

SMS...PDH1/SMS...PDH3
Cable plug with strain relief hood



SMS...P1/SMS...PD3
Cable plug without strain relief hood



SMS...RDH1/SMS...RDH3
Cable receptacle with strain relief hood

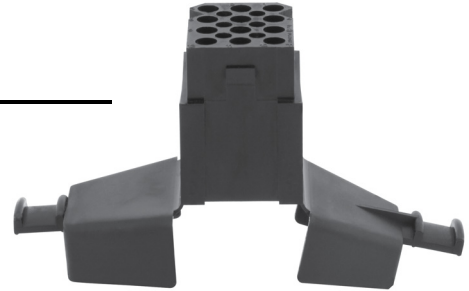

SMS...GE3-GE4/SMS...SE3-SE4
SMS...GE33/SMS...GE43
Straight board mount



SMS...GE5-SE5/SMS...GE6-SE6
SMS...GE53/SMS...GE63
Right angle board mount



SMS...R1/ SMS...R3
Panel mount receptacle



SMS...RD3
Cable receptacle without strain relief hood



Contacts layout

SMS 2

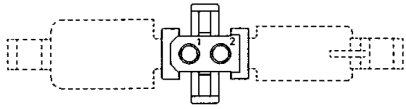

SMS 3

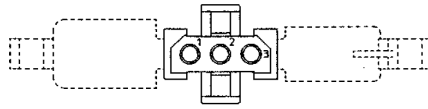

SMS 4

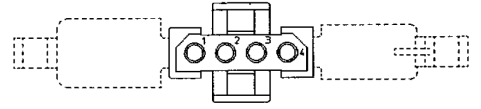

SMS 6

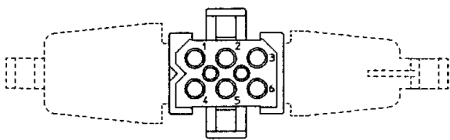

SMS 9

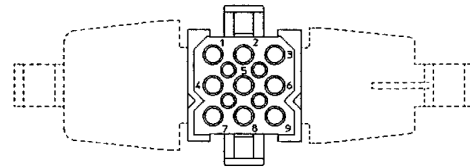

SMS 12

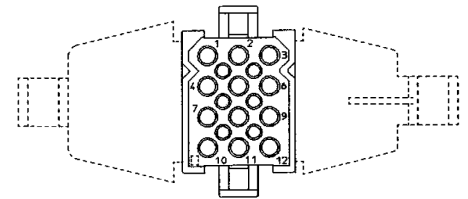

SMS 15

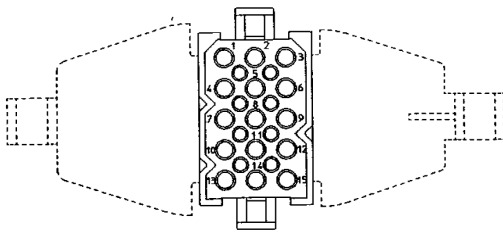

SMS 18

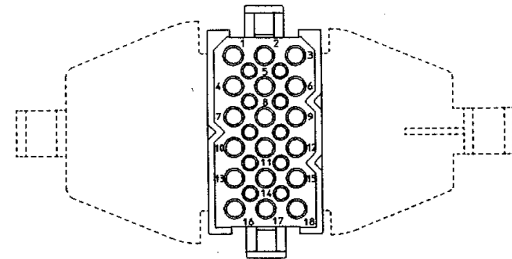

SMS 24

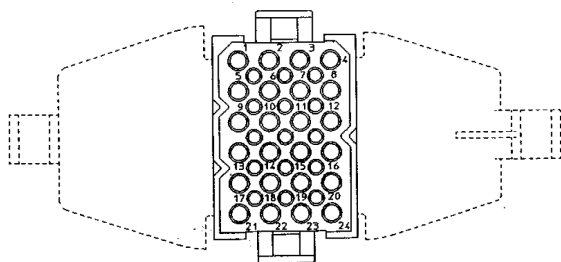

SMS 36

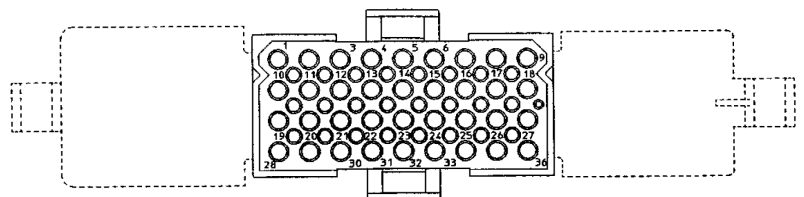

Contact identifications shown are for mating face. Contact identifications of wiring face are identical as shown on the receptacle arrangements

Quick Mating panel and cable connectors

Description

The versatile and easy to use “SMS” Quick Mating panel and cable connectors are a highly cost-effective system approach to solving the constant demand for more interconnection solutions and techniques.

A full plastic solution offered in either Wire attachment or PCB mounting options to provide rapid assembly/installation without requiring additional mounting hardware. Panel receptacle connectors simply snap and lock into panel cut-outs and cable plugs quickly connect and disconnect with positive retention locks. Just push to mate then press and release to un-mate.

In addition, cable plug connectors also feature pin-protection skirts, positive polarization and are offered with or without integrated strain relief hoods. Cable receptacle connectors (with integrated strain relief hoods) are available to mate with the cable plug connectors for cable-to-cable solutions when needed.

These multi-way connectors accept the Size 16 TRIM TRIO (1.6mm) diameter contacts and are available with 10 contact arrangements from 2 to 36 positions.

Features and benefits

- Available in 10 contact arrangements
- Self mountable panel receptacle with positive housing retention
- Cable plugs with retaining latches for positive locking
- Cable plug has pin protection skirt to prevent damage of male contacts
- Positive polarization keys prevent mismatching
- Cable plug and receptacle have integrated strain relief hood which can accept a wide range of cables
- Cable plug and receptacle have discrimination cavities in between contact cavities, thus offering discrimination without contact loss. See instruction page 21.
- UL recognized File Nr.: E238675
- CSA certified File Nr.: LR44961-21

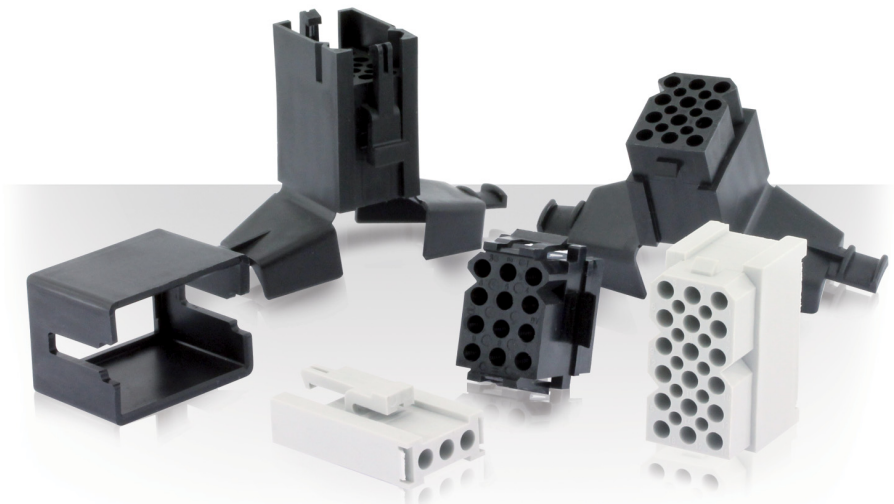

Environmental

- Operating temperature: -55°C to +105°C
- Insulation resistance: 5000 MΩ min.
- Test potential: 2000 VAC
- Durability: 500 matings and unmatings
- Sealing performances: IP40
- Electrical performances:
UL: 250V - 10A
CSA: 250V - 15A

Wire insulation acceptance

- SMS PDH1, RDH1, PD3, PDH3, RD3, RDH3 max: 3.2mm
- SMS R1, P1, R3 max: 4.19mm

Material

- Connector: Polyamide 6.6
 - Flammability rating: UL94 V2 (Black) or UL94 V0 (White).
- The white version is also I3F2/I2F3 according to the NFF 16101 /16102 (Fire & fume standard for French rail market) and R23/HL3 following EN 45 545

Contact

- “SMS” Quick Mating connectors accept TRIM TRIO size 16 removable snap-lock contacts (see contact section)
- Contacts to be ordered separately.

Ordering information

Connector family	SMS	12	PDH3
Layout: see next page			
Body variation:			
R1: (UL94 V2) Panel mount receptacle - Black			
R3: (UL94 V0) Panel mount receptacle - White			
P1: (UL94 V2) Cable plug without strain relief hood - Black			
PD3: (UL94 V0) Cable plug without strain relief hood - White			
PDH1: (UL94 V2) Cable plug with integrated strain relief hood - Black			
PDH3: (UL94 V0) Cable plug with integrated strain relief hood - White			
RD3: (UL94 V0) Cable receptacle without integrated strain relief hood - White			
RDH1: (UL94 V2) Cable receptacle with integrated strain relief hood - Black			
RDH3: (UL94 V0) Cable receptacle with integrated strain relief hood - White			

Connectors

Panel mount receptacle without discrimination cavities (wire acceptance: 4.19mm)

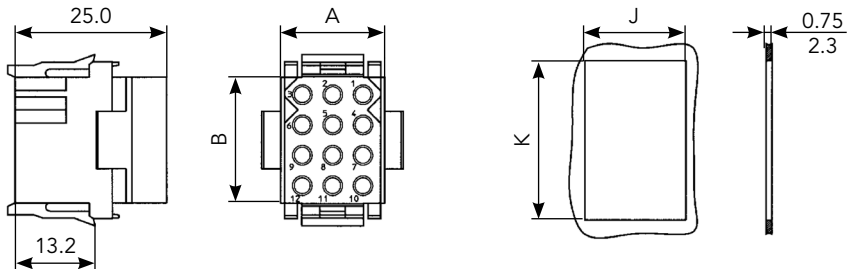
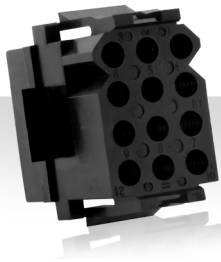

Part number		Nbr. of contact*	A	B	C max.	J	K
Black UL94 V2	White UL94 V0						
SMS2R1	SMS2R3	2	11.0	5.8	15.2	11.4	11.6
SMS3R1	SMS3R3	3	16.2			16.5	
SMS4R1	SMS4R3	4	21.1			21.7	
SMS6R1	SMS6R3	6	16.2	10.9	20.3	16.5	16.7
SMS9R1	SMS9R3	9		16.0	25.4		21.6
SMS12R1	SMS12R3	12		21.1	30.5	16.7	26.7
SMS15R1	SMS15R3	15		26.2	35.6		31.8
SMS18R1	SMS18R3	18	21.2	31.2	40.6	21.7	36.9
SMS24R1	SMS24R3	24					
SMS36R1	SMS36R3	36	46.6	21.1	30.5	47.1	26.7

*Contacts supplied separately

Cable plug without strain relief hood & without discrimination cavities (wire acceptance: 4.19mm)

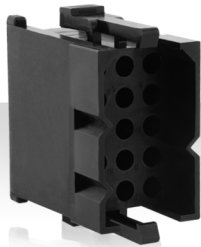

Part number		Nbr. of contact*	A	C max.
Black UL94 V2				
SMS2P1		2	15.0	17.8
SMS3P1		3	18.6	
SMS4P1		4	23.7	
SMS6P1		6	18.6	22.9
SMS9P1		9		27.9
SMS12P1		12		33.0
SMS15P1		15		38.1
SMS18P1		18	23.7	43.2
SMS24P1		24		
SMS36P1		36	49.1	33.0

*Contacts supplied separately

Note: all dimensions are in mm

Cable receptacle without strain relief hood & with discrimination cavities

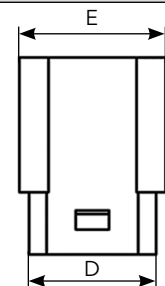
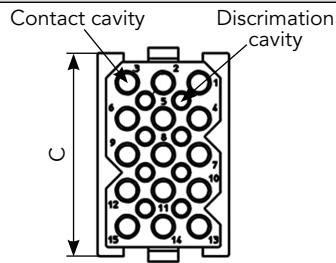
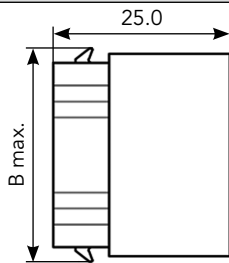
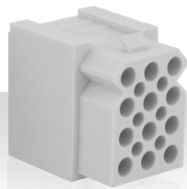

Part number	Nbr. of contact*	Nbr. of discrimination cavities	B max	C	D	E		
White UL94 V0								
SMS2RD3	2	0	9.9	8.4	11.1	14.1		
SMS3RD3	3	0			16.2	18.6		
SMS4RD3	4	0			21.2	23.7		
SMS6RD3	6	2	15.0	13.4	16.2	18.6		
SMS9RD3	9	4	20.0	18.5				
SMS12RD3	12	6	25.1	23.6				
SMS15RD3	15	8	30.2	28.7				
SMS18RD3	18	10	35.3	33.8			21.2	23.7
SMS24RD3	24	15						
SMS36RD3	36	24	25.1	23.6	46.6	49.1		

*Contacts supplied separately

Cable plug without strain relief hood & with discrimination cavities

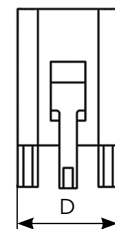
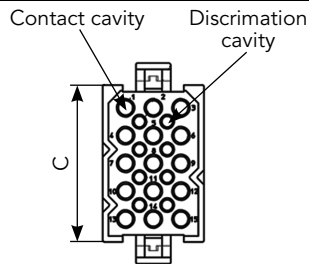
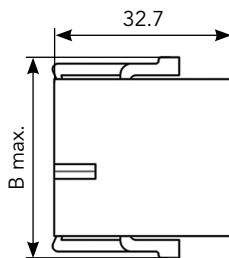

Part number	Nbr. of contact*	Nbr. of discrimination cavities	B max.	C	D	
White UL94 V0						
SMS2PD3	2	0	16.4	8.4	14.1	
SMS3PD3	3	0			18.6	
SMS4PD3	4	0			23.7	
SMS6PD3	6	2	21.5	13.4	18.6	
SMS9PD3	9	4	26.7	18.5		
SMS12PD3	12	6	31.7	23.6		
SMS15PD3	15	8	36.7	28.7		
SMS18PD3	18	10	41.8	33.8		23.7
SMS24PD3	24	15				
SMS36PD3	36	24	31.7	23.6	49.1	

*Contacts supplied separately

Note: all dimensions are in mm

Connectors (Continued)

Cable receptacle with integrated strain relief hood

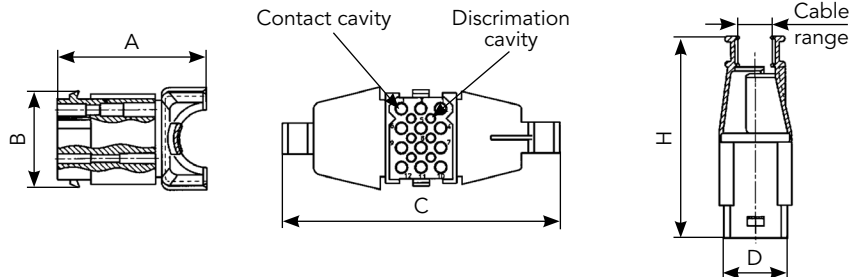

Part number		Nbr. of contact*	Nbr. of discrimination cavities	A	B	C	D	H	Cable range (mm)	Cable tie ⁽¹⁾
Black UL94 V2	White UL94 V0									
SMS2RDH1	SMS2RDH3	2	0	31.6	9.9	11.1	0.5	49.2	0.5-8.4	TF4D
SMS3RDH1	SMS3RDH3	3	0	35.1		69.0	16.2		0.8-7.3	
SMS4RDH1	SMS4RDH3	4	0	38.2		74.4	21.2		1.5-10	
SMS6RDH1	SMS6RDH3	6	2	34.6	15.0	72.6	16.2	50.9	1.7-9.2	TF5D
SMS9RDH1	SMS9RDH3	9	4	35.8	20.0	75.3		52.2	3.9-14.2	
SMS12RDH1	SMS12RDH3	12	6	38.1	25.1	72.0		52.7	4.0-15.0	
SMS15RDH1	SMS15RDH3	15	8	35.9	30.2	81.3	55.2	5.0-16.2	TF5D	
SMS18RDH1	SMS18RDH3	18	10	36.1	35.3			5.8-20.3		
SMS24RDH1	SMS24RDH3	24	15	39.7	90.4			21.2		57.2
SMS36RDH1	SMS36RDH3	36	24	54.6	25.1	128.0	46.6	63.3	8.8-24.5	

*Contacts supplied separately (1) Cable tie not included

Cable plug with integrated strain relief hood

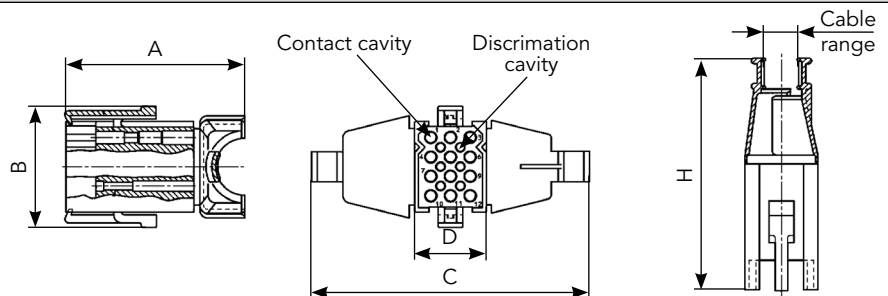

Part number		Nbr. of contact*	Nbr. of discrimination cavities	A	B	C	D	H	Cable range (mm)	Cable tie ⁽¹⁾
Black UL94 V2	White UL94 V0									
SMS2PDH1	SMS2PDH3	2	0	39.5	16.4	64.8	14.1	57.1	0.5-8.4	TF4D
SMS3PDH1	SMS3PDH3	3	0	43.0		69.0	18.6		0.8-7.3	
SMS4PDH1	SMS4PDH3	4	0	46.1		74.4	23.7		1.5-10	
SMS6PDH1	SMS6PDH3	6	2	42.5	21.5	72.6	18.6	58.8	1.7-9.2	TF5D
SMS9PDH1	SMS9PDH3	9	4	43.7	26.7	75.3		60.1	3.9-14.2	
SMS12PDH1	SMS12PDH3	12	6	46.0	31.7	72.0		60.6	4.0-15.0	
SMS15PRDH1	SMS15PDH3	15	8	43.8	36.7	81.3	63.1	5.0-16.2	TF5D	
SMS18PDH1	SMS18PDH3	18	10	44.0	41.8			5.8-20.3		
SMS24PDH1	SMS24PDH3	24	15	47.6	90.4			23.7		65.1
SMS36PDH1	SMS36PDH3	36	24	62.5	31.7	128.0	49.1	71.2	8.8-24.5	

*Contacts supplied separately (1) Cable tie not included

Note: all dimensions are in mm

Accessories for standard Quick Mating connectors

Pin protection shroud for panel mount receptacle

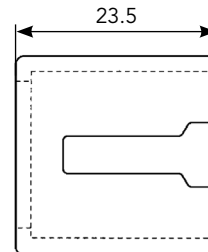
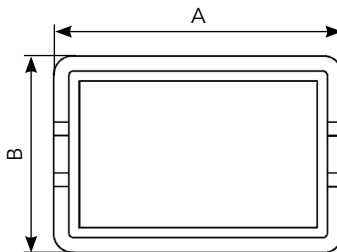

When pins are inserted into the panel mount receptacle half (SMS...R1) of the Quick Mating connector, an optional pin protection shroud can be installed.

The shroud is mounted at the same time as the receptacle by holding the shroud against the mating side of the panel with both cut-outs lined up. The receptacle is then inserted in place, trapping the shroud between the receptacle and panel. The use of the pin protection shroud reduces the allowable thickness of the panel from 2.3 to 1.6 mm max.

Part number	Nbr. of contact position	A	B
Black UL94 V2			
SMS2CSB1	2	19.8	18.8
SMS3CSB1	3	23.4	
SMS4CSB1	4	28.4	
SMS6CSB1	6	23.4	23.9
SMS9CSB1	9		29.0
SMS12CSB1	12		34.0
SMS15CSB1	15		39.1
SMS18CSB1	18		44.2
SMS24CSB1	24	28.4	34.0
SMS36CSB1	36	54.1	

Strain relief hoods



For SMS2H1, SMS3H1, SMS4H1 & SMS6H1



2 pieces are needed for a complete hood for SMS9H1 to SMS36H1

Separate strain relief hoods are available for all standard plugs SMS...P1. The hoods consist of identical halves that snap into position on the plug and are secured in place with the cable tie drawn tightly around the cable entry collar.

The cable tie is not included (TF4D – TF5D).

Two, three and four position hoods are single piece units.

Part number	Nbr. of contact position
Black UL94 V2	
SMS2H1	2
SMS3H1	3
SMS4H1	4
SMS6H1	6
SMS9H1	9
SMS12H1	12
SMS15H1	15
SMS18H1	18
SMS24H1	24
SMS36H1	36

Discrimination pins

For discrimination pins on both standard Quick Mating and Quick Mating Pin Headers cable and board mount:
See accessories section.

Contact Selector Guide

Contact supplied separately

Electrical characteristics: contact resistance		
#16 Ø1.6mm	Machined	< 3mΩ
	Stamped & Formed	< 6mΩ

Available platings (contact supplied separately)	
J	Gold flash over 2µ Ni
K	Min 0.4µ gold over 2µ Ni
S31	Active part: Gold flash over Ni Crimp area: Nickel
S18	Active part: 0.75µ gold min over 2µ Ni Crimp area: 1.3µ tin over Ni Other: Nickel
TK6	2-5µ Sn pre-plated
D70	Superseded by S31
S6	Superseded by S18
Other platings on request (contact supplied separately)	
T	T: 2µm Ni mini all over + 3 to 5 µm Sn all over
D28	0.75µ gold over Ni

Packaging

Due to the wide variety of applications, contact packaging is offered for small series (bulk package) and high volume production (reeled contacts):

Size contacts #16 (Ø1.6mm)



- 25 pieces loose package (Stamped & Formed contacts)



- 50 pieces bulk package (Machined contacts)



- 1,000 pieces bulk package (Machined contacts)



- 3,000 pieces reeled (Stamped & Formed contacts)

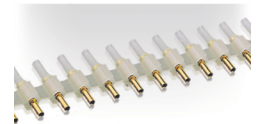

- 2,000 pieces reeled (Machined contacts)

Crimp Contacts

Standard Version



Contact size	Type	Wire size		Part number		Max wire Ø	Max insulator Ø	Available plating
		AWG	mm ²	Male	Female			
#16 Ø1.6 mm	Machined	30-28	0.05-0.08	RM28M1-	RC28M1-	0.55	1.1	K, J
	Machined	26-24	0.13-0.2	RM24M9-	RC24M9-	0.8	1.6	K, J
	Stamped & Formed	26-24	0.13-0.25	SM24M1- ⁽¹⁾ SM24ML1- ⁽²⁾	SC24M1- ⁽¹⁾ SC24ML1- ⁽²⁾	0.89-1.28	Insulation grip	S31, S18, TK6
	Machined	22-20	0.32-0.52	RM20M13- RM20M12-	RC20M13- RC20M12-	1.18	1.8 2.2	K, J
	Stamped & Formed	22-20	0.35-0.5	SM20M1- ⁽¹⁾ SM20ML1- ⁽²⁾	SC20M1- ⁽¹⁾ SC20ML1- ⁽²⁾	1.17-2.08	Insulation grip	S31, S18, TK6
	Machined	20-16	0.52-1.5	RM16M23-	RC16M23-	1.8	3.2	K, J
	Stamped & Formed	18-16	0.8-1.5	SM16M1- ⁽¹⁾ SM16ML1- ⁽²⁾	SC16M1- ⁽¹⁾ SC16ML1- ⁽²⁾	3.0	No insulation grip	S31, S18, TK6
	Stamped & Formed	18-16	0.8-1.5	SM16M11- ⁽¹⁾ SM16ML11- ⁽²⁾	SC16M11- ⁽¹⁾ SC16ML11- ⁽²⁾	2.0-3.0	Insulation grip	S31, S18, TK6
	Machined	16-14	1.5-2.5	RM14M30-	RC14M30-	2.28	3.2	K, J
	Stamped & Formed	14	2.0-2.5	SM14M1- ⁽¹⁾ SM14ML1- ⁽²⁾	SC14M1- ⁽¹⁾ SC14ML1- ⁽²⁾	3.2	No insulation grip	S31, S18, TK6

(1) contact reeled (2) loose contact
Example: RM20M13K - Size #16, Machined, AWG20 wire.

Note: all dimensions are in mm

Tooling

Crimp Tool Table

Standard contacts

Contact size	Part number	Head*	Handles*	Extraction tools
#16 Ø1.6 mm	RM/RC 28M1*	S16RCM20	SHANDLES	RX2025GE1
	RM/RC 24M9*			
	RM/RC 20M13*			
	RM/RC 20M12*			
	RM/RC 16M23*	S16RCM16		
	RM/RC 14M30*	S16RCM14		
	SM/SC 24ML1* ⁽¹⁾	S16SCM20		
	SM/SC 20ML1* ⁽¹⁾			
	SM/SC 16ML1* ⁽¹⁾	S16SCML1		
	SM/SC 14ML1* ⁽¹⁾	S16SCML11		
SM/SC 16ML11* ⁽¹⁾				

(1) loose contact * endurance of SHANDLES & Head tools = 50,000 cycles

Quick Mating PC board mount connectors

Description

These PC board mount connectors enable Quick Mating and preassembled TRIM TRIO contacts to be PC board mounted, using conventional solder production techniques.

They will then mate and latch with the standard Quick Mating plugs.

Straight board mount connectors is available in 10 insert arrangements from 2 to 36 positions. Right angled board mount Quick Mating is available in 3, 6, 12 and 18 positions.

All board mount connectors are supplied fully loaded with pin or socket contacts, either in solid machined or stamped and formed contacts.

Stamped and formed contact have selective tin plating on the solder tails, thus eliminating flux operations.

Features and benefits

- Straight versions available in 10 contact arrangements from 2 to 36 positions
- Right angled versions available in 3, 6, 12 and 18 positions.
- All versions are available with:
 - Pin or socket contacts
 - Stamped and formed or solid machined contacts.
- Board mount connectors have discrimination cavities in between contact cavities, unless other wise noted. See instruction page 21.
- UL recognized File Nr.: E238675
- CSA certified File Nr.: LR44961-21

Environmental

- Operating temperature: -55°C to +105°C
- Insulation resistance: 5000 MΩ min.



- Test potential: 2000 VAC
- Current rating for SMS PCB version:
 - 5 Amp for stamped and formed contacts
 - 7.5 Amp for machined contacts
- Electrical performances for crimped versions:
 - UL: 250V - 15A
 - CSA: 250V - 15A
- Durability: 500 matings and unmatings
- Sealing performances: IP40

Material

- Connector body:
 - Glass filled thermoplast UL94 V0
- Railway version :
 - I2 F3 according to NF F 16-101
 - HL2/R23 according to EN 45 545
- Contacts:
 - High conductive copper alloy
- Soldering information:
 - compatible with wave soldering up to 245°C.
 - Not compatible with reflow soldering.

Plating table

- **Plating for solid machined contacts:**
 - Made for 2.4mm or 3.2mm PCB thickness (straight contacts) and for 3.2mm PCB

thickness (right contacts)

K9 (std) = Min. 0.4µ Gold in contact area,
Tin on solder tail, over Nickel

J9 = Gold flash in contact area,
Tin on solder tail, over Nickel

T = 3 - 5µ Tin all over

- **Plating for Stamped and formed contacts:**

- Made for 2.4mm PCB thickness (straight contacts) and for 3.2mm PCB thickness (right contacts)

K9 = Min. 0.4µ Gold in contact area,
3- 5µ Tin on solder tail, over Nickel

T = 3 - 5µ Tin all over

- Made for 3.2mm PCB thickness (straight contacts)

S6 = Min. 0.75µ Gold in contact area
Gold flash on solder tail, over Nickel

D70 = Gold flash all over
TR29 = 3 - 5µ Tin all over

Intermateability

- "SMS" Quick Mating board mount connectors with preassembled TRIM TRIO size 16 board mount contacts are intermateable only with the "SMS" Quick Mating cable plug connectors equipped with TRIM TRIO crimp type removable snap-lock contacts (see contact section).

Ordering information

Connector family	SMS	12	GE	3	0	K9
Layout: see page 14						
Body variation:						
GE: Solid machined contacts (2.4mm or 3.2mm, see option below)						
SE: Stamped and formed contacts for 2.4mm PCB						
RE: Stamped and formed contacts for 3.2mm PCB						
Design variation:						
3: Straight board mount with female contact						
4: Straight board mount with male contacts						
5: Right angle board mount with female contacts						
6: Right angle board mount with male contacts						
Option:						
-: 2.4mm for GE3, GE4 and SE variation						
0: 3.2mm for GE variation						
3: Railway version: I2 F3 according to NF F 16-101 and HL2/R23 according to EN 45 545						
Plating indication						

Connectors

Straight board mount with female contacts

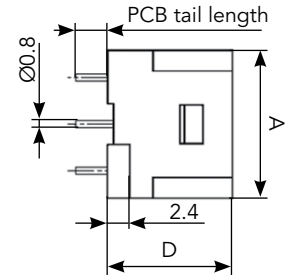
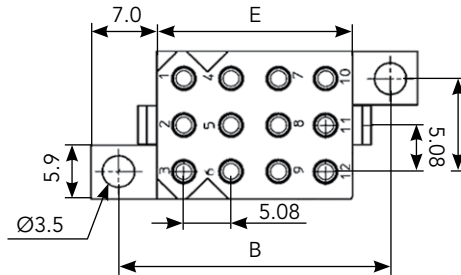
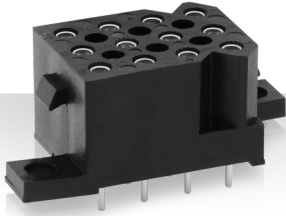

Dimensions

Nbr. of contact	Nbr. of discrimination cavities	A	B	C	D	E
2	0	11.0	-	19.1	13.4	5.9
3	0	16.2	14.0	10.2		
4	0	21.3		15.2		
6	0	16.2	19.2	10.2		10.9
9	4		24.2			16.0
12	0		29.2			21.1
15	8		34.3			26.1
18	10	21.2	39.4	15.2		31.2
24	0			15.2		20.9
36	0	46.5	15.2	54.6		

Contacts type

Part number				
Standard version				NFF certified version
Solid machined contacts		Stamped & formed contacts		Solid machined contacts
PCB thickness 2.4mm PCB tail length 3.4mm	PCB thickness 3.2mm PCB tail length 4.2mm	PCB thickness 2.4mm PCB tail length 3.4mm	PCB thickness 3.2mm PCB tail length 4.4mm	PCB thickness 2.4mm PCB tail length 3.4mm
SMS2GE3*	SMS2GE30*	SMS2SE3*	SMS2RE3*	-
SMS3GE3*	SMS3GE30*	SMS3SE3*	SMS3RE3*	SMS3GE33*
SMS4GE3*	SMS4GE30*	SMS4SE3*	SMS4RE3*	-
SMS6GE3*	SMS6GE30*	SMS6SE3*	SMS6RE3*	SMS6GE33*
SMS9GE3*	SMS9GE30*	SMS9SE3*	SMS9RE3*	SMS9GE33*
SMS12GE3*	SMS12GE30*	SMS12SE3*	SMS12RE3*	SMS12GE33*
SMS15GE3*	SMS15GE30*	SMS15SE3*	SMS15RE3*	SMS15GE33*
SMS18GE3*	SMS18GE30*	SMS18SE3*	SMS18RE3*	SMS18GE33*
SMS24GE3*	SMS24GE30*	SMS24SE3*	SMS24RE3*	SMS24GE33*
SMS36GE3*	SMS36GE30*	SMS36SE3*	SMS36RE3*	SMS36GE33*

* for coding see page 11
 Example: SMS12GE3J9 - SMS with 12 solid machined contacts, plating J9

Straight board mount with male contacts

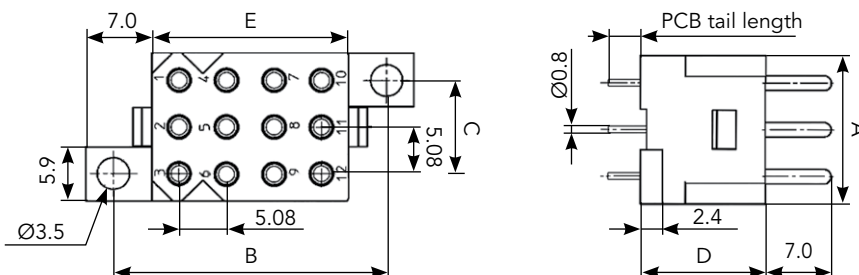

Dimensions

Nbr. of contact	Nbr. of discrimination cavities	A	B	C	D	E
2	0	11.1	-	19.1	13.4	5.9
3	0	16.2	14.0	10.2		
4	0	21.3		15.2		
6	0	16.2	19.2	10.2		10.9
9	4		24.2			16.0
12	0		29.2			21.1
15	8		34.3			26.1
18	10	21.2	39.4	15.2		31.2
24	0					46.5
36	0					

Contacts type

Part number				
Standard version				NFF certified version
Solid machined contacts		Stamped & formed contacts		Solid machined contacts
PCB thickness 2.4mm PCB tail length 3.4mm	PCB thickness 3.2mm PCB tail length 4.2mm	PCB thickness 2.4mm PCB tail length 3.4mm	PCB thickness 3.2mm PCB tail length 4.4mm	PCB thickness 2.4mm PCB tail length 3.4mm
SMS2GE4*	SMS2GE40*	SMS2SE4*	SMS2RE4*	-
SMS3GE4*	SMS3GE40*	SMS3SE4*	SMS3RE4*	SMS3GE43*
SMS4GE4*	SMS4GE40*	SMS4SE4*	SMS4RE4*	-
SMS6GE4*	SMS6GE40*	SMS6SE4*	SMS6RE4*	SMS6GE43*
SMS9GE4*	SMS9GE40*	SMS9SE4*	SMS9RE4*	SMS9GE43*
SMS12GE4*	SMS12GE40*	SMS12SE4*	SMS12RE4*	SMS12GE43*
SMS15GE4*	SMS15GE40*	SMS15SE4*	SMS15RE4*	SMS15GE43*
SMS18GE4*	SMS18GE40*	SMS18SE4*	SMS18RE4*	SMS18GE43*
SMS24GE4*	SMS24GE40*	SMS24SE4*	SMS24RE4*	SMS24GE43*
SMS36GE4*	SMS36GE40*	SMS36SE4*	SMS36RE4*	SMS36GE43*

* for coding see page 11
 Example: SMS12GE4J9 - SMS with 12 solid machined contacts, plating J9

Connectors (Continued)

Right angle board mount with female contacts



Dimensions

Nbr. of contact	Nbr. of discrimination cavities	A	B	C	D	E	F	G
3	0	16.5	14.4	20.5	30.2	24.2	16.2	6.8
6	0	19.0		24.5				11.9
12	6	21.6		29.5	35.2	29.2	21.2	17.2
18	10		45.4	39.4	31.2			

Contacts type

Part number		
Standard version		NFF certified version
Solid machined contacts	Stamped & formed contacts	Solid machined contacts
PCB thickness 3.2mm PCB tail length 4.5mm	PCB thickness 3.2mm PCB tail length 4.5mm	PCB thickness 3.2mm PCB tail length 4.5mm
SMS3GE5*	SMS3SE5*	SMS3GE53*
SMS6GE5*	SMS6SE5*	SMS6GE53*
SMS12GE5*	SMS12SE5*	SMS12GE53*
SMS18GE5*	SMS18SE5*	SMS18GE53*

* for coding see page 11
Example: SMS12GE5J9 - SMS with 12 solid machined contacts, plating J9

Right angle board mount with male contacts

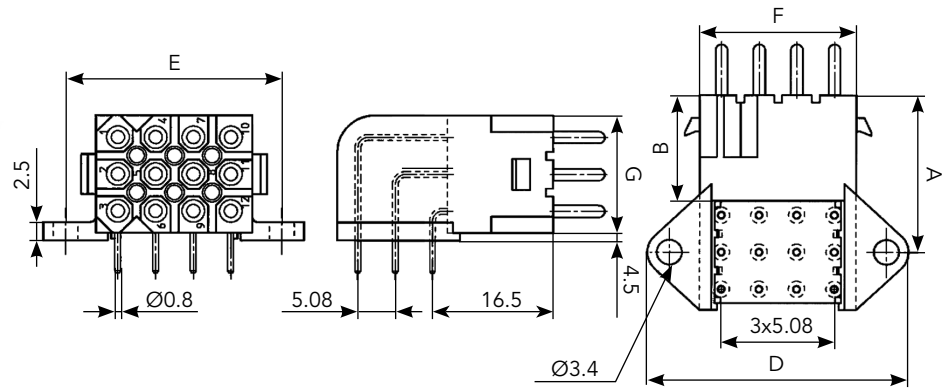
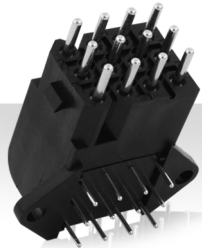

Dimensions

Nbr. of contact	Nbr. of discrimination cavities	A	B	C	D	E	F	G
3	0	16.5	14.4	20.5	30.2	24.2	16.2	6.8
6	0	19.0		24.5				11.9
12	6	21.6		29.5				35.2
18	10		45.4	39.4	31.2			

Contacts type

Part number		
Standard version		NFF certified version
Solid machined contacts	Stamped & formed contacts	Solid machined contacts
PCB thickness 3.2mm PCB tail length 4.5mm	PCB thickness 3.2mm PCB tail length 4.5mm	PCB thickness 3.2mm PCB tail length 4.5mm
SMS3GE6*	SMS3SE6*	SMS3GE63*
SMS6GE6*	SMS6SE6*	SMS6GE63*
SMS12GE6*	SMS12SE6*	SMS12GE63*
SMS18GE6*	SMS18SE6*	SMS18GE63*

* for coding see page 11
Example: SMS12GE6J9 - SMS with 12 solid machined contacts, plating J9

Drilling Pattern

Dimensions

Straight angle board mount

2 contacts

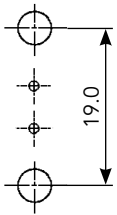

3 contacts

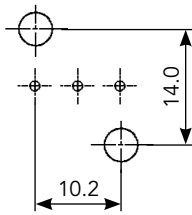

4 contacts

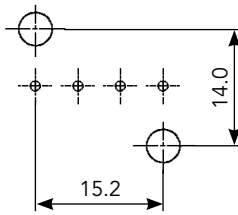

6 contacts

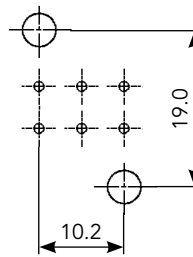

9 contacts

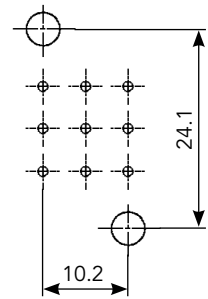

12 contacts

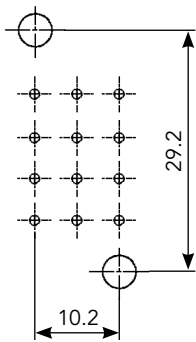

15 contacts

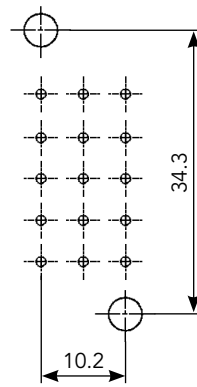

18 contacts

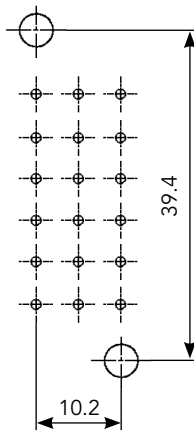

24 contacts

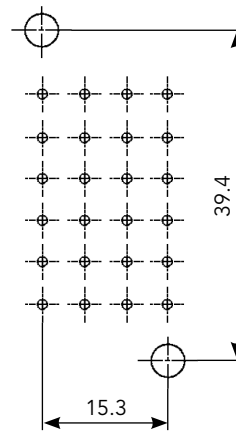

36 contacts

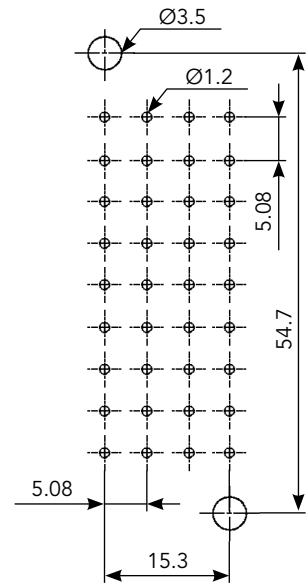

Right angle board mount

3 contacts

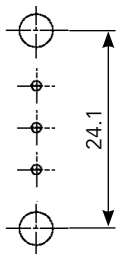

6 contacts

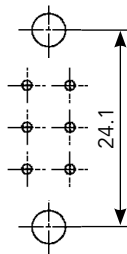

12 contacts

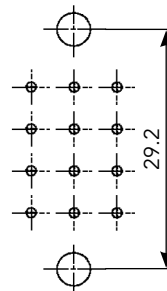

18 contacts

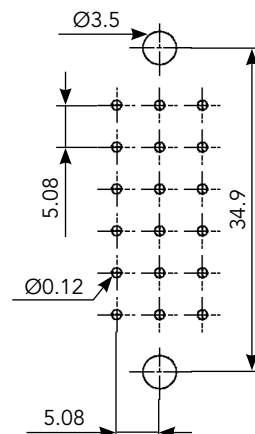

Note: all dimensions are in mm

Secure connector with screws (not supplied), recommended torque 0.3 N.m

Quick Mating PC board mount Pin Headers and plugs

Description

Quick Mating Pin Header, available in 3, 4, 6, 9 and 10 positions, provides the additional versatility of straight and right angle board mounting.

Offered as an alternative to stacked connectors, the in-line contact design of the pin header provides the user with significant PC board space savings.

The board mount receptacle features positive polarization and a moulded on pin protection skirt and is supplied preassembled with straight or right angled:

- Solid machined or stamped and formed PC board pin contacts.
- Coax PC board pin contacts.

The socket cable plug features positive quick connect / disconnect latches and is designed to accept N° 16 TRIM TRIO 1.6mm diameter socket contacts for maximum contact protection.

Features and benefits

- Available in 3, 4, 6, 9 and 10 positions.
- In-line contact design, offering significant PC board space savings.
- Board mount connectors available in straight and right angled version preassembled with:
 - Solid machined or stamped and formed pin contacts.
 - Coax pin contacts.
- UL recognized File Nr.: E238675
- CSA metter certified File Nr.: LR44961-21

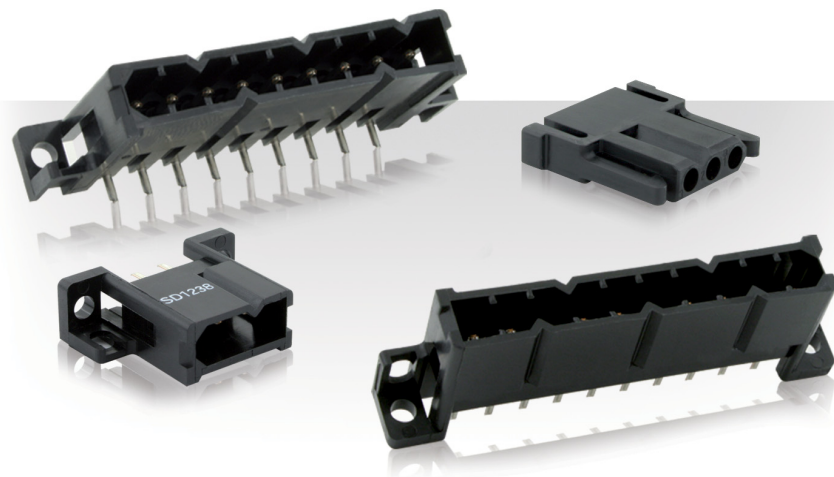

Environmental

- Operating temperature: -55°C to +125°C
- Insulation resistance: 5000 MΩ min.
- Test potential: 2000 VAC
- Current rating:
 - 5 Amp for stamped and formed contacts
 - 7.5 Amps for machined contacts
- Durability: 500 matings and unmatings.

Material

- Connector body:
 - Glass filled thermoplast UL94 V0
 - Color: Black
- Contacts: High conductive copper alloy

Plating table

- **Plating for solid machined contacts:**
 - No digit (std) = Min. 0.4μ Gold all over, over Nickel.

- J = Gold flash over 2μ Ni
- T = 3 - 5μ Tin all over
- **Plating for Stamped and formed contacts:**
 - D28 = Min. 0.75μ Au over nickel.
 - D70 = Active part: Gold flash over Ni
Crimp area: Ni
 - TR29 = 3 - 5μ Tin all over
- **Plating for coax contacts:**
 - Z17 = Min. 0.75μ Au in contact area,
Flash on solder tail (inner)
Min 0.75μ Au in contact area,
Tin on solder tail (outer)

Intermateability

- "SMS" Socket plugs accept TRIM TRIO size 16 removable snap-lock contacts (see contact section)
- Contacts to be ordered separately.

Ordering information

Connector family	SMS	12	PH	3	0	TR29
Layout: see page 14						
Body variation:						
PH: Pin header board mount						
CH: Coax header board mount						
P3: Socket cable plug for pin and coax header board mount						
Design variation:						
2: Straight coax header board mount with male contacts						
3: Right angle pin header board mount with stamped male contacts						
4: Straight pin header board mount with stamped male contacts						
GE6: Right angle pin header board mount with machined male contacts						
GE4: Straight pin header board mount with machined male contacts						
Plating indication						

Connectors (Continued)

Right angle pin header board mount with male contacts

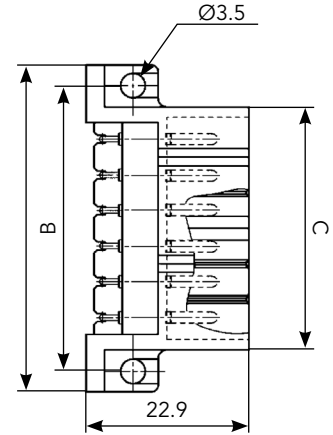
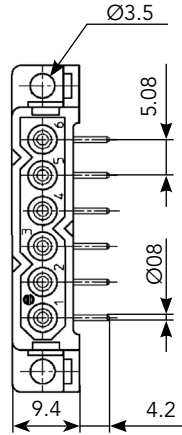
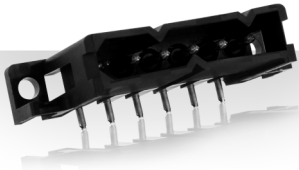

Part number		Nbr. of contact	A	B	C
Solid machined contacts	Stamped & formed contacts				
SMS3PH3*	SMS3PHGE6	3	31.2	25.4	19.3
SMS4PH3*	SMS4PHGE6	4	36.3	30.4	24.4
SMS6PH3*	SMS6PHGE6	6	46.5	40.6	34.5
SMS9PH3*	SMS9PHGE6	9	61.7	55.9	49.8
SMS10PH3*	SMS10PHGE6	10	66.8	61.0	54.9

* for coding see page 17
 Example: SMS9PH3J9 - SMS with 9 solid machined contacts, plating J9

Straight pin header board mount with male contacts

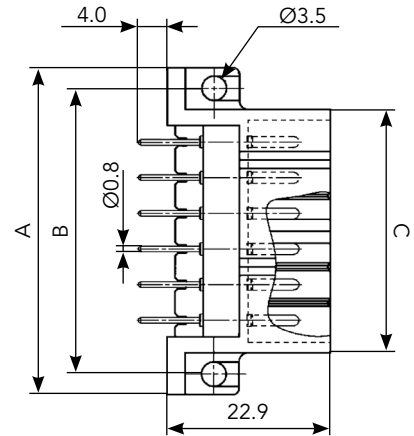
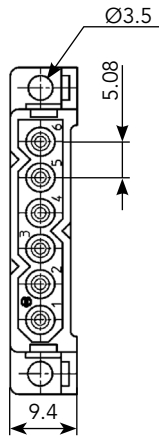
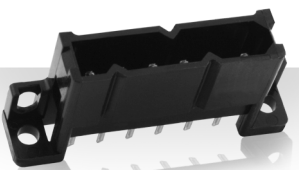

Part number		Nbr. of contact	A	B	C
Solid machined contacts	Stamped & formed contacts				
SMS3PH4*	SMS3PHGE4	3	31.2	25.4	19.3
SMS4PH4*	SMS4PHGE4	4	36.3	30.4	24.4
SMS6PH4*	SMS6PHGE4	6	46.5	40.6	34.5
SMS9PH4*	SMS9PHGE4	9	61.7	55.9	49.8
SMS10PH4*	SMS10PHGE4	10	66.8	61.0	54.9

* for coding see page 17
 Example: SMS9PH4J9 - SMS with 9 solid machined contacts, plating J9

Note: all dimensions are in mm

Straight coax header board mount with male contacts

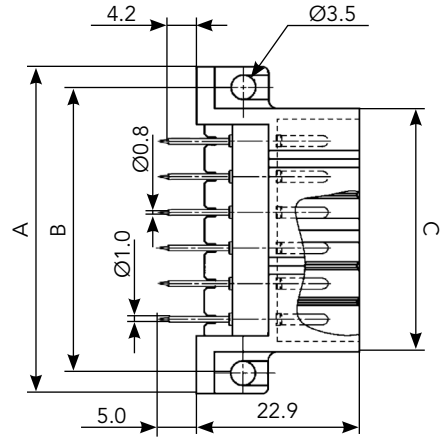
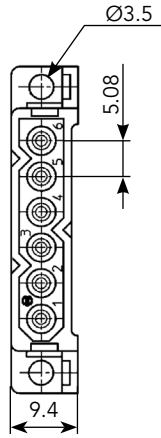
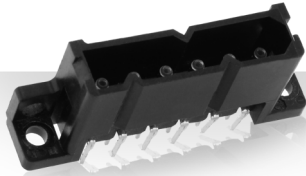

Part number	Nbr. of contact	A	B	C
SMS3CH2Z17	3	31.2	25.4	19.3
SMS4CH2Z17	4	36.3	30.4	24.4
SMS6CH2Z17	6	46.5	40.6	34.5
SMS9CH2Z17	9	61.7	55.9	49.8
SMS10CH2Z17	10	66.8	61.0	54.9

* for coding see page 17

Socket cable plug for pin and coax board mount header

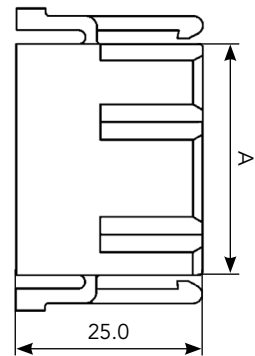
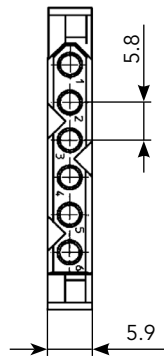

Part number	Number of contact*	A
SMS3P3	3	16.0
SMS4P3	4	21.1
SMS6P3	6	31.2
SMS9P3	9	46.5
SMS10P3	10	51.6

*Contacts supplied separately

Note: all dimensions are in mm

Drilling Pattern

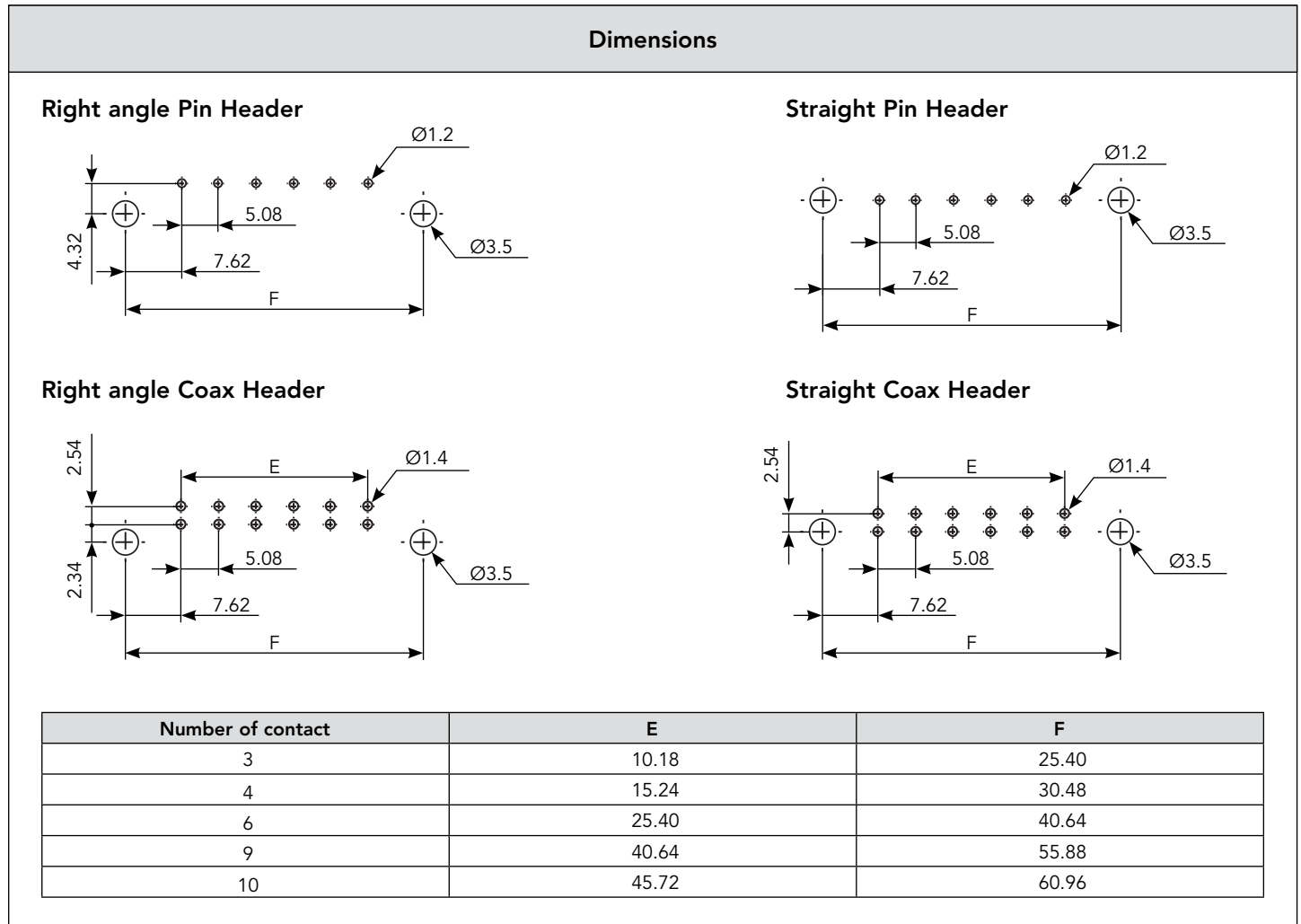

Discrimination keys for SMS connectors

In applications where similar connectors are used next to each other, mismatching can be a reason for disturbances, system failure or even danger to operator.

To eliminate mismatching, all SMS can be equipped with discrimination solutions, which offer unlimited possibilities for a "fool-proof" interconnection system.

When one of these discrimination keys is used, the SMS will only mate with a connector which has a vacant contact or discrimination cavity at the corresponding position.

This system offers boundless opportunities for all applications.

The material used is polyamide 6.6.

Both connectors have removable contacts: SMSPE0

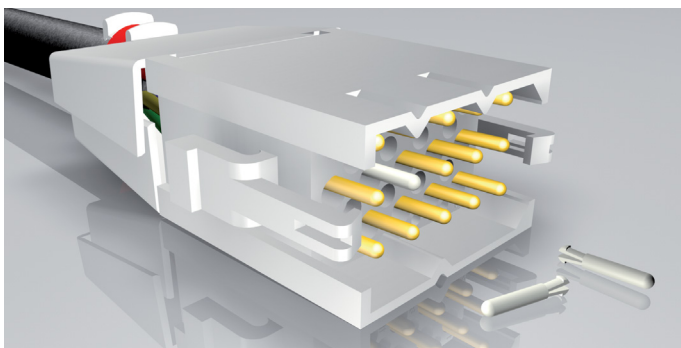

A dummy contact, which can be inserted into an empty contact cavity in any of SMS connectors.

Specially for connectors without discrimination cavities and without removable pin contact: SMSPEB2

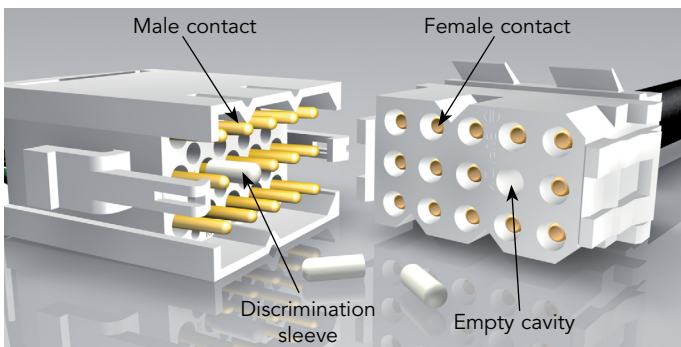

A tube, which can be fitted over a preassembled male contact in all industrial male boardmount connectors SMS.

For fixe female contacts and without discrimination cavities: SMSPE2V1

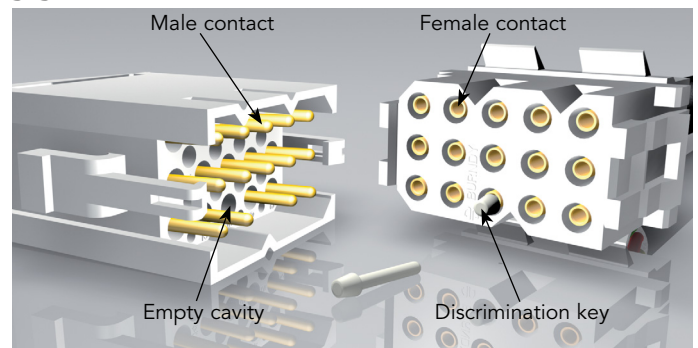

A pin, which can be inserted into a preassembled female contact in all female boardmount connectors SMS.

Both connectors have discrimination cavities: SMSPE3

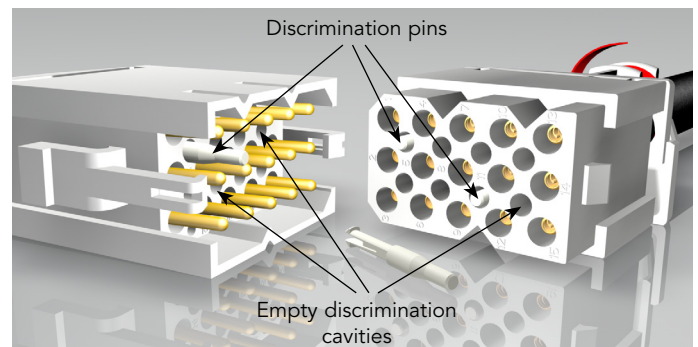

A pin, which can be inserted in the discrimination cavities of the SMS Quick mating cable and boardmount connectors. The discrimination cavities are in between of the contact cavities and offer the advantage that no contact cavities are lost due to discrimination.

As extraction tool, the RX2025GE1 without the "extraction tool tip" can be used.



RX2025GE1

Reliable People, Reliable Solutions



Your local contact



Our contribution to environmental protection:
This catalog is printed on PEFC certified paper
Advancement of sustainable wood cultivation. www.pefc.org

www.souriau-industrial.com
contactindustry@souriau.com



SOURIAU