

REAL TIME CLOCK MODULE

AB-RTCMK-32.768kHz

Moisture Sensitivity Level (MSL)



RoHS
Compliant

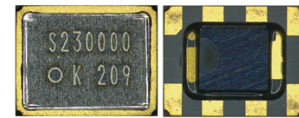

3.2 x 2.5 x 1.0 mm

FEATURES:

- Exceptional Frequency Stability over temperature; ± 5.0 ppm max. over -40°C to $+85^{\circ}\text{C}$
- Operating Voltage; $+1.30\text{V}$ to $+5.50\text{V}$
- $4.0\mu\text{A}$ max. current at no load
- I2C Communication
- Clock function : Hour/ Min / Sec
- Leap year automatic distinction calendar function till 2099
- Alarm interruption function for day, date, hour and minute settings
- A constant cycle timer interruption function : 244.14us to 255 min
- Time update interruption function : Min / Sec
- Clock output function : 32.768kHz / 1024Hz / 32Hz / 1Hz

APPLICATIONS:

- Smart cards
- Wireless sensors and tags
- Medical electronics
- Utility meters
- Data loggers
- Appliances
- Handsets
- Consumer electronics

STANDARD SPECIFICATIONS:

Parameters	Minimum	Typical	Maximum	Units	Notes
Nominal Frequency (f0)		32.768		kHz	
Frequency Tolerance (df/f0)	-3.0		+3.0	ppm	Initial + 2 times reflow Ta= $\pm 25 \pm 2^{\circ}\text{C}$
Frequency Stability vs Temp. (df/f0)	-5.0		+5.0	ppm	Ta= -40 to $+85^{\circ}\text{C}$
Frequency Stability vs Voltage (df/dV)	-1.0		+1.0	ppm/V	Ta= $+25^{\circ}\text{C}$ V _{DD} =2.0 to 5.5V
Frequency Aging Rate (dfag)	-3.0		+3.0	ppm	Ta= $+25^{\circ}\text{C}$, first year
Start Up Time (Tst)			1.0	sec	Ta= $+25^{\circ}\text{C}$ V _{DD} =1.3V
			3.0	sec	Ta= -40 to $+85^{\circ}\text{C}$ V _{DD} =1.3 to 5.5V
Power Supply Current 1 (I _{DD1})		0.6	2.0	uA	SCL=SDA=/INT=V _{DD} CLKOUT=V _{SS} , V _{DD} =3V
Power Supply Current 2 (I _{DD2})		1.5	4.0	uA	SCL=SDA=/INT=V _{DD} CLKOUT=V _{DD} , V _{DD} =3V, CL _{OUT} =0pF
Input Leak Current (I _{LK})	-0.5		+0.5	uA	CLKOE,SCL,SDA V _{IN} =V _{DD} or V _{SS}
Output Leak Current (I _{OZ})	-0.5		+0.5	uA	CLKOUT,/INT,SDA V _{OUT} =V _{DD} or V _{SS}
“H” Input Voltage (V _{IH})	0.8 x V _{DD}		5.5	V	CLKOE,SCL,SDA
“L” Input Voltage (V _{IL})	0.0		0.2 x V _{DD}	V	CLKOE,SCL,SDA
“H” Output Voltage (V _{OH})	2.2		3.0	V	CLKOUT, V _{DD} =3.0V, I _{OH} =-1mA
“L” Output Voltage	V _{OL1}	0.0	0.8	V	CLKOUT, V _{DD} =3.0V, I _{OL} =1mA
	V _{OL2}	0.0	0.4	V	/INT, V _{DD} =3.0V, I _{OL} =1mA
	V _{OL3}	0.0	0.4	V	SDA, V _{DD} $\geq 2.0\text{V}$, I _{OL} =3mA
Low Voltage Detection Voltage (V _{DET})	1.3	1.4	1.5	V	

For detail data sheet, please contact tech-support@abracon.com

ABRACON IS
ISO 9001 : 2008
CERTIFIED



Visit www.abracon.com for Terms & Conditions of Sale **Revised: 08.15.12**
30332 Esperanza, Rancho Santa Margarita, California 92688
tel 949-546-8000 | fax 949-546-8001 | www.abracon.com

REAL TIME CLOCK MODULE

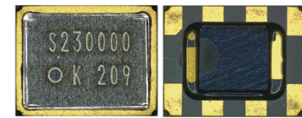

3.2 x 2.5 x 1.0 mm

AB-RTCMK-32.768kHz



RoHS
Compliant

AC ELECTRICAL CHARACTERISTICS

Parameters	Minimum	Typical	Maximum	Units	Notes
SCL Clock Frequency (f_{SCL})			400	kHz	
START Condition Setup Time ($t_{SU,STA}$)	0.6			sec	
START Condition Hold Time ($t_{HD,STA}$)	0.6			sec	
Data Input Setup Time ($t_{SU,DAT}$)	100			nsec	
Data Input Hold Time ($t_{HD,DAT}$)	0		900	nsec	
STOP Condition Setup Time ($t_{SU,STO}$)	0.6			sec	
Bus Idle Time Between START and STOP Condition (t_{BUF})	1.3			sec	
SCL Low Time (t_{LOW})	1.3			sec	
SCL High Time (t_{HIGH})	0.6			sec	
SCL, SDA Rise Time (t_r)			0.3	sec	20% to 80%
SCL, SDA Fall Time (t_f)			0.3	sec	80% to 20%
Allowable Spike Time on Bus (t_{SP})			50	nsec	

TIMING CHART

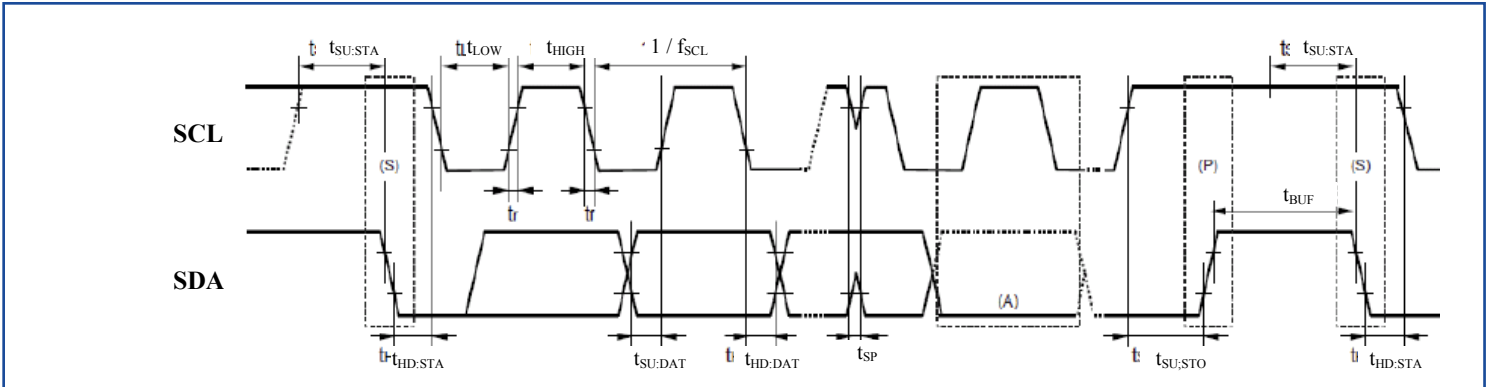

PART IDENTIFICATION:

AB - RTCMK - 32.768 kHz -

Packaging
Blank: Bulk
T: 1000pcs/reel
T3: 3000pcs/reel

ABRACON IS
ISO 9001 : 2008
CERTIFIED



ABRACON
CORPORATION

Visit www.abracon.com for Terms & Conditions of Sale

Revised: 08.15.12

30332 Esperanza, Rancho Santa Margarita, California 92688

tel 949-546-8000 | fax 949-546-8001 | www.abracon.com

REAL TIME CLOCK MODULE

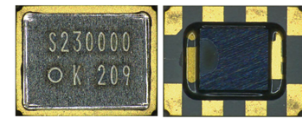

3.2 x 2.5 x 1.0 mm

AB-RTCMK-32.768kHz



FUNCTION:

Pin No.	Pin Name	I/O	Function
1	CLKOE	Input	This is an input pin used to control the output mode of the CLKOUT pin. When this pin's level is high, the CLKOUT pin is in output mode. When it is low, the CLKOUT pin is "Hi-Z" (High Impedance).
2	/INT	Output	This pin is used to output alarm signals, timer signals, timer update signals, and other signals. This pin is an open drain pin.
3	N.C.		This pin is open.
4	VSS		This pin is connected to ground.
5	CLKOUT	Output	This pin outputs a 32.768kHz signal. This is the C-MOS output pin with output control provided via the CLKOE pin.
6	SCL	Input	This is the serial clock input for I ² C BUS communications.
7	SDA	I/O	This is the serial data input/output for I ² C BUS communications. This pin's signal is used for input and output of address, data, and ACK bits, synchronized with the serial clock used for I ² C communication. This pin is an N-ch open drain pin during output.
8	VDD		This pin is connected to a positive power supply.

BLOCK DIAGRAM:

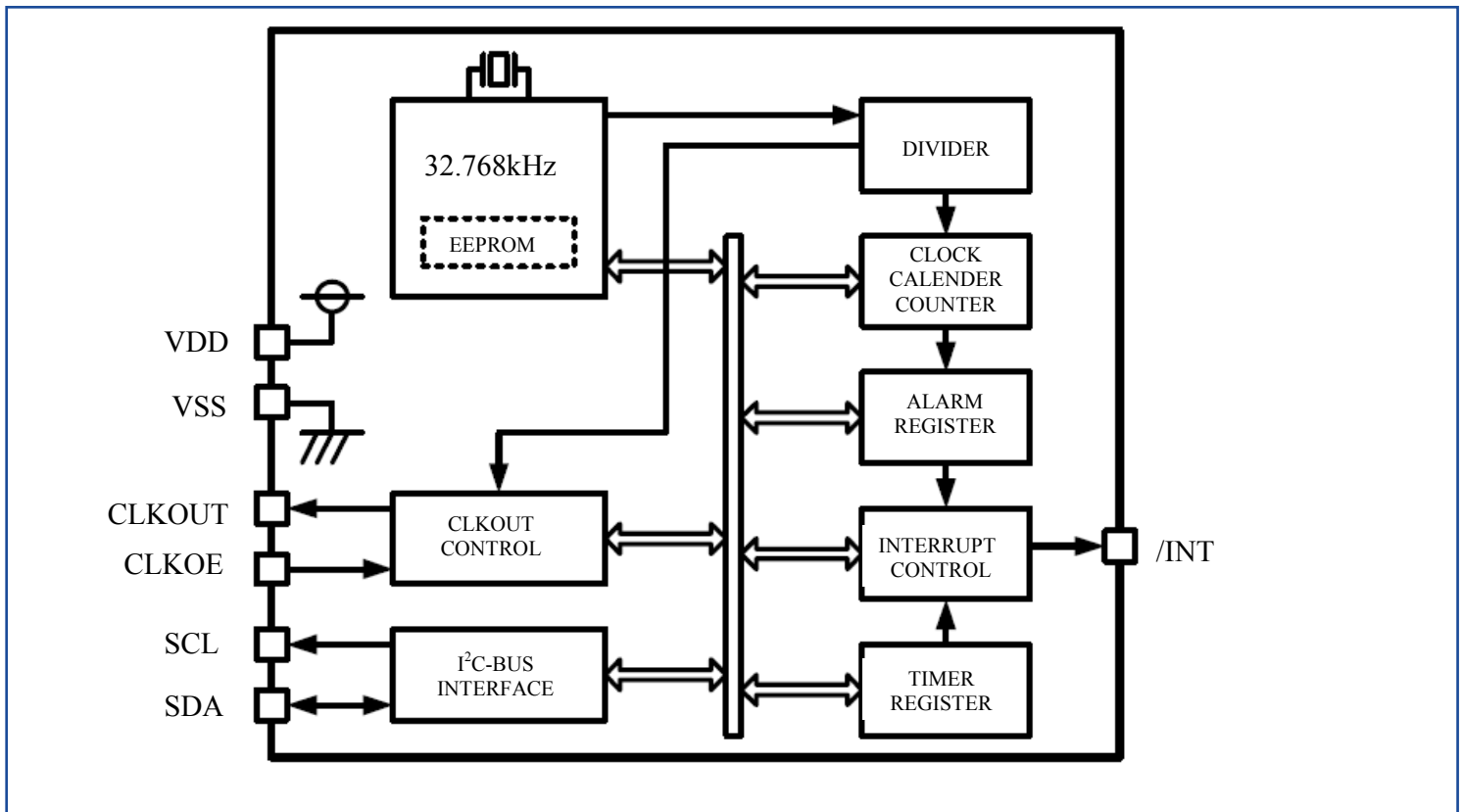

REAL TIME CLOCK MODULE

AB-RTCMK-32.768kHz



RoHS
Compliant

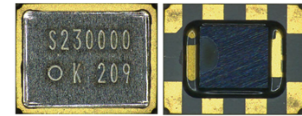

3.2 x 2.5 x 1.0 mm

MARKING:

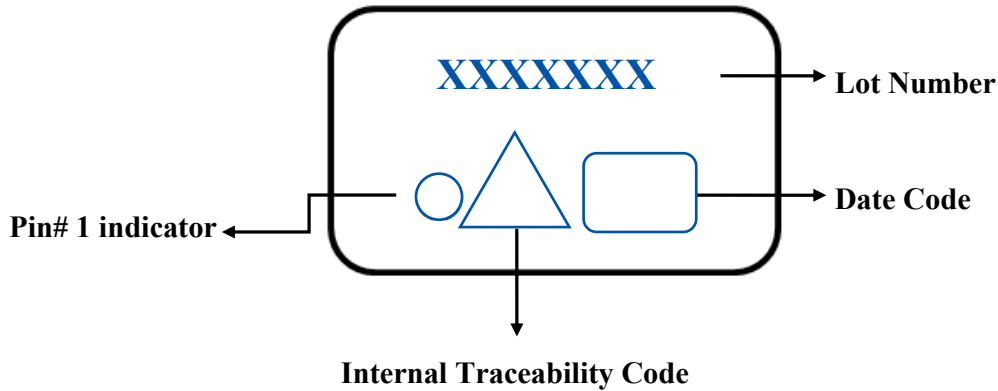

OUTLINE DRAWING:

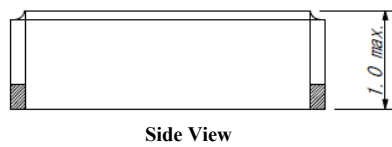
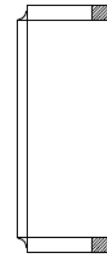
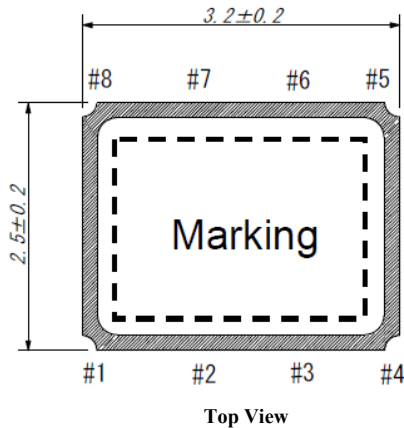

PIN / Function

#1 : CLKOE	#5 : CLKOUT
#2 : /INT	#6 : SCL
#3 : N.C.	#7 : SDA
#4 : VSS	#8 : VDD

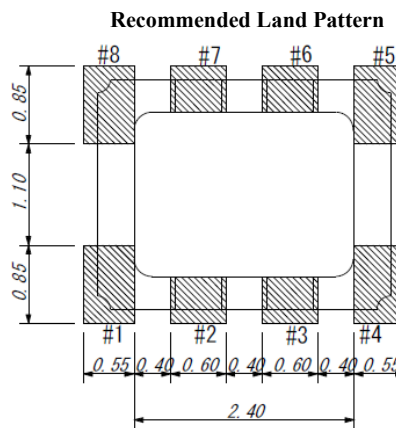
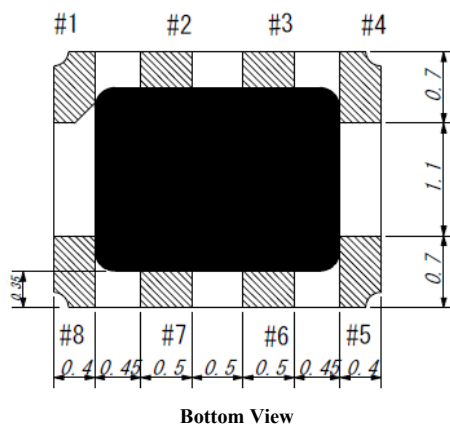

Dimension : mm



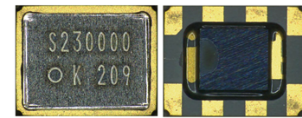

3.2 x 2.5 x 1.0 mm

AB-RTCMK-32.768kHz



RoHS
Compliant

TAPE & REEL:

T: 1000pcs/reel
T3: 3000pcs/reel

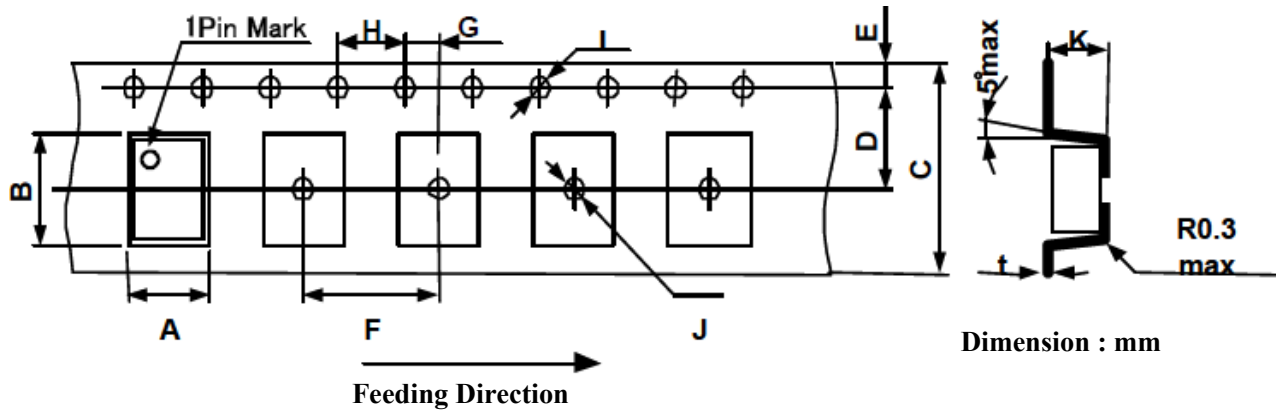

A	B	C	D	E	F
2.80 ± 0.1	3.50 ± 0.1	8.00 ± 0.3	3.50 ± 0.05	1.75 ± 0.1	4.00 ± 0.1
G	H	I	J	K	T
2.00 ± 0.05	4.00 ± 0.1	ø1.5 +1.0/-0	ø 1.5 +1.0/-0	1.10 ± 0.1	0.25 ± 0.05

Reel Dimensions

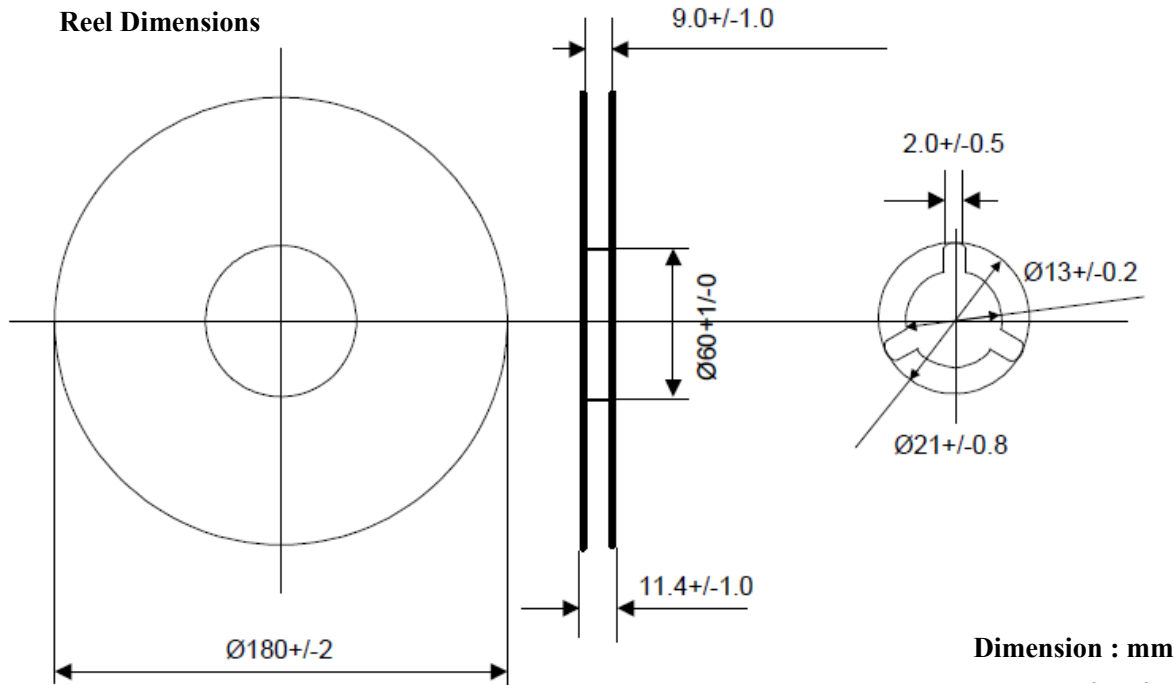

For detail data sheet, please contact tech-support@abracon.com

ATTENTION: Abracon Corporation's products are COTS – Commercial-Off-The-Shelf products; suitable for Commercial, Industrial and, where designated, Automotive Applications. Abracon's products are not specifically designed for Military, Aviation, Aerospace, Life-dependant Medical applications or any application requiring high reliability where component failure could result in loss of life and/or property. For applications requiring high reliability and/or presenting an extreme operating environment, written consent and authorization from Abracon Corporation is required. Please contact Abracon Corporation for more information.

ABRACON IS
ISO 9001 : 2008
CERTIFIED



Visit www.abracon.com for Terms & Conditions of Sale

Revised: 08.15.12

30332 Esperanza, Rancho Santa Margarita, California 92688

tel 949-546-8000 | fax 949-546-8001 | www.abracon.com

X-ON Electronics

Largest Supplier of Electrical and Electronic Components

Click to view similar products for [abracon](#) manufacturer:

Other Similar products are found below :

[ACO-1.000MHZ](#) [ABLS-12.000MHZ-B2Y-T](#) [ASGTX-BLANK](#) [ABLNO-122.880MHz](#) [ABLNO-V-96.000MHZ](#) [ABLS-10.240MHZ-B4-T](#)
[ABLS2-3.6864MHZ-D4Y-T](#) [ABLS-30.000MHZ-L4QF-T](#) [ACHL-18.432MHZ-EK](#) [AOCJY2-100.000MHz-F](#) [ARRSN5-868.000MHz](#)
[ASEMPLP- ADAPTER-KIT](#) [ASFLMPLV- ADAPTER-KIT](#) [ASGTX-P-1.000GHz-1](#) [AST3TQ-T-24.576MHz-50-C](#) [ASTMLPD-24.000MHz-](#)
[LJ-E-T](#) [ABLJO-V-150.000MHz](#) [ABM2-16.000MHZ-D4Y-T](#) [ABM8G-12.000MHZ-B4Y-T3](#) [AIRD-06-101K](#) [AOCJY3-40.000MHZ](#)
[AOCJY6-10.000MHz-1](#) [ASG-C-V-A-50.000MHz](#) [ASG-D-V-A-500.000MHz](#) [ASHEK2-32.768KHZ-LT](#) [AXS-5032-04-12](#) [AIML-0805-470K-](#)
[T](#) [ARJ-150A](#) [AOCJY3A-10.000MHZ-E](#) [ASFL1-50.000MHZ-EK-T](#) [ASVTX-09-16.000MHZ-T](#) [AOCTQ5-X-10.000MHz-M10-SW](#)
[AMPMAFB-19.2000T](#) [ABL-10.000MHZ-D-T](#) [ABM3B-27.120MHZ-10-D2H-T](#) [EP1400SJETTSC-11.0592M](#) [EP1400SJETTSC-2.000M](#)
[EHH1100TS-13.560M](#) [ABL-16.384MHZ-B2](#) [ABLJO-V-155.520MHZ](#) [ABM3B-26.000MHZ-10-D-1-G-T](#) [AIRD-01-680K](#) [AOCJY-](#)
[100.000MHZ](#) [AOCJY-10.000MHz](#) [AOCJY2-10.000MHz](#) [AOCJY3-40.000MHZ-E](#) [AOCJY-38.880MHZ-F](#) [AOCJY3A-100.000MHz-E](#)
[APAMS-119](#) [ASG2-D-X-A-1000.000MHz](#)