

DATE OF ISSUE : 09/05/2011

SPECIFICATION

MODEL : SPHWHTHAD605S0U0VZ

HV-AC HIGH POWER LED

**CUSTOMER :**

DRAWN	CHECKED	APPROVED

SAMSUNG LED

DRAWN	CHECKED	APPROVED

SAMSUNG LED CO.,LTD.**314. MAETAN3-DONG, YEONGTONG-KU,
SUWON-SI, GYUNGKI-DO, KOREA, 442-743**

Contents

1.	Product Outline	-----	3
2.	Absolute Maximum Rating	-----	3
3.	Characteristics	-----	3
4.	Typical Characteristic Graphs	-----	8
5.	Outline Drawing & Dimension	-----	11
6.	Solder Conditions	-----	12
7.	Reliability Test Items & Conditions	-----	13
8.	Circuit Design - Package and PCB	-----	14
9.	Taping Dimension	-----	15
10.	Label Structure	-----	16
11.	Lot Number	-----	16
12.	Reel Packing Structure	-----	17
13.	Aluminum Packing Bag	-----	19
14.	Precaution For Use	-----	20
15.	Hazard Substance Analysis	-----	22
16.	Revision History	-----	25

1. Product Outline

1) Features

- Plastic Molded Lead Frame Type : 12.4mm(L), 11.4mm(W), 4.38mm(T)
- SMD Type : 1 Heat Pad and 4 Electrical Pad
- Beam View Angle($\Delta\theta$) * :136°
- High Power / Brightness Chip & Long Time Reliability

2) Applications

- Indoor & Outdoor lighting
- Direct AC power source plug-in (100~120Vac, 220~240Vac)

※ View Angle describes the spatial intensity distribution and is the difference between the angles corresponding to 50% of the maximum intensity. (Full Width Half Maximum)

2. Absolute Maximum Rating

Parameter	Value	Unit
RMS current*	29**(240Vac) / 58**(120Vac)	mA
Power Dissipation***	4.5	W
LED Junction Temperature (T _J)	125	°C
Operating Temperature Range (T _{OPR})	-40 ~ 85	°C
Storage Temperature (T _{STG})	-40 ~ 120	°C
ESD Sensitivity	± 3,000V HBM	-

*RMS (Root mean square) current indicates AC operation at 50~60Hz

** Maximum current that can be fed into LEDs depends on their configuration. Refer to p.6 and p.13

*** Average power dissipation of LED connected to AC power source without any ballast components.

3. Characteristics

1) Electro-Optical properties (T_a = 25 °C)

Parameter	Symbol	I _F =22mA(rms) / 220~240Vac* I _F =44mA(rms) / 100~120Vac**			Max Operation	Unit
		Min.	Typ.	Max.	Typ.	
Luminous Flux	Φ _V	240	290	-	365	lm
CCT	CT	-	3500	-	3500	K
CRI	Ra	80	83	-	83	-
Power Dissipation***	P	3.3			4.5	W
Operating Frequency	f _o	50/60				Hz

※ Tolerance : ±10%

*Max 29mA (RMS) current is allowed by 220~240Vac configuration. Refer to [Register Table] on p.6.

**Max 58mA (RMS) current is allowed by 100~120Vac configuration. Refer to [Register Table] on p.6.

***Average power dissipation of PKG connected to AC power source without any ballast components.

2) Chromaticity Coordinates ($T_a = 25 \text{ }^\circ\text{C}$)

< CIE 1931 Chromaticity diagram >

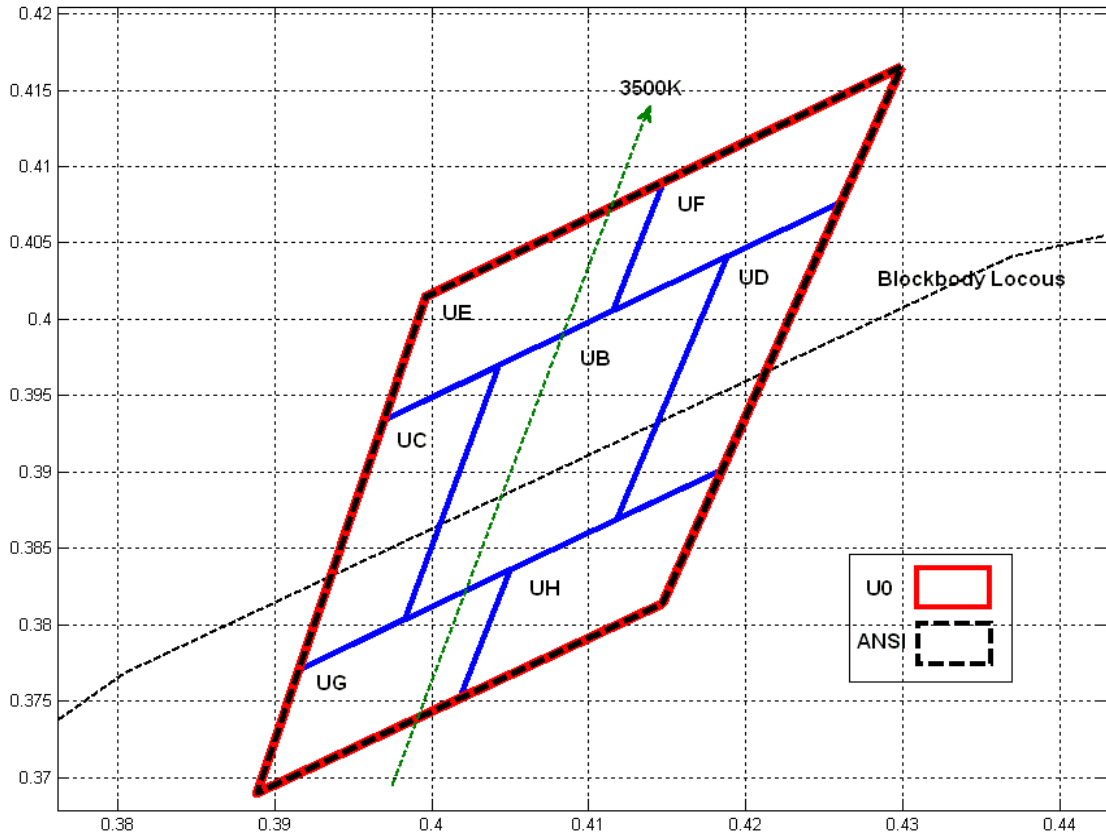

• 3500K

TABLE	Rank	CIE X	CIE Y	Rank	CIE X	CIE Y
3500K	UB	0.4188	0.4042	UF	0.4299	0.4165
		0.4042	0.3970		0.4148	0.4090
		0.3983	0.3803		0.4115	0.4005
		0.4118	0.3869		0.4261	0.4077
	UC	0.4042	0.3970	UG	0.4050	0.3837
		0.3969	0.3934		0.3916	0.3771
		0.3916	0.3771		0.3889	0.3690
		0.3983	0.3803		0.4018	0.3752
	UD	0.4261	0.4077	UH	0.4185	0.3902
		0.4188	0.4042		0.4050	0.3837
		0.4118	0.3869		0.4018	0.3752
		0.4185	0.3902		0.4147	0.3814
	UE	0.4148	0.4090	ANSI C78.377	0.4813	0.4319
		0.3996	0.4015		0.4562	0.4260
		0.3969	0.3934		0.4373	0.3944
		0.4115	0.4005		0.4593	0.4319

3) Luminous Flux ($T_a = 25\text{ }^\circ\text{C}$) (Unit, lm)

Parameter	Symbol	3.3W* Operation 22mA(rms) / 220Vac 44mA(rms) / 110Vac				4.5W** Operation 29mA(rms) / 220Vac 58mA(rms) / 110Vac			CCT	
		Rank	Min.	Typ.	Max.	Min.	Typ.	Max.		
Luminous Flux	Φ_V	VZ	V1	240	-	260	285	-	310	3500K
			W1	260	-	280	310	-	340	
			X1	280	-	300	340	-	365	
			01	300	-	-	365	-	-	

※ Tolerance : $\pm 10\%$

* Reference binning is done @ $I_F=22\text{mA(rms)}$, 3.3W.

** Luminous flux at 4.5W operation is provided by statistical correlation with luminous flux at 3.3W operation.

4) V_F Bin ($T_a = 25\text{ }^\circ\text{C}$)

Symbol	Condition	Rank	Min.	Typ.	Max.	Unit	
V_f^*	$I_F = 22\text{mA(rms)}$	S0	F1	185	-	195	Vac (rms)
			F3	195	-	200	
			F5	200	-	208	

※ Tolerance : $\pm 5\text{V}$

* The LED is directly connected to a test source without any additional components, when measured. The test source imposes sinusoidal current waves at 60Hz (22mA rms) across the LED, and V_f is measured in RMS.

5) Resistor Table

Vin (RMS)	Vf Bin	Target PKG Power Dissipation*		
		3.3W @ 44mA	4.0W @ 53mA	4.5W @ 58mA
100Vac	F1	330 Ω	240 Ω	200 Ω
	F3	300 Ω	230 Ω	190 Ω
	F5	270 Ω	220 Ω	180 Ω
110Vac	F1	560 Ω	430 Ω	360 Ω
	F3	510 Ω	410 Ω	360 Ω
	F5	460 Ω	390 Ω	360 Ω
120Vac	F1	800 Ω	620 Ω	560 Ω
	F3	750 Ω	620 Ω	545 Ω
	F5	700 Ω	620 Ω	530 Ω

Vin (RMS)	Vf Bin	Target PKG Power Dissipation*		
		3.3W @ 22mA	4.0W @ 26.5mA	4.5W @ 29mA
220Vac	F1	2.2 KΩ	1.7 KΩ	1.5 KΩ
	F3	2.1 KΩ	1.65 KΩ	1.46 KΩ
	F5	2.0 KΩ	1.6 KΩ	1.43 KΩ
230Vac	F1	2.62 KΩ	2.1 KΩ	1.9 KΩ
	F3	2.56 KΩ	2.05 KΩ	1.85 KΩ
	F5	2.5 KΩ	2.0 KΩ	1.8 KΩ
240Vac	F1	3.1 KΩ	2.5 KΩ	2.2 KΩ
	F3	3.0 KΩ	2.5 KΩ	2.2 KΩ
	F5	2.9 KΩ	2.5 KΩ	1.2 KΩ

※ LED Power dissipation tolerance : ±7%

* Proper selection of resistor values should be made for LEDs to be driven at the power consumption level specified above with acceptable tolerance. The table summarizes recommended resistor values for the mains voltages by country, and the LED's Vf bin.

HV-AC LED can be wired in two types of configuration : one is serial connection to be applicable to the mains of 220~240Vac, and the other is parallel connection to the mains of 100~120Vac. Each configuration is implemented by foot print pattern, on which the LED is mounted. For the recommended foot print design, see "8.circuit design section" on p.13.

4. Typical Characteristic Graphs

1) AC voltage operating characteristic

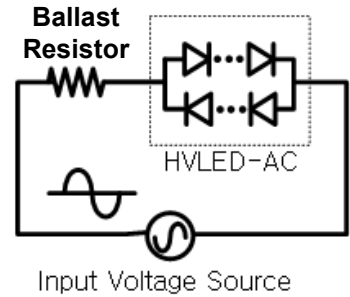
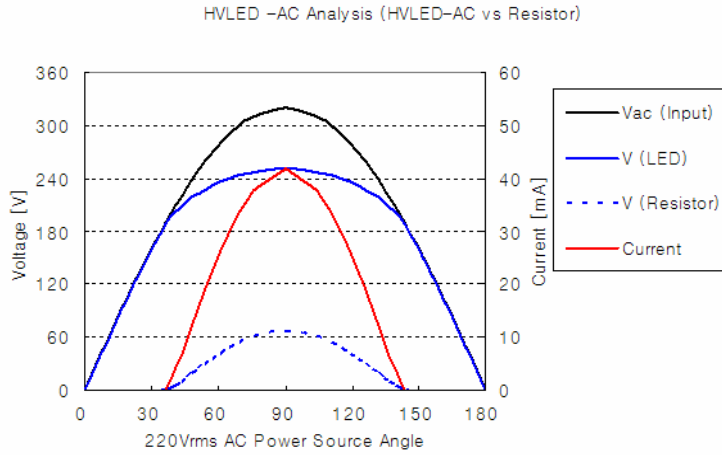

$$\text{Total Power Consumption} = \text{Power_LED} + \text{Power_Resistor}$$

$$\text{Power_LED} = \text{Total Power} - I^2R$$

< Power consumption vs. Operating current >

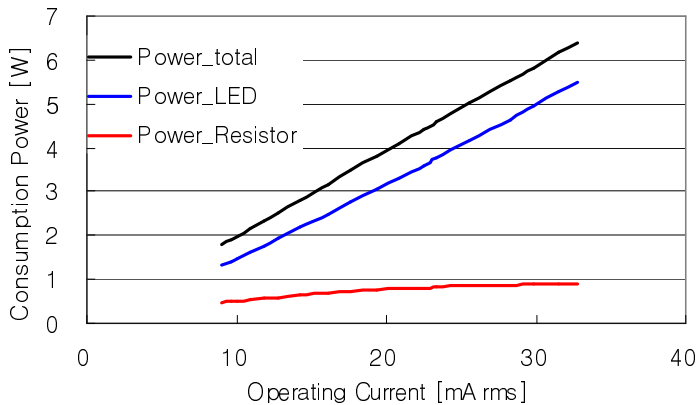

< LED Input Power vs. Generated Heat >

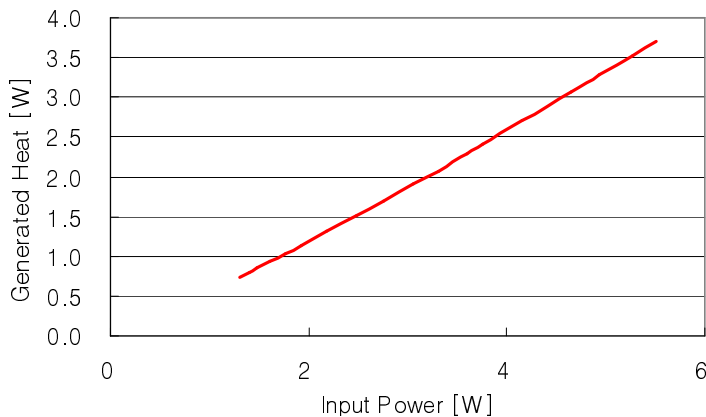

※ Total Thermal dissipation = LED + Resistor

Thermal dissipation of the LED is the vertical axis of the above graph.

Thermal dissipation of the resistor is $\text{Current}^2 \times \text{Resistance}$.

Proper resistor value and type must be selected depending on the operating condition.

2) IV characteristic (operating in AC voltage, $T_a = 25\text{ }^\circ\text{C}$)

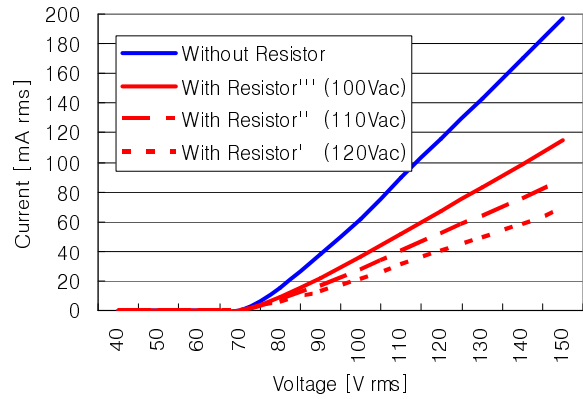
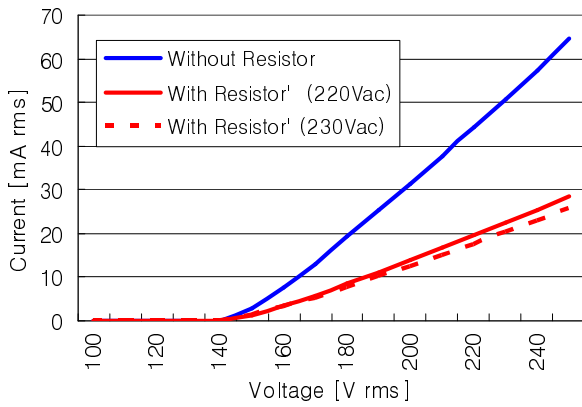

3) Optical characteristic (operating in AC voltage, $T_a = 25\text{ }^\circ\text{C}$)

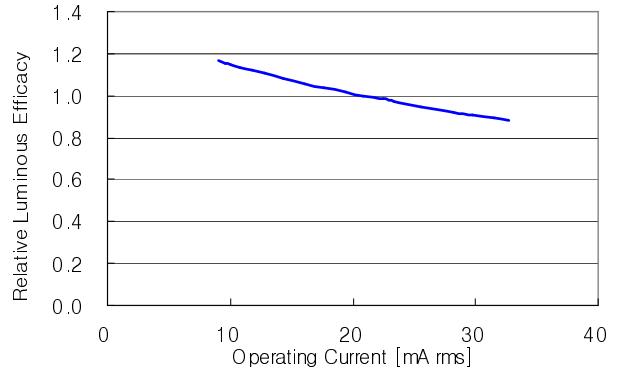
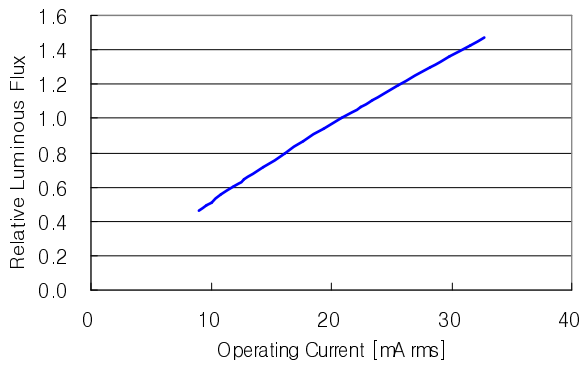

4) Thermal characteristic (operating in AC voltage, $T_a = 25\text{ }^\circ\text{C}$)

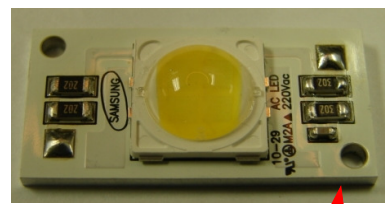
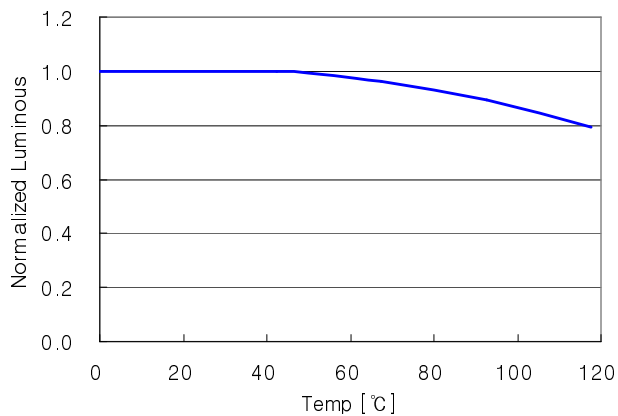

Temperature measurement point

※ Temperature is measured on bottom surface of metal PCB with ballast resistors mounted.

5) Typical Spatial Distribution

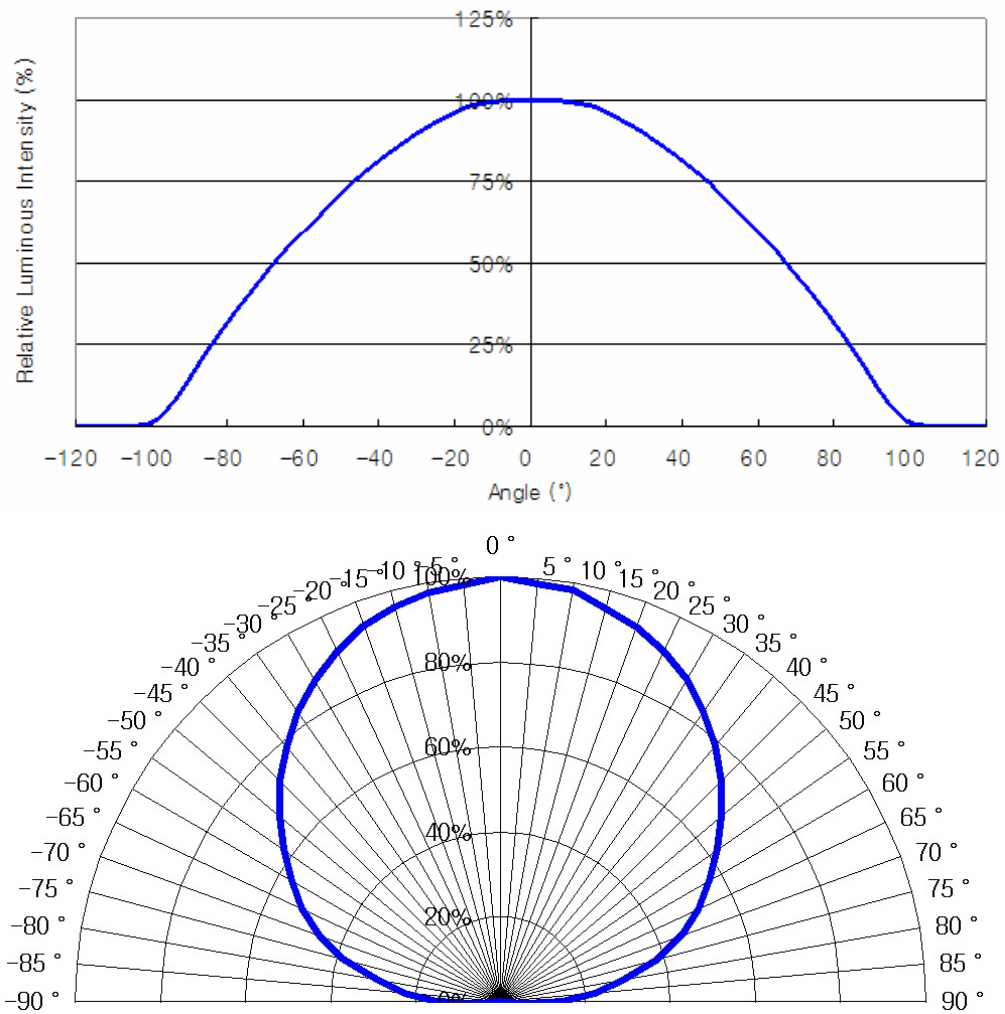

6) Spectrum Distribution

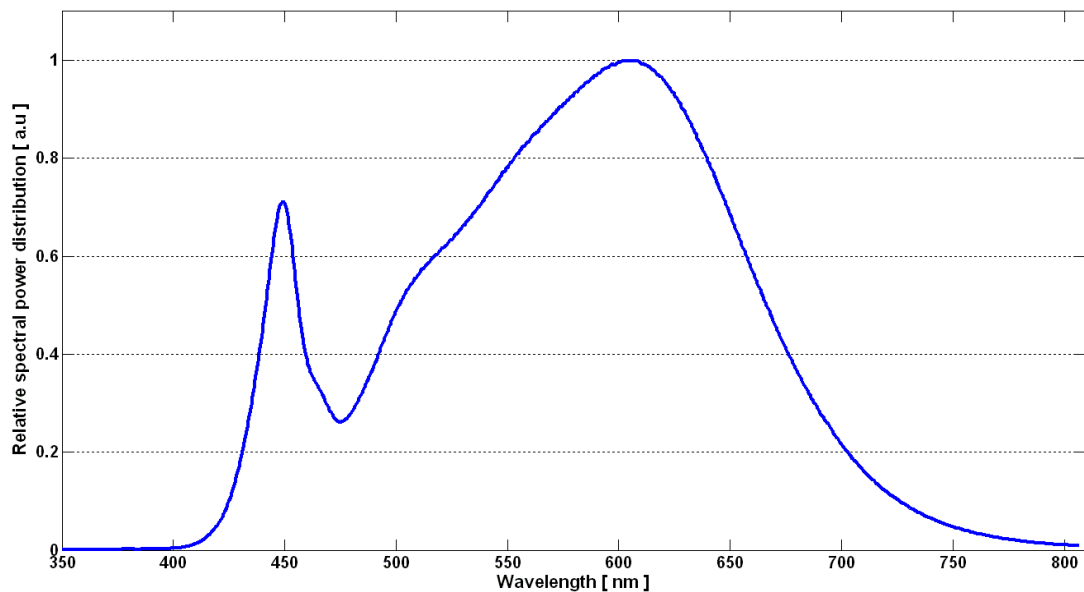

5. Outline Drawing and Pad Configuration

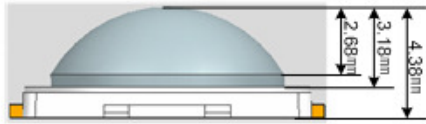

Unit : mm
Tolerance : ±0.1

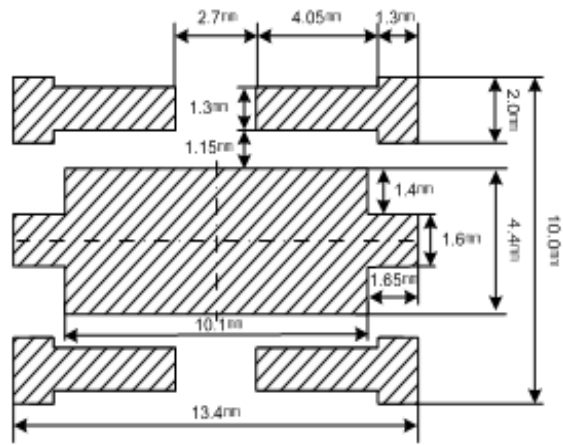
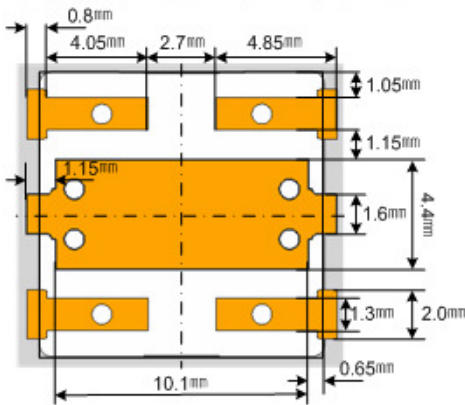
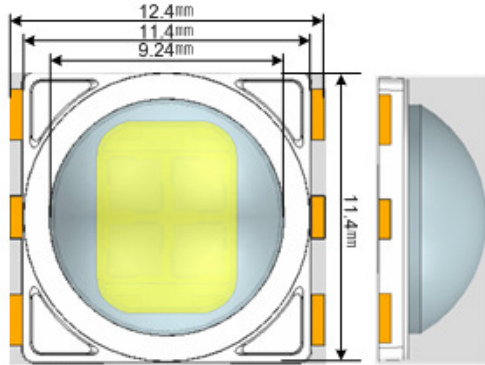

Recommended PCB Solder Pad

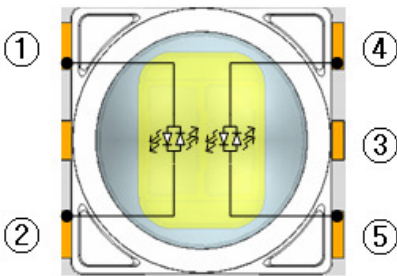

Top View

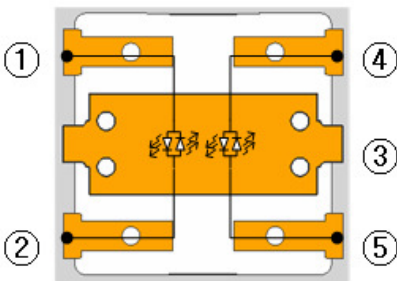
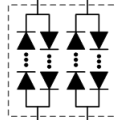

Bottom View

Pad	Function
①	Bipolarity
②	Bipolarity
③	Thermal (Electrically Isolated)
④	Bipolarity
⑤	Bipolarity

Pick and Place

- Do not place pressure on the encapsulating resin
It is recommended to use a pick&place nozzle with inside diameter at 9.2mm
- The maximum compressing force is 20N on the polymer

6. Solder Conditions

1) Reflow Conditions (Pb-Free)

Reflow Frequency : 2 time max.

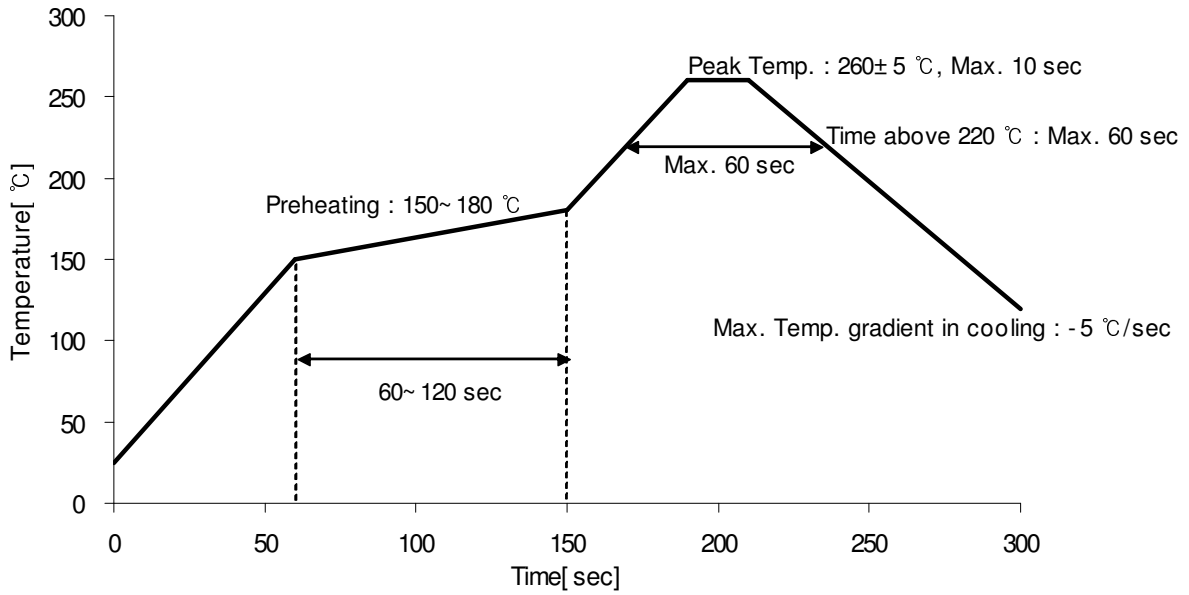

2) For Manual Soldering

Not more than 5 seconds @Max. 300 °C, under soldering iron.

7. Reliability Test Items and Conditions

1) Test Items

Test Items	Test Conditions	Test Hours/Cycles
Room Temperature life test	25°C, IF = Max AC 25mA(rms)	1,000 h
High Temperature humidity life test	85°C, 85% RH, IF = Max AC 25mA(rms)	1,000 h
High Temperature life test	85°C, IF = Max AC 25mA(rms)	1,000 h
Low Temperature life test	- 40°C, IF = Max AC25mA(rms)	1,000 h
High Temperature Storage	120°C	1,000 h
Low Temperature Storage	- 40°C	1,000 h
Thermal Shock	- 40 / 120°C, each 30 min	200 cycles
Temperature humidity Cycle On/Off test	- 40 / 85°C, each 20 min, 100 min transfer Power On/off each 5 min, AC 20 mA	100 cycles
Reflow (Pb- Free)	Peak 260±5°C for 10 sec	3 times
ESD(HBM)	R1 : 10 MΩ , R2 : 1.5 kΩ , C : 100 pF	5 times (± 2 kV)
Surge	Line to Line	2 kV

2) Criteria for Failure

Item	Symbol	Test Condition	Limit	
			Min	Max
Forward Voltage	V _F	I _F = 22 mA(rms)	-	U.S.L.*1.2
Luminous Flux	Φ _V	I _F = 22 mA(rms)	L.S.L.*0.7	-

* U.S.L : Upper Standard Level, L.S.L : Lower Standard Level

8. Circuit Design - Package and PCB

As illustrated below, two different configurations are possible depending on electric mains to which the LED to be connected.

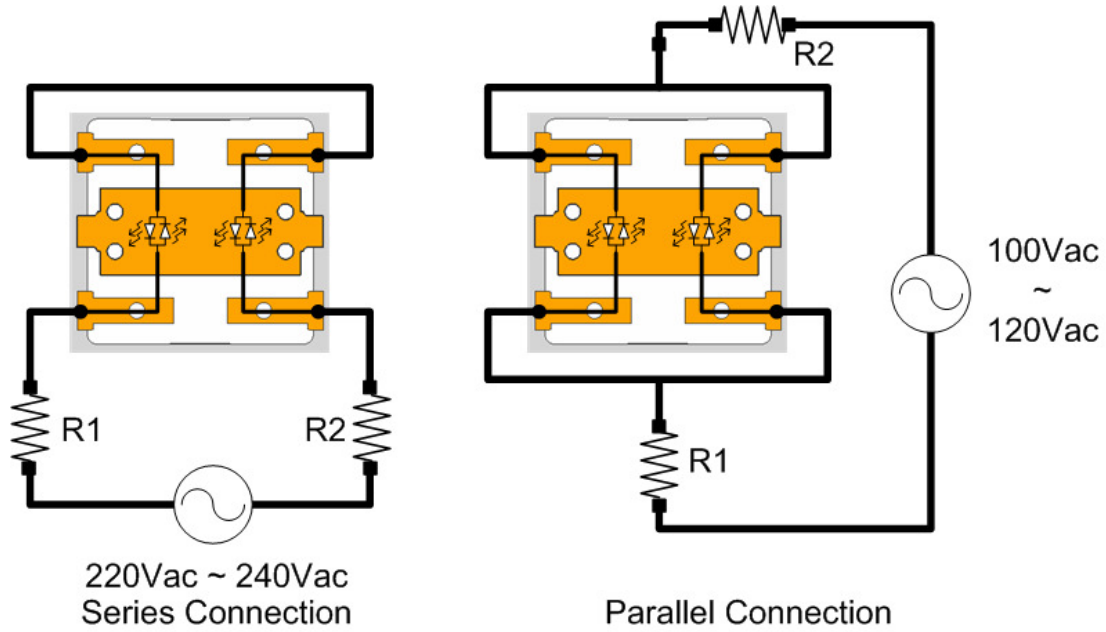

Schematic Circuit Connection (Example)

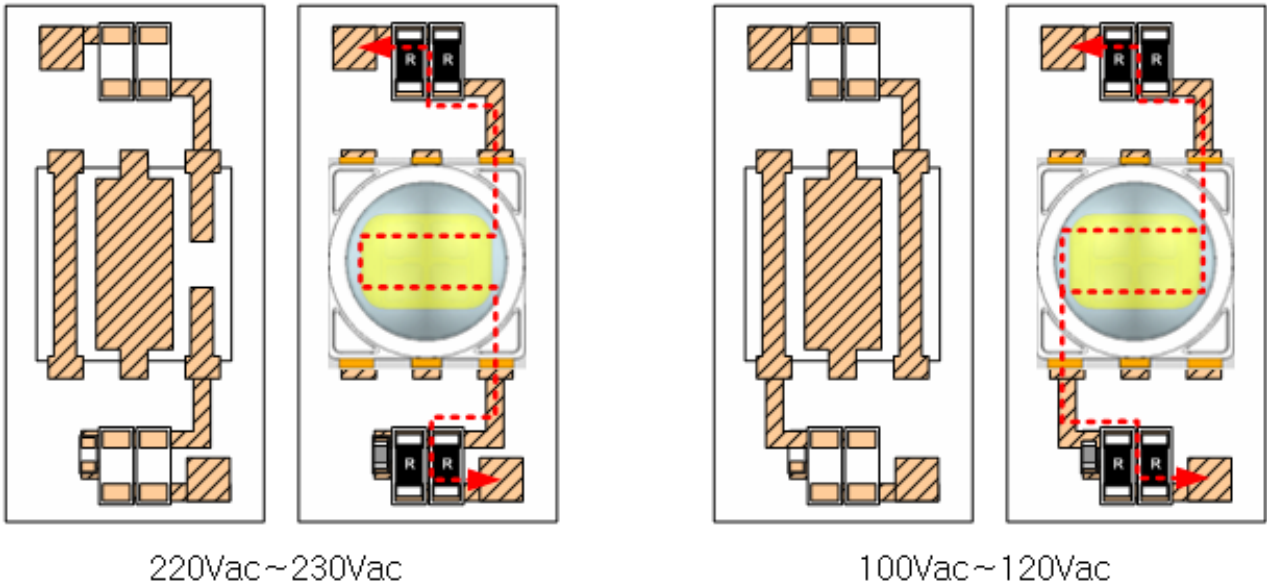

PCB Pattern Circuit (Example)

To improve protection against surge, two pairs of identical resistors connected in parallel are symmetrically added to the LED so that total equivalent resistance, the sum of R1 and R2, is equal to the selected value in p.6.

9. Taping Dimension

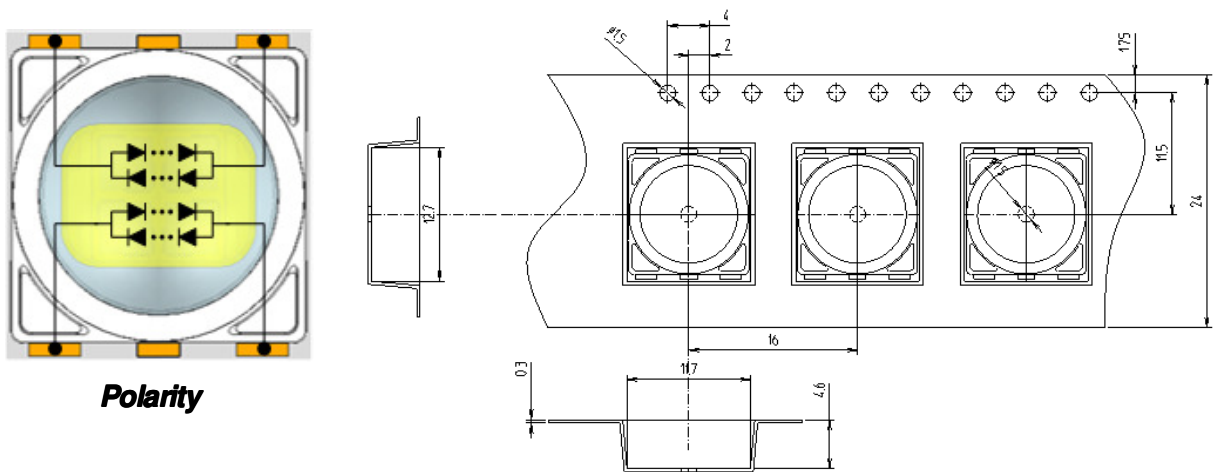

End			Start
More than 100 mm Unloaded tape	Mounted with LED	More than (100~200)mm Unloaded tape	Leading part more than (200~400)mm

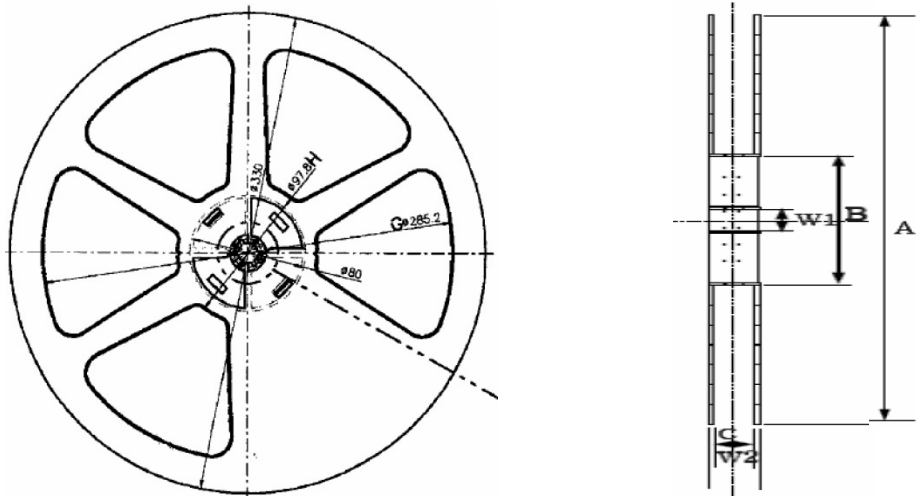

Symbol	A	B	C	W1	W2
Dimension(mm)	330 ± 1	80 ± 1	25 ± 0.5	13 ± 0.3	29.5 ± 1

- (1) Quantity : 800 Pcs / 13" Reel.
- (2) Cumulative Tolerance : Cumulative Tolerance/10 pitches is less than ±0.2 mm
- (3) Adhesion Strength of Cover Tape : Adhesion strength to be 0.1-0.7N when the cover tape is turned off from the carrier tape at 10 °C angle to be the carrier tape.
- (4) Packaging : P/N, Manufacturing data Code No. and quantity to be indicated on a damp proof Package

10. Label Structure



Rank Code

/S0/ : VF Rank (refer to page 5)

/V0/ : Chromaticity Coordinate Rank, CIE (refer to page 4)

/VZ/ : Luminous Flux (refer to page 5)

11. Lot Number

The Lot number is composed of the following characters

●◎◇◆□■△△△ / |▲▲▲ / 800PCS

● : Production Site (S:SAMSUNG LED, G:Gosin China)

◎ : L (LED)

◇ : Product State (A:Normality, B:Bulk, C:First Production, R:Reproduction, S:Sample)

◆ : Year (S:2008, T:2009, U:2010...)

□ : Month (1 ~ 9, A, B)

■ : Day (1 ~ 9, A, B ~ V)

△ : SAMSUNG LED Product Number (1 ~ 999)

▲ : Reel Number (1 ~ 999)

12. Reel Packing Structure

1) Reel

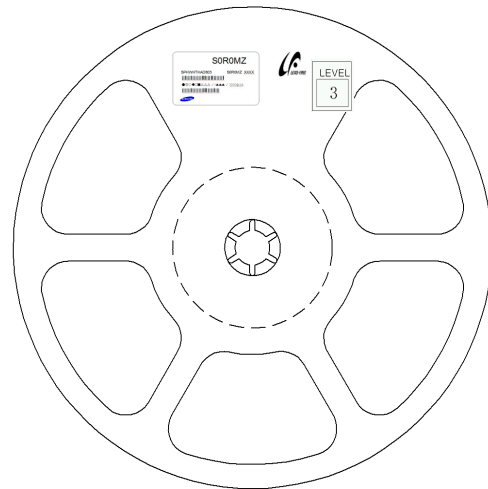
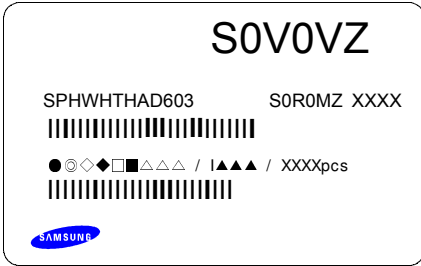

2) Aluminum Bag

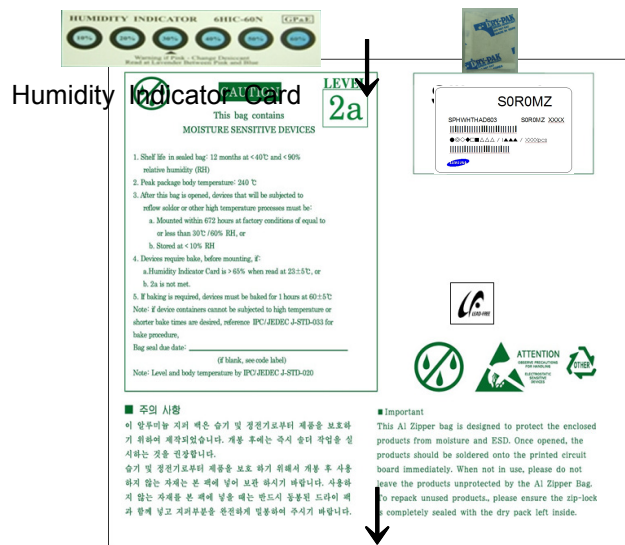
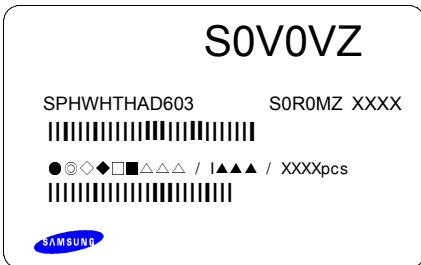

3) Inner Box

Material : Paper(SW3B(B))

TYPE	SIZE(mm)		
	L	W	H
13inch	335	45	335

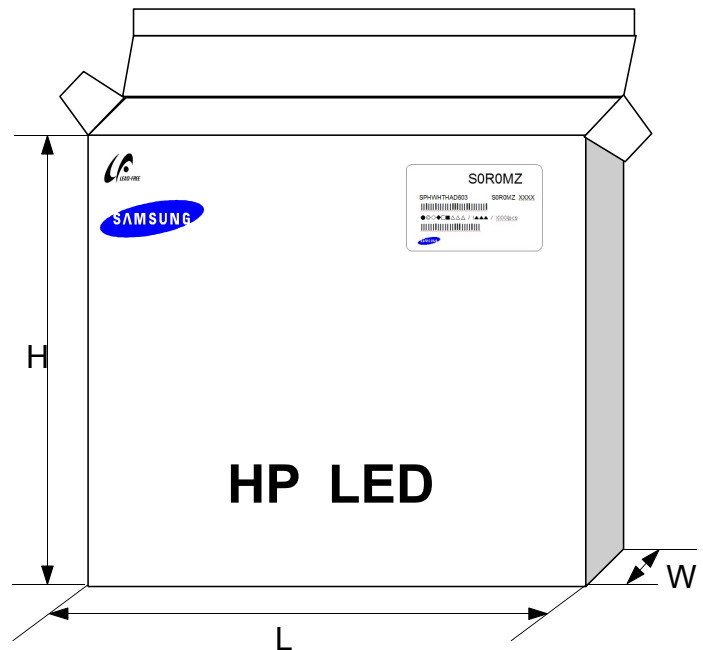
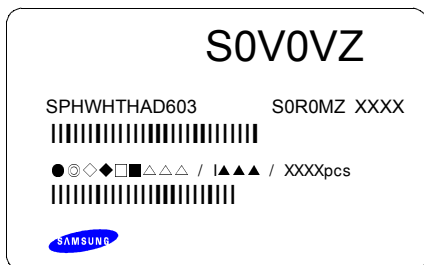

4) Carton Box

Material : Paper(SW3B(B))

TYPE	SIZE(mm)		
	L	W	H
13inch	350	350	350

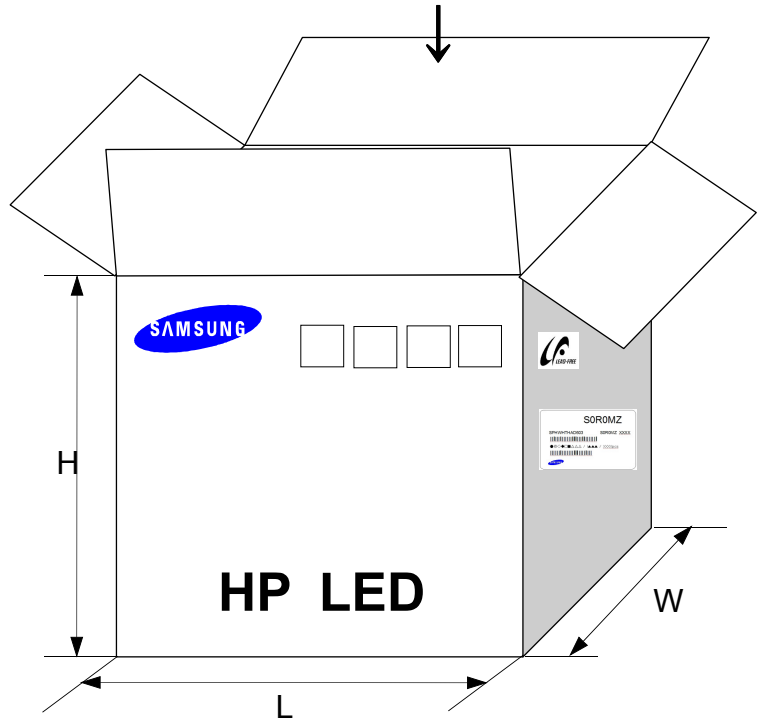
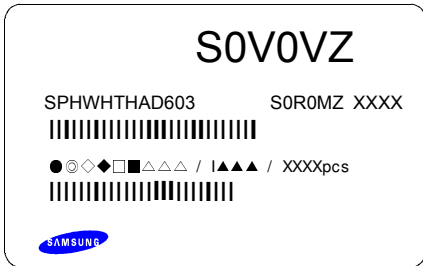

13. Aluminum Packing Bag



CAUTION

This bag contains
MOISTURE SENSITIVE DEVICES

LEVEL
2a

1. Shelf life in sealed bag: 12 months at 40°C and 90% relative humidity (RH)
2. Peak package body temperature: 240°C
3. After this bag is opened, devices that will be subjected to reflow solder or other high temperature processes must be:
 - a. Mounted within 672 hours at factory conditions of equal to or less than 30°C / 60% RH, or
 - b. Stored at 10% RH
4. Devices require bake, before mounting, if:
 - a. Humidity Indicator Card is > 65% when read at $23 \pm 5^{\circ}\text{C}$, or
 - b. 2a is not met.
5. If baking is required, devices must be baked for 1 hours at $60 \pm 5^{\circ}\text{C}$

Note: if device containers cannot be subjected to high temperature or shorter bake times are desired, reference IPC/JEDEC J-STD-033 for bake procedure,

Bag seal due date: _____
(if blank, see code label)

Note: Level and body temperature by IPC/JEDEC J-STD-020

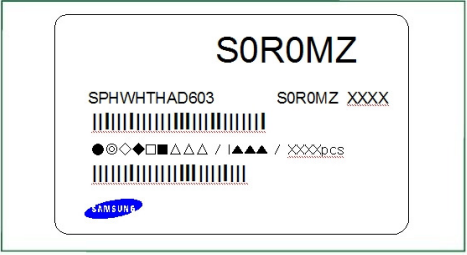

주의 사항

이 알루미늄 지퍼 백은 습기 및 정전기로부터 제품을 보호하기 위하여 제작되었습니다. 개봉 후에는 즉시 솔더 작업을 실시하는 것을 권장합니다.

습기 및 정전기로부터 제품을 보호 하기 위해서 개봉 후 사용하지 않는 자재는 본 팩에 넣어 보관 하시기 바랍니다. 사용하지 않는 자재를 본 팩에 넣을 때는 반드시 동봉된 드라이 팩과 함께 넣고 지퍼부분을 완전하게 밀봉하여 주시기 바랍니다.

Important

This Al Zipper bag is designed to protect the enclosed products from moisture and ESD. Once opened, the products should be soldered onto the printed circuit board immediately. When not in use, please do not leave the products unprotected by the Al Zipper Bag. To repack unused products., please ensure the zip-lock is completely sealed with the dry pack left inside.

Silica gel & Humidity Indicator Card in Aluminum Packing Bag

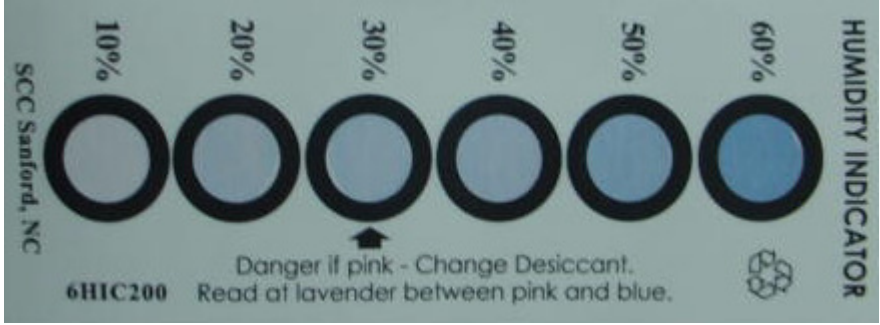

14. Precaution for Use

- 1) For over-current-proof function, customers are recommended to apply resistors to prevent sudden change of the current caused by slight shift of the voltage.
- 2) This device should not be used in any type of fluid such as water, oil, organic solvent, etc. When washing is required, IPA is recommended to use.
- 3) When the LEDs illuminate, operating current should be decided after considering the ambient maximum temperature.
- 4) LEDs must be stored in a clean environment. If the LEDs are to be stored for 3 months or more after being shipped from SAMSUNG LED, they should be packed by a sealed container with nitrogen gas injected. (Shelf life of sealed bags : 12 months, temp. 0~40℃, 20~70%RH)
- 5) After storage bag is open, device subjected to soldering, solder reflow, or other high temperature processes must be:
 - a. Mounted within 168 hours (7days) at an assembly line with a condition of no more than 30℃/60%RH,
 - b. Stored at <10% RH.
- 6) Repack unused Products with anti-moisture packing, fold to close any opening and then store in a dry place.
- 7) Devices require baking before mounting, if humidity card reading is >60% at 23±5℃.
- 8) Devices must be baked for 24hours at 65±5℃, if baking is required.
- 9) The LEDs are sensitive to the static electricity and surge. It is recommended to use a wrist band or anti-electrostatic glove when handling the LEDs.

If voltage exceeding the absolute maximum rating is applied to LEDs, it may cause damage or even destruction to LED devices.

Damaged LEDs may show some unusual characteristics such as increase in leak current, lowered turn-on voltage, or abnormal lighting of LEDs at low current.

- 10) When handling LED with tweezers, the LED Should only be held by the polymer body, not by the encapsulant or LENS.

- 11) The use of appropriate nozzle for the LED recommended. For the recommended nozzle size, refer to the figure at the below.
Inner diameter of nozzle $\geq \Phi 9.2\text{mm}$

- 12) Do not stack assembled PCBs together. Since silicone is a soft material, abrasion between two PCB assembled with silicone encapsulated LED might cause catastrophic failure of the LEDs due to damage to encapsulant and wire and LED detachment.

15. Hazard Substance Analysis

**Test Report No. F690501/LF-CTSAYAA11-02161**

Issued Date: January 21, 2011

Page 1 of 5

To: SAMSUNG LED CO., LTD.
 314, Maetan-dong
 Yeongtong-gu
 Suwon-city
 GYEONGGI-DO 443-370
 Korea

The following merchandise was submitted and identified by the client as :

SGS File No. : AYAA11-02161
Product Name : HV_AC LED PKG
Item No./Part No. : N/A
Received Date : Jan 18, 2011
Test Period : Jan 19, 2011 to Jan 20, 2011
Test Performed : SGS Testing Korea tested the sample(s) selected by applicant with following results
Test Results : For further details, please refer to following page(s)
Comments : By the applicant's specific request, the sampling and testing was performed only for the part indicated in the photo without disassembly.

Timothy Jeon
 Jinhee Kim
 Cindy Park
 Jerry Jung/ Testing Person

SGS Testing Korea Co. Ltd.**Jeff Jang / Chemical Lab Mgr**

This document is issued by the Company subject to its General Conditions of Service printed overleaf, available on request or accessible at www.sgs.com/terms-and-conditions.htm and, for electronic format documents, subject to Terms and Conditions for Electronic Documents at www.sgs.com/terms_e-document.htm. Attention is drawn to the limitation of liability, indemnification and jurisdiction issues defined therein. Any holder of this document is advised that information contained hereon reflects the Company's findings at the time of its intervention only and within the limits of Client's instructions, if any. The Company's sole responsibility is to its Client and this document does not constitute parties to a transaction from exceeding all their rights and obligations under the transaction documents. This document cannot be reproduced except in full, without prior written approval of the Company. Any unauthorized alteration, forgery or falsification of the content or appearance of this document is unlawful and offenders may be prosecuted to the fullest extent of the law. Unless otherwise stated the results shown in this test report refer only to the sample(s) tested and such sample(s) are retained for 180 days only.

F052 Version3

SGS Testing Korea Co., Ltd.

322, The O valley, 555-9, Hogye-dong, Dongan-gu, Anyang-si, Gyeonggi-do, Korea 431-080
 T +82 (0)31 4608 000 F +82 (0)31 4608 059 <http://www.sgslab.co.kr>, www.kr.sgs.com/greenlab

Member of the SGS Group (Société Générale de Surveillance)



Test Report No. F690501/LF-CTSAYAA11-02161

Issued Date: January 21, 2011

Page 2 of 5

Sample No. : AYAA11-02161.001
Sample Description : HV_AC LED PKG
Item No./Part No. : N/A
Comments : Materials are Copper, Silicone.

Heavy Metals

Test Items	Unit	Test Method	MDL	Results
Cadmium (Cd)	mg/kg	With reference to IEC 62321:2008, ICP	0.5	N.D.
Lead (Pb)	mg/kg	With reference to IEC 62321:2008, ICP	5	N.D.
Mercury (Hg)	mg/kg	With reference to IEC 62321:2008, ICP	2	N.D.
Hexavalent Chromium (Cr VI)	mg/kg	With reference to IEC 62321:2008, UV-VIS	1	N.D.

Flame Retardants-PBBs/PBDEs

Test Items	Unit	Test Method	MDL	Results
Monobromobiphenyl	mg/kg	With reference to IEC 62321:2008, GC-MS	5	N.D.
Dibromobiphenyl	mg/kg	With reference to IEC 62321:2008, GC-MS	5	N.D.
Tribromobiphenyl	mg/kg	With reference to IEC 62321:2008, GC-MS	5	N.D.
Tetrabromobiphenyl	mg/kg	With reference to IEC 62321:2008, GC-MS	5	N.D.
Pentabromobiphenyl	mg/kg	With reference to IEC 62321:2008, GC-MS	5	N.D.
Hexabromobiphenyl	mg/kg	With reference to IEC 62321:2008, GC-MS	5	N.D.
Heptabromobiphenyl	mg/kg	With reference to IEC 62321:2008, GC-MS	5	N.D.
Octabromobiphenyl	mg/kg	With reference to IEC 62321:2008, GC-MS	5	N.D.
Nonabromobiphenyl	mg/kg	With reference to IEC 62321:2008, GC-MS	5	N.D.
Decabromobiphenyl	mg/kg	With reference to IEC 62321:2008, GC-MS	5	N.D.
Monobromodiphenyl ether	mg/kg	With reference to IEC 62321:2008, GC-MS	5	N.D.
Dibromodiphenyl ether	mg/kg	With reference to IEC 62321:2008, GC-MS	5	N.D.
Tribromodiphenyl ether	mg/kg	With reference to IEC 62321:2008, GC-MS	5	N.D.
Tetrabromodiphenyl ether	mg/kg	With reference to IEC 62321:2008, GC-MS	5	N.D.
Pentabromodiphenyl ether	mg/kg	With reference to IEC 62321:2008, GC-MS	5	N.D.
Hexabromodiphenyl ether	mg/kg	With reference to IEC 62321:2008, GC-MS	5	N.D.
Heptabromodiphenyl ether	mg/kg	With reference to IEC 62321:2008, GC-MS	5	N.D.
Octabromodiphenyl ether	mg/kg	With reference to IEC 62321:2008, GC-MS	5	N.D.
Nonabromodiphenyl ether	mg/kg	With reference to IEC 62321:2008, GC-MS	5	N.D.
Decabromodiphenyl ether	mg/kg	With reference to IEC 62321:2008, GC-MS	5	N.D.

NOTE: (1) N.D. = Not detected. (<MDL)
 (2) mg/kg = ppm
 (3) MDL = Method Detection Limit
 (4) - = No regulation
 (5) ** = Qualitative analysis (No Unit)
 (6) * = Boiling-water-extraction:
 Negative = Absence of CrVI coating
 Positive = Presence of CrVI coating; the detected concentration in boiling-water-extraction solution is equal or greater than 0.02 mg/kg with 50 cm2 sample surface area.

This document is issued by the Company subject to its General Conditions of Service printed overleaf, available on request or accessible at www.sgs.com/terms_and_conditions.htm and, for electronic format documents, subject to Terms and Conditions for Electronic Documents at www.sgs.com/terms_e-documentation.htm. Attention is drawn to the limitation of liability, indemnification and jurisdiction issues defined therein. Any holder of this document is advised that information contained herein reflects the Company's findings at the time of its intervention only and within the limits of Client's instructions, if any. The Company's sole responsibility is to its Client and this document does not constitute parties to a transaction from exercising all their rights and obligations under the transaction documents. This document cannot be reproduced except in full, without prior written approval of the Company. Any unauthorized alteration, forgery or falsification of the content or appearance of this document is unlawful and offenders may be prosecuted to the fullest extent of the law. Unless otherwise stated the results shown in this test report refer only to the sample(s) tested and such sample(s) are retained for 180 days only.



Test Report No. F690501/LF-CTSAYAA11-02161

Issued Date: January 21, 2011

Page 3 of 5

Sample No. : AYAA11-02161.001
Sample Description : HV_AC LED PKG
Item No./Part No. : N/A
Comments : Materials are Copper, Silicone.

Halogen Contents

Test Items	Unit	Test Method	MDL	Results
Bromine(Br)	mg/kg	BS EN 14582:2007 , IC	30	N.D.
Chlorine(Cl)	mg/kg	BS EN 14582:2007 , IC	30	N.D.
Fluorine(F)	mg/kg	BS EN 14582:2007 , IC	30	N.D.
Iodine(I)	mg/kg	BS EN 14582:2007 , IC	50	N.D.

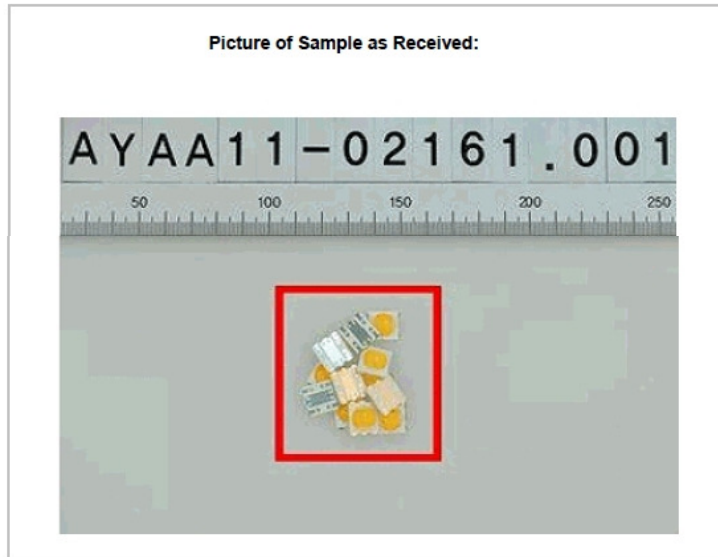

NOTE:

- (1) N.D. = Not detected.(<MDL)
- (2) mg/kg = ppm
- (3) MDL = Method Detection Limit
- (4) - = No regulation
- (5) ** = Qualitative analysis (No Unit)
- (6) * = Boiling-water-extraction:
 Negative = Absence of CrVI coating
 Positive = Presence of CrVI coating; the detected concentration in boiling-water-extraction solution is equal or greater than 0.02 mg/kg with 50 cm2 sample surface area.

This document is issued by the Company subject to its General Conditions of Service printed overleaf, available on request or accessible at www.sgs.com/terms_and_conditions.htm and, for electronic format documents, subject to Terms and Conditions for Electronic Documents at www.sgs.com/terms_e-document.htm. Attention is drawn to the limitation of liability, indemnification and jurisdiction issues defined therein. Any holder of this document is advised that information contained hereon reflects the Company's findings at the time of its intervention only and within the limits of Client's instructions, if any. The Company's sole responsibility is to its Client and this document does not constitute parties to a transaction from ascertaining all their rights and obligations under the transaction documents. This document cannot be reproduced except in full, without prior written approval of the Company. Any unauthorized alteration, forgery or falsification of the content or appearance of this document is unlawful and offenders may be prosecuted to the fullest extent of the law. Unless otherwise stated the results shown in this test report refer only to the sample(s) tested and such sample(s) are retained for 180 days only.

X-ON Electronics

Largest Supplier of Electrical and Electronic Components

Click to view similar products for [Standard LEDs - SMD category](#):

Click to view products by [Samsung manufacturer](#):

Other Similar products are found below :

[LTST-C19GD2WT](#) [LTST-N683GBEW](#) [597-3006-607F](#) [597-3403-607F](#) [LTW-K140SZR40](#) [LTW-M140ZVS](#) [598-8110-100F](#) [598-8170-100F](#)
[598-8610-202F](#) [7012X7](#) [AAAF5060QBFSEEZGS](#) [12-22SURSYGC/S530-A3/E2/TR8](#) [1383SURT/S530-A3/TR1\(R\)](#) [APT1608QGW](#)
[EASV1803BA0](#) [HT-F104TW-5860](#) [SML310BATT86](#) [SML-512VWT86A](#) [SML-LX0606SISUGC/A](#) [SML-LXL1307SRC-TR](#) [SML-](#)
[LXR851SIUPGUBC](#) [LT1ED53A](#) [17-21/G6C-FM1N2B/3T](#) [FAT801-S](#) [SSL-LXA227IC-TR31A](#) [AM27ZGC03](#) [APB3025SGNC](#)
[APHK1608VGCA](#) [APT2012QGW](#) [CLMVC-FKA-CA1E1L81BB7C3C3](#) [CLYBA-FKA-CFHHL9BBB7A363](#) [CMD11504UR](#) [LTW-](#)
[020ZDCG](#) [LTW-21TS5](#) [LTW-K140SZR30](#) [HSMY-C177](#) [HT-121UYG-4739](#) [UYGT801-S](#) [KVH1C100MF6R](#) [42-21SYGC/S530-E1/TR8](#)
[YGFR411-H](#) [597-2311-402F](#) [5973212407NF](#) [597-3302-607F](#) [597-5202-407F](#) [598-8330-117F](#) [SAW8WA2A-L35M40-CA](#) [SML013WBDW1](#)
[SML522BUWT86](#) [SML-LX0402IC-TR](#)