



ISSUE NO :

Rev:

Product Family Data Sheet

LM302A – 3030 Middle Power LED

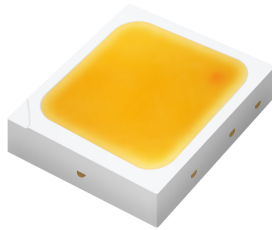
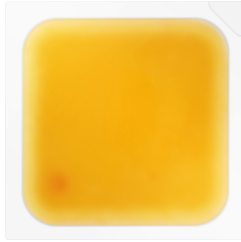

Introduction

Features

- Beam Angle : 120°
- Precondition : JEDEC Level 2a
- Dimension : 3.00 x 3.00 x 0.65 mm
- ESD withstand Voltage : up to ± 5 KV [HBM]

Applications

- INDOOR LIGHTING : Down light, LED bulb, MR/Par and Ceiling Light

PRELIMINARY

SAMSUNG ELECTRONICS

95, Samsung2-Ro, Giheung-Gu,
Yongin-City, Gyeonggi-Do 446-711, KOREA

Contents

1. Product Code Information	-----	3
2. Characteristics	-----	9
3. Typical Characteristics Graph	-----	10
4. Outline Drawing & Dimension	-----	17
5. Reliability Test Items & Conditions	-----	18
6. Solder Conditions	-----	19
7. Tape & Reel	-----	20
8. Label Structure	-----	21
9. Packing Structure	-----	22
10. Precaution For Use	-----	24
11. Revision History	-----	26

PRELIMINARY

1. Product Code Information

1) Luminous Flux Bins ($T_s = 25^\circ\text{C}$)

Nominal CCT	Product Code	Flux Rank	Sorting Condition $I_m @150\text{mA}$	
			Flux Bin	Flux Range (Φ_v, I_m)
2700K	SPMWHT327FD5GBW0S0	S0	S1	94.0 ~ 102.0
			S2	102.0 ~ 110.0
			S3	110.0 ~ 118.0
3000K	SPMWHT327FD5GBV0S0	S0	S1	96.0 ~ 104.0
			S2	104.0 ~ 112.0
			S3	112.0 ~ 120.0
3500K	SPMWHT327FD5GBU0S0	S0	S1	99.0 ~ 107.0
			S2	107.0 ~ 115.0
			S3	115.0 ~ 123.0
4000K	SPMWHT327FD5GBT0S0	S0	S1	101.0 ~ 109.0
			S2	109.0 ~ 117.0
			S3	117.0 ~ 125.0
5000K	SPMWHT327FD5GBR0S0	S0	S1	107.0 ~ 115.0
			S2	115.0 ~ 123.0
			S3	123.0 ~ 131.0
5700K	SPMWHT327FD5GBQ0S0	S0	S1	103.0 ~ 111.0
			S2	111.0 ~ 119.0
			S3	119.0 ~ 127.0
6500K	SPMWHT327FD5GBP0S0	S0	S1	101.0 ~ 109.0
			S2	109.0 ~ 117.0
			S3	117.0 ~ 125.0

Notes:

SAMSUNG ELECTRONICS maintains a tolerance of $\pm 5\%$ on Luminous Flux measurements



2) Color Bins ($T_s = 25^\circ\text{C}$)
(1) Color Binning

Nominal CCT	Product Code	Color Rank	Chromaticity Bins
2700K	SPMWHT327FD5GBW0S0	W0	W1, W2, W3, W4, W5, W6, W7, W8, W9, WA, WB, WC, WD, WE, WF, WG
3000K	SPMWHT327FD5GBV0S0	V0	V1, V2, V3, V4, V5, V6, V7, V8, V9, VA, VB, VC, VD, VE, VF, VG
3500K	SPMWHT327FD5GBU0S0	U0	U1, U2, U3, U4, U5, U6, U7, U8, U9, UA, UB, UC, UD, UE, UF, UG
4000K	SPMWHT327FD5GBT0S0	T0	T1, T2, T3, T4, T5, T6, T7, T8, T9, TA, TB, TC, TD, TE, TF, TG
5000K	SPMWHT327FD5GBR0S0	R0	R1, R2, R3, R4, R5, R6, R7, R8, R9, RA
5700K	SPMWHT327FD5GBQ0S0	Q0	Q1, Q2, Q3, Q4, Q5, Q6, Q7, Q8, Q9, QA
6500K	SPMWHT327FD5GBP0S0	P0	P1, P2, P3, P4, P5, P6, P7, P8, P9, PA,

PRELIMINARY

(2) Chromaticity Region & Coordinates

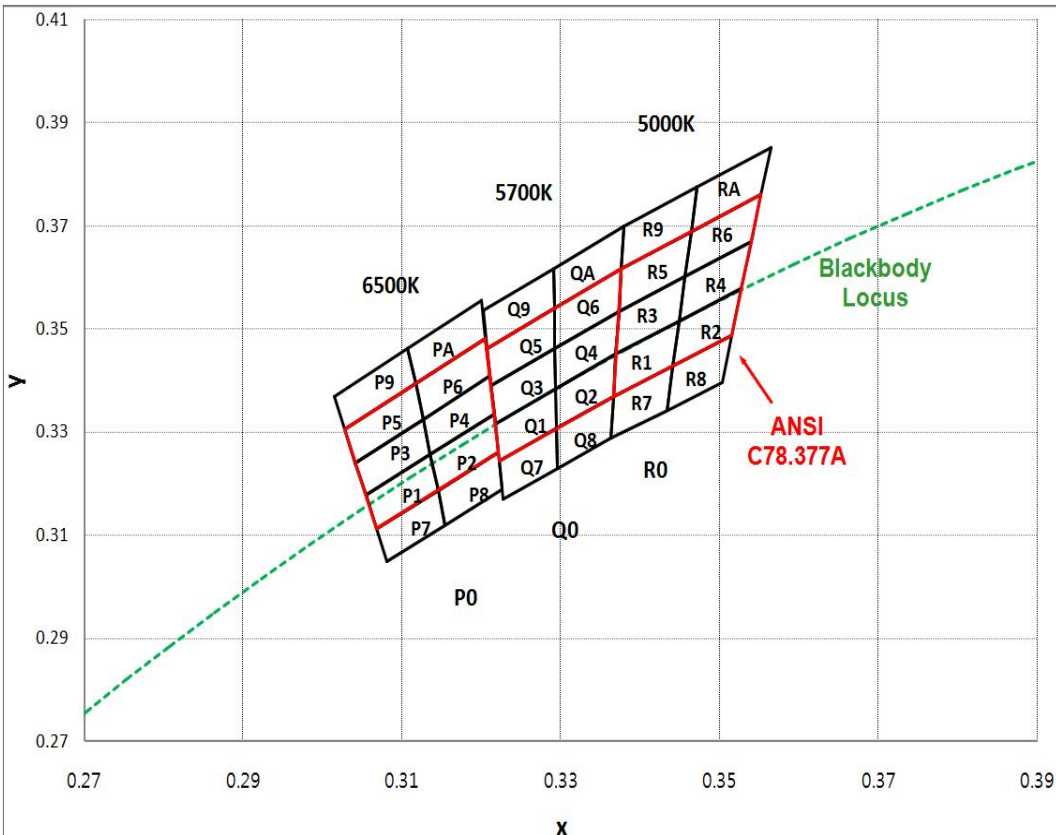
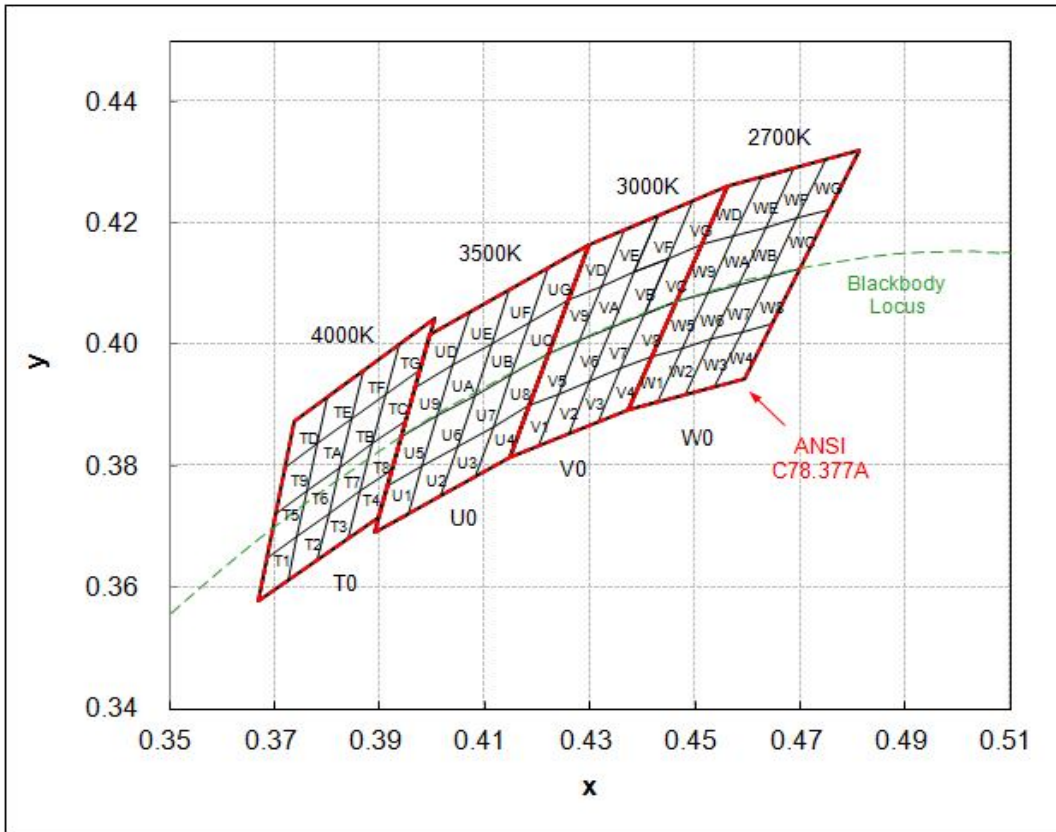

(2) Chromaticity Region & Coordinates (Continued)

Region	CIE X	CIE Y	Region	CIE X	CIE Y	Region	CIE X	CIE Y	Region	CIE X	CIE Y
W rank (2700K)						V rank (3000K)					
W1	0.4373	0.3893	W9	0.4465	0.4071	V1	0.4147	0.3814	V9	0.4221	0.3984
	0.4418	0.3981		0.4513	0.4164		0.4183	0.3898		0.4259	0.4073
	0.4475	0.3994		0.4573	0.4178		0.4242	0.3919		0.4322	0.4096
	0.4428	0.3906		0.4523	0.4085		0.4203	0.3833		0.4281	0.4006
W2	0.4428	0.3906	WA	0.4523	0.4085	V2	0.4203	0.3833	VA	0.4281	0.4006
	0.4475	0.3994		0.4573	0.4178		0.4242	0.3919		0.4322	0.4096
	0.4532	0.4008		0.4634	0.4193		0.4300	0.3939		0.4385	0.4119
	0.4483	0.3919		0.4582	0.4099		0.4259	0.3853		0.4342	0.4028
W3	0.4483	0.3919	WB	0.4582	0.4099	V3	0.4259	0.3853	VB	0.4342	0.4028
	0.4532	0.4008		0.4634	0.4193		0.4300	0.3939		0.4385	0.4119
	0.4589	0.4021		0.4695	0.4207		0.4359	0.3960		0.4449	0.4141
	0.4538	0.3931		0.4641	0.4112		0.4316	0.3873		0.4403	0.4049
W4	0.4538	0.3931	WC	0.4641	0.4112	V4	0.4316	0.3873	VC	0.4403	0.4049
	0.4589	0.4021		0.4695	0.4207		0.4359	0.3960		0.4449	0.4141
	0.4646	0.4034		0.4756	0.4221		0.4418	0.3981		0.4513	0.4164
	0.4593	0.3944		0.4700	0.4126		0.4373	0.3893		0.4465	0.4071
W5	0.4418	0.3981	WD	0.4513	0.4164	V5	0.4183	0.3898	VD	0.4259	0.4073
	0.4465	0.4071		0.4562	0.4260		0.4221	0.3984		0.4299	0.4165
	0.4523	0.4085		0.4624	0.4274		0.4281	0.4006		0.4364	0.4188
	0.4475	0.3994		0.4573	0.4178		0.4242	0.3919		0.4322	0.4096
W6	0.4475	0.3994	WE	0.4573	0.4178	V6	0.4242	0.3919	VE	0.4322	0.4096
	0.4523	0.4085		0.4624	0.4274		0.4281	0.4006		0.4364	0.4188
	0.4582	0.4099		0.4687	0.4289		0.4342	0.4028		0.4430	0.4212
	0.4532	0.4008		0.4634	0.4193		0.4300	0.3939		0.4385	0.4119
W7	0.4532	0.4008	WF	0.4634	0.4193	V7	0.4300	0.3939	VF	0.4385	0.4119
	0.4582	0.4099		0.4687	0.4289		0.4342	0.4028		0.4430	0.4212
	0.4641	0.4112		0.4750	0.4304		0.4403	0.4049		0.4496	0.4236
	0.4589	0.4021		0.4695	0.4207		0.4359	0.3960		0.4449	0.4141
W8	0.4589	0.4021	WG	0.4695	0.4207	V8	0.4359	0.3960	VG	0.4449	0.4141
	0.4641	0.4112		0.4750	0.4304		0.4403	0.4049		0.4496	0.4236
	0.4700	0.4126		0.4813	0.4319		0.4465	0.4071		0.4562	0.4260
	0.4646	0.4034		0.4756	0.4221		0.4418	0.3981		0.4513	0.4164

(2) Chromaticity Region & Coordinates (Continued)

Region	CIE X	CIE Y	Region	CIE X	CIE Y	Region	CIE X	CIE Y	Region	CIE X	CIE Y
U rank (3500K)						T rank (4000K)					
U1	0.3889	0.3690	U9	0.3941	0.3848	T1	0.367	0.3578	T9	0.3702	0.3722
	0.3915	0.3768		0.3968	0.3930		0.3726	0.3612		0.3763	0.3760
	0.3981	0.3800		0.4040	0.3966		0.3744	0.3685		0.3782	0.3837
	0.3953	0.3720		0.4010	0.3882		0.3686	0.3649		0.3719	0.3797
U2	0.3953	0.3720	UA	0.4010	0.3882	T2	0.3726	0.3612	TA	0.3763	0.3760
	0.3981	0.3800		0.4040	0.3966		0.3783	0.3646		0.3825	0.3798
	0.4048	0.3832		0.4113	0.4001		0.3804	0.3721		0.3847	0.3877
	0.4017	0.3751		0.4080	0.3916		0.3744	0.3685		0.3782	0.3837
U3	0.4017	0.3751	UB	0.4080	0.3916	T3	0.3783	0.3646	TB	0.3825	0.3798
	0.4048	0.3832		0.4113	0.4001		0.3840	0.3681		0.3887	0.3836
	0.4116	0.3865		0.4186	0.4037		0.3863	0.3758		0.3912	0.3917
	0.4082	0.3782		0.4150	0.3950		0.3804	0.3721		0.3847	0.3877
U4	0.4082	0.3782	UC	0.4150	0.3950	T4	0.384	0.3681	TC	0.3887	0.3837
	0.4116	0.3865		0.4186	0.4037		0.3898	0.3716		0.395	0.3875
	0.4183	0.3898		0.4259	0.4073		0.3924	0.3794		0.3978	0.3958
	0.4147	0.3814		0.4221	0.3984		0.3863	0.3758		0.3912	0.3917
U5	0.3915	0.3768	UD	0.3968	0.3930	T5	0.3686	0.3649	TD	0.3719	0.3797
	0.3941	0.3848		0.3996	0.4015		0.3744	0.3685		0.3782	0.3837
	0.4010	0.3882		0.4071	0.4052		0.3763	0.376		0.3802	0.3916
	0.3981	0.3800		0.4040	0.3966		0.3702	0.3722		0.3736	0.3874
U6	0.3981	0.3800	UE	0.4040	0.3966	T6	0.3744	0.3685	TE	0.3782	0.3837
	0.4010	0.3882		0.4071	0.4052		0.3804	0.3721		0.3847	0.3877
	0.4080	0.3916		0.4146	0.4089		0.3825	0.3798		0.3869	0.3958
	0.4048	0.3832		0.4113	0.4001		0.3763	0.376		0.3802	0.3916
U7	0.4048	0.3832	UF	0.4113	0.4001	T7	0.3804	0.3721	TF	0.3847	0.3877
	0.4080	0.3916		0.4146	0.4089		0.3863	0.3758		0.3912	0.3917
	0.4150	0.3950		0.4222	0.4127		0.3887	0.3836		0.3937	0.4001
	0.4116	0.3865		0.4186	0.4037		0.3825	0.3798		0.3869	0.3958
U8	0.4116	0.3865	UG	0.4186	0.4037	T8	0.3863	0.3758	TG	0.3912	0.3917
	0.4150	0.3950		0.4222	0.4127		0.3924	0.3794		0.3978	0.3958
	0.4221	0.3984		0.4299	0.4165		0.395	0.3875		0.4006	0.4044
	0.4183	0.3898		0.4259	0.4073		0.3887	0.3836		0.3937	0.4001



(2) Chromaticity Region & Coordinates (Continued)

Region	CIE X	CIE Y	Region	CIE X	CIE Y
R rank (5000K)					
R1	0.3366	0.3369	R6	0.3456	0.3601
	0.3441	0.3428		0.3539	0.3669
	0.3449	0.3515		0.3551	0.3760
	0.3369	0.3451		0.3464	0.3688
R2	0.3441	0.3428	R7	0.3363	0.3287
	0.3515	0.3487		0.3433	0.3341
	0.3527	0.3578		0.3441	0.3428
	0.3449	0.3515		0.3366	0.3369
R3	0.3369	0.3451	R8	0.3433	0.3341
	0.3449	0.3515		0.3503	0.3396
	0.3456	0.3601		0.3515	0.3487
	0.3373	0.3534		0.3441	0.3428
R4	0.3449	0.3515	R9	0.3376	0.3616
	0.3527	0.3578		0.3464	0.3688
	0.3539	0.3669		0.3471	0.3775
	0.3456	0.3601		0.3379	0.3698
R5	0.3373	0.3534	RA	0.3464	0.3688
	0.3456	0.3601		0.3551	0.3760
	0.3464	0.3688		0.3564	0.3851
	0.3376	0.3616		0.3471	0.3775
Q rank (5700K)					
Q1	0.3222	0.3243	Q6	0.3292	0.3461
	0.3294	0.3306		0.3373	0.3534
	0.3293	0.3384		0.3376	0.3616
	0.3217	0.3316		0.3292	0.3539
Q2	0.3294	0.3306	Q7	0.3227	0.3170
	0.3366	0.3369		0.3295	0.3228
	0.3369	0.3451		0.3294	0.3306
	0.3293	0.3384		0.3222	0.3243
Q3	0.3217	0.3316	Q8	0.3295	0.3228
	0.3293	0.3384		0.3363	0.3287
	0.3292	0.3461		0.3366	0.3369
	0.3212	0.3389		0.3294	0.3306
Q4	0.3293	0.3384	Q9	0.3207	0.3462
	0.3369	0.3451		0.3292	0.3539
	0.3373	0.3534		0.3291	0.3617
	0.3292	0.3461		0.3202	0.3535
Q5	0.3212	0.3389	QA	0.3292	0.3539
	0.3292	0.3461		0.3376	0.3616
	0.3292	0.3539		0.3379	0.3698
	0.3207	0.3462		0.3291	0.3617

Region	CIE X	CIE Y	Region	CIE X	CIE Y
P rank (6500K)					
P1	0.3068	0.3113	P6	0.3126	0.3324
	0.3145	0.3187		0.3210	0.3408
	0.3135	0.3256		0.3205	0.3481
	0.3055	0.3177		0.3117	0.3393
P2	0.3145	0.3187	P7	0.3081	0.3049
	0.3221	0.3261		0.3154	0.3119
	0.3216	0.3334		0.3145	0.3187
	0.3135	0.3256		0.3068	0.3113
P3	0.3055	0.3177	P8	0.3154	0.3119
	0.3135	0.3256		0.3226	0.3188
	0.3126	0.3324		0.3221	0.3261
	0.3041	0.3240		0.3145	0.3187
P4	0.3135	0.3256	P9	0.3028	0.3304
	0.3216	0.3334		0.3117	0.3393
	0.3210	0.3408		0.3107	0.3461
	0.3126	0.3324		0.3015	0.3368
P5	0.3041	0.3240	PA	0.3117	0.3393
	0.3126	0.3324		0.3205	0.3481
	0.3117	0.3393		0.3200	0.3554
	0.3028	0.3304		0.3107	0.3461

MINIARY

Notes: SAMSUNG ELECTRONICS maintains ± 0.005 tolerance of Cx, Cy

2. Characteristics

1) Absolute Maximum Rating

Item	Symbol	Rating	Condition
Operating temperature range	T _{op}	-40°C ~ +85°C	-
Storage temperature range	T _{stg}	-40°C ~ +100°C	-
LED junction temperature	T _J	120°C	-
Forward Current	I _F	200 mA	-
Peak Pulsed Forward Current	I _{FP}	400 mA	Duty 1/10 pulse width 10ms
Assembly Process Temperature	-	260°C, < 10sec	-
ESD	-	5kV	HBM

2) Electro-optical Characteristics

Item	Unit	Nominal CCT	Rank	Min	Typ	Max
Forward Voltage ¹⁾ (V _F) (@150 mA, T _s = 25°C)	V	-	GB	6.0	6.5	7.0
Luminous Flux ²⁾ (Φ _v) (@150 mA, T _s = 25°C)	lm	2700K	S0	94.0	106.0	118.0
		3000K	S0	96.0	108.0	120.0
		3500K	S0	99.0	111.0	123.0
		4000K	S0	101.0	113.0	125.0
		5000K	S0	107.0	119.0	131.0
		5700K	S0	103.0	115.0	127.0
		6500K	S0	101.0	113.0	125.0
Reverse Voltage (@5 mA, T _s = 25°C)	V	-	-	0.7	-	1.2
Color Rendering Index ³⁾ (R _a)	-	-	5	80	-	-
Special CRI ⁴⁾ (R9)	-	-	-	0	-	-
Thermal resistance (Junction to solder point)	°C/W	-	-	-	11	-

Notes:

1)~4) SAMSUNG ELECTRONICS maintains a tolerance of V_F:±0.1 V, Φ_v:±5 %, R_a :±3.0, R9 :±6.5 on measurements

3. Typical Characteristics Graph

1) Spectrum Distribution ($I_F = 150\text{mA}$, $T_s = 25^\circ\text{C}$)

(1) CCT : 2700K

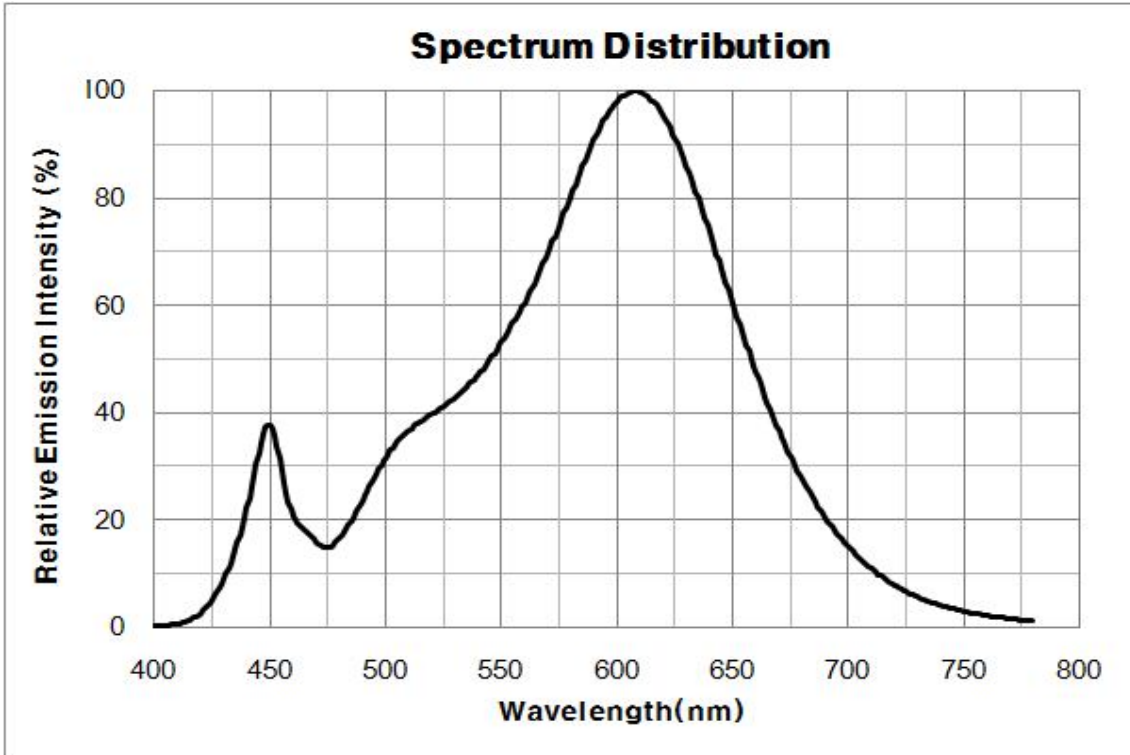

(2) CCT : 3000K

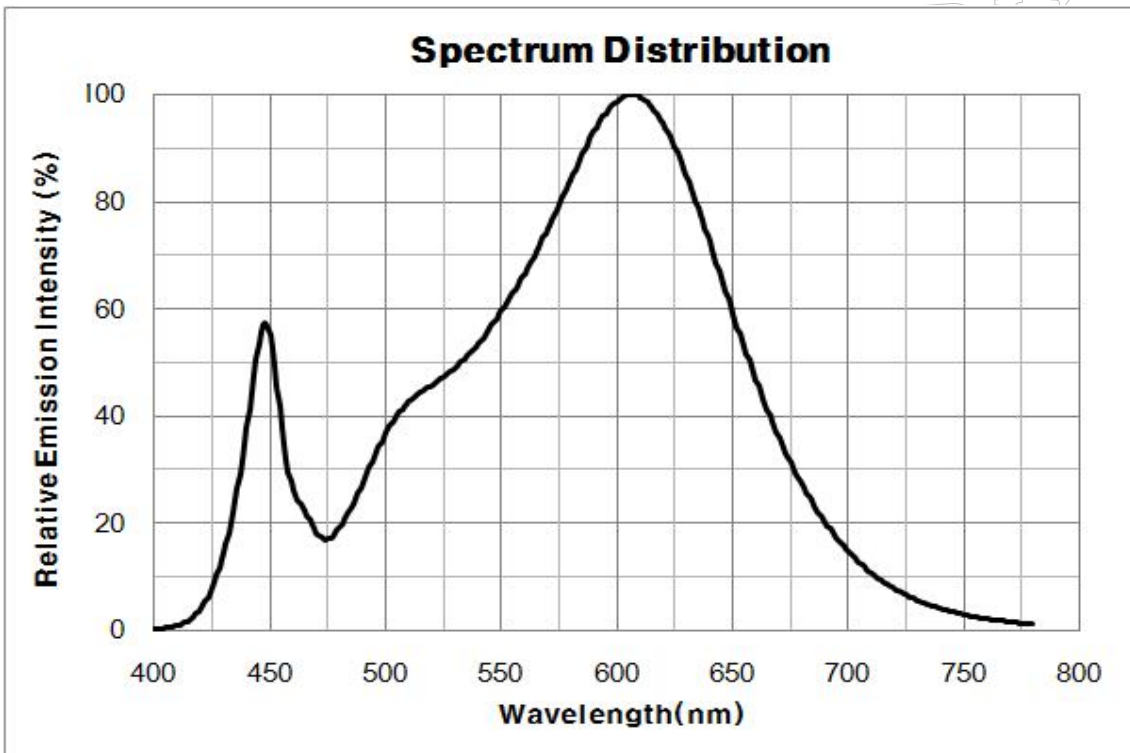

(3) CCT : 3500K

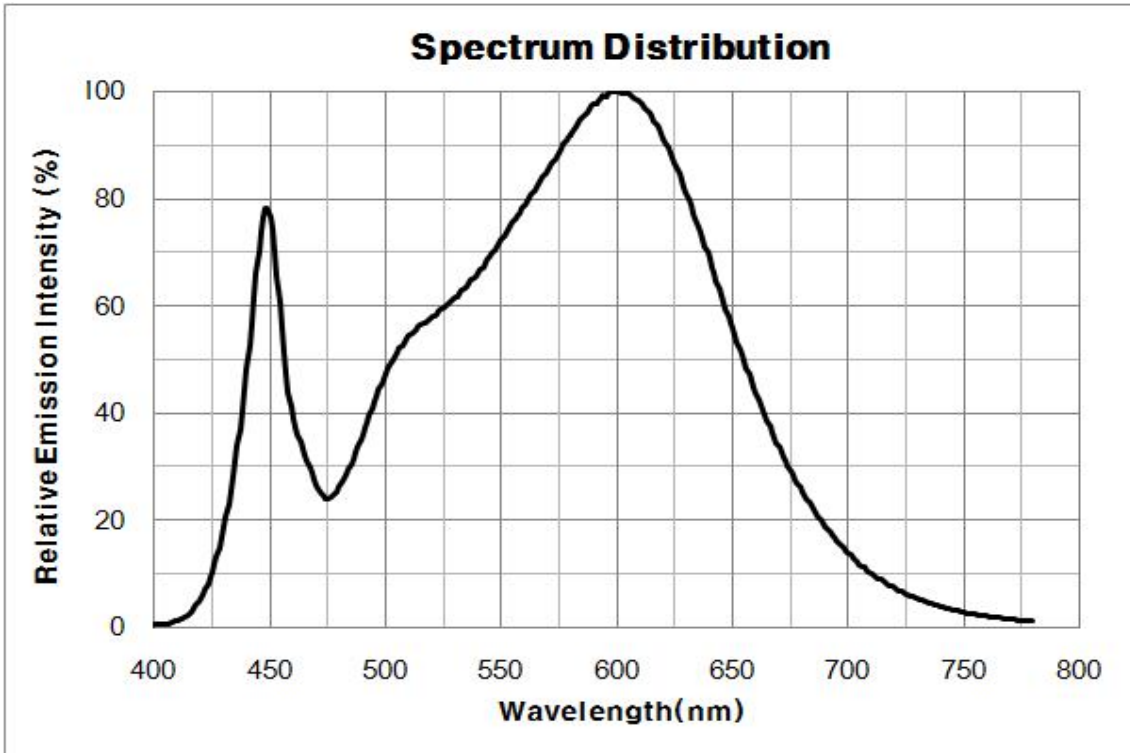

(4) CCT : 4000K

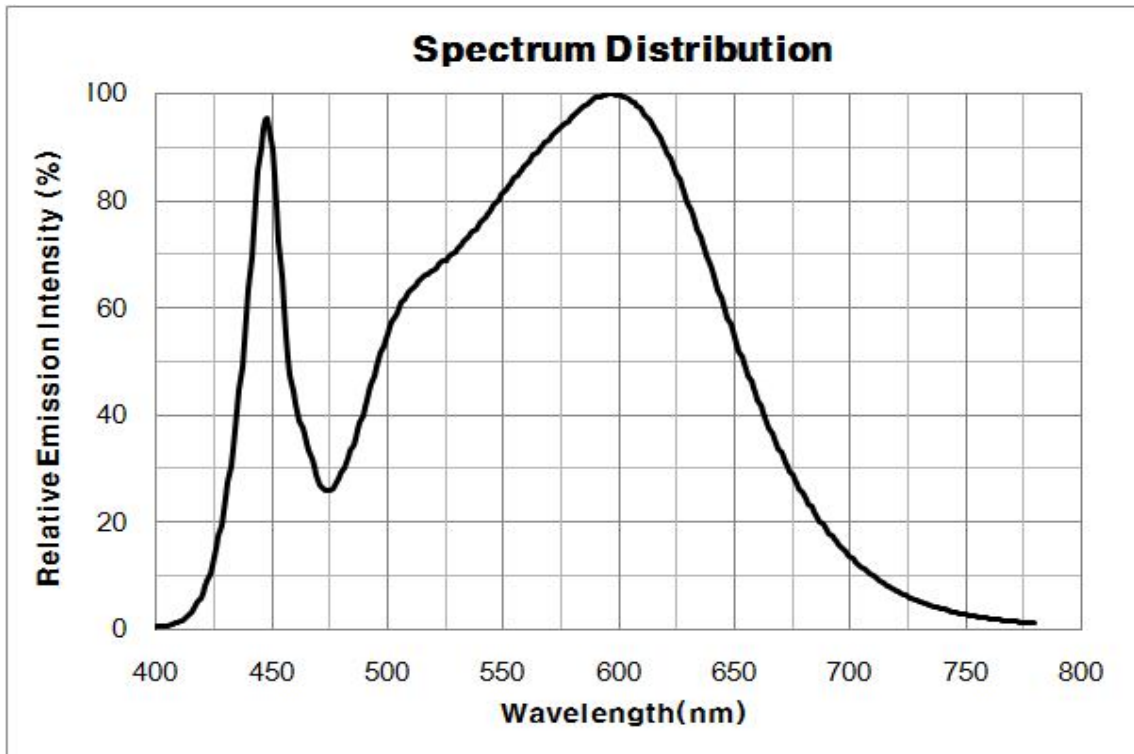

(5) CCT : 5000K

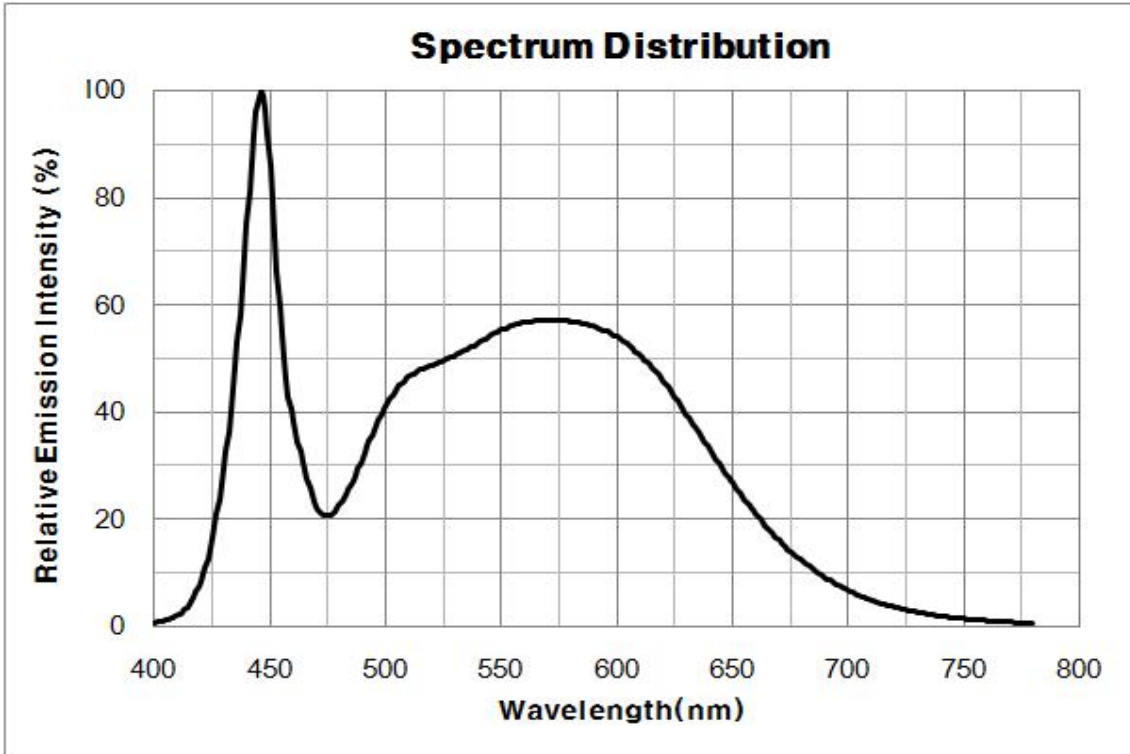

(6) CCT : 5700K

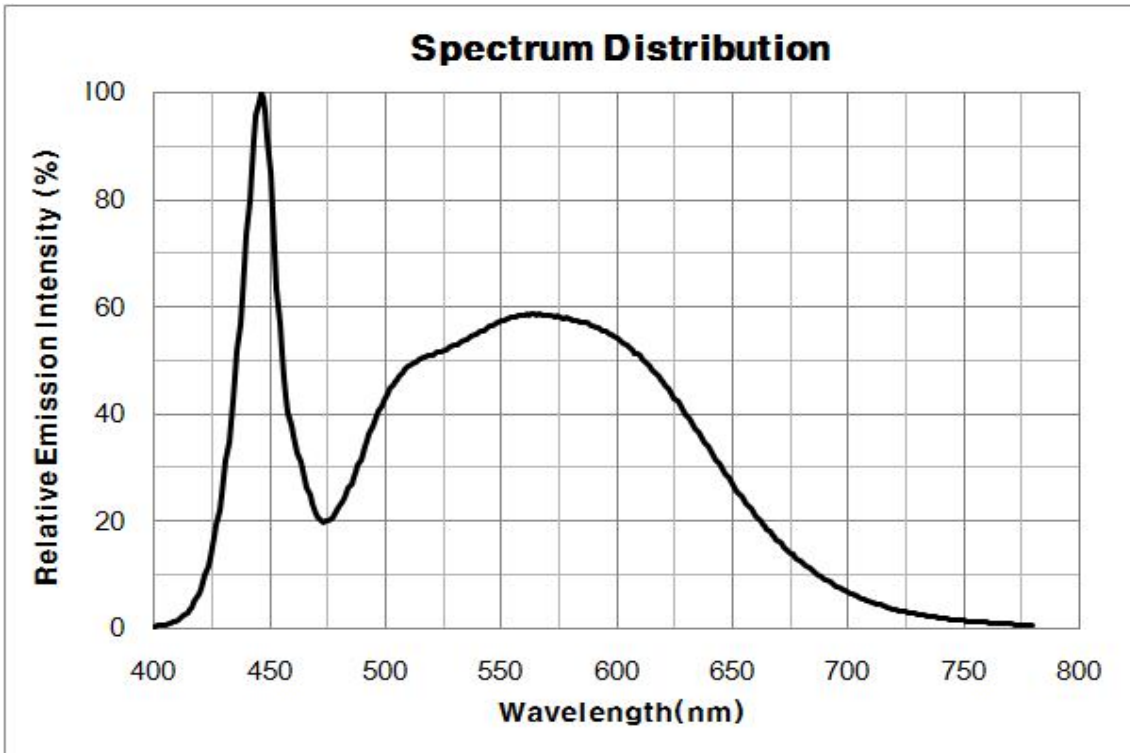

(4) CCT :6500K

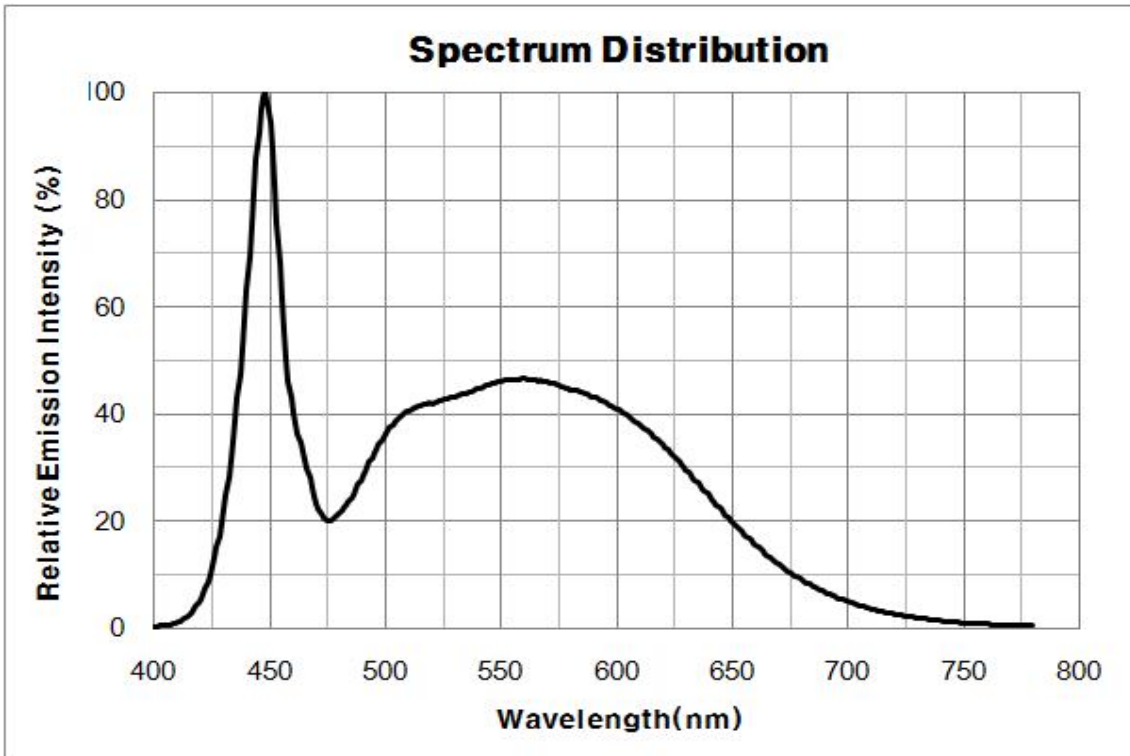

PRELIMINARY

2) Forward Current Characteristics ($T_s = 25^\circ\text{C}$)

(1) Relative Luminous Flux vs. Forward Current

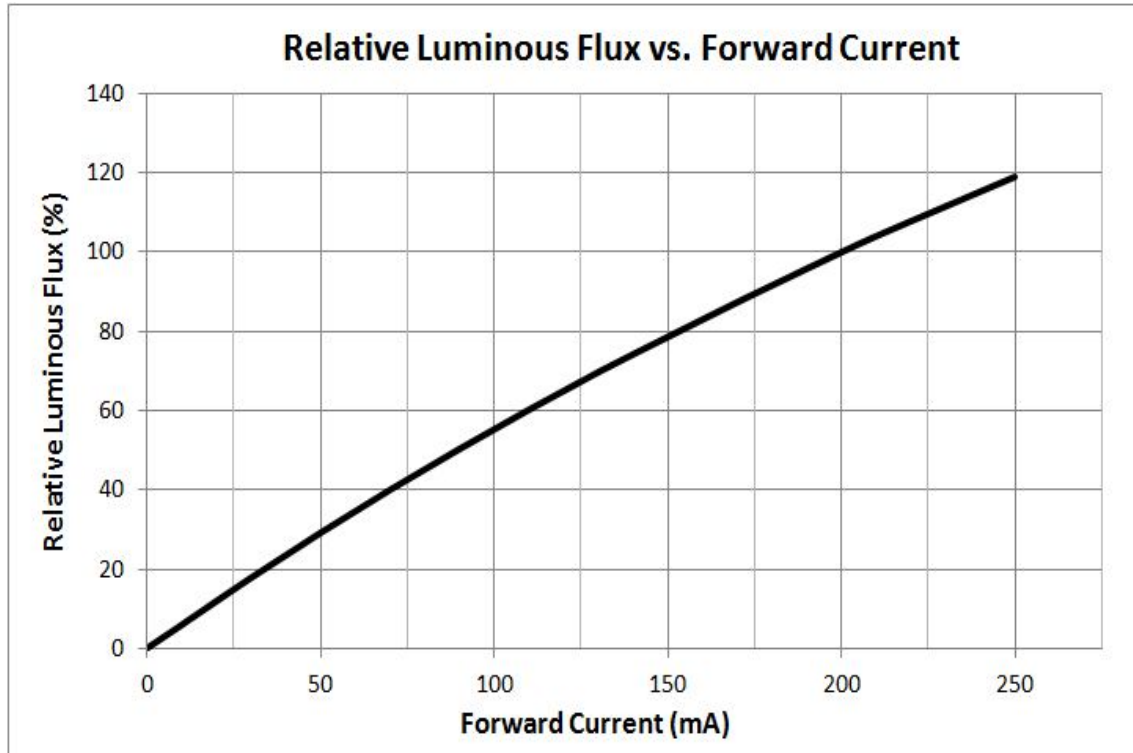

(2) Relative Forward Voltage vs. Forward Current

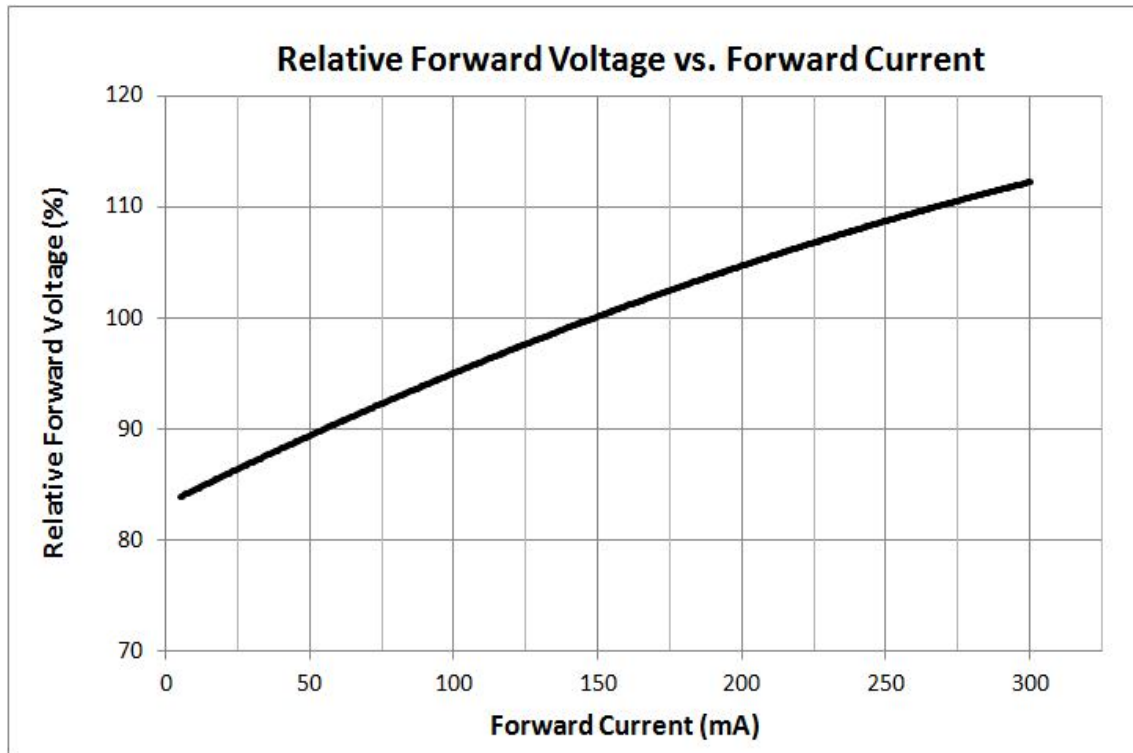

3) Temperature Characteristics ($I_F = 150\text{mA}$)
(1) Relative Luminous Flux vs. T_s

T.B.D

(2) Relative Forward Voltage vs. T_s

T.B.D



4-1) Color Shift Characteristics ($T_s = 25^\circ\text{C}$)

(1) $\Delta\text{CIE X}$ & $\Delta\text{CIE Y}$ vs. Forward Current

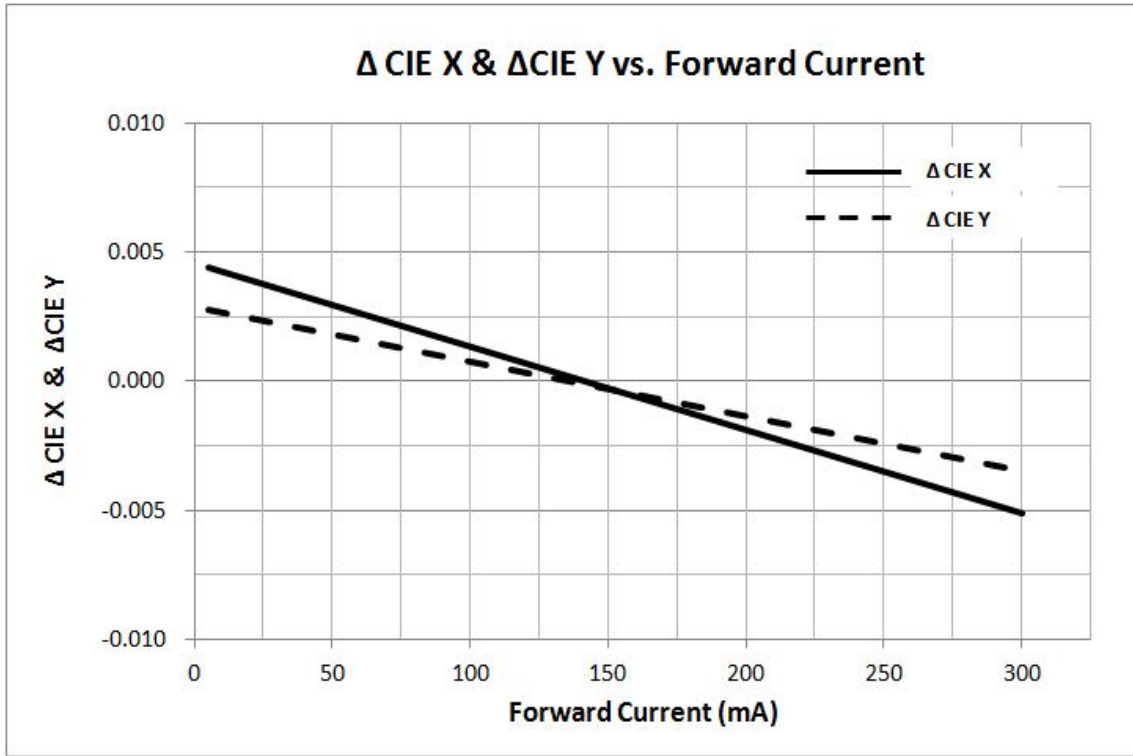

PRELIMINARY

4-2) Color Shift Characteristics ($I_F = 150\text{mA}$)

(1) $\Delta\text{CIE X}$ & $\Delta\text{CIE Y}$ vs. T_s

T.B.D

(2) CIE X & CIE Y vs. T_s

T.B.D



5) Derating Curve

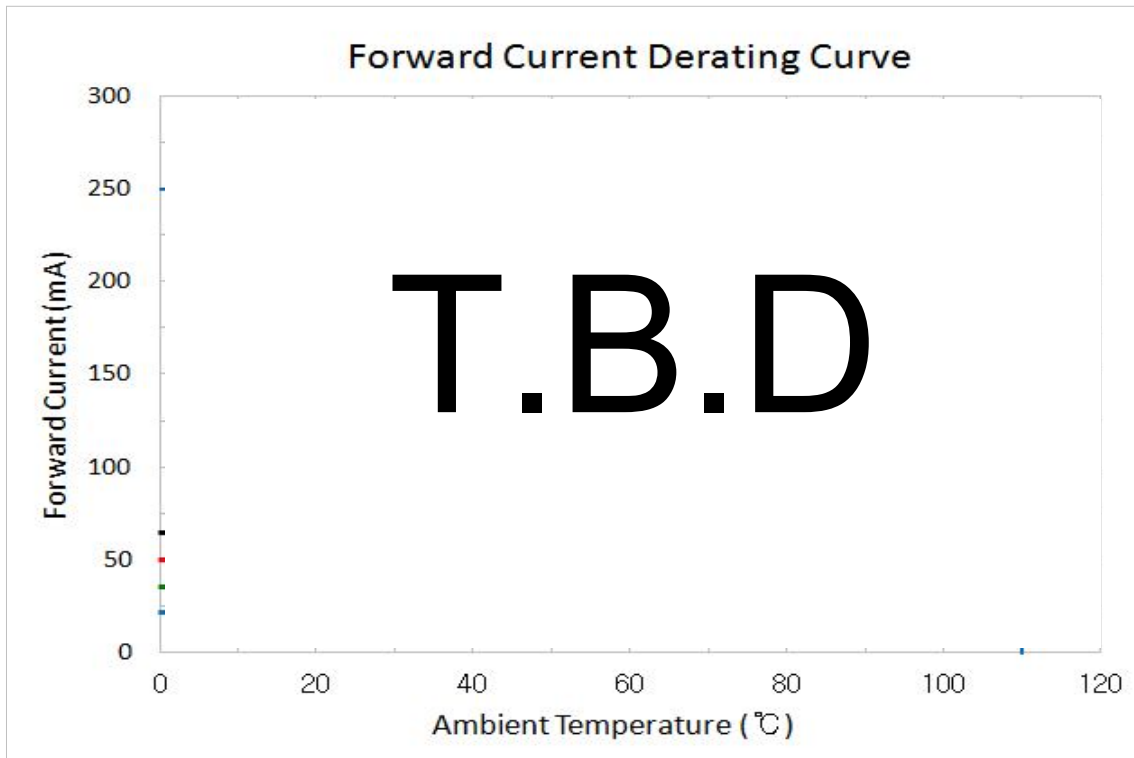

6) Beam Angle Characteristics ($I_F = 150\text{mA}$, $T_s = 25^\circ\text{C}$)

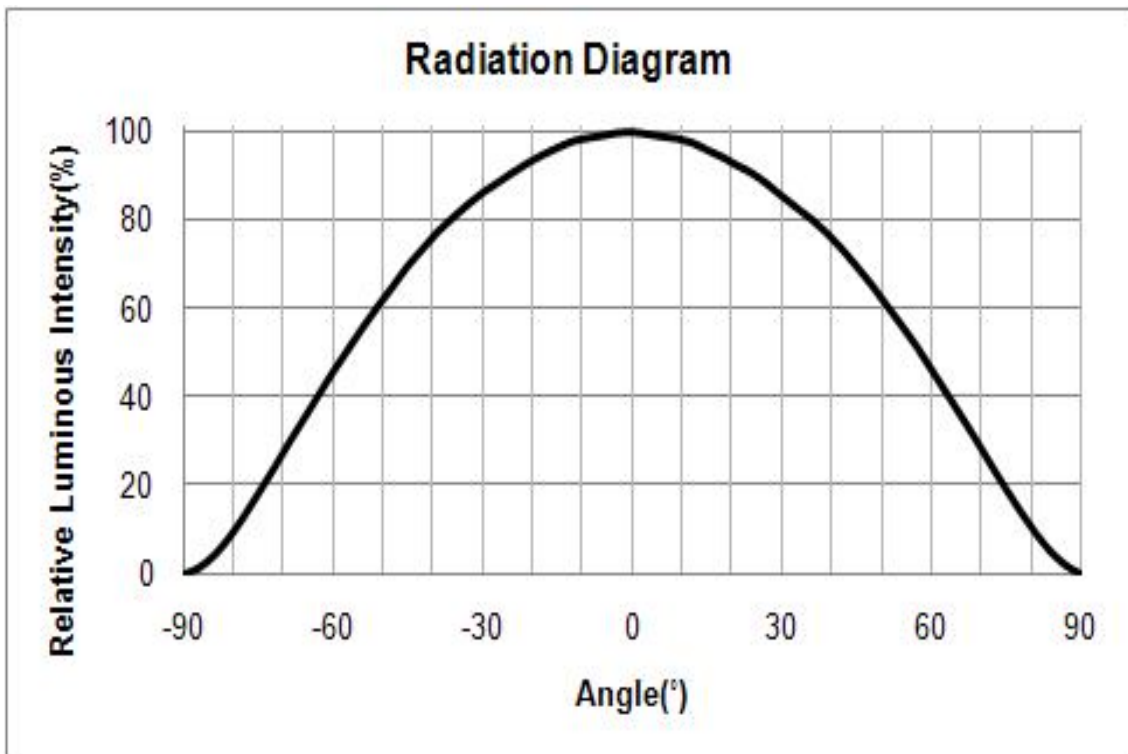

4. Outline Drawing & Dimension

Left Side View

Top View

Bottom View

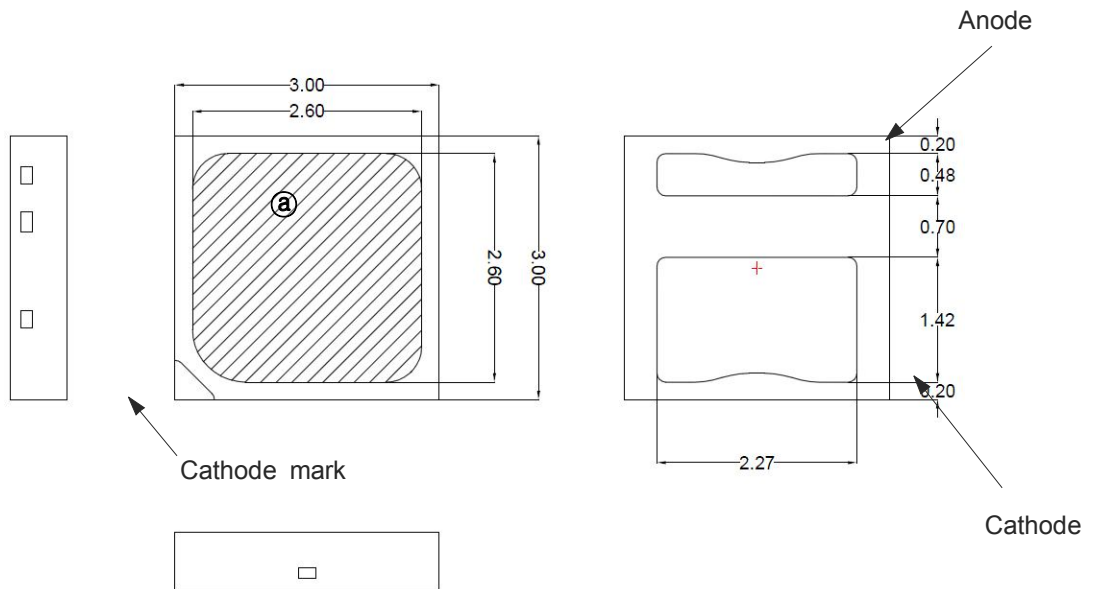

1. Tolerance is ± 0.1 mm

2. Do not place pressure on the encapsulation resin (a)

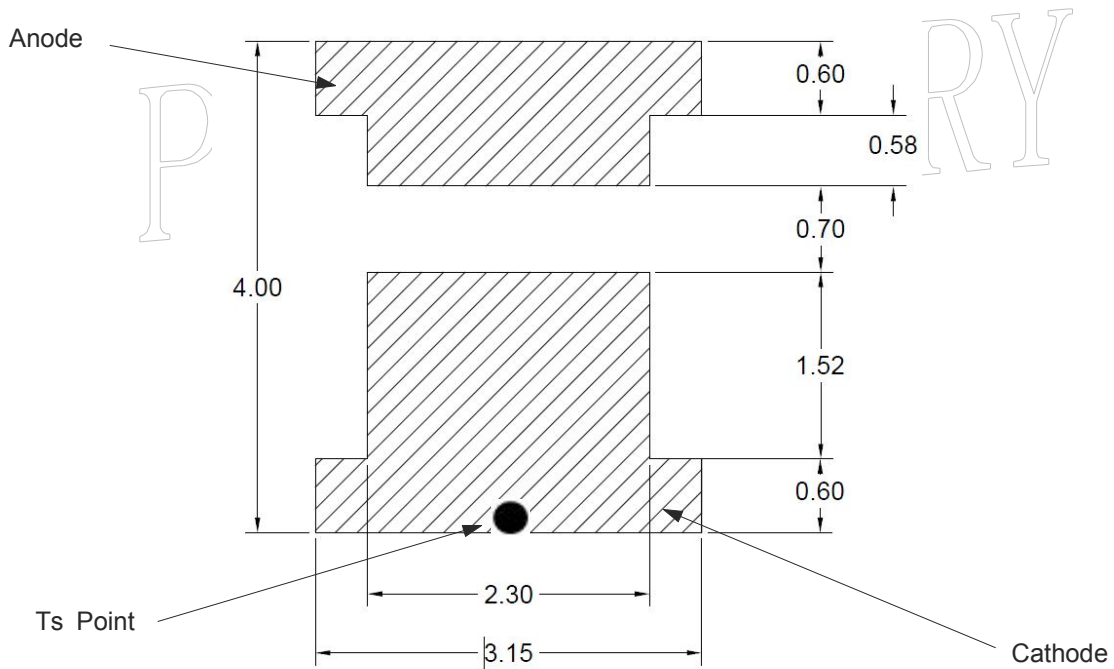

Recommended Land Pattern



Notes:

- 1) This LED has built-in ESD protection device(s) connected in parallel to LED Chip(s).
- 2) Ts point & measurement method
 - ① Measure the nearest point to the thermal pad. If necessary, remove PSR of PCB to reach Ts point.
 - ② Thermal pad must be soldered to the PCB to dissipate heat properly. Otherwise, LED can be damaged.
- 3) The thermal pad is electrically connected to the cathode contact pads
- 4) Precautions
 - ① The pressure on the LEDs will influence to the reliability of the LEDs. Precautions should be taken to avoid the strong pressure on the LEDs. Do not put stress on the LEDs during heating.
 - ② Re-soldering should not be done after the LEDs have been soldered. If re-soldering is unavoidable, LED's characteristics should be carefully checked before and after such repair.
 - ③ Do not stack assembled PCBs together. Since materials of LEDs is soft, abrasion between two PCB assembled with LED might cause catastrophic failure of the LEDs.

PRELIMINARY

5. Reliability Test Items & Conditions

1) Test Items and Results

Test Item	Test Conditions	Test Hours/Cycles	Sample Size	
Room Temperature Life Test	25°C±3°C, DC 200mA	1,000 hrs	22	
High Temperature Life Test	85°C±3°C, DC 200mA	1,000 hrs	22	
High Temperature Humidity Life Test	85°C±3°C, 85%±2%RH, DC 200mA	1,000 hrs	22	
Low Temperature Life Test	-40°C±3°C, DC 200mA	1,000 hrs	22	
Powered Temperature Cycle Test	-45°C/20min ↔ 85°C/20min, Sweep 100min cycle on/off: each 5min, DC 200mA	100 cycles	22	
Thermal Shock	-45°C/15min ↔ 125°C/15min, → Hot plate 180°C	500 cycles	100	
High Temperature Storage	Ta=120°C±3°C	1,000 hrs	11	
Low Temperature Storage	Ta=-40°C±3°C	1,000 hrs	11	
ESD(HBM)		R1 : 10MΩ, R2 : 1.5KΩ, C : 100pF, V = ±5kV	5 times	30
ESD(MM)		R1 : 10MΩ, R2 : 0, C : 200pF, V = ±0.5kV	5 times	30
Vibration Test	20~2000~20 Hz 200 m/s ² , Sweep 4 min X, Y, Z 3 direction, each 1 cycle	4 cycles	11	
Mechanical Shock Test	1500G, 0.5ms, 3 shocks each X-Y-Z axis	5 cycles	11	

2) Criteria for Judging the Damage

Item	Symbol	Test Condition	Limit	
			Min	Max
Forward Voltage	V _F	I _F = 150 mA	Init. Value*0.9	Init. Value*1.1
Luminous Flux	Φ _v	I _F = 150 mA	Init. Value*0.7	Init. Value*1.1

6. Solder Conditions

1) Reflow Conditions (Pb Free)

Reflow Frequency : 2 times max.

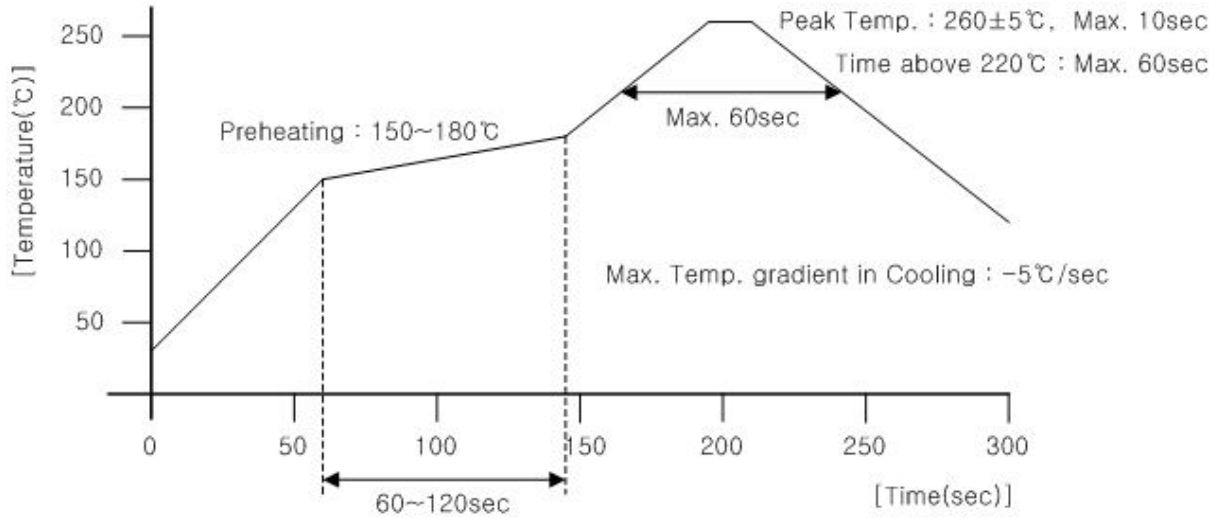

2) For Manual Soldering

Not more than 5 seconds @Max. 300°C, under soldering iron.

PRELIMINARY

7. Tape & Reel

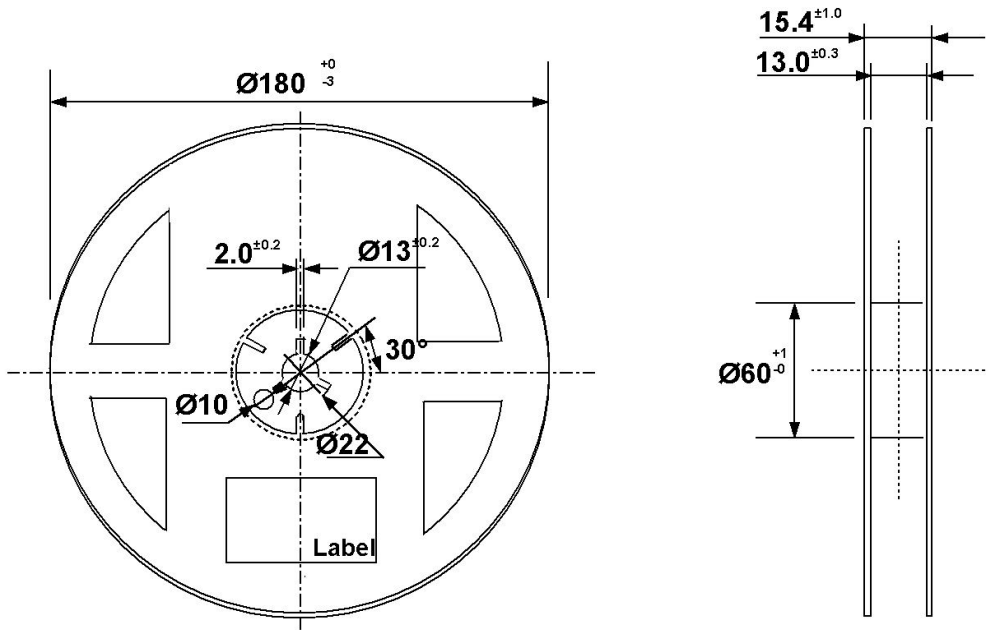
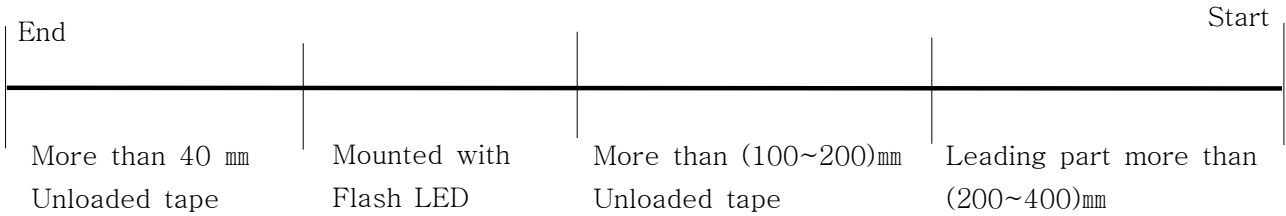
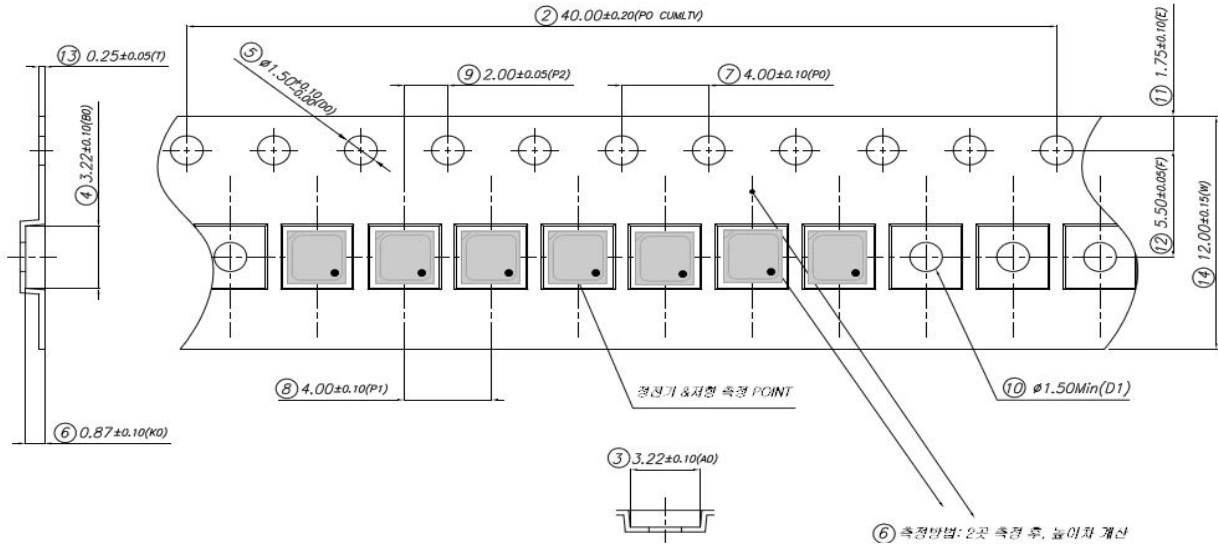

Tolerance ± 0.2 , Unit:mm

- (1) Quantity : The quantity/reel to be 4,000 pcs.
- (2) Cumulative Tolerance : Cumulative tolerance/10 pitches to be ± 0.2 mm
- (3) Adhesion Strength of Cover Tape : Adhesion strength to be 0.1-0.7 N when the cover tape is turned off from the carrier tape at 10 °C angle to be the carrier tape.
- (4) Packaging : P/N, Manufacturing data code no. and quantity to be indicated on a damp proof package.

8. Label Structure

1) Label Structure

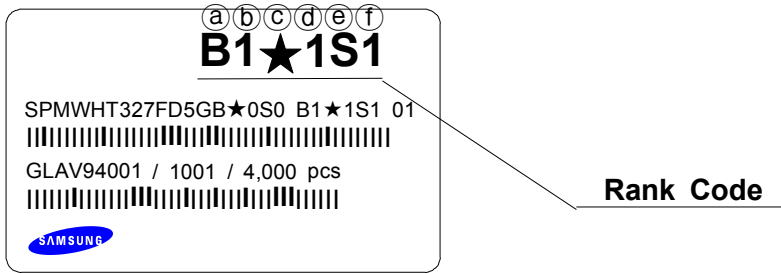

N.B) Denoted rank is the only example.

'★' means All kind of Chromaticity Coordinate Rank.

Rank Code

- ⒶⒷ : Forward Voltage(V_F) Rank (refer to page. 12)
- ⒸⒹ : Chromaticity Coordinate Rank (refer to page. 7~9)
- ⒺⒻ : Luminous Intensity(cd) Rank (refer to page. 3 and 4)

2) LOT Number

The Lot number is composed of the following characters

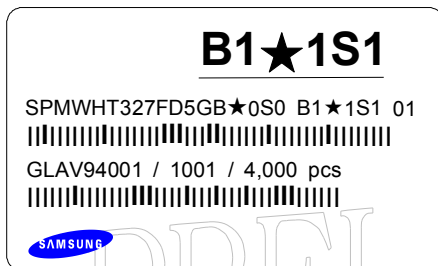

①②③④⑤⑥⑦⑧⑨ / 1ⒶⒷⒸ / 4,000 PCS

- ① : Production Site (S:SAMSUNG ELECTRONICS, G:TIANJIN CHINA)
- ② : L (LED)
- ③ : Product State (A:Normality, B:Bulk, C:First Production, R:Reproduction, S:Sample)
- ④ : Year (Y:2014, Z:2015...)
- ⑤ : Month (1 ~ 9, A, B, C)
- ⑥ : Day (1 ~ 9, A, B ~ V)
- ⑦⑧⑨ : SAMSUNG ELECTRONICS LED Product number (1 ~ 999)
- ⒶⒷⒸ : Reel Number (1 ~ 999)



9. Packing Structure

1) Packing Process

Reel

B1★1S1
 SPMWHT327FD5GB★0S0 B1★1S1 01
 GLAV94001 / 1001 / 4,000 pcs

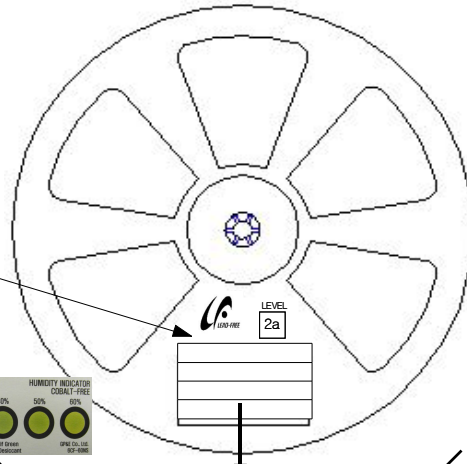

Aluminum Vinyl Bag

B1★1S1
 SPMWHT327FD5GB★0S0 B1★1S1 01
 GLAV94001 / 1001 / 4,000 pcs

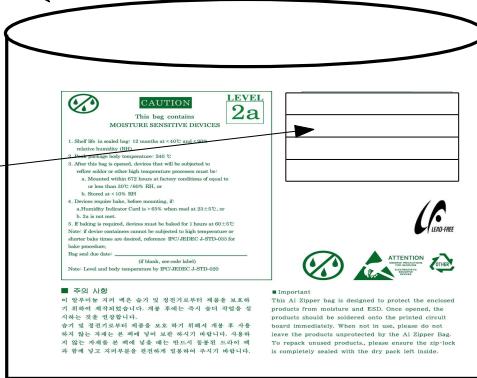

Material : Paper(SW3B(B))

TYPE	SIZE(mm)			Note
	L	W	H	
7inch L	245±5	220±5	182±5	Up to 10 Reels
7inch S	245±5	220±5	86±5	Up to 5 Reels

① SIDE

B1★1S1
 SPMWHT327FD5GB★0S0 B1★1S1 01
 GLAV94001 / 1001 / 40,000 pcs

[Box Label]

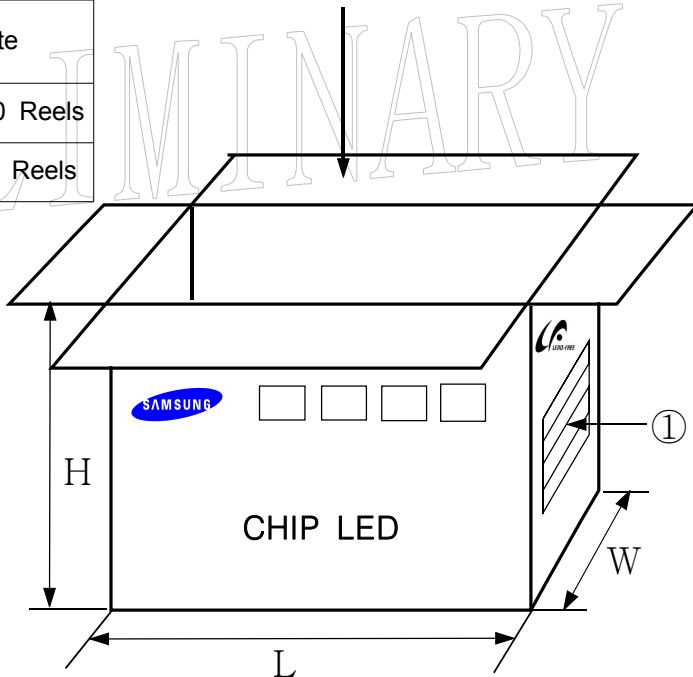

2) Aluminum Packing Bag

CAUTION

This bag contains
MOISTURE SENSITIVE DEVICES

LEVEL

2a

1. Shelf life in sealed bag: 12 months at <math>< 40^{\circ}\text{C}</math> and <math>< 90\%</math> relative humidity (RH)
2. Peak package body temperature: 240 °C
3. After this bag is opened, devices that will be subjected to reflow solder or other high temperature processes must be:
 - a. Mounted within 672 hours at factory conditions of equal to or less than 30°C / 60% RH, or
 - b. Stored at <math>< 10\%</math> RH
4. Devices require bake, before mounting, if:
 - a. Humidity Indicator Card is > 65% when read at 23±5°C, or
 - b. 2a is not met.
5. If baking is required, devices must be baked for 1 hours at 60±5°C

Note: if device containers cannot be subjected to high temperature or shorter bake times are desired, reference IPC/JEDEC J-STD-033 for bake procedure,

Bag seal due date: _____
(if blank, see code label)

Note: Level and body temperature by IPC/JEDEC J-STD-020

B1★1S1

SPMWHT327FD5GB★0S0 B1★1S1 01

|||||

GLAV94001 / 1001 / 4,000 pcs

|||||



주의 사항

이 알루미늄 지퍼 백은 습기 및 정전기로부터 제품을 보호하기 위하여 제작되었습니다. 개봉 후에는 즉시 솔더 작업을 실시하는 것을 권장합니다.

습기 및 정전기로부터 제품을 보호 하기 위해서 개봉 후 사용하지 않는 자재는 본 팩에 넣어 보관 하시기 바랍니다. 사용하지 않는 자재를 본 팩에 넣을 때는 반드시 동봉된 드라이 팩과 함께 넣고 지퍼부분을 완전하게 밀봉하여 주시기 바랍니다.

Important

This Al Zipper bag is designed to protect the enclosed products from moisture and ESD. Once opened, the products should be soldered onto the printed circuit board immediately. When not in use, please do not leave the products unprotected by the Al Zipper Bag. To repack unused products., please ensure the zip-lock is completely sealed with the dry pack left inside.

Silica gel & Humidity Indicator Card in Aluminum Vinyl Bag

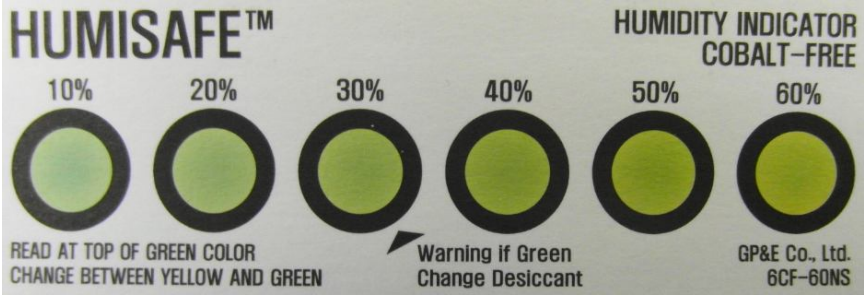

10. Precaution for use

- 1) For over-current-proof function, customers are recommended to apply resistors to prevent sudden change of the current caused by slight shift of the voltage.
- 2) This device should not be used in any type of fluid such as water, oil, organic solvent, etc. When washing is required, IPA is recommended to use.
- 3) When the LEDs illuminate, operating current should be decided after considering the ambient maximum temperature.
- 4) LEDs must be stored in a clean environment.
If the LEDs are to be stored for 3 months or more after being shipped from Samsung Electronics, they should be packed by a sealed container with nitrogen gas injected.(Shelf life of sealed bags: 12 months, temp. $\sim 40^{\circ}\text{C}$, $\sim 90\%RH$)
- 5) After storage bag is open, device subjected to soldering, solder reflow, or other high temperature processes must be:
 - a. Mounted within 672 hours(28 days) at an assembly line with a condition of no more than $30^{\circ}\text{C}/60\%RH$,
 - b. Stored at $<10\%RH$.
- 6) Repack unused Products with anti-moisture packing, fold to close any opening and then store in a dry place.
- 7) Devices require baking before mounting, if humidity card reading is $>60\%$ at $23\pm 5^{\circ}\text{C}$.
- 8) Devices must be baked for 1 hour at $65\pm 5^{\circ}\text{C}$, if baking is required.
- 9) The LEDs are sensitive to the static electricity and surge. It is recommended to use a wrist band or anti-electrostatic glove when handling the LEDs.
If voltage exceeding the absolute maximum rating is applied to LEDs, it may cause damage or even destruction to LED devices.
Damaged LEDs may show some unusual characteristics such as increase in leak current, lowered turn-on voltage, or abnormal lighting of LEDs at low current.

10) VOCs (volatile organic compounds) can be generated from adhesives, flux, hardener or organic additives used in luminaires (fixtures). Transparent LED silicone encapsulant is permeable to those chemicals and they may lead a discoloration of encapsulant when they expose to heat or light.

This phenomenon can cause a significant loss of light emitted(output) from the luminaires(fixture).

In order to prevent these problems, we recommend you to know the physical properties of materials used in luminaires, They must be selected carefully.

11) Risk of Sulfurization (or Tarnishing)

The LED from Samsung Electronics uses a silver-plated lead frame and its surface color may change to black(or dark colored) when it is exposed to sulfur (S), chlorine (Cl) or other halogen compound

Sulfurization of the lead frame may cause intensity degradation, change of chromaticity coordinates and, in extreme cases. open circuit. It requires caution.

Due to possible sulfurization of lead frame, LED should not be used and stored together with oxidizing substances made of materials in a following list,

: Rubber, Plain paper, lead solder cream and so on.

PRELIMINARY

X-ON Electronics

Largest Supplier of Electrical and Electronic Components

Click to view similar products for [High Power LEDs - White category:](#)

Click to view products by [Samsung manufacturer:](#)

Other Similar products are found below :

[G42180-08](#) [B42180-08](#) [STW8Q2PA-R5-HA](#) [SZ5-M1-W0-00-V3/W2-AA](#) [LTPL-P00DWS57](#) [LZP-D0WW00-0000](#) [CLM-9-30-90-36-AC32-F4-3](#) [SZ5-M1-WW-C8-V1/V3-FA](#) [BXRC-27E2000-D-73](#) [BXRC-27G2000-D-73](#) [BXRC-30E1000-D-73](#) [BXRC-30G2000-D-73](#) [BXRC-40E1000-D-73](#) [BXRE-30G2000-B-73](#) [BXRE-30G2000-C-73](#) [BXRE-50C2001-C-74](#) [CXM-22-27-80-54-AC30-F4-3](#) [XHP50B-00-0000-0D0UH245G](#) [XHP50B-00-0000-0D0UH240G](#) [XHP50B-00-0000-0D0UG227H](#) [XHP50B-00-0000-0D0HJ245G](#) [MP-5050-8100-27-80](#) [MP-5050-6100-65-80](#) [MP-5050-6100-50-80](#) [MP-5050-6100-40-80](#) [MP-5050-6100-30-80](#) [CXM-22-30-80-54-AC30-F4-3](#) [LTW-2835SZK57](#) [BXEM-50C0000-0-000](#) [WW-WNA30TS-U1\(M1\)](#) [KW CSLPM2.CC-8L8M-4L8N](#) [KW CSLPM2.CC-8L8M-4O9Q](#) [KW DPLS32.SB-6H6J-E5P7-EG-Z264](#) [L1V1-507003V500000](#) [CXM-22-35-80-36-AC10-F3-3](#) [KW3 CGLNM1.TG-Z6QF6-EBVFFCBB46-DFGA](#) [JB5630AWT-H-H65EA0000-NZ000001](#) [XHP50B-00-0000-0D0UG430H](#) [CXM-22-35-90-54-AC40-F5-3](#) [CXM-22-35-80-54-AC40-F5-3](#) [OSM51206E1N-0.8T](#) [OSW43020C1C](#) [MP161611032290](#) [MP-1616-2103-50-90](#) [KW CULPM1.TG-Z6RF7-ebvFfcbB46-65G5](#) [KW DMLS33.SG-Z6M7-EBVFFCBB46-8E8G-700-S](#) [XPGDWT-B1-0000-00EEA](#) [XHP70B-00-0000-0D0BP450E](#) [KW DMLN33.SG-7J7K-EBVFFCBB46-8E8G-200-S](#) [ASMT-MW05-NMNS1](#)