

RoHS
Ready 



SOLARLOK Interconnection System

OBSOLETE
NOT the LATEST
REVISION

 Tyco Electronics

 Table of Contents

| | |
|---|----|
| The SOLARLOK Concept | 1 |
| Large Junction Box – Serial Interconnection | 2 |
| Large Junction Box – Parallel Interconnection | 3 |
| Medium Junction Box – Serial Interconnection | 4 |
| Small Junction Box – Serial Interconnection | 6 |
| Mini Junction Box – Serial Interconnection | 8 |
| Cable Coupler | 9 |
| T-Branch Connector | 10 |
| DC/AC Converter Receptacle | 11 |
| AC Inverter Connector | 12 |
| Solar Cable | 13 |
| Solar Cable, 1-Pole | 14 |
| Field Wiring, Switching and Protection | 15 |
| Wiring Example with Extension Cable | 16 |
| SolKlip™ – Ground Clip | 18 |
| Interconnection Examples | 20 |
| Application Tooling | 22 |
| Assembly and Installation Guidelines | 24 |
| Technical Data | 29 |
| Numerical Index | 30 |
| Restriction on the Use of Hazardous Substances (RoHS) | 31 |
| Engineering Notes | 32 |

Product Information Center (PIC)

Our PIC team are there to help with any further questions.

With our experienced employees in the Product Information Center (PIC) we can offer you a reliable source of information and support for your technical queries.

To contact your local Tyco Electronics subsidiary, please refer to the address page at the back of this catalog.

Product und Machine Literature

Order quickly and easily by fax:

For Fax No. see address page entry for your specific region.

A large product range has extensive product literature. You can request flyers, catalogs and brochures for each of the product sectors of relevance to you.

Tyco Electronics Online

Internet Homepage:
www.tycoelectronics.com

Electronic Internet Catalog:
<http://catalog.tycoelectronics.com>



Our website is more than an Internet guide. It is constantly being added to and is an innovative and interactive source for applications tips, product updates and technical information of all types. With our innovative StepSearch software, which has been perfected over a period of several years you can conveniently surf your way through all our products.

The SOLARLOK Concept

System Features

Junction Box

- Variable wiring options
- Easily accessible
- Simple, fast and cost-effective assembly
- Flat, low profile design
- High current carrying capacity
- Good thermal balance
- Connectorized or direct wire configurations
- Up to four outputs possible
- Up to six internal rails
- Customer-specific solutions
- TÜV and UL approved

Connector

- Simple on-site processing
- Mating safety provided by keyed housings
- Semi-automatic assembly capability possible
- Multiple plugging and unplugging cycles
- Accommodates solar cable with different insulation diameters
- High current carrying capacity
- Wide temperature operating range
- TÜV and UL approved

Solar Cable

- Dual wall insulation
- Electron beam cross-linked
- Excellent resistance to U.V., water, ozone, fluids, salt, general weathering
- Excellent resistance to abrasion
- Halogen free, flame retardant, low toxicity
- Very low smoke emissions
- Excellent flexibility and stripping performance
- Different cable diameters
- Operating Temperature from -40 °C up to +120 °C
- Voltage Rating up to 2600 V DC
- IEC 60228 Class 5 (stranded tin plated copper and flexible)
- TÜV certified acc. to 2Pfg 1169/08.2007
- UL certified



Simple and Reliable System Interconnection of Individual Solar Modules Right to the DC/AC Converters

Market expansion of the formerly regulated energy supply sector, increased global environmental awareness and governments committing themselves to more stringent environmental targets have opened up new opportunities for the photovoltaic industry.

Having served a niche market in the past, the photovoltaics industry now has the opportunity to move into mass production, realizing economies of scale and gaining a greater market share of the world's energy mix.

Tyco Electronics will be contributing to the establishment of this environmentally-friendly technology with the introduction of its SOLARLOK connector system.

SOLARLOK delivers a flexible system solution for easy and reliable interconnections from photovoltaic modules to the DC/AC converter. The entire system concept is based on cost-effective and reliable processing of individual interconnection system components. This significantly reduces installation costs of the solar energy system.

The junction box concept is based on a flexible, open system structure, which allows serial as well as parallel interconnection via direct wire connect or separable connectors. Within the junction box, up to six termination places rails are available for photovoltaic foil connection.

The male and female cable coupler was designed for high voltage and high current-carrying capacity in addition to the well-established IP 67 sealing requirement in the photovoltaic industry. Mating safety is provided by polarity keyed housings, fully shrouded contacts, reliable high cycle life, and squeeze to release connection system. In addition, a wide temperature range and fulfillment of worldwide standards for photovoltaic connection systems complement the robust product specification.

The design of the male and female receptacle for the junction box and the DC/AC converter follow the cable coupler "click philosophy" for quick and secure mating even in difficult mounting positions.

If required by the customer, the junction box can be delivered pre-configured with diodes, jumpers, plug connectors, and solar cable pigtails.

Large Junction Box – Serial Interconnection

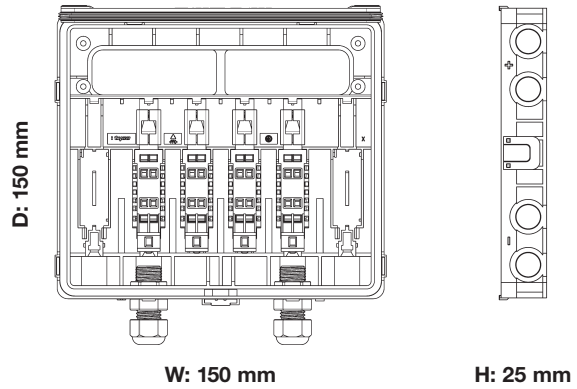

| SERIAL INTERCONNECTION | | | | | | | |
|------------------------|-------------|------------------|-------------------------|-------------|-------------|---------------|--------|
| Configuration | Part Number | Package Quantity | Interconnection Options | | | Contact Rails | Diodes |
| | | | Plug Connector | | Direct Wire | | |
| | | | Plus Keyed | Minus Keyed | | | |
| | 1-1394723-6 | 20 | | | □□ | □□□□□ | |
| | 2-1394723-6 | 20 | | | □□ | □□□□□ | □□□□ |
| | 1394723-4 | 20 | | | □□ | □□□□□ | |
| | 1394723-3 | 20 | □ | □ | | □□□□□ | |

Large Junction Box – Parallel Interconnection

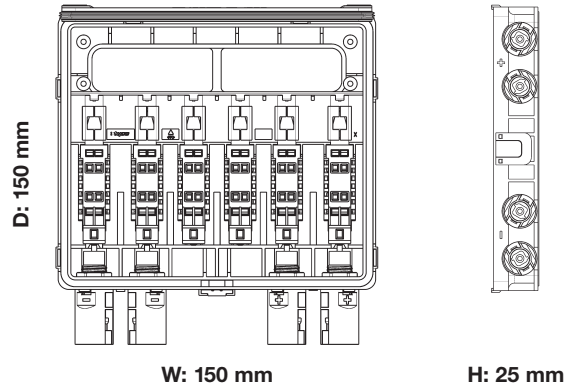

| PARALLEL INTERCONNECTION | | | | | | | |
|--------------------------|-------------|------------------|-------------------------|-------------|-------------|---------------|--------|
| Configuration | Part Number | Package Quantity | Interconnection Options | | | Contact Rails | Diodes |
| | | | Plug Connector | | Direct Wire | | |
| | | | Plus Keyed | Minus Keyed | | | |
| | 1394723-5 | 20 | □ | □ | | □□□□□□ | |
| | 1394723-6 | 20 | | | □□□□ | □□□□□□ | |
| | 1394723-9 | 20 | | | □□□□ | □□□□ | |

Medium Junction Box – Serial Interconnection

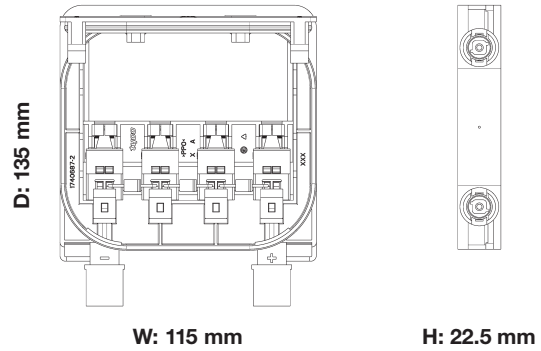

| SERIAL INTERCONNECTION | | | | | | | |
|------------------------|-------------|------------------|-------------------------|-------------|-------------|---------------|---------------|
| Configuration | Part Number | Package Quantity | Interconnection Options | | | Contact Rails | Diodes |
| | | | Plug Connector | | Direct Wire | | |
| | | | Plus Keyed | Minus Keyed | | | |
| | 1740699-1 | 60 | | | □□ | □□□□ | □□□ SL1010 |
| | 1740699-6* | 35 | | | □□ | □□□□ | □□□ SL1010 |
| | 1740700-1 | 60 | □ | □ | | □□□□ | □□□ SL1010 |
| | 1740700-3** | 35 | □ | □ | | □□□□ | □□□ SL1010 |
| | 1740971-1 | 60 | | | □□ | □□□□ | □□□ SL1515 |
| | 1740971-2* | 35 | | | □□ | □□□□ | □□□ SL1515 |
| | 1740972-1 | 60 | □ | □ | | □□□□ | □□□ SL1515 |
| | 1740972-3** | 35 | □ | □ | | □□□□ | □□□ SL1515 |

*) Junction Box Assembly with two 100 cm long 4.0 mm² black solar cable and plug connector.
 **) Junction Box Assembly with one 200 cm long 4.0 mm² black solar cable and two plug connectors.

Medium Junction Box – Serial Interconnection (continued)

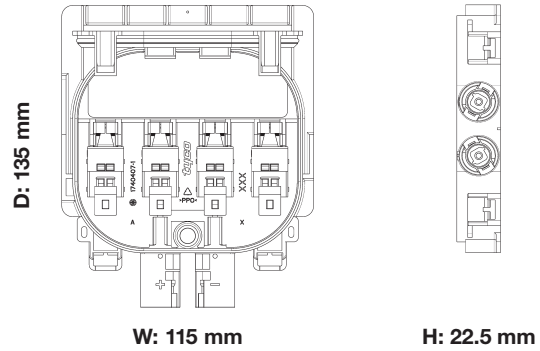

SERIAL INTERCONNECTION

| Configuration | Part Number | Package Quantity | Interconnection Options | | | Contact Rails | Diodes |
|---------------|--------------|------------------|-------------------------|-------------|-------------|---------------|-----------------------------|
| | | | Plug Connector | | Direct Wire | | |
| | | | Plus Keyed | Minus Keyed | | | |
| | 1740657-7 | 60 | | | □□ | □□□□ | □□ SL1010 □ SL1515 |
| | 1740657-8* | 35 | | | □□ | □□□□ | □□ SL1010 □ SL1515 |
| | 1740658-1 | 60 | □ | □ | | □□□□ | □□ SL1010 □ SL1515 |
| | 1740658-3** | 35 | □ | □ | | □□□□ | □□ SL1010 □ SL1515 |
| | 1740657-9 | 60 | | | □□ | □□□□ | □□□ SL1515 |
| | 1-1740657-0* | 35 | | | □□ | □□□□ | □□□ SL1515 |
| | 1740658-4 | 60 | □ | □ | | □□□□ | □□□ SL1515 |
| | 1740658-5** | 35 | □ | □ | | □□□□ | □□□ SL1515 |

*) Junction Box Assembly with two 100 cm long 4.0 mm² black solar cable and plug connector.
 **) Junction Box Assembly with one 200 cm long 4.0 mm² black solar cable and two plug connectors.

Small Junction Box – Serial Interconnection

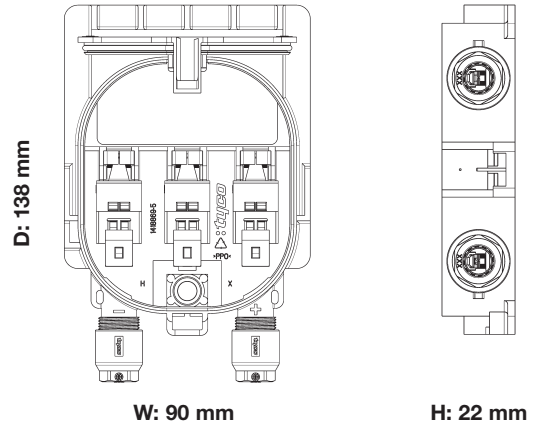

| SERIAL INTERCONNECTION | | | | | | | |
|------------------------|-------------|------------------|-------------------------|-------------|-------------|---------------|--------|
| Configuration | Part Number | Package Quantity | Interconnection Options | | | Contact Rails | Diodes |
| | | | Plug Connector | | Direct Wire | | |
| | | | Plus Keyed | Minus Keyed | | | |
| | 1740220-4 | 80 | | | □□ | □□ | |
| | 1740220-2 | 80 | | | □□ | □□ | □ |
| | 1740425-3* | 48 | | | □□ | □□ | □ |
| | 1740220-3 | 80 | | | □□ | □□□ | |
| | 1740220-1 | 80 | | | □□ | □□□ | □□ |
| | 1740425-1** | 48 | | | □□ | □□□ | □□ |

*) Junction Box Assembly with two 70 cm long 4.0 mm² black solar cable and plug connector.
 **) Junction Box Assembly with two 85 cm long 4.0 mm² black solar cable and plug connectors.

Small Junction Box – Serial Interconnection (continued)

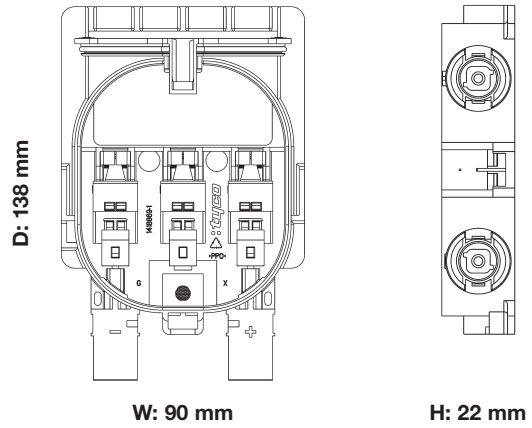

| SERIAL INTERCONNECTION | | | | | | | |
|------------------------|---------------|------------------|--------------------------|--------------------------|-------------|---------------|--------|
| Configuration | Part Number | Package Quantity | Interconnection Options | | | Contact Rails | Diodes |
| | | | Plug Connector | | Direct Wire | | |
| | | | Plus Keyed | Minus Keyed | | | |
| | 1418867-2 | 80 | <input type="checkbox"/> | <input type="checkbox"/> | | □□ | |
| | 1418867-5 | 80 | <input type="checkbox"/> | <input type="checkbox"/> | | □□ | □ |
| | 1-1418867-3* | 48 | <input type="checkbox"/> | <input type="checkbox"/> | | □□ | □ |
| | 1418867-1 | 80 | <input type="checkbox"/> | <input type="checkbox"/> | | □□□ | |
| | 1418867-6 | 80 | <input type="checkbox"/> | <input type="checkbox"/> | | □□□ | □□ |
| | 1-1418867-2** | 48 | <input type="checkbox"/> | <input type="checkbox"/> | | □□□ | □□ |

*) Junction Box Assembly with one 140 cm long 4.0 mm² black solar cable and two plug connectors.
 **) Junction Box Assembly with one 170 cm long 4.0 mm² black solar cable and two plug connectors.

Mini Junction Box – Serial Interconnection

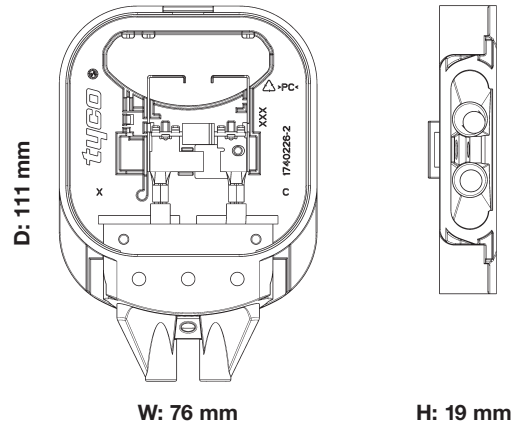



SERIAL INTERCONNECTION

| Configuration | Part Number | Package Quantity | Contact Rail Shape | Direct Wire | Contact Rails | Diodes |
|---------------|-------------|------------------|--------------------|-------------|---------------|--------|
| | 1740863-1* | 80 | Straight | □□ | □□ | □ |
| | 1740863-2* | 80 | Right-Angle | □□ | □□ | □ |



*) Junction Box Assembly with two 85 cm long 4.0 mm² black solar cable and plug connector.

Cable Coupler



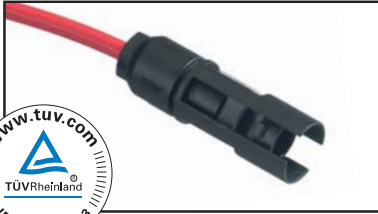

| Wire Size (mm ²) | Female Cable Coupler | | Male Cable Coupler | | Package Quantity |
|------------------------------|----------------------|-------------|--------------------|-------------|------------------|
| | Plus Keyed | Minus Keyed | Plus Keyed | Minus Keyed | |
| 2.5 | 1394462-1 | 1394462-2 | 1394461-1 | 1394461-2 | 100 |
| 4.0 | 1394462-3 | 1394462-4 | 1394461-3 | 1394461-4 | 100 |
| 6.0 | 5-1394462-5 | 5-1394462-6 | 6-1394461-5 | 6-1394461-6 | 100 |

Male Cable Coupler Not Keyed, only for Junction Box Serial Interconnection

| Wire Size (mm ²) | Male Cable Coupler | Package Quantity |
|------------------------------|--------------------|------------------|
| 2.5 | 6-1394461-1 | 100 |
| 4.0 | 6-1394461-2 | 100 |
| 6.0 | 6-1394461-4 | 100 |



Cable Coupler with Connector Latch Locking Clip

| Connector Latch Locking Clip | Package Quantity |
|------------------------------|------------------|
| 1534226-1 | 100 |

T-Branch Connector

Parallel Interconnection using T-Branch Connector (Male-to-Male)



| T-Branch Connector | | Part Number | Package Quantity |
|--------------------|-------------|-------------|------------------|
| Plus Keyed | Minus Keyed | | |
| □ | | 1534611-1 | 20 |
| | □ | 1534611-2 | 20 |

Parallel Interconnection using T-Branch Connector (Female-to-Male)



| T-Branch Connector | | Part Number | Package Quantity |
|--------------------|-------------|-------------|------------------|
| Plus Keyed | Minus Keyed | | |
| □ | | 1740277-1 | 20 |
| | □ | 1740277-2 | 20 |

DC/AC Converter Receptacle



O-Ring and Metal Nut



Flat Seal and Plastic Nut



With Cover

| Wire Size | | Keying | | Part Number | Package Quantity | Remarks |
|---------------------------------|---------------------------------|--------------------------|--------------------------|-------------|------------------|----------------------|
| 2.5 mm ² (AWG 14) | 4.0 mm ² (AWG 12) | Plus | Minus | | | |
| <input type="checkbox"/> | | <input type="checkbox"/> | | 1394738-1 | 100 | O-Ring and Metal Nut |
| <input type="checkbox"/> | | | <input type="checkbox"/> | 1394738-2 | 100 | |
| | <input type="checkbox"/> | <input type="checkbox"/> | | 1394738-3 | 100 | |
| | <input type="checkbox"/> | | <input type="checkbox"/> | 1394738-4 | 100 | |

| | | | | | | |
|--------------------------|--------------------------|--------------------------|--------------------------|-------------|-----|-----------------------------------|
| <input type="checkbox"/> | | <input type="checkbox"/> | | 1740210-1 | 100 | Flat Seal and Plastic Nut – Black |
| <input type="checkbox"/> | | | <input type="checkbox"/> | 1740210-2 | 100 | |
| | <input type="checkbox"/> | <input type="checkbox"/> | | 1740210-3 | 100 | |
| | <input type="checkbox"/> | | <input type="checkbox"/> | 1740210-4 | 100 | |
| <input type="checkbox"/> | | <input type="checkbox"/> | | 1740210-7 | 100 | Flat Seal and Plastic Nut – Red |
| <input type="checkbox"/> | | | <input type="checkbox"/> | 1740210-8 | 100 | Flat Seal and Plastic Nut – Blue |
| | <input type="checkbox"/> | <input type="checkbox"/> | | 1740210-9 | 100 | Flat Seal and Plastic Nut – Red |
| | <input type="checkbox"/> | | <input type="checkbox"/> | 1-1740210-0 | 100 | Flat Seal and Plastic Nut – Blue |





| | | | | | | |
|--------------------------|--------------------------|--------------------------|--------------------------|-----------|-----|-------|
| <input type="checkbox"/> | <input type="checkbox"/> | <input type="checkbox"/> | <input type="checkbox"/> | 1394739-1 | 100 | Cover |
|--------------------------|--------------------------|--------------------------|--------------------------|-----------|-----|-------|

AC Inverter Connector

Product Facts

- **Current Rating:**
30 A
- **Voltage Rating:**
400 V
- **Protection Degree:**
IP67 (mated)
- **No. of Positions:**
5 Poles
- **Temperature Range:**
-40 °C up to +50 °C
- **Wire Size Range:**
2.5–6.0 mm²
- **Approvals:**
 - VDE certified
 - UL pending



| Configuration | 5 Pole | Cable Length 200 mm (5 x 4 mm ²) | Metall Nut | Plastic Nut | Part Number | Package Quantity |
|---|--------------------------|--|--------------------------|--------------------------|-------------|---------------------|
|  | <input type="checkbox"/> | <input type="checkbox"/> | <input type="checkbox"/> | | 1740483-1 | 24 |
|  | <input type="checkbox"/> | <input type="checkbox"/> | | <input type="checkbox"/> | 1740483-2 | 24 |
|  | <input type="checkbox"/> | | | | 1740479-1 | 24 |
|  | <input type="checkbox"/> | <input type="checkbox"/> | <input type="checkbox"/> | | 1740493-1 | 24 |
|  | <input type="checkbox"/> | <input type="checkbox"/> | | <input type="checkbox"/> | 1740493-2 | 24 |

Solar Cable

Product Facts

- Dual wall insulation
- Electron beam cross-linked
- Excellent resistance to UV, water, ozone, fluids, salt, general weathering
- Excellent resistance to abrasion
- Halogen free, flame retardant, low toxicity
- Very low smoke emissions
- Excellent flexibility and stripping performance
- Wire size from 2.5 mm² up to 6.0 mm²

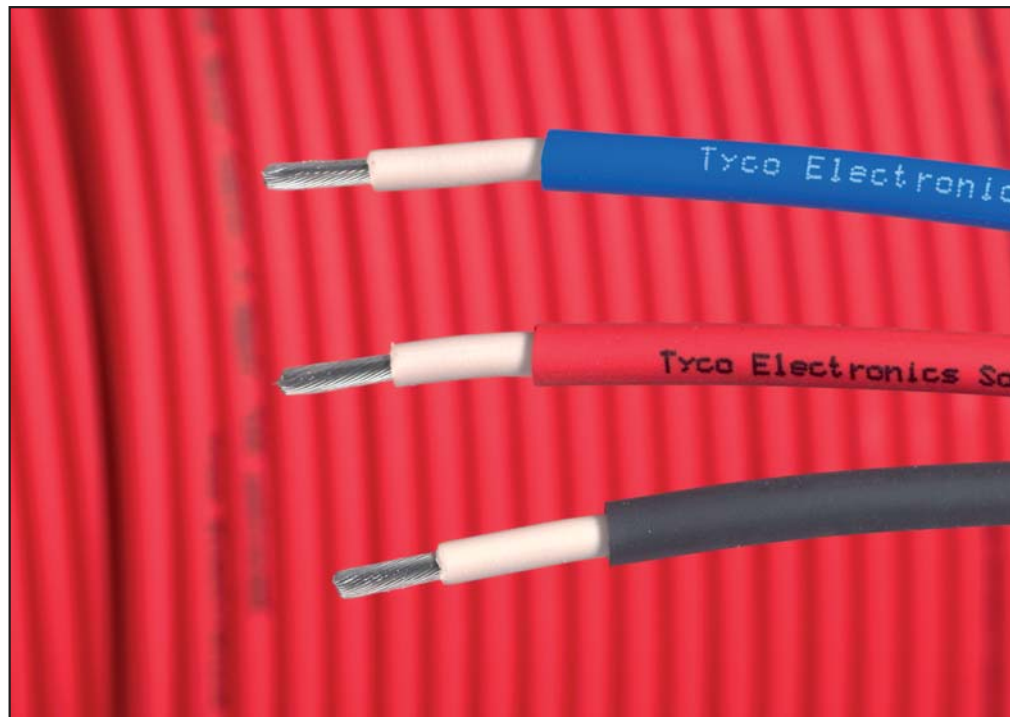

As part of expanding the SOLARLOK Product Line, Tyco Electronics has specified a wire that is designed to meet the harsh environmental conditions typical in the wiring of photovoltaic installations.

The flexible, dual wall, halogen free and cross linked solar wire offers long term stability and TÜV approval.

Its outstanding features include: high resistance against environmental conditions like humidity, UV-radiation and ozone.

In addition, it has excellent resistance to abrasion and temperature extremes.

The wire has a high dielectric withstand voltage and with its fine-stranded, tin plated copper conductor, it is easy to handle and to strip.

Standards

Approval:

- IEC 60228 Class 5 (stranded tin plated copper and flexible);
- TÜV certified acc. to 2Pfg 1169/08.2007



Material and Finish

Conductor:

Stranded tin plated copper

Insulation:

Electron beam cross-linked Polyolefin

Sheath:

Electron beam cross-linked halogen free Polyolefin

Color:

Black, blue, red

Mechanical Features

Max. Conductor Temperature

Continuous: +120 °C

At Short Circuit: +250 °C

Min. Operating Temperature

Free Installation: -25 °C

Fixed Installation: -40 °C

Wire Size Range:

2.5 mm² (AWG 14),

4.0 mm² (AWG 12),

6.0 mm² (AWG 10)

Min. Bending Radius:

5 x cable wire diameter, fixed installation

Electrical Features

Voltage Rating U₀/U:

1800/3000 V AC / 2600 V DC

Test Voltage for 5 Minutes:

6000 V

Max. Current Carrying Capacity (Free in Air):

36 A up to 116 A (size dependent)

Solar Cable, 1-Pole

**Tyco Electronics
Solar Cable, 1-Pole**

- TÜV approved
- UL approved



| Wire Size Range | | Outer Diameter | | Color | Part Number | Package Quantity | | Approbation |
|--------------------|-------|----------------|--------|-------|-------------|------------------|--------|--------------------------|
| (mm ²) | (AWG) | (mm) | (Inch) | | | (m) | (Feet) | TÜV |
| 2.5 | - | 5.1 | 0.20 | Black | 956297-4 | 500 | - | <input type="checkbox"/> |
| | | | | | 1-956297-4 | 100 | - | <input type="checkbox"/> |
| | | | | Red | 956297-5 | 500 | - | <input type="checkbox"/> |
| | | | | | 1-956297-5 | 100 | - | <input type="checkbox"/> |
| | | | | Blue | 956297-6 | 500 | - | <input type="checkbox"/> |
| | | | | | 1-956297-6 | 100 | - | <input type="checkbox"/> |
| 4.0 | - | 5.7 | 0.22 | Black | 956298-4 | 500 | - | <input type="checkbox"/> |
| | | | | | 1-956298-4 | 100 | - | <input type="checkbox"/> |
| | | | | Red | 956298-5 | 500 | - | <input type="checkbox"/> |
| | | | | | 1-956298-5 | 100 | - | <input type="checkbox"/> |
| | | | | Blue | 956298-6 | 500 | - | <input type="checkbox"/> |
| | | | | | 1-956298-6 | 100 | - | <input type="checkbox"/> |
| 6.0 | - | 6.2 | 0.24 | Black | 956299-4 | 500 | - | <input type="checkbox"/> |
| | | | | | 1-956299-4 | 100 | - | <input type="checkbox"/> |
| | | | | Red | 956299-5 | 500 | - | <input type="checkbox"/> |
| | | | | | 1-956299-5 | 100 | - | <input type="checkbox"/> |
| | | | | Blue | 956299-6 | 500 | - | <input type="checkbox"/> |
| | | | | | 1-956299-6 | 100 | - | <input type="checkbox"/> |

| Wire Size Range | | Outer Diameter | | Color | Part Number | Package Quantity | | Approbation |
|--------------------|-------|----------------|--------|-------|-------------|------------------|--------|----------------------------|
| (mm ²) | (AWG) | (mm) | (Inch) | | | (m) | (Feet) | UL |
| - | 14 | - | 0.17 | Black | 1986166-2 | - | 500 | <input type="checkbox"/> * |
| | | | | | 1986166-3 | - | 2500 | <input type="checkbox"/> * |
| - | 12 | - | 0.19 | Black | 1986165-2 | - | 500 | <input type="checkbox"/> * |
| | | | | | 1986165-3 | - | 1500 | <input type="checkbox"/> * |
| - | 10 | - | 0.21 | Black | 1986164-2 | - | 500 | <input type="checkbox"/> * |
| | | | | | 1986164-3 | - | 1000 | <input type="checkbox"/> * |

*) Technical Data upon request.

Field Wiring, Switching and Protection

Product Features

- Modular product concept
- One- /two-pole switches
- Current up to 80 A DC
- Voltage up to 1000 VDC
- Compact, standardized design
- Proven quality

Switching

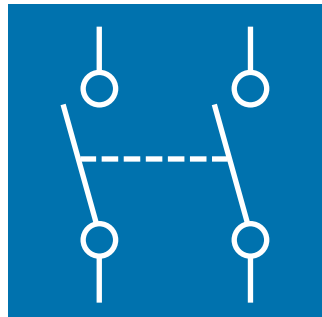

- One- /two-pole switch
- Main switch function
- Lockable
- Current up to 63 A DC
- Voltage up to 900 V U_{oc}

Collecting

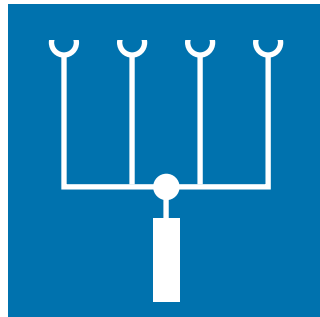

- 1 to 10 strings input
- Cable cross section up to 10 mm²
- SOLARLOK connectors
- Various cable glands
- Current up to 80 A DC
- Voltage up to 1000 V DC

Protecting

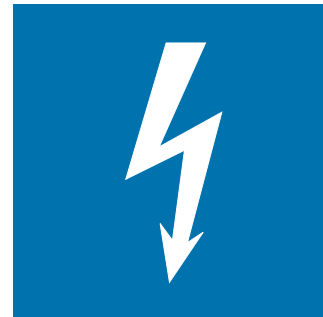

- Lightning protection



Your Solution



The photovoltaic integrator looks for best fit solutions to wire various types and sizes of solar generators.

The new product concept from Tyco Electronics provides this flexibility to photovoltaic integrators.

The modular product can be comprised of a switch, lightning protection, fuses or any combination of these or other commonly available components.

We can customize a product to fit your specific application. Please contact us with your requirements.

Wiring Example with Extension Cables

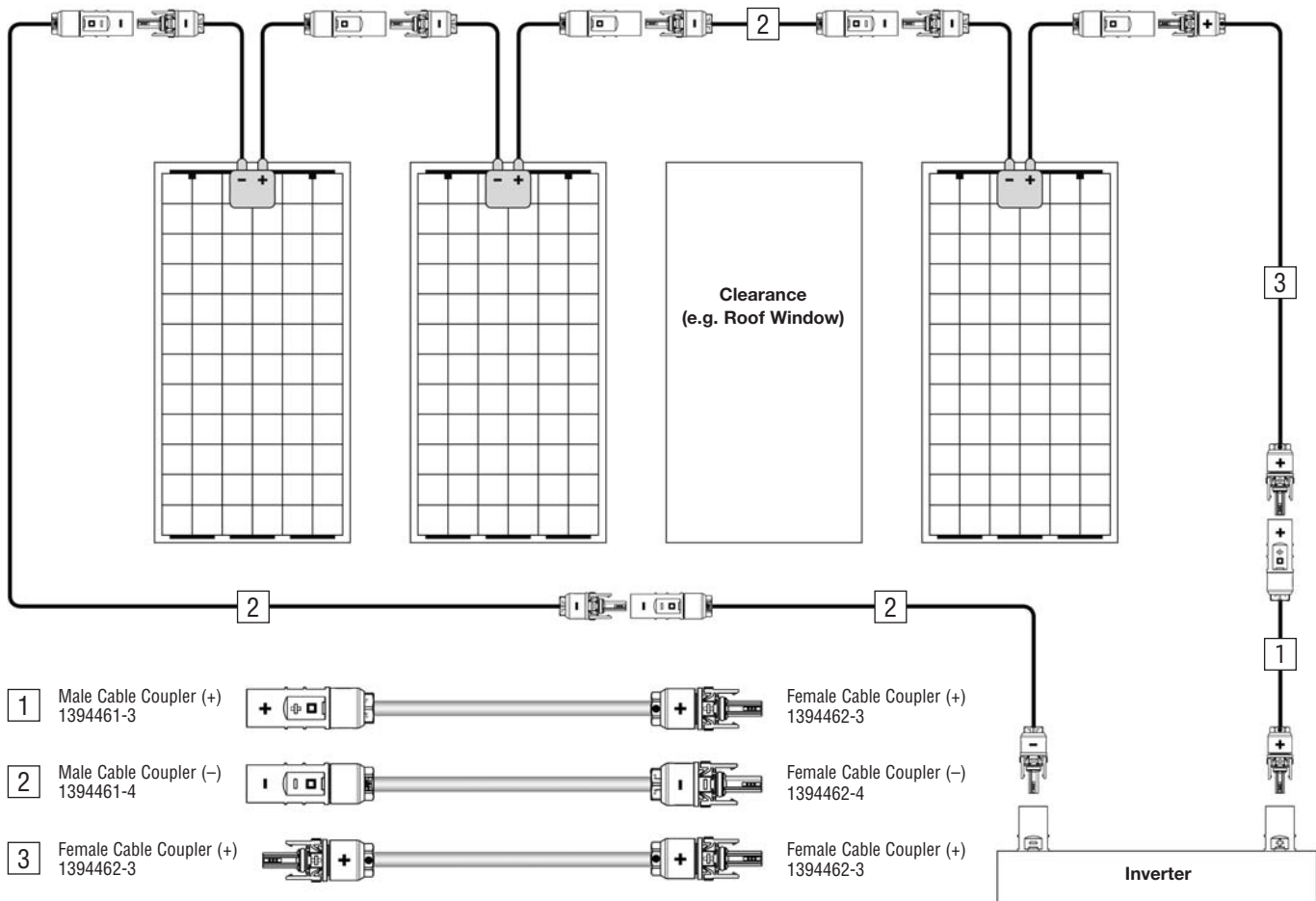

Configuration Example at 4.0 mm².

Cable Assembly

Wire Size:
4.0 mm²

Color:
Black

| Cable Assembly Version | Part Numbers for Cable Length | | | | |
|------------------------|-------------------------------|-------------|-------------|-------------|-------------|
| | 1 m | 3 m | 5 m | 10 m | 20 m |
| 1 | 1987376-1 | 1987376-2 | 1987376-3 | 1987376-4 | 1987376-5 |
| 2 | 1-1987376-1 | 1-1987376-2 | 1-1987376-3 | 1-1987376-4 | 1-1987376-5 |
| 3 | 2-1987376-1 | 2-1987376-2 | 2-1987376-3 | 2-1987376-4 | 2-1987376-5 |

More variants (cable length, wire diameter, color) upon request.

Wiring Example with Extension Cables (continued)

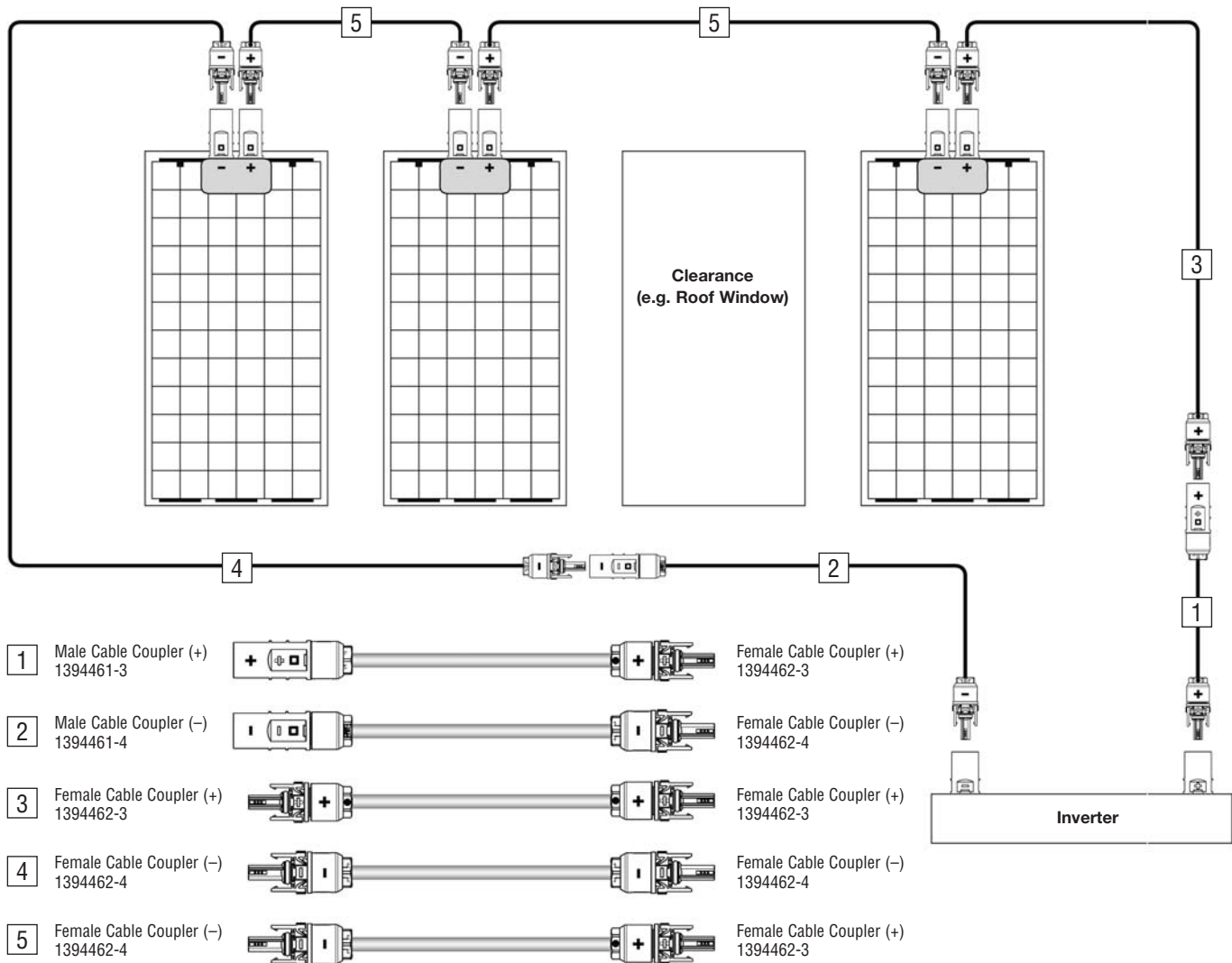

Configuration Example at 4.0 mm².

Cable Assembly

Wire Size:
4.0 mm²

Color:
Black

| Cable Assembly Version | Part Numbers for Cable Length | | | | |
|------------------------|-------------------------------|-------------|-------------|-------------|-------------|
| | 1 m | 3 m | 5 m | 10 m | 20 m |
| 1 | 1987376-1 | 1987376-2 | 1987376-3 | 1987376-4 | 1987376-5 |
| 2 | 1-1987376-1 | 1-1987376-2 | 1-1987376-3 | 1-1987376-4 | 1-1987376-5 |
| 3 | 2-1987376-1 | 2-1987376-2 | 2-1987376-3 | 2-1987376-4 | 2-1987376-5 |
| 4 | 3-1987376-1 | 3-1987376-2 | 3-1987376-3 | 3-1987376-4 | 3-1987376-5 |
| 5 | 4-1987376-1 | 4-1987376-2 | 4-1987376-3 | 4-1987376-4 | 4-1987376-5 |

More variants (cable length, wire diameter, color) upon request.

SolKlip™ – Ground Clip

Product Features

- Self-tapping screw
- Quick and easy mounting
- Four-point contact to wire
- Low interface resistance
- Toolless termination
- Re-terminateable up to 5 times
- UV resistant
- Weather-proof
- UL approved
- RoHS compliant

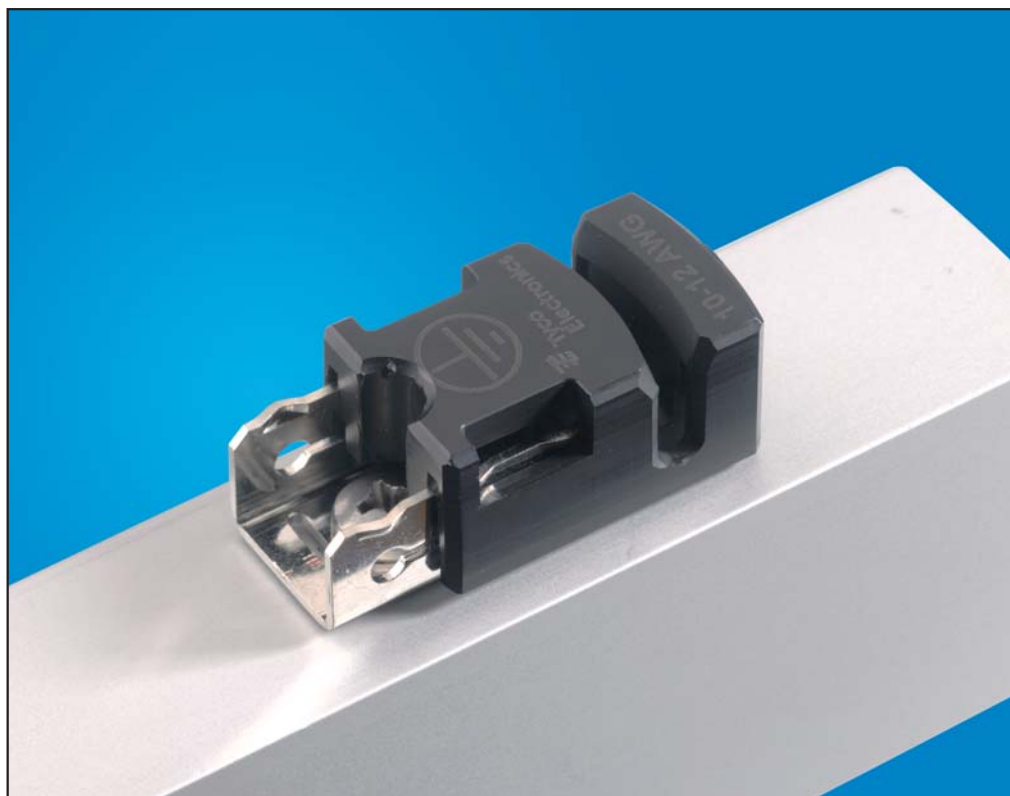

Tyco Electronics' newest innovation provides the photovoltaic integrator with a solution for grounding PV panels and mounting frames. The Tyco Electronics SolKlip brings a new ground connection solution to the market by utilizing well-known insulation displacement termination technology.

Existing solutions typically require the use of ring tongue crimp terminals which have to be crimped first at a specific location on the wire, a hole is then drilled into the mounting surface, and the product is finally mounted on the frame with a separate thread forming or self-tapping screw. The new Tyco Electronics SolKlip provides an extremely simplified solution for terminating a continuous-run ground wire.

Termination times are measured in seconds using the pre-mounted Tyco Electronics SolKlip thereby saving time and reducing wiring costs substantially. The four-point wire contact inherent in the design optimizes grounding performance and provides protection against contact problems due to its low interface resistance.

The Tyco Electronics SolKlip can be used with un-insulated copper wires from 12 AWG to 10 AWG. The retained-force nature of the contact provides a robust interface that minimizes vibration or thermally induced termination problems that often occur with traditional ground-screw connections. Termination of the wire is safely and easily accomplished toollessly by simply inserting the wire and closing the cover.

With a tensile strength of up to 36 kg, the UV-resistant enclosure provides a secure termination even in roughest environmental and assembly conditions. As an added benefit, the connection can be opened and re-terminated again up to five times.

Retrofitting the Tyco Electronics SolKlip on panels or frames can be done at any time by simply by drilling mounting hole in the frame and attaching the terminal to the frame using the integrated, self-tapping screw. This ensures a secure connection with the panel and/or frame.

The patent-pending Tyco Electronics SolKlip ground terminal supplements the existing Tyco Electronics SOLARLOK product portfolio and offers the electrician yet another valuable component for simple and fast wiring of a PV-system.

SolKlip™ – Ground Clip (continued)

3 Easy Steps to Ground Your PV System

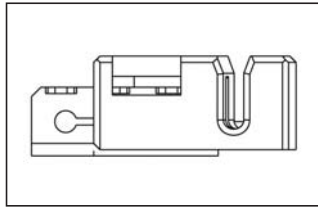

Insert ...

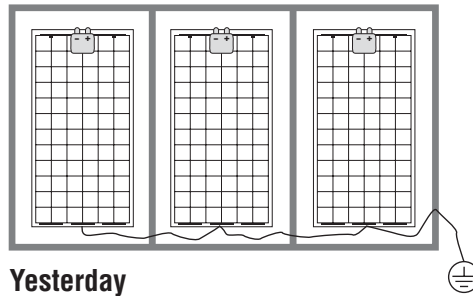

Yesterday

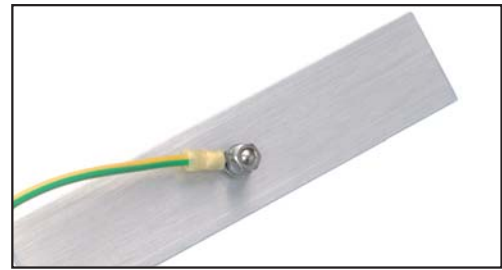

- Screw
- Washer
- Lock Washer
- Ring Tongue
- Screwdriver
- Drill
- Pliers

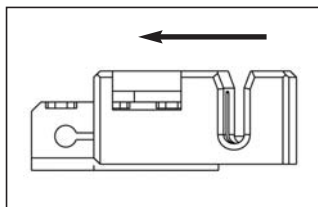

... Push ...

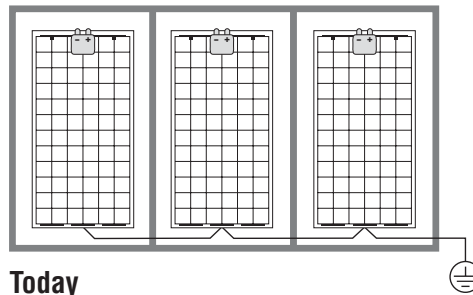

Today

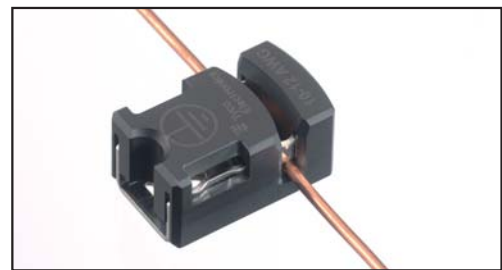

- SolKlip

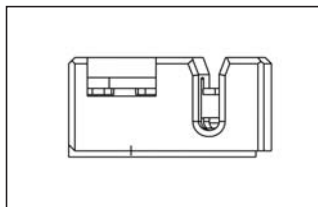

... Ready!

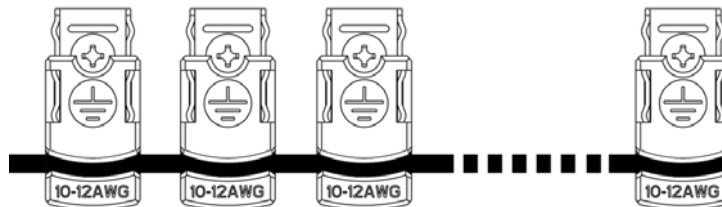

Click Click Click

Description

SolKlip ground clips are designed for solar panel grounding applications using solid un-insulated copper 10 AWG and 12 AWG.

Applications

Solar panels and related products that require grounding for safety reasons.

Applications include: wire jumpers between solar panels, solar roof tiles and between panels and the AC/DC inverters.

Electrical

The electrical performance of this product will meet the tough requirements of photovoltaic grounding applications.

Product Offering & Dimensions

SolKlip for Solar Grounding Part No. **1954381-1** to handle 12–10 AWG solid, un-insulated ground wire.

Application Tooling

No special tooling required.

Standards and Specifications

SolKlip Grounding Clip: UL 467 pending, a requirement for UL 1703 solar panel listing. UL 486A-B pending, also a requirement as part of the UL 1703 approval listing.

Materials

Housing: Durable PPT
Contact: High conductivity copper alloy

Mechanical

The mechanical properties of this product will meet the tough requirements for grounding applications laid down in the UL requirements.

Interconnection Examples

**Serial Interconnection for Junction Boxes with Cable Glands
(4.0 mm² Wiring)**

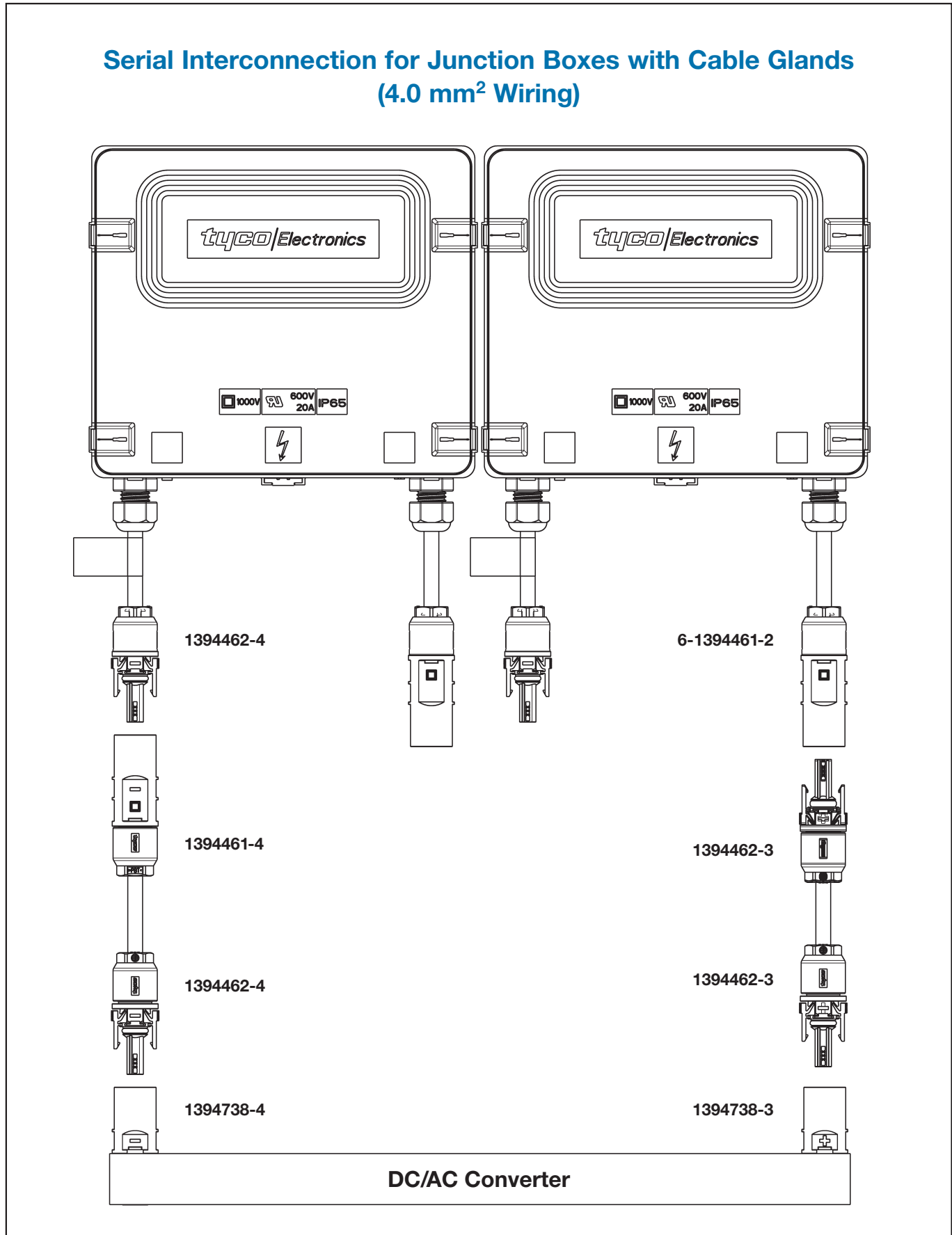

Interconnection Examples (continued)

**Serial Interconnection for Junction Boxes with Plug Connectors
(4.0 mm² Wiring)**

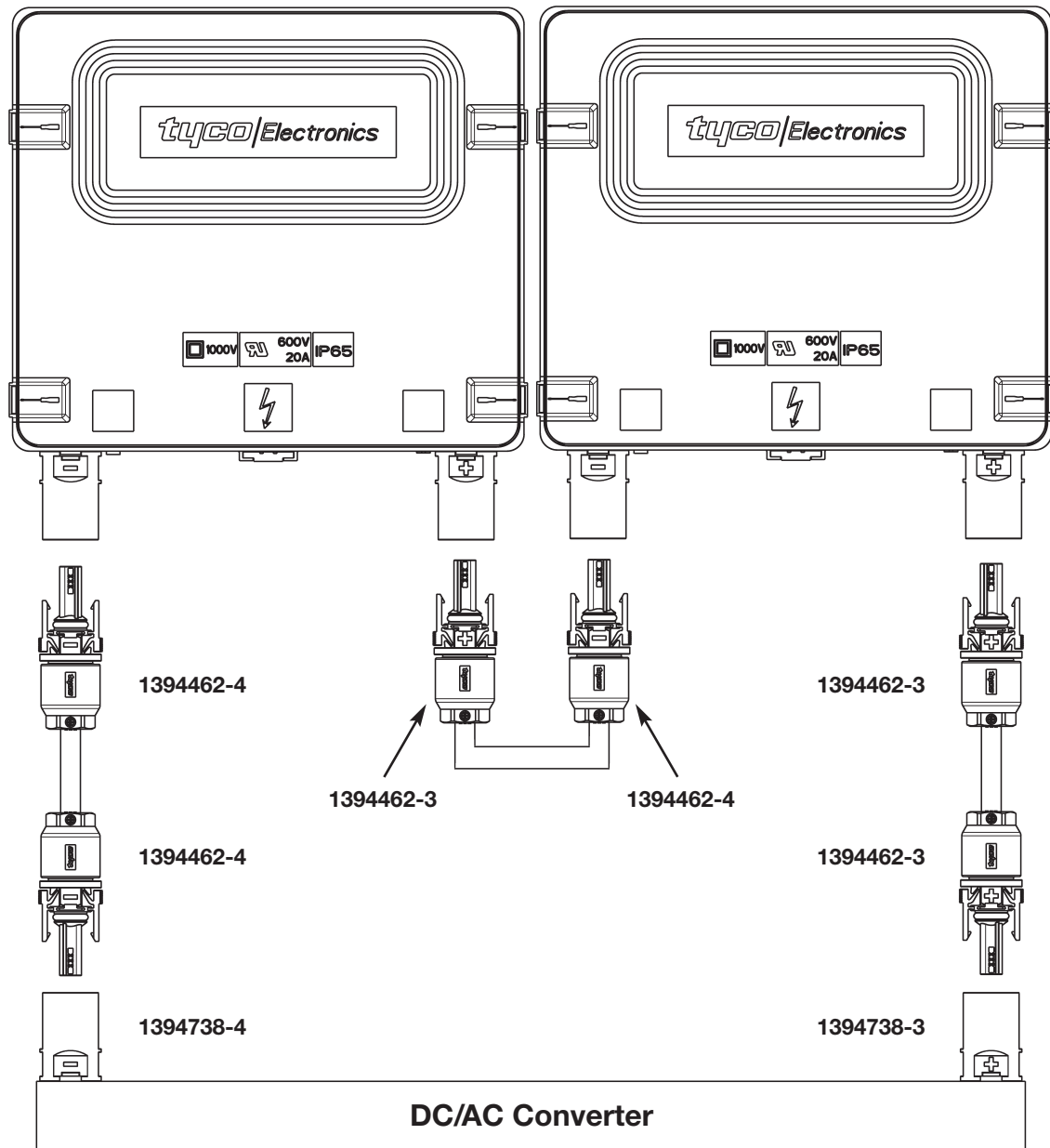

Application Tooling

Cable Assembly Tooling

**Hand Crimping Tool**

incl. Vario Crimp Head and Locator

Part Numbers

1-1579004-1 (1.5 + 2.5 mm²)**1-1579004-2** (4.0 + 6.0 mm²)**Vario Crimp Head****7-1579001-8** (1.5 + 2.5 mm²)**7-1579001-9** (4.0 + 6.0 mm²)**Hand Crimping Tool**

incl. Vario Crimp Head and Locator

Part No. **1579004-8**(for 1.5 + 2.5 + 4.0 + 6.0 mm²)**Die Set**Part No. **6-1579001-6**(for 1.5 + 2.5 + 4.0 + 6.0 mm²)**Extraction Tool**

suitable for all wire sizes

Part No. **1102855-3****Insulation Stripper**includes length stop for all wire sizes: 1.5 mm², 2.5 mm², 4.0 mm² and 6.0 mm².

Suitable for Tyco Electronics Solar Cable.

Part No. **4-1579002-2****SOLARLOK
Electric Terminator CS 200**Base Machine:
Part No. **539630-1****Adapter for Vario Crimp Head:**Part No. **1579000-4****Vario Crimp Head****(1.5 and 2.5 mm²):**Part No. **7-1579001-8****Vario Crimp Head****(4.0 and 6.0 mm²):**Part No. **7-1579001-9****Vario Crimp Head (AWG 10):**Part No. **8-1579001-2****Vario Crimp Head (AWG 12):**Part No. **5-1579001-5****Vario Crimpkopf (AWG 14):**Part No. **5-1579001-4**

Application Tooling (continued)

Junction Box
Assembly Tooling**Wire Spring Clamp Tool**

Part No. 1579007-2

**Dioden/Jumper
Spring Clamp Tool**

Part No. 1579007-5

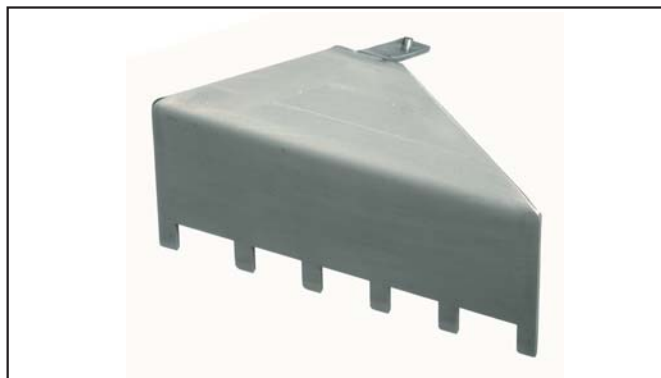
**Foil Spring Clamp Tool**Part No. 1579007-3 Large Box
Part No. 1740969-1 Medium Box
Part No. 1740969-2 Small Box**Field Service Kit**Part No. 1534858-1
(Metric Wire)**Kit includes the following parts:**

- 100 Cable Coupler (Housings, Plus and Minus coded)
- Crimp Contacts (4.0 and 6.0 mm²)
- Strain Relief
- Seals
- **Hand Crimp Tool:**
Part No. 1-1579004-2
- **Extraction Tool:**
Part No. 1102855-3
- **Insulation Stripper:**
Part No. 4-1579002-2

Assembly and Installation Guidelines

| Table of Contents | Page |
|--|------|
| SOLARLOK Plug Connectors | 24 |
| 1. General Comments | 24 |
| 2. Termination of the Cable Wires / Crimping of the Contacts | 24 |
| 3. Handling of the Connectors | 24 |
| 3.1 Selection of Sealing Grommet for Cable Connectors | 24 |
| 3.2 Connector Latching | 26 |
| 3.3 Disconnecting | 26 |
| 3.4 DC/AC Converter Receptacle | 27 |
| 4. Application Examples | 28 |
| 5. Storage | 28 |
| 6. Tooling | 28 |

SOLARLOK Plug Connector

Attention: This connector is to be used only to interconnect firmly fixed cables.

Do not disconnect under load.

Current path should only be disconnected using approved disconnect devices.

Cable assemblies shall be labeled with Part No. **1394470-1**.

To protect against shock, ensure that conductors and their associated connectors are separated from opposite polarity components.

1. General Comments

Any kind of pollution (dust, oil, humidity, etc.) during the assembly process or to the unmated connector can degrade contact and connector performance. This applies in particular to the seals and the crimping of the contacts.

A clean assembly environment is therefore essential.

2. Termination of the Cable Wires and Crimping of the Contacts

SOLARLOK connectors use different crimp contacts for various wire gauges. Possible wire gauges are 1.5 mm², 2.5 mm², 4.0 mm², 5.3 mm² und 6.0 mm² resp. AWG 16, AWG 14, AWG 12 and AWG 10.

The tools to be used are selected based upon the wire gauge.

For the application specification, please refer to specification # 114-74013.

3. Handling of the Connectors

3.1 Selection of Sealing Grommet for Cable Connectors

Use only appropriate wire gauges.

Besides the standard seal/pinch ring combination further five different seals are available.

- 4.0 mm grommet inner diameter (for insulation diameter from 3.2 to 4.3 mm), Part No. **1394465-5**
- 5.0 mm grommet inner diameter (for insulation diameter from 4.3 to 5.3 mm), Part No. **1394465-1**
- 6.0 mm grommet inner diameter (for insulation diameter from 5.3 to 6.2 mm), Part No. **1394465-2**
- 7.0 mm grommet inner diameter (for insulation diameter from 6.2 to 7.2 mm), Part No. **1394465-3**
- 8.0 mm grommet inner diameter (for insulation diameter from 7.2 to 8.0 mm), Part No. **1394465-4**

The grommet has to be matched with the outer diameter of the solar cable (see customer drawing, Part No. **1394461** and Part No. **1394462**) and the pinch ring (Part No. **1418677-2**) must be applied.

Assembly and Installation Guidelines (continued)

When assembling the connectors, the following sequence must be followed:

- ① Stripping the Wire (please refer to application specification # 114-74013)



Fig. 1

- ② Insert the stripped wire into the wire crimp barrel until it stops. While holding the wire in place, squeeze tool handles together until ratchet releases.



Fig. 2

- ③ Place seal/pinch ring combination into the connector housing until it stops.

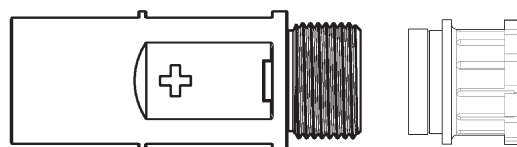

Fig. 3

- ④ Place backshell onto the connector housing.

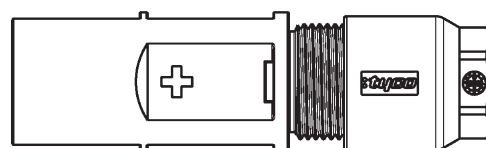

Fig. 4

- ⑤ Push contact with cable into the connector housing until you hear the contact is locked into position

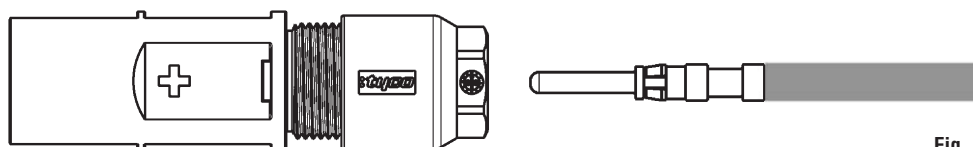

Fig. 5

- ⑥ Tighten backshell nut to 1.5 Nm

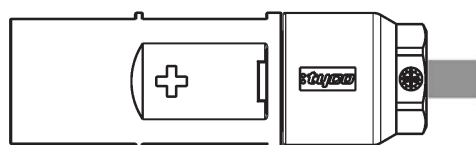

Fig. 6

Assembly and Installation Guidelines (continued)

3.2 Connector Latching

When mating the SOLARLOK connectors, ensure the following:

- Connectors labeled with a plus or minus are keyed and can only be mated to similarly marked and keyed connectors.

CAUTION:

The “neutral” designated pin connectors incorporate no keying features and must only be used for Serial Interconnection of Photovoltaic Modules. The neutral product should not be used where maintaining polarity is critical.

The polarity of the “neutral” connector must be labeled with Part No. **1394725-1** or Part No. **1394725-2** nearby the connector.

- The connector system is fully latched only when the latches are flush with the mating connector.
- After the connector is fully latched, the optional latch locking clip may be snapped into place.

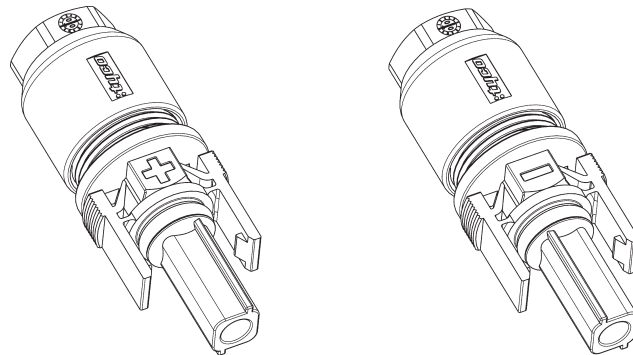

Fig. 7
(Female Connector)

3.3 Disconnecting

CAUTION: This connector must not be disconnected under load.

Disconnect circuit from load before unplugging connectors.

Cable assemblies should be labeled using Tyco Electronics Label, Part No. **1394470-1**.

Unmating of the connector

CAUTION: Do not disconnect the connector under load!

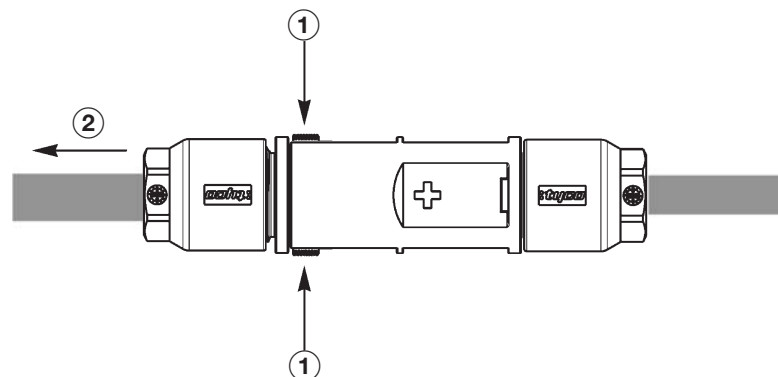

Fig. 8

- ① The locking mechanism is opened by depressing the latches.
- ② Pull out the connectors. While depressing the latches, disconnect the connector by pulling the connector halves apart.

Assembly and Installation Guidelines (continued)

- 3.4 DC/AC Converter Receptacle** ① Place a single wire seal onto the wire and strip wire (single wire seals are not available with every version).



Fig. 9

- ② Crimp the contact using the correct applicator for the wire gauge (# 114-74013)



Fig. 10

- ③ Place O-ring onto the connector housing; push in wire to stop until contact locks into the housing

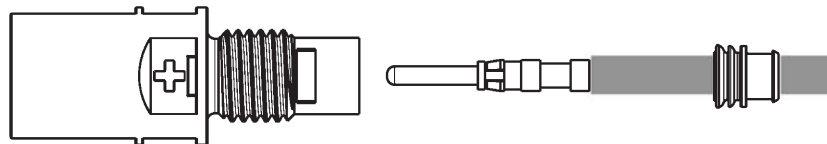

Fig. 11

- ④ Push seal into the housing

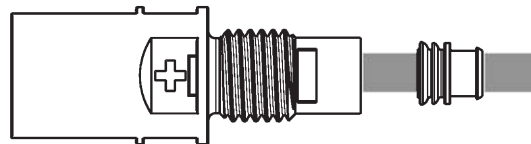

Fig. 12

- ⑤ Assembly of the cover cap (not available with every version) and mounting in front panel

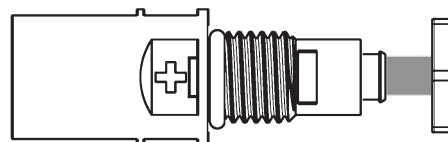

Fig. 13

- Required panel mount hole diameter: Diameter 12.5 mm.
- The panel thickness must not be under 1.0 mm.
- For environmental protection of the unmated connector, use of the covering cap is recommended.

Cover:
Part No. **1394739-1**

Assembly and Installation Guidelines (continued)

4. Application Examples

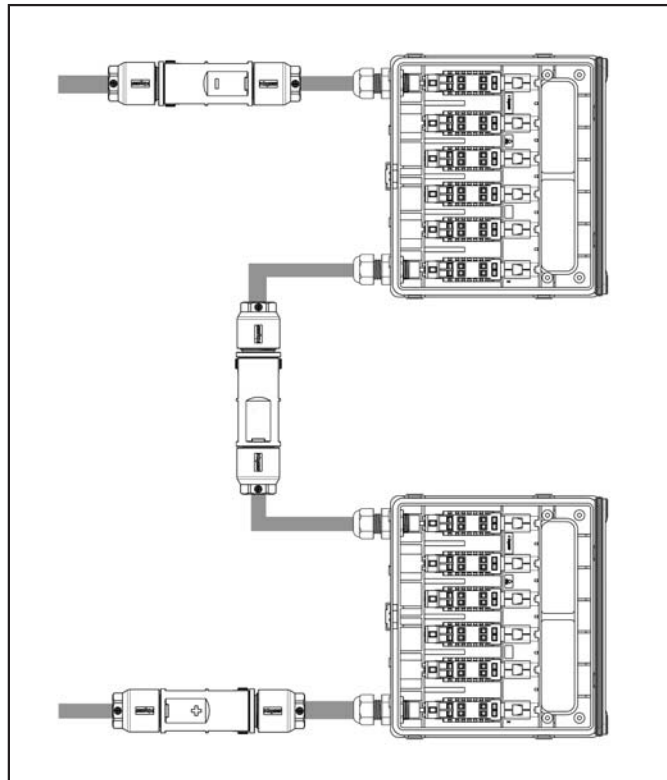

Fig. 14: Serial (Wire Diagram)

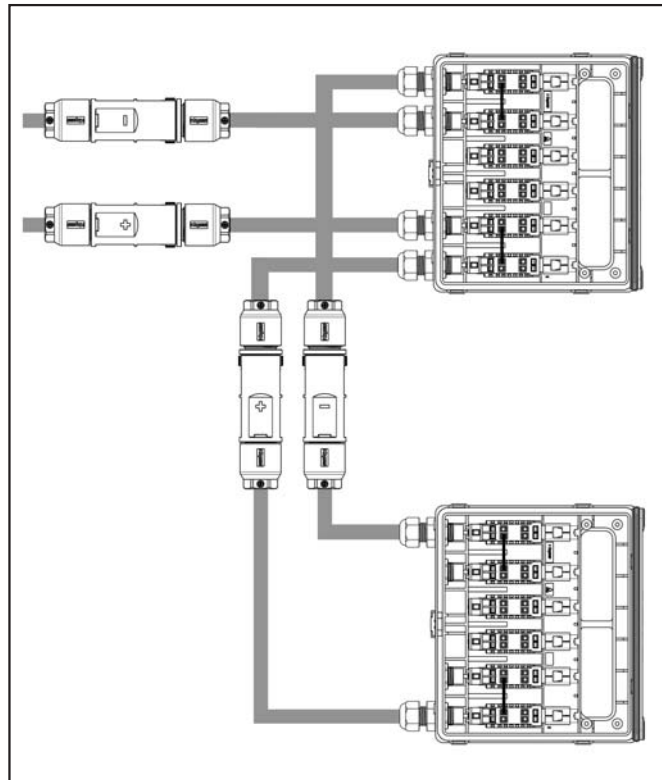

Fig. 15: Parallel (Wire Diagram)

5. Storage

See Product Specification 108-18701

6. Tooling

- The following tools are available for the contact crimping (please specify wire gauge required):
 - Hand Tool, integral Locator and Die (Part No. **1-1105851-8**), use 'HVT' position on locator
 - Hand Tool, only (Part No. **539973-1**)
- An extraction tool (Part No. **1102855-3**) is needed to disassemble the connector components. This tool is used to unlock the contact retention features, after which the contact can be removed and re-used if necessary.

Technical Description

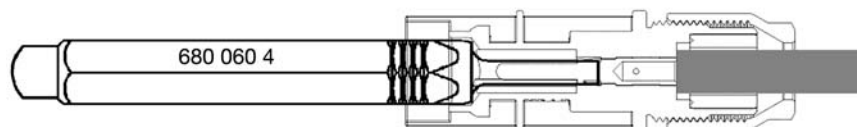

Fig. 16

Technical Data (Junction Box and One Pole Plug Connectors)

Materials

| | |
|--------------------------|--|
| Socket and Pin Contacts: | CuZn |
| Housing: | PPO, weatherproof against UV radiation and ozone |

Color

| | |
|--------------------------|-------|
| Connector, Junction Box: | Black |
|--------------------------|-------|

Electrical Features

| | |
|-------------------------------|--------------------------|
| Withstanding Voltage: | 1000 V DC |
| Current Rating: | up to 25 A |
| Contact Resistance: | $\leq 5 \text{ m}\Omega$ |
| Contact Resistance (typical): | 1 m Ω |
| Protection Class: | II |

Mechanical Features

Junction Boxes

| | |
|--------------------|--------------------------------|
| Dimensions: | Depending on junction box type |
| Temperature Range: | -40 °C to +105 °C |
| Wire Size Range: | up to AWG 12 |
| Protection Degree: | IP 65, closed |

Connector

| | |
|----------------------|---|
| Dimensions: | Diameter 18 mm, (diameter 0.71 inch) |
| Temperature Range: | -40 °C to +105 °C |
| Wire Size Range: | AWG 14, AWG 12, AWG 10 stranded wire |
| Protection Degree: | IP 67, mated |
| Contact Finish: | silver plated, |
| Mating Cycles: | 50, silver plated |
| Unmating Force: | 30–40 Newton |
| Additional Features: | Coded housing ensures mating safety Contact voltage-proof Connector with crimp technology |

| | |
|------------------|--|
| Standards | IEC 61215 Edition 2, 61646, IEC 61730, Protection Class II, UL 1703 |
|------------------|--|

Subject to Change.

Numerical Index

| Part Number | Page | Part Number | Page | Part Number | Page | Part Number | Page |
|-------------|-------------------|-------------|------------|-------------|--------|-------------|--------|
| 539630-1 | 22 | 1394470-1 | 26 | 1740210-7 | 11 | 1987376-2 | 16, 17 |
| 539973-1 | 28 | 1394470-1 | 24 | 1740210-8 | 11 | 1987376-3 | 16, 17 |
| 956297-4 | 14 | 1394723-3 | 2 | 1740210-9 | 11 | 1987376-4 | 16, 17 |
| 956297-5 | 14 | 1394723-4 | 2 | 1-1740210-0 | 11 | 1987376-5 | 16, 17 |
| 956297-6 | 14 | 1394723-5 | 3 | 1740220-1 | 6 | 1-1987376-1 | 16, 17 |
| 1-956297-4 | 14 | 1394723-6 | 3 | 1740220-2 | 6 | 1-1987376-2 | 16, 17 |
| 1-956297-5 | 14 | 1394723-9 | 3 | 1740220-3 | 6 | 1-1987376-3 | 16, 17 |
| 1-956297-6 | 14 | 1-1394723-6 | 2 | 1740220-4 | 6 | 1-1987376-4 | 16, 17 |
| 956298-4 | 14 | 2-1394723-6 | 2 | 1740277-1 | 10 | 1-1987376-5 | 16, 17 |
| 956298-5 | 14 | 1394725-1 | 26 | 1740277-2 | 10 | 2-1987376-1 | 16, 17 |
| 956298-6 | 14 | 1394725-2 | 26 | 1740425-1 | 6 | 2-1987376-2 | 16, 17 |
| 1-956298-4 | 14 | 1394738-1 | 11 | 1740425-3 | 6 | 2-1987376-3 | 16, 17 |
| 1-956298-5 | 14 | 1394738-2 | 11 | 1740479-1 | 12 | 2-1987376-4 | 16, 17 |
| 1-956298-6 | 14 | 1394738-3 | 11, 20, 21 | 1740483-1 | 12 | 2-1987376-5 | 16, 17 |
| 956299-4 | 14 | 1394738-4 | 11, 20, 21 | 1740483-2 | 12 | 3-1987376-1 | 17 |
| 956299-5 | 14 | 1394739-1 | 11, 27 | 1740493-1 | 12 | 3-1987376-2 | 17 |
| 956299-6 | 14 | 1418677-2 | 24 | 1740493-2 | 12 | 3-1987376-3 | 17 |
| 1-956299-4 | 14 | 1418867-1 | 7 | 1740657-7 | 5 | 3-1987376-4 | 17 |
| 1-956299-5 | 14 | 1418867-2 | 7 | 1740657-8 | 5 | 3-1987376-5 | 17 |
| 1-956299-6 | 14 | 1418867-5 | 7 | 1740657-9 | 5 | 4-1987376-1 | 17 |
| 1102855-3 | 22, 23, 28 | 1418867-6 | 7 | 1-1740657-0 | 5 | 4-1987376-2 | 17 |
| 1-1105851-8 | 28 | 1-1418867-2 | 7 | 1740658-1 | 5 | 4-1987376-3 | 17 |
| 1394461-1 | 9 | 1-1418867-3 | 7 | 1740658-3 | 5 | 4-1987376-4 | 17 |
| 1394461-2 | 9 | 1534226-1 | 9 | 1740658-4 | 5 | 4-1987376-5 | 17 |
| 1394461-3 | 9, 16, 17 | 1534611-1 | 10 | 1740658-5 | 5 | | |
| 1394461-4 | 9, 16, 17, 20 | 1534611-2 | 10 | 1740699-1 | 4 | | |
| | | 1534858-1 | 23 | 1740699-6 | 4 | | |
| 6-1394461-1 | 9 | 1579000-4 | 22 | 1740700-1 | 4 | | |
| 6-1394461-2 | 9, 20 | 5-1579001-4 | 22 | 1740700-3 | 4 | | |
| 6-1394461-4 | 9 | 5-1579001-5 | 22 | 1740863-1 | 8 | | |
| 6-1394461-5 | 9 | 6-1579001-6 | 22 | 1740863-2 | 8 | | |
| 6-1394461-6 | 9 | 7-1579001-8 | 22 | 1740969-1 | 23 | | |
| 1394462-1 | 9 | 7-1579001-9 | 22 | 1740969-2 | 23 | | |
| 1394462-2 | 9 | 8-1579001-2 | 22 | 1740971-1 | 4 | | |
| 1394462-3 | 9, 16, 17, 20, 21 | 4-1579002-2 | 22, 23 | 1740971-2 | 4 | | |
| | | 1579004-8 | 22 | 1740972-1 | 4 | | |
| 1394462-4 | 9, 16, 17, 20, 21 | 1-1579004-1 | 22 | 1740972-3 | 4 | | |
| | | 1-1579004-2 | 22, 23 | 1954381-1 | 19 | | |
| 5-1394462-5 | 9 | 1579007-2 | 23 | 1986164-2 | 14 | | |
| 5-1394462-6 | 9 | 1579007-3 | 23 | 1986164-3 | 14 | | |
| 1394465-1 | 24 | 1579007-5 | 23 | 1986165-2 | 14 | | |
| 1394465-2 | 24 | 1740210-1 | 11 | 1986165-3 | 14 | | |
| 1394465-3 | 24 | 1740210-2 | 11 | 1986166-2 | 14 | | |
| 1394465-4 | 24 | 1740210-3 | 11 | 1986166-3 | 14 | | |
| 1394465-5 | 24 | 1740210-4 | 11 | 1987376-1 | 16, 17 | | |

Restriction on the Use of Hazardous Substances (RoHS)

Restriction on the Use of Hazardous Substances (RoHS)

At Tyco Electronics, we're ready to support your RoHS requirements. We've assessed more than 1.5 million end items/components for RoHS compliance, and issued new part numbers where any change was required to eliminate the restricted materials. Part numbers in this catalog are identified as:

RoHS Compliant

Part numbers in this catalog are RoHS Compliant, unless marked otherwise.

These products comply with European Union Directive 2002/95/EC as amended 1 January 2006 that restricts the use of lead, mercury, cadmium, hexavalent chromium, PBB, and PBDE in certain electrical and electronic products sold into the EU as of 1 July 2006.

Note: For purposes of this Catalog, included within the definition of RoHS Compliant are products that are clearly "Out of Scope" of the RoHS Directive such as hand tools and other non-electrical accessories.

Non-RoHS Compliant

These part numbers are identified with a "◆" symbol. These products do not comply with the material restrictions of the European Union Directive 2002/95/EC.

5 of 6 Compliant

A "●" symbol identifies these part numbers. These products do not fully comply with the European Union Directive 2002/95/EC because they contain lead in solderable interfaces (they do not contain any of the other five restricted substances above allowable limits). However, these products may be suitable for use in RoHS applications where there is an application-based exception for lead in solders, such as the server, storage, or networking infrastructure exemption.

Note: Information regarding RoHS compliance is provided based on reasonable inquiry of our suppliers and represents our current actual knowledge based on the information provided by our suppliers. This information is subject to change. For latest compliance status, refer to our website referenced below.

Getting the Information You Need

Our comprehensive on-line RoHS Customer Support Center provides a forum to answer your questions and support your RoHS needs. A RoHS FAQ (Frequently Asked Questions) is available with links to more detailed information. You can also submit RoHS questions and receive a response within 24 hours during a normal work week. The Support Center also provides:

- Cross-Reference from Non-compliant to Compliant Products
- Ability to browse RoHS Compliant Products in our on-line catalog: <http://ecommas.tycoelectronics.com/commerce/alt/RohsAltHome.do>
- Downloadable Technical Data Customer Information Presentation
- More detailed information regarding the definitions used above

RoHS
Customer
Support
Center 

So whatever your questions when it comes to RoHS, we've got the answers at www.tycoelectronics.com/leadfree

Engineering Notes



Americas

Argentina – Buenos Aires
Phone: +54-11-4733-2200
Fax: +54-11-4733-2211

Brasil – São Paulo
Phone: +55-11-3611-1311
Fax: +55-11-3611-0397

Canada – Toronto
Phone: +1-905-475-6222
Fax: +1-905-474-5520
Product Information Center:
Phone: +1-905-470-4425
Fax: +1-905-474-5525

Colombia – Bogota
Phone: +57-1-231-9398
Fax: +57-1-660-0206

Mexico – Mexico City
Phone: +52-55-1106-0800
+01-800-733-8926
Fax: +52-55-1106-0901

For Latin/South American Countries not shown
Phone: +54-11-4733-2015
Fax: +54-11-4733-2083

United States
Harrisburg, PA
Phone: +1-717-564-0100
Fax: +1-717-986-7575
Product Information Center:
Phone: +1-800-522-6752
Fax: +1-717-986-7575
Troy, MI
Phone: +1-248-273-3359
Fax: +1-248-273-3322

Asia/Pacific

Australia – Sydney
Phone: +61-2-9554-2600
Fax: +61-2-9502-2556
Product Information Center:
Phone: +61-2-9840-8200
Fax: +61-2-9634-6188

India – Bangalore
Phone: +91-80-285-40800
Fax: +91-80-285-40820

Indonesia – Jakarta
Phone: +65-6482-0311
Fax: +65-6482-1012

Japan – Kawasaki, Kanagawa
Phone: +81-44-844-8111
Fax: +81-44-812-3207
Product Information Center:
Phone: +81-44-844-8013
Fax: +81-44-812-3200

Korea – Seoul
Phone: +82-2-3415-4500
Fax: +82-2-3486-3810

Malaysia – Selangor
Phone: +60-3-7805-3055
Fax: +60-3-7805-3066

New Zealand – Auckland
Phone: +64-9-634-4580
Fax: +64-9-634-4586

Philippines – Makati City
Phone: +632-848-0171
Fax: +632-867-8661

People's Republic of China
Hong Kong
Phone: +852-2735-1628
Fax: +852-2735-0243

Shanghai
Phone: +86-21-2407-1588
Fax: +86-21-2407-1599

Singapore – Singapore
Phone: +65-6482-0311
Fax: +65-6482-1012

Taiwan – Taipei
Phone: +886-2-8768-2788
Fax: +886-2-8768-2268

Thailand – Bangkok
Phone: +66-2-955-0500
Fax: +66-2-955-0505

Vietnam – Ho Chi Minh City
Phone: +84-8-930-5546
Fax: +84-8-930-3443

Europe/Middle East/Africa

Austria – Vienna
Phone: +43-1-905-60-0
Fax: +43-1-905-60-1333
Product Information Center:
Phone: +43-1-905-60-1249
Fax: +43-1-905-60-1251

Belarus – Minsk
Phone: +375-17-237-47-94
Fax: +375-17-237-47-94

Belgium – Kessel-Lo
Phone: +32-16-352-300
Fax: +32-16-352-352

Bulgaria – Sofia
Phone: +359-2-971-2152
Fax: +359-2-971-2153

Czech Republic and Slovakia
Czech Republic – Kurim
Phone: +420-541-162-111
Fax: +420-541-162-223
Product Information Center:
Phone: +420-541-162-113
Fax: +420-541-162-132

Denmark – Glostrup
Phone: +45-43-48-04-00
Fax: +45-43-44-14-14

Egypt – Cairo
Phone: +202-419-2334
Fax: +202-417-7647

Estonia – Tartu
Phone: +372-5138-274
Fax: +372-7400-779

Finland – Helsinki
Phone: +358-95-12-34-20
Fax: +358-95-12-34-250

France – Cergy-Pontoise Cedex
Phone: +33-1-3420-8888
Fax: +33-1-3420-8600
Product Information Center:
Phone: +33-1-3420-8686
Fax: +33-1-3420-8623

France Export Divisions –
Cergy-Pontoise Cedex
Phone: +33-1-3420-8804
Fax: +33-1-3420-8699

Germany – Bensheim
Phone: +49-6251-133-0
Fax: +49-6251-133-1600
Product Information Center:
Phone: +49-6251-133-1999
Fax: +49-6251-133-1988

Greece – Athens
Phone: +30-210-9370-396/397
Fax: +30-210-9370-655

Hungary – Budapest
Phone: +36-1-289-1000
Fax: +36-1-289-1010
Product Information Center:
Phone: +36-1-289-1016
Fax: +36-1-289-1017

Ireland – Dublin
Phone: +353-1-866-5612
Fax: +353-1-866-5714

Israel – Petach-Tikva
Phone: +972-3-929-0999
Fax: +972-3-919-1088

Italy – Collegno (Torino)
Phone: +39-011-4012-111
Fax: +39-011-4031-116
Product Information Center:
Phone: +39-011-4012-428
Fax: +39-011-40-287-428

Lithuania and Latvia
Lithuania – Vilnius
Phone: +370-5-213-1402
Fax: +370-5-213-1403
Product Information Center:
Phone: +370-5-211-3016
Fax: +370-5-213-1403

Netherlands – 's-Hertogenbosch
Phone: +31-73-6246-246
Fax: +31-73-6212-365
Product Information Center:
Phone: +31-73-6246-999
Fax: +31-73-6246-998

Norway – Nesbru
Phone: +47-66-77-88-50
Fax: +47-66-77-88-55

Poland – Warsaw
Phone: +48-22-4576-700
Fax: +48-22-4576-720
Product Information Center:
Phone: +48-22-4576-704
Fax: +48-22-4576-720

Romania – Bucharest
Phone: +40-21-311-3479/3596
Fax: +40-21-312-0574

Russia – Moscow
Phone: +7-495-790-7902
Fax: +7-495-721-1893
Product Information Center:
Phone: +7-495-790-7902-404
Fax: +7-495-790-7902-401

Russia – St. Petersburg
Phone: +7-812-718-8192
Fax: +7-812-718-8193

Slovenia – Ljubljana
Phone: +386-1561-3270
Fax: +386-1561-3240

South Africa – Port Elizabeth
Phone: +27-41-503-4500
Fax: +27-41-581-0440

Spain – Barcelona
Phone: +34-93-291-0330
Fax: +34-93-201-7879

Sweden – Upplands Väsby
Phone: +46-8-50-72-50-00
Fax: +46-8-50-72-50-01

Switzerland – Steinach
Phone: +41-71-447-0447
Fax: +41-71-447-0444

Turkey – Istanbul
Phone: +90-212-281-8181-83
+90-212-282-5130/5430
Fax: +90-212-281-8184

Ukraine – Kiev
Phone: +380-44-206-2265
Fax: +380-44-206-2264
Product Information Center:
Phone: +380-44-206-2265
Fax: +380-44-206-2264

United Kingdom –
Stanmore, Middlesex
Phone: +44-8706-080208
Fax: +44-208-954-6234
Product Information Center:
Freephone (UK only):
0800-267-666
Phone: +44-8706-080208
Fax: +44-208-420-8095

Tyco Electronics AMP GmbH

Siemensstr. 13
67346 Speyer / Germany
Phone: +49-(0)6232-30-2520
Fax: +49-(0)6232-30-2243

www.tycoelectronics.com
AMP, SOLARLOK, SOLKLIP, TE Logo and
Tyco Electronics are trademarks.

© 2008 Tyco Electronics Ltd.
889753-3 Revised 6-2008 5M ST

X-ON Electronics

Largest Supplier of Electrical and Electronic Components

Click to view similar products for te connectivity manufacturer:

Other Similar products are found below :

[570416-000](#) [CLTEQ-M81CE-SSRELAY-4-20V](#) [4-1633138-8](#) [D38999/24FJ4AN](#) [4-1195131-0](#) [650069-000](#) [SMD100-2](#) [2EDL4CM](#)
[DTS20W19-11PD-3028](#) [DTS20W19-11PD-3028-LC](#) [DTS20W19-32SD-3028-LC](#) [DTS20W19-32SD-3028](#) [NC6-P104-06](#) [TXR64AB90-](#)
[3616AI](#) [DTS26F21-41HE](#) [DTS26F21-41AE](#) [DTS26F21-41PE-LC](#) [DTS26F21-11SE-3028-LC](#) [D38999/24WF32JE](#) [D38999/24WF32SE-LC](#)
[DTS24W19-32HE](#) [D38999/20JB35HA](#) [D38999/24WJ20PA](#) [164-8033-08](#) [D38999/24FF32JE](#) [D38999/24FF32SE-LC](#) [D38999/24WF32JB](#)
[D38999/24WG11HA](#) [D38999/24WG11HN](#) [MS27467T21F11H](#) [DJT16E21-11HA](#) [DTS24F19-32HE](#) [DTS20W19-32SA-3028-LC](#) [DTS24F19-](#)
[11SC-3028-LC](#) [DTS24F19-11SC-3028](#) [DJT14E13-98HB](#) [D38999/20WC8BB](#) [1-330599-5](#) [DTS24F21-41HN-LC](#) [DTS24F21-41HN](#)
[DTS24F21-41AN](#) [DTS24F21-39HN](#) [DTS24F21-41PN-LC](#) [AFD50-10-6SN-1A-LC](#) [DJT10F17-26HC](#) [DTS24W19-32HB](#) [ACT20JE99HA](#)
[DJT10E17-26HC](#) [DJT10E17-26HN](#) [DJT10F17-26HA](#)