



# SLIM8 A/Z

## SMALL, ALUMINIUM, SURFACE PROFILE

### MAŁY, ALUMINIOWY PROFIL NAWIERZCHNIOWY



- decorative lighting profile
- universal application
- Slick socket
- 2 channels for mounting bracket (with or without wall distance)
- painted holders
- maximum LED strip width: 8 mm
- profil dekoracyjno-oświetleniowy
- uniwersalne zastosowanie
- gniazdo Slick
- 2 rowki - 2 poziomy przymocowania uchwyty (z dystansem od ściany lub bez)
- malowane uchwyty
- maksymalna szerokość taśmy LED: 8 mm

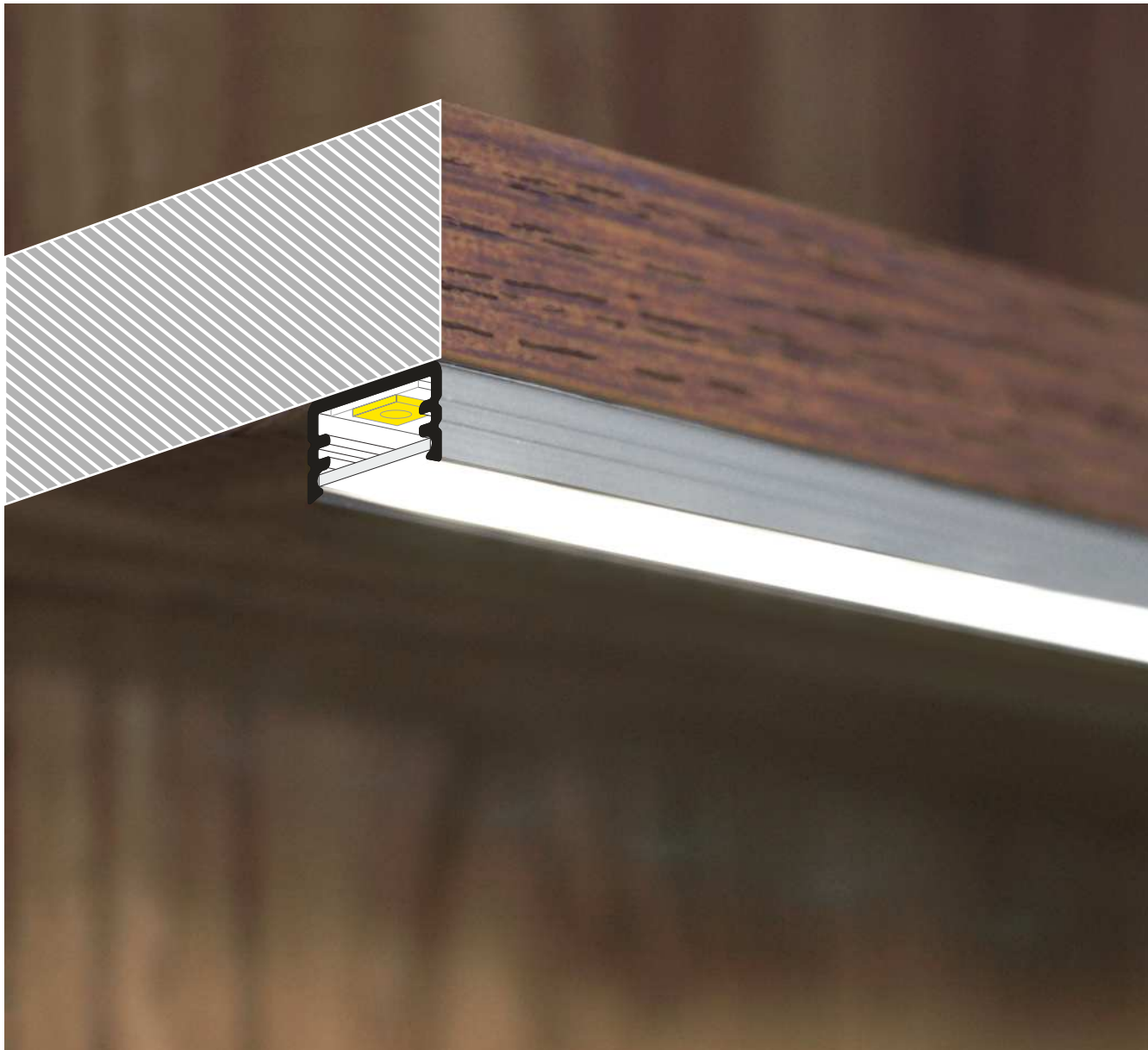

## SIMILAR IN THE OFFER / PODOBNE W OFERCIE



SMART10  
A/Z



SURFACE10  
BC/UX



BEGTON12  
J/S



SURFACE14  
EF/TY





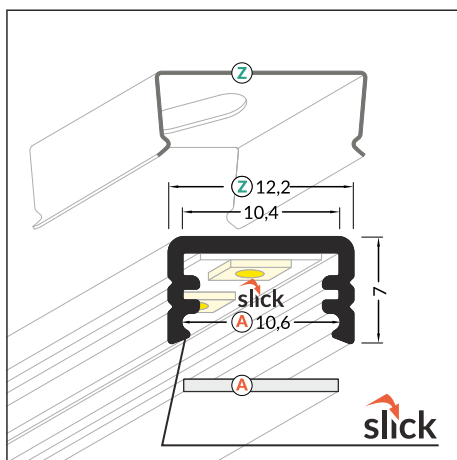
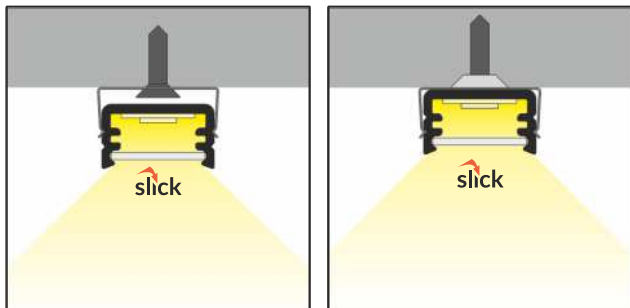
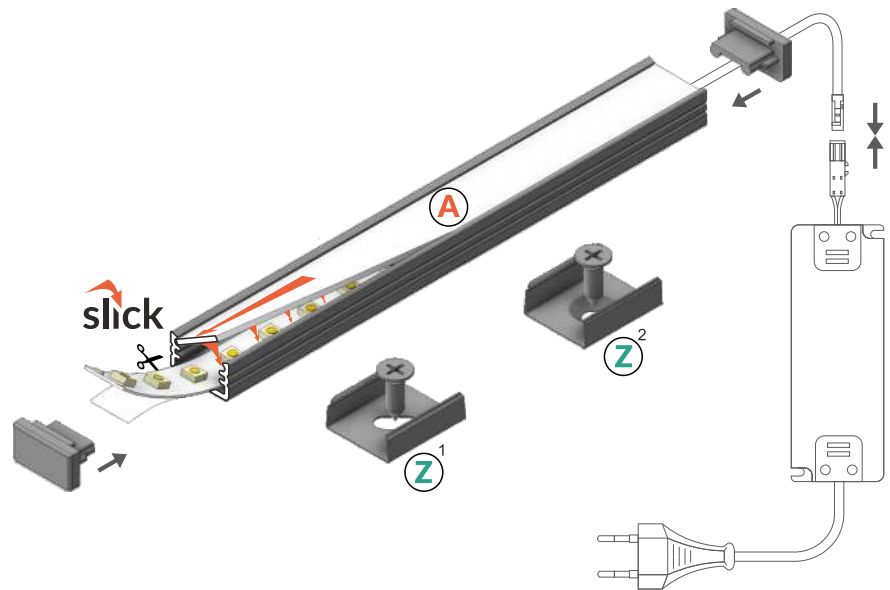

# SLIM8 A/Z

- A** slide cover  
klosz A wsuwany
- Z**<sup>1</sup> Z flexible mounting plate  
uchwyt Z sprężysty
- Z**<sup>2</sup> cone Z flexible mounting plate  
uchwyt Z sprężysty cone



INDEX = 1 pc, length 2000 mm  
package = 10 pcs  
INDEKS = 1 szt., długość 2000 mm  
opakowanie = 10 szt.

-  white painted  
biały malowany  
**89030001**
-  anodized  
anodowany  
**89030020**
-  black anodized  
czarny anodowany  
**89030021**
-  raw aluminium  
surowe aluminium  
**89030000**

Available lengths / Dostępne długości  
1000 mm, 2000 mm, 3000 mm, 4000 mm



## COVERS / KLOSZE

**A slide cover**  
colours: transparent, frosted, white  
material: PC, PP, PP

klosz **A** wsuwany  
kolory: transparentny, szron, mleczny  
materiał: PC, PP, PP

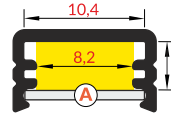
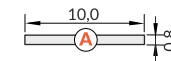

**Note!** Dimensions of the space to install LED source  
**Uwaga!** Wymiary przestrzeni do zamontowania źródła LED



INDEX = 1 pc, length 2000 mm  
package = 10 pcs  
INDEKS = 1 szt., długość 2000 mm  
opakowanie = 10 szt.

**A transparent / A transparentny**  
89070016

**A frosted / A szron**  
89070039

**A white / A mleczny**  
89070038

## ENDINGS / ZAŚLEPKI

**SLIM8 ending**  
colours: white, silver, black, grey  
material: ABS

zaślepka SLIM8  
kolory: biały, srebrny, czarny, szary  
materiał: ABS

**SLIM8 ending with hole**  
colours: white, silver, black, grey  
material: ABS

zaślepka SLIM8 z otworem  
kolory: biały, srebrny, czarny, szary  
materiał: ABS

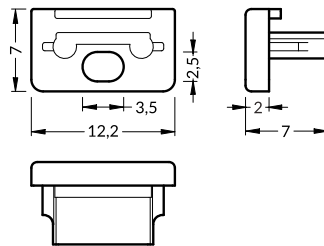

INDEX = 1 set  
package of 10 sets = 20 pcs  
INDEKS = 1 komplet, opakowanie zawiera 10 kompletów = 20 szt.

- white / białe
 

|                     |                         |
|---------------------|-------------------------|
| with hole z otworem | without hole bez otworu |
| 89960001            | 89040001                |
- silver / srebrne
 

|                     |                         |
|---------------------|-------------------------|
| with hole z otworem | without hole bez otworu |
| 89960040            | 89040040                |
- black / czarne
 

|                     |                         |
|---------------------|-------------------------|
| with hole z otworem | without hole bez otworu |
| 89960002            | 89040002                |
- grey / szare
 

|                     |                         |
|---------------------|-------------------------|
| with hole z otworem | without hole bez otworu |
| 89960022            | 89040022                |

## MOUNTINGS / MOCOWANIA

**Z flexible mounting plate**  
colours: white, inox, black  
material: stainless steel

uchwyt **Z** sprężysty  
kolory: biały, inox, czarny  
materiał: stal nierdzewna

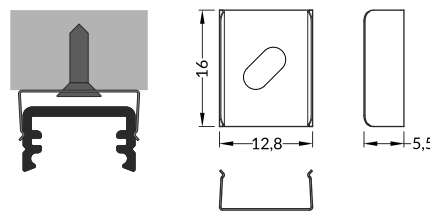

**cone Z flexible mounting plate**  
colours: white, inox, black  
material: stainless steel

uchwyt **Z** sprężysty cone  
kolory: biały, inox, czarny  
materiał: stal nierdzewna

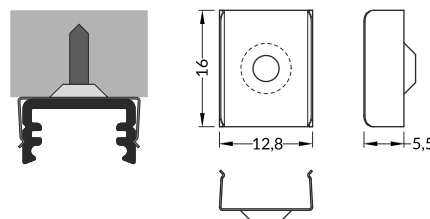

**SLIM8 simple holder**  
material: zinc coated steel

uchwyt SLIM8 prosty  
materiał: stal ocynkowana

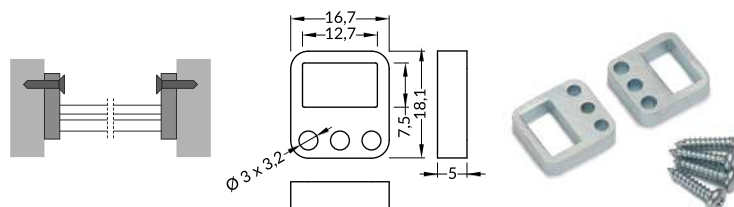

INDEX = 1 set  
package of 10 sets = 20 pcs  
INDEKS = 1 komplet, opakowanie zawiera 10 kpl = 20 szt.

**Z flexible mounting plate**  
uchwyt **Z** sprężysty

- white biały 89270001
- inox inox 89270019
- black czarny 89270002

**cone Z flexible mounting plate**  
uchwyt **Z** sprężysty cone

- white biały 89980001
- inox inox 89980019
- black czarny 89980002

INDEX = 1 set = 2 pcs  
INDEKS = 1 komplet = 2 szt.

simple holder  
uchwyt prosty

- zinc coated stal ocynkowana 89110030





## CONNECTORS / ŁĄCZNIKI

**SLIM8 L connector**  
colours: white, anodized, black  
material: aluminium

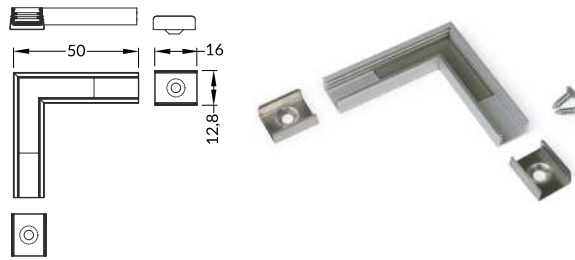
łącznik L SLIM8  
kolory: biały, anodowany, czarny  
materiał: aluminium



INDEX = 1 set  
INDEKS = 1 komplet

-  white painted  
biały malowany  
89150001
-  anodized  
anodowany  
89150020
-  black anodized  
czarny anodowany  
89150021



Made in Poland  
Wyprodukowane w Polsce



EU-registered industrial design  
Wzory przemysłowe EU

TOPMET LIGHT Kłósowicz Wiśniewski i Wspólnik Sp. j. ADDRESS: Ostrowska 354, 61-312 Poznań, POLAND  
tel. +48 61 87 27 500, fax. +48 61 87 27 518 biuro@topmet.pl, www.topmet.pl

The catalogue is not an offer under Polish Civil Code regulations. Colours of particular products may vary slightly from colours shown in pictures. The dimensions given are approximate and can not be a reason for complaint. TOPMET Company reserves the right to make technical changes.  
Folder nie stanowi oferty w myśl przepisów Kodeksu Cywilnego. Aktualną ofertę firmy stanowi cennik. Kolory poszczególnych produktów mogą się nieznacznie różnić od kolorów prezentowanych na zdjęciach. Podane wymiary są wymiarami orientacyjnymi i nie mogą stanowić podstawy reklamacji. Firma TOPMET zastrzega sobie prawo do wprowadzania zmian technicznych.

brochure designer • proj. folderu: M. Kędziora, A. Szafran 11.2016. photo • fot. K. Samulska, A. Szafran, L. Wesolowski

# X-ON Electronics

Largest Supplier of Electrical and Electronic Components

*Click to view similar products for [LED Lighting Mounting Accessories](#) category:*

*Click to view products by [Topmet](#) manufacturer:*

Other Similar products are found below :

[3635](#) [PALBF18](#) [C16142\\_HEKLA-SOCKET-K](#) [3SU1900-0BC31-0AA0](#) [3SU1900-0BC31-0NB0](#) [2213118-2](#) [47.319.6380.50](#) [3SU1401-2BB40-1AA0](#) [3SU1401-2BB60-1AA0](#) [1SFA611621R1041](#) [23110040](#) [23120022](#) [23130000](#) [68550022](#) [68550040](#) [70290000](#) [70290022](#) [70290040](#) [70300022](#) [70300040](#) [76620000](#) [76990022](#) [77280022](#) [77980022](#) [77990001](#) [77990002](#) [77990040](#) [83130001](#) [83130040](#) [83150001](#) [83150022](#) [83150040](#) [83980001](#) [83980040](#) [83990001](#) [83990022](#) [83990040](#) [84040022](#) [84510002](#) [86050038](#) [86180003](#) [89080002](#) [89080022](#) [89140002](#) [89980002](#) [89980019](#) [98050040](#) [A1070001](#) [A1070002](#) [A2070001](#)