

# BZX84BxxxLT1G, BZX84CxxxLT1G Series, SZBZX84BxxxLT1G, SZBZX84CxxxLT1G Series

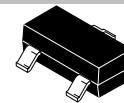

ON Semiconductor®

[www.onsemi.com](http://www.onsemi.com)



SOT-23  
CASE 318  
STYLE 8



## Zener Voltage Regulators

### 250 mW SOT-23 Surface Mount

This series of Zener diodes is offered in the convenient, surface mount plastic SOT-23 package. These devices are designed to provide voltage regulation with minimum space requirement. They are well suited for applications such as cellular phones, hand held portables, and high density PC boards.

#### Features

- 250 mW Rating on FR-4 or FR-5 Board
- Zener Breakdown Voltage Range – 2.4 V to 75 V
- Package Designed for Optimal Automated Board Assembly
- Small Package Size for High Density Applications
- ESD Rating of Class 3 (> 16 kV) per Human Body Model
- Tight Tolerance Series Available (See Page 4)
- SZ Prefix for Automotive and Other Applications Requiring Unique Site and Control Change Requirements; AEC-Q101 Qualified and PPAP Capable
- These Devices are Pb-Free and are RoHS Compliant

#### Mechanical Characteristics

**CASE:** Void-free, transfer-molded, thermosetting plastic case

**FINISH:** Corrosion resistant finish, easily Solderable

**MAXIMUM CASE TEMPERATURE FOR SOLDERING PURPOSES:**

260°C for 10 Seconds

**POLARITY:** Cathode indicated by polarity band

**FLAMMABILITY RATING:** UL 94 V-0

#### MARKING DIAGRAM

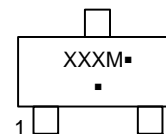

XXX = Device Code  
M = Date Code\*  
▪ = Pb-Free Package

(Note: Microdot may be in either location)

\*Date Code orientation may vary depending upon manufacturing location.

#### ORDERING INFORMATION

| Device          | Package             | Shipping†               |
|-----------------|---------------------|-------------------------|
| BZX84CxxxLT1G   | SOT-23<br>(Pb-Free) | 3,000 /<br>Tape & Reel  |
| SZBZX84CxxxLT1G | SOT-23<br>(Pb-Free) | 3,000 /<br>Tape & Reel  |
| BZX84CxxxLT3G   | SOT-23<br>(Pb-Free) | 10,000 /<br>Tape & Reel |
| SZBZX84CxxxLT3G | SOT-23<br>(Pb-Free) | 10,000 /<br>Tape & Reel |
| BZX84BxxxLT1G   | SOT-23<br>(Pb-Free) | 3,000 /<br>Tape & Reel  |
| SZBZX84BxxxLT1G | SOT-23<br>(Pb-Free) | 3,000 /<br>Tape & Reel  |
| BZX84BxxxLT3G   | SOT-23<br>(Pb-Free) | 10,000 /<br>Tape & Reel |
| SZBZX84BxxxLT3G | SOT-23<br>(Pb-Free) | 10,000 /<br>Tape & Reel |

†For information on tape and reel specifications, including part orientation and tape sizes, please refer to our Tape and Reel Packaging Specification Brochure, BRD8011/D.

#### DEVICE MARKING INFORMATION

See specific marking information in the device marking column of the Electrical Characteristics table on page 3 of this data sheet.

\*For additional information on our Pb-Free strategy and soldering details, please download the ON Semiconductor Soldering and Mounting Techniques Reference Manual, SOLDERRM/D.

# BZX84BxxxLT1G, BZX84CxxxLT1G Series, SZBZX84BxxxLT1G, SZBZX84CxxxLT1G Series

## MAXIMUM RATINGS

| Rating   | Symbol          | Max         | Unit                       |
|--|-----------------|-------------|----------------------------|
| Total Power Dissipation on FR-5 Board,<br>(Note 1) @ $T_A = 25^\circ\text{C}$<br>Derated above $25^\circ\text{C}$        | $P_D$           | 250         | mW                         |
| Thermal Resistance, Junction-to-Ambient  | $R_{\theta JA}$ | 2.0         | $\text{mW}/^\circ\text{C}$ |
|  |                 | 500         | $^\circ\text{C}/\text{W}$  |
| Total Power Dissipation on Alumina<br>Substrate, (Note 2) @ $T_A = 25^\circ\text{C}$<br>Derated above $25^\circ\text{C}$ | $P_D$           | 300         | mW                         |
| Thermal Resistance, Junction-to-Ambient  | $R_{\theta JA}$ | 2.4         | $\text{mW}/^\circ\text{C}$ |
|  |                 | 417         | $^\circ\text{C}/\text{W}$  |
| Junction and Storage Temperature Range   | $T_J, T_{stg}$  | -65 to +150 | $^\circ\text{C}$           |

Stresses exceeding those listed in the Maximum Ratings table may damage the device. If any of these limits are exceeded, device functionality should not be assumed, damage may occur and reliability may be affected.

- FR-5 = 1.0 X 0.75 X 0.62 in.
- Alumina = 0.4 X 0.3 X 0.024 in., 99.5% alumina.

## ELECTRICAL CHARACTERISTICS

(Pinout: 1-Anode, 2-No Connection, 3-Cathode) ( $T_A = 25^\circ\text{C}$  unless otherwise noted,  $V_F = 0.90\text{ V Max.}$  @  $I_F = 10\text{ mA}$ )

| Symbol       | Parameter   |
|--------------|---|
| $V_Z$        | Reverse Zener Voltage @ $I_{ZT}$                    |
| $I_{ZT}$     | Reverse Current                                     |
| $Z_{ZT}$     | Maximum Zener Impedance @ $I_{ZT}$                  |
| $I_R$        | Reverse Leakage Current @ $V_R$                     |
| $V_R$        | Reverse Voltage                                     |
| $I_F$        | Forward Current                                     |
| $V_F$        | Forward Voltage @ $I_F$                             |
| $\Theta V_Z$ | Maximum Temperature Coefficient of $V_Z$            |
| C            | Max. Capacitance @ $V_R = 0$ and $f = 1\text{ MHz}$ |



# BZX84BxxxLT1G, BZX84CxxxLT1G Series, SZBZX84BxxxLT1G, SZBZX84CxxxLT1G Series

## ELECTRICAL CHARACTERISTICS – BZX84CxxxLT1 SERIES (STANDARD TOLERANCE)

(Pinout: 1-Anode, 2-No Connection, 3-Cathode) (T<sub>A</sub> = 25°C unless otherwise noted, V<sub>F</sub> = 0.90 V Max. @ I<sub>F</sub> = 10 mA)  
 (Devices listed in **bold, italic** are ON Semiconductor Preferred devices.)

| Device*                 | Device Marking | V <sub>Z1</sub> (Volts)<br>@ I <sub>ZT1</sub> = 5 mA<br>(Note 3) |            |             | Z <sub>ZT1</sub> (Ω)<br>@ I <sub>ZT1</sub> = 5 mA   | V <sub>Z2</sub> (V)<br>@ I <sub>ZT2</sub> = 1 mA<br>(Note 3) |             | Z <sub>ZT2</sub> (Ω)<br>@ I <sub>ZT2</sub> = 1 mA     | V <sub>Z3</sub> (V)<br>@ I <sub>ZT3</sub> = 20 mA<br>(Note 3) |             | Z <sub>ZT3</sub> (Ω)<br>@ I <sub>ZT3</sub> = 20 mA   | Max Reverse Leakage Current |                        | θ <sub>VZ</sub> (mV/k)<br>@ I <sub>ZT1</sub> = 5 mA       |             | C (pF)<br>@ V <sub>R</sub> = 0<br>f = 1 MHz |
|-------------------------|----------------|--|------------|-------------|---|--|-------------|---|---|-------------|--|-----------------------------|------------------------|---|-------------|---|
|                         |                | Min  | Nom        | Max         |   | Min  | Max         |   | Min   | Max         |  | I <sub>R</sub> (μA)         | V <sub>R</sub> (Volts) | Min   | Max         |   |
| BZX84C2V4LT1G           | Z11            | 2.2  | 2.4        | 2.6         | 100   | 1.7  | 2.1         | 600   | 2.6   | 3.2         | 50   | 50                          | 1                      | -3.5  | 0           | 450   |
| BZX84C2V7LT1G           | Z12            | 2.5  | 2.7        | 2.9         | 100   | 1.9  | 2.4         | 600   | 3   | 3.6         | 50   | 20                          | 1                      | -3.5  | 0           | 450   |
| BZX84C3V0LT1G           | Z13            | 2.8  | 3          | 3.2         | 95  | 2.1  | 2.7         | 600   | 3.3   | 3.9         | 50   | 10                          | 1                      | -3.5  | 0           | 450   |
| BZX84C3V3LT1G           | Z14            | 3.1  | 3.3        | 3.5         | 95  | 2.3  | 2.9         | 600   | 3.6   | 4.2         | 40   | 5                           | 1                      | -3.5  | 0           | 450   |
| BZX84C3V6LT1G           | Z15            | 3.4  | 3.6        | 3.8         | 90  | 2.7  | 3.3         | 600   | 3.9   | 4.5         | 40   | 5                           | 1                      | -3.5  | 0           | 450   |
| BZX84C3V9LT1G           | Z16            | 3.7  | 3.9        | 4.1         | 90  | 2.9  | 3.5         | 600   | 4.1   | 4.7         | 30   | 3                           | 1                      | -3.5  | -2.5        | 450   |
| BZX84C4V3LT1G           | W9             | 4  | 4.3        | 4.6         | 90  | 3.3  | 4           | 600   | 4.4   | 5.1         | 30   | 3                           | 1                      | -3.5  | 0           | 450   |
| <b>BZX84C4V7LT1/T3G</b> | <b>Z1</b>      | <b>4.4</b>   | <b>4.7</b> | <b>5</b>    | <b>80</b>   | <b>3.7</b>   | <b>4.7</b>  | <b>500</b>  | <b>4.5</b>  | <b>5.4</b>  | <b>15</b>  | <b>3</b>                    | <b>2</b>               | <b>-3.5</b>   | <b>0.2</b>  | <b>260</b>                                  |
| <b>BZX84C5V1LT1/T3G</b> | <b>Z2</b>      | <b>4.8</b>   | <b>5.1</b> | <b>5.4</b>  | <b>60</b>   | <b>4.2</b>   | <b>5.3</b>  | <b>480</b>  | <b>5</b>  | <b>5.9</b>  | <b>15</b>  | <b>2</b>                    | <b>2</b>               | <b>-2.7</b>   | <b>1.2</b>  | <b>225</b>                                  |
| <b>BZX84C5V6LT1/T3G</b> | <b>Z3</b>      | <b>5.2</b>   | <b>5.6</b> | <b>6</b>    | <b>40</b>   | <b>4.8</b>   | <b>6</b>    | <b>400</b>  | <b>5.2</b>  | <b>6.3</b>  | <b>10</b>  | <b>1</b>                    | <b>2</b>               | <b>-2.0</b>   | <b>2.5</b>  | <b>200</b>                                  |
| <b>BZX84C6V2LT1/T3G</b> | <b>Z4</b>      | <b>5.8</b>   | <b>6.2</b> | <b>6.6</b>  | <b>10</b>   | <b>5.6</b>   | <b>6.6</b>  | <b>150</b>  | <b>5.8</b>  | <b>6.8</b>  | <b>6</b>   | <b>3</b>                    | <b>4</b>               | <b>0.4</b>  | <b>3.7</b>  | <b>185</b>                                  |
| BZX84C6V8LT1/T3G        | Z5             | 6.4  | 6.8        | 7.2         | 15  | 6.3  | 7.2         | 80  | 6.4   | 7.4         | 6  | 2                           | 4                      | 1.2   | 4.5         | 155   |
| BZX84C7V5LT1G           | Z6             | 7  | 7.5        | 7.9         | 15  | 6.9  | 7.9         | 80  | 7   | 8           | 6  | 1                           | 5                      | 2.5   | 5.3         | 140   |
| BZX84C8V2LT1G           | Z7             | 7.7  | 8.2        | 8.7         | 15  | 7.6  | 8.7         | 80  | 7.7   | 8.8         | 6  | 0.7                         | 5                      | 3.2   | 6.2         | 135   |
| BZX84C9V1LT1/T3G        | Z8             | 8.5  | 9.1        | 9.6         | 15  | 8.4  | 9.6         | 100   | 8.5   | 9.7         | 8  | 0.5                         | 6                      | 3.8   | 7.0         | 130   |
| BZX84C10LT1G            | Z9             | 9.4  | 10         | 10.6        | 20  | 9.3  | 10.6        | 150   | 9.4   | 10.7        | 10   | 0.2                         | 7                      | 4.5   | 8.0         | 130   |
| BZX84C11LT1G            | Y1             | 10.4   | 11         | 11.6        | 20  | 10.2   | 11.6        | 150   | 10.4  | 11.8        | 10   | 0.1                         | 8                      | 5.4   | 9.0         | 130   |
| <b>BZX84C12LT1G</b>     | <b>Y2</b>      | <b>11.4</b>  | <b>12</b>  | <b>12.7</b> | <b>25</b>   | <b>11.2</b>  | <b>12.7</b> | <b>150</b>  | <b>11.4</b>   | <b>12.9</b> | <b>10</b>  | <b>0.1</b>                  | <b>8</b>               | <b>6.0</b>  | <b>10.0</b> | <b>130</b>                                  |
| BZX84C13LT1G            | Y3             | 12.4   | 13         | 14.1        | 30  | 12.3   | 14          | 170   | 12.5  | 14.2        | 15   | 0.1                         | 8                      | 7.0   | 11.0        | 120   |
| BZX84C15LT1/T3G         | Y4             | 13.8   | 15         | 15.6        | 30  | 13.7   | 15.5        | 200   | 13.9  | 15.7        | 20   | 0.05                        | 10.5                   | 9.2   | 13.0        | 110   |
| BZX84C16LT1G            | Y5             | 15.3   | 16         | 17.1        | 40  | 15.2   | 17          | 200   | 15.4  | 17.2        | 20   | 0.05                        | 11.2                   | 10.4  | 14.0        | 105   |
| <b>BZX84C18LT1/T3G</b>  | <b>Y6</b>      | <b>16.8</b>  | <b>18</b>  | <b>19.1</b> | <b>45</b>   | <b>16.7</b>  | <b>19</b>   | <b>225</b>  | <b>16.9</b>   | <b>19.2</b> | <b>20</b>  | <b>0.05</b>                 | <b>12.6</b>            | <b>12.4</b>   | <b>16.0</b> | <b>100</b>                                  |
| BZX84C20LT1G            | Y7             | 18.8   | 20         | 21.2        | 55  | 18.7   | 21.1        | 225   | 18.9  | 21.4        | 20   | 0.05                        | 14                     | 14.4  | 18.0        | 85  |
| BZX84C22LT1G            | Y8             | 20.8   | 22         | 23.3        | 55  | 20.7   | 23.2        | 250   | 20.9  | 23.4        | 25   | 0.05                        | 15.4                   | 16.4  | 20.0        | 85  |
| BZX84C24LT1G            | Y9             | 22.8   | 24         | 25.6        | 70  | 22.7   | 25.5        | 250   | 22.9  | 25.7        | 25   | 0.05                        | 16.8                   | 18.4  | 22.0        | 80  |
| Device*                 | Device Marking | V <sub>Z1</sub> Below<br>@ I <sub>ZT1</sub> = 2 mA               |            |             | Z <sub>ZT1</sub> Below<br>@ I <sub>ZT1</sub> = 2 mA | V <sub>Z2</sub> Below<br>@ I <sub>ZT2</sub> = 0.1 mA         |             | Z <sub>ZT2</sub> Below<br>@ I <sub>ZT2</sub> = 0.5 mA | V <sub>Z3</sub> Below<br>@ I <sub>ZT3</sub> = 10 mA           |             | Z <sub>ZT3</sub> Below<br>@ I <sub>ZT3</sub> = 10 mA | Max Reverse Leakage Current |                        | θ <sub>VZ</sub> (mV/k) Below<br>@ I <sub>ZT1</sub> = 2 mA |             | C (pF)<br>@ V <sub>R</sub> = 0<br>f = 1 MHz |
|                         |                | Min  | Nom        | Max         |   | Min  | Max         |   | Min   | Max         |  | I <sub>R</sub> (μA)         | V <sub>R</sub> (V)     | Min   | Max         |   |
| BZX84C27LT1G            | Y10            | 25.1   | 27         | 28.9        | 80  | 25   | 28.9        | 300   | 25.2  | 29.3        | 45   | 0.05                        | 18.9                   | 21.4  | 25.3        | 70  |
| BZX84C30LT1G            | Y11            | 28   | 30         | 32          | 80  | 27.8   | 32          | 300   | 28.1  | 32.4        | 50   | 0.05                        | 21                     | 24.4  | 29.4        | 70  |
| BZX84C33LT1/T3G         | Y12            | 31   | 33         | 35          | 80  | 30.8   | 35          | 325   | 31.1  | 35.4        | 55   | 0.05                        | 23.1                   | 27.4  | 33.4        | 70  |
| BZX84C36LT1G            | Y13            | 34   | 36         | 38          | 90  | 33.8   | 38          | 350   | 34.1  | 38.4        | 60   | 0.05                        | 25.2                   | 30.4  | 37.4        | 70  |
| BZX84C39LT1G            | Y14            | 37   | 39         | 41          | 130   | 36.7   | 41          | 350   | 37.1  | 41.5        | 70   | 0.05                        | 27.3                   | 33.4  | 41.2        | 45  |
| BZX84C43LT1G            | Y15            | 40   | 43         | 46          | 150   | 39.7   | 46          | 375   | 40.1  | 46.5        | 80   | 0.05                        | 30.1                   | 37.6  | 46.6        | 40  |
| BZX84C47LT1G            | Y16            | 44   | 47         | 50          | 170   | 43.7   | 50          | 375   | 44.1  | 50.5        | 90   | 0.05                        | 32.9                   | 42.0  | 51.8        | 40  |
| BZX84C51LT1G            | Y17            | 48   | 51         | 54          | 180   | 47.6   | 54          | 400   | 48.1  | 54.6        | 100  | 0.05                        | 35.7                   | 46.6  | 57.2        | 40  |
| BZX84C56LT1G            | Y18            | 52   | 56         | 60          | 200   | 51.5   | 60          | 425   | 52.1  | 60.8        | 110  | 0.05                        | 39.2                   | 52.2  | 63.8        | 40  |
| BZX84C62LT1G            | Y19            | 58   | 62         | 66          | 215   | 57.4   | 66          | 450   | 58.2  | 67          | 120  | 0.05                        | 43.4                   | 58.8  | 71.6        | 35  |
| BZX84C68LT1G            | Y20            | 64   | 68         | 72          | 240   | 63.4   | 72          | 475   | 64.2  | 73.2        | 130  | 0.05                        | 47.6                   | 65.6  | 79.8        | 35  |
| BZX84C75LT1G            | Y21            | 70   | 75         | 79          | 255   | 69.4   | 79          | 500   | 70.3  | 80.2        | 140  | 0.05                        | 52.5                   | 73.4  | 88.6        | 35  |

3. Zener voltage is measured with a pulse test current I<sub>Z</sub> at an ambient temperature of 25°C.

\*Includes SZ-prefix devices where applicable.

# BZX84BxxxLT1G, BZX84CxxxLT1G Series, SZBZX84BxxxLT1G, SZBZX84CxxxLT1G Series

## ELECTRICAL CHARACTERISTICS – BZX84BxxxL (Tight Tolerance Series)

(Pinout: 1-Anode, 2-No Connection, 3-Cathode) ( $T_A = 25^\circ\text{C}$  unless otherwise noted,  $V_F = 0.90\text{ V Max.}$  @  $I_F = 10\text{ mA}$ )

| Device             | Device Marking | $V_Z$ (Volts) @ $I_{ZT} = 5\text{ mA}$<br>(Note 4) |     |      | $Z_{ZT} (\Omega)$ @<br>$I_{ZT} = 5\text{ mA}$<br>(Note 4) | Max Reverse Leakage Current |         | $\theta_{VZ}$<br>(mV/k)<br>@ $I_{ZT} = 5\text{ mA}$ |     | C (pF)<br>@ $V_R = 0$ ,<br>f = 1 MHz |
|--------------------|----------------|--|-----|------|---|-----------------------------|---------|---|-----|--------------------------------------|
|                    |                |  |     |      |   | $I_R$                       | $V_R$   |   |     |                                      |
|                    |                | Min  | Nom | Max  | Max   | $\mu\text{A}$               | @ Volts | Min   | Max |                                      |
| BZX84B3V3LT1G      | T2A            | 3.23   | 3.3 | 3.37 | 95  | 5                           | 1       | -3.5  | 0   | 450                                  |
| BZX84B4V7LT1G      | T10            | 4.61   | 4.7 | 4.79 | 80  | 3                           | 2       | -3.5  | 0.2 | 260                                  |
| BZX84B5V1LT1G      | T11            | 5.00   | 5.1 | 5.20 | 60  | 2                           | 2       | -2.7  | 1.2 | 225                                  |
| BZX84B5V6LT1G      | T12            | 5.49   | 5.6 | 5.71 | 40  | 1                           | 2       | -2  | 2.5 | 200                                  |
| BZX84B6V2LT1G      | T13            | 6.08   | 6.2 | 6.32 | 10  | 3                           | 4       | 0.4   | 3.7 | 185                                  |
| BZX84B6V8LT1G      | T14            | 6.66   | 6.8 | 6.94 | 15  | 2                           | 4       | 1.2   | 4.5 | 155                                  |
| BZX84B7V5LT1G      | T15            | 7.35   | 7.5 | 7.65 | 15  | 1                           | 5       | 2.5   | 5.3 | 140                                  |
| BZX84B8V2LT1G      | T16            | 8.04   | 8.2 | 8.36 | 15  | 0.7                         | 5       | 3.2   | 6.2 | 135                                  |
| BZX84B9V1LT1G, T3G | T17            | 8.92   | 9.1 | 9.28 | 15  | 0.5                         | 6       | 3.8   | 7   | 130                                  |
| BZX84B10LT1G       | T2E            | 9.8  | 10  | 10.2 | 20  | 0.2                         | 7       | 4.5   | 8   | 130                                  |
| BZX84B12LT1G       | T18            | 11.8   | 12  | 12.2 | 25  | 0.1                         | 8       | 6   | 10  | 130                                  |
| BZX84B15LT1G       | T22            | 14.7   | 15  | 15.3 | 30  | 0.05                        | 10.5    | 9.2   | 13  | 110                                  |
| BZX84B16LT1G       | T19            | 15.7   | 16  | 16.3 | 40  | 0.05                        | 11.2    | 10.4  | 14  | 105                                  |
| BZX84B18LT1G       | T20            | 17.6   | 18  | 18.4 | 45  | 0.05                        | 12.6    | 12.4  | 16  | 100                                  |
| BZX84B22LT1G       | T24            | 21.6   | 22  | 22.4 | 55  | 0.05                        | 15.4    | 16.4  | 20  | 85                                   |
| BZX84B24LT1G       | T25            | 23.5   | 24  | 24.5 | 70  | 0.05                        | 16.8    | 18.4  | 22  | 80                                   |

4. Zener voltage is measured with a pulse test current  $I_Z$  at an ambient temperature of  $25^\circ\text{C}$ .

## ELECTRICAL CHARACTERISTICS – BZX84BxxxL (Tight Tolerance Series)

(Pinout: 1-Anode, 2-No Connection, 3-Cathode) ( $T_A = 25^\circ\text{C}$  unless otherwise noted,  $V_F = 0.90\text{ V Max.}$  @  $I_F = 10\text{ mA}$ )

| Device*      | Device Marking | $V_Z$ (Volts) @ $I_{ZT} = 2\text{ mA}$<br>(Note 4) |     |      | $Z_{ZT} (\Omega)$ @<br>$I_{ZT} = 2\text{ mA}$<br>(Note 4) | Max Reverse Leakage Current |         | $\theta_{VZ}$<br>(mV/k)<br>@ $I_{ZT} = 2\text{ mA}$ |      | C (pF)<br>@ $V_R = 0$ ,<br>f = 1 MHz |
|--------------|----------------|--|-----|------|---|-----------------------------|---------|---|------|--------------------------------------|
|              |                |  |     |      |   | $I_R$                       | $V_R$   |   |      |                                      |
|              |                | Min  | Nom | Max  | Max   | $\mu\text{A}$               | @ Volts | Min   | Max  |                                      |
| BZX84B27LT1G | T27            | 26.5   | 27  | 27.5 | 80  | 0.05                        | 18.9    | 21.4  | 25.3 | 70                                   |

\*Includes SZ-prefix devices where applicable.

# BZX84BxxxLT1G, BZX84CxxxLT1G Series, SZBZX84BxxxLT1G, SZBZX84CxxxLT1G Series

## TYPICAL CHARACTERISTICS

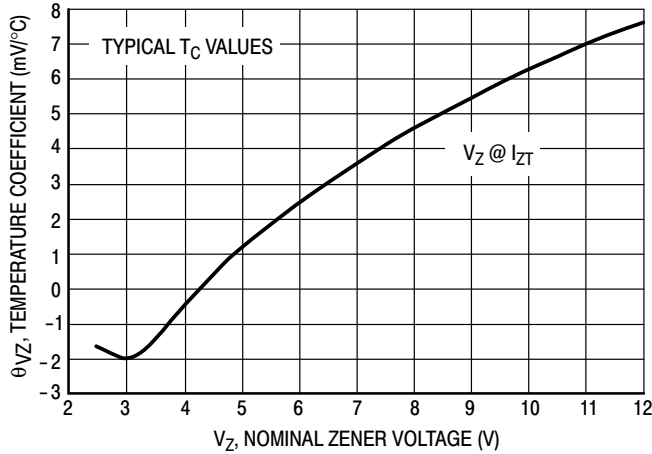

**Figure 1. Temperature Coefficients  
(Temperature Range -55°C to +150°C)**

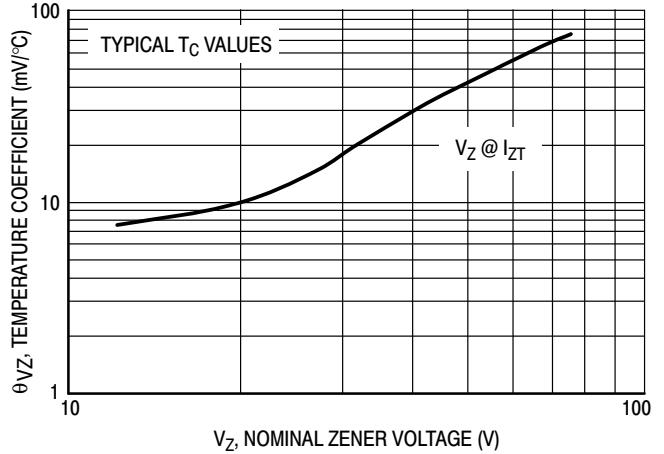

**Figure 2. Temperature Coefficients  
(Temperature Range -55°C to +150°C)**

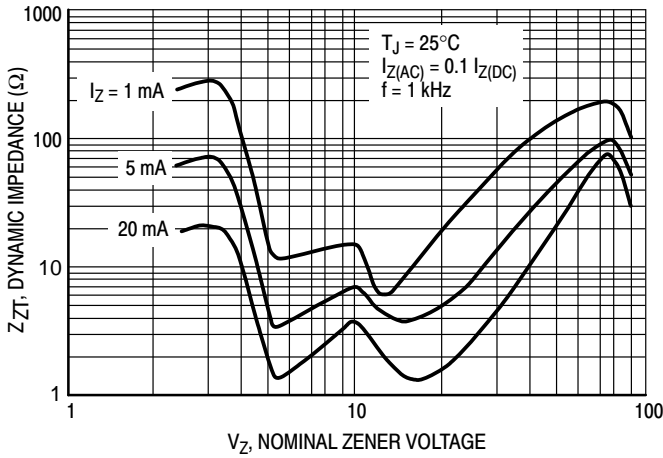

**Figure 3. Effect of Zener Voltage on  
Zener Impedance**



**Figure 4. Typical Forward Voltage**

**BZX84BxxxLT1G, BZX84CxxxLT1G Series, SZBZX84BxxxLT1G, SZBZX84CxxxLT1G Series**

**TYPICAL CHARACTERISTICS**



**Figure 5. Typical Capacitance**



**Figure 6. Typical Leakage Current**



**Figure 7. Zener Voltage versus Zener Current  
(V<sub>Z</sub> Up to 12 V)**



**Figure 8. Zener Voltage versus Zener Current  
(12 V to 91 V)**

# BZX84BxxxLT1G, BZX84CxxxLT1G Series, SZBZX84BxxxLT1G, SZBZX84CxxxLT1G Series

## PACKAGE DIMENSIONS

SOT-23 (TO-236)

CASE 318-08

ISSUE AR

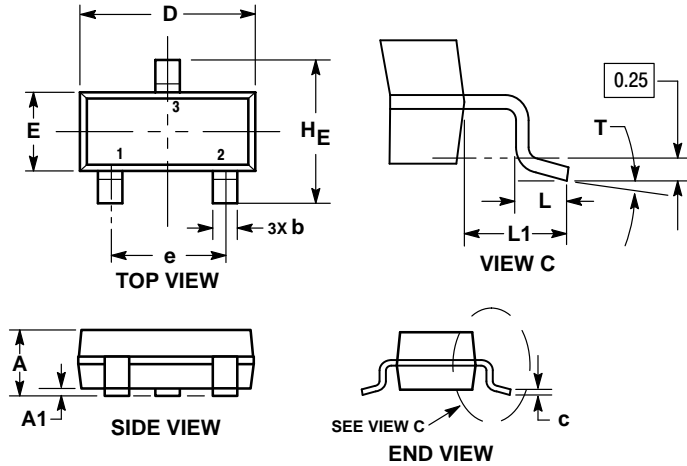

NOTES:

1. DIMENSIONING AND TOLERANCING PER ASME Y14.5M, 1994.
2. CONTROLLING DIMENSION: MILLIMETERS.
3. MAXIMUM LEAD THICKNESS INCLUDES LEAD FINISH. MINIMUM LEAD THICKNESS IS THE MINIMUM THICKNESS OF THE BASE MATERIAL.
4. DIMENSIONS D AND E DO NOT INCLUDE MOLD FLASH, PROTRUSIONS, OR GATE BURRS.

| DIM | MILLIMETERS |      |      | INCHES |       |       |
|-----|-------------|------|------|--------|-------|-------|
|     | MIN         | NOM  | MAX  | MIN    | NOM   | MAX   |
| A   | 0.89        | 1.00 | 1.11 | 0.035  | 0.039 | 0.044 |
| A1  | 0.01        | 0.06 | 0.10 | 0.000  | 0.002 | 0.004 |
| b   | 0.37        | 0.44 | 0.50 | 0.015  | 0.017 | 0.020 |
| c   | 0.08        | 0.14 | 0.20 | 0.003  | 0.006 | 0.008 |
| D   | 2.80        | 2.90 | 3.04 | 0.110  | 0.114 | 0.120 |
| E   | 1.20        | 1.30 | 1.40 | 0.047  | 0.051 | 0.055 |
| e   | 1.78        | 1.90 | 2.04 | 0.070  | 0.075 | 0.080 |
| L   | 0.30        | 0.43 | 0.55 | 0.012  | 0.017 | 0.022 |
| L1  | 0.35        | 0.54 | 0.69 | 0.014  | 0.021 | 0.027 |
| HE  | 2.10        | 2.40 | 2.64 | 0.083  | 0.094 | 0.104 |
| T   | 0°          | ---  | 10°  | 0°     | ---   | 10°   |

STYLE 8:

1. ANODE
2. NO CONNECTION
3. CATHODE

### RECOMMENDED SOLDERING FOOTPRINT

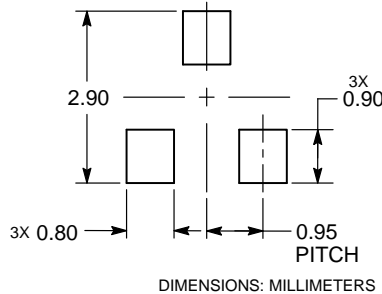

ON Semiconductor and are trademarks of Semiconductor Components Industries, LLC dba ON Semiconductor or its subsidiaries in the United States and/or other countries. ON Semiconductor owns the rights to a number of patents, trademarks, copyrights, trade secrets, and other intellectual property. A listing of ON Semiconductor's product/patent coverage may be accessed at [www.onsemi.com/site/pdf/Patent-Marking.pdf](http://www.onsemi.com/site/pdf/Patent-Marking.pdf). ON Semiconductor reserves the right to make changes without further notice to any products herein. ON Semiconductor makes no warranty, representation or guarantee regarding the suitability of its products for any particular purpose, nor does ON Semiconductor assume any liability arising out of the application or use of any product or circuit, and specifically disclaims any and all liability, including without limitation special, consequential or incidental damages. Buyer is responsible for its products and applications using ON Semiconductor products, including compliance with all laws, regulations and safety requirements or standards, regardless of any support or applications information provided by ON Semiconductor. "Typical" parameters which may be provided in ON Semiconductor data sheets and/or specifications can and do vary in different applications and actual performance may vary over time. All operating parameters, including "Typicals" must be validated for each customer application by customer's technical experts. ON Semiconductor does not convey any license under its patent rights nor the rights of others. ON Semiconductor products are not designed, intended, or authorized for use as a critical component in life support systems or any FDA Class 3 medical devices or medical devices with a same or similar classification in a foreign jurisdiction or any devices intended for implantation in the human body. Should Buyer purchase or use ON Semiconductor products for any such unintended or unauthorized application, Buyer shall indemnify and hold ON Semiconductor and its officers, employees, subsidiaries, affiliates, and distributors harmless against all claims, costs, damages, and expenses, and reasonable attorney fees arising out of, directly or indirectly, any claim of personal injury or death associated with such unintended or unauthorized use, even if such claim alleges that ON Semiconductor was negligent regarding the design or manufacture of the part. ON Semiconductor is an Equal Opportunity/Affirmative Action Employer. This literature is subject to all applicable copyright laws and is not for resale in any manner.

### PUBLICATION ORDERING INFORMATION

LITERATURE FULFILLMENT:

Literature Distribution Center for ON Semiconductor  
 P.O. Box 5163, Denver, Colorado 80217 USA  
 Phone: 303-675-2175 or 800-344-3860 Toll Free USA/Canada  
 Fax: 303-675-2176 or 800-344-3867 Toll Free USA/Canada  
 Email: [orderlit@onsemi.com](mailto:orderlit@onsemi.com)

**N. American Technical Support:** 800-282-9855 Toll Free  
 USA/Canada  
**Europe, Middle East and Africa Technical Support:**  
 Phone: 421 33 790 2910  
**Japan Customer Focus Center**  
 Phone: 81-3-5817-1050

**ON Semiconductor Website:** [www.onsemi.com](http://www.onsemi.com)

**Order Literature:** <http://www.onsemi.com/orderlit>

For additional information, please contact your local Sales Representative

## X-ON Electronics

Largest Supplier of Electrical and Electronic Components

*Click to view similar products for [Zener Diodes](#) category:*

*Click to view products by [ON Semiconductor](#) manufacturer:*

Other Similar products are found below :

[MMSZ5245BS-7-F](#) [RKZ13B2KG#P1](#) [RKZ5.6B2KJ#R1](#) [EDZTE6113B](#) [EDZTE6116B](#) [EDZTE616.8B](#) [1N747A](#) [1N966B](#) [NTE5116A](#)  
[NTE5121A](#) [NTE5139A](#) [NTE5147A](#) [NTE5152A](#) [NTE5155A](#) [NTE5156A](#) [NTE5164A](#) [JANS1N4974US](#) [SMAJ4764A-TP](#) [RKZ5.1BKU#P6](#)  
[3SMAJ5946B-TP](#) [3SMAJ5950B-TP](#) [3SMBJ5920B-TP](#) [3SMBJ5925B-TP](#) [TDZTR24](#) [441774C](#) [MMSZ4678-TP](#) [MMSZ5232BQ-13-F](#)  
[BZG04-36](#) [BZG05C9V1-HE3-TR](#) [HZM30NBTR-E](#) [UDZTE-175.1B](#) [3SMAJ5945B-TP](#) [3SMAJ5947B-TP](#) [3SMBJ5941B-TP](#) [DL4746A-TP](#)  
[RKZ18B2KK#R1](#) [RKZ10B2KL#R1](#) [RKZ6.8B2KL#R1](#) [RKZ8.2B2KL#R1](#) [DZ2S240M0L](#) [SMAZ27-TP](#) [SMBZ5920B-E3/52](#) [ZMM3.0](#)  
[RD16UM-T1-A](#) [RD39S-T1-A](#) [RD9.1S-T1-A](#) [RD10S-T1-A](#) [RD20S-T1-A](#) [RD2.2S-T1-A](#) [RD2.7UM-T1-A](#)