

# FOD814 Series, FOD617 Series, FOD817 Series 4-Pin High Operating Temperature Phototransistor Optocouplers

## Features

- AC input response (FOD814 only)
- Applicable to Pb-free IR reflow soldering
- Compact 4-pin package
- Current transfer ratio in selected groups:
 

|                   |                   |
|-------------------|-------------------|
| FOD617A: 40–80%   | FOD817: 50–600%   |
| FOD617B: 63–125%  | FOD817A: 80–160%  |
| FOD617C: 100–200% | FOD817B: 130–260% |
| FOD617D: 160–320% | FOD817C: 200–400% |
| FOD814: 20–300%   | FOD817D: 300–600% |
| FOD814A: 50–150%  |                   |
- C-UL, UL and VDE approved
- High input-output isolation voltage of 5000Vrms
- Minimum  $BV_{CEO}$  of 70V guaranteed
- Higher operating temperatures (versus H11AXXX counterparts)

## Applications

### FOD814 Series

- AC line monitor
- Unknown polarity DC sensor
- Telephone line interface

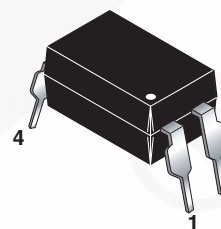
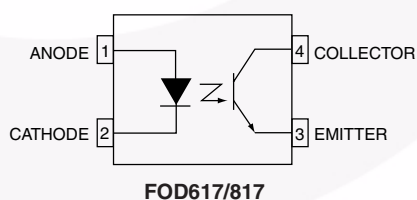
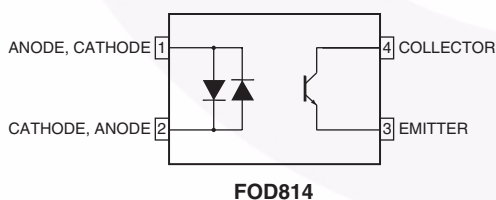
### FOD617 and FOD817 Series

- Power supply regulators
- Digital logic inputs
- Microprocessor inputs

## Description

The FOD814 consists of two gallium arsenide infrared emitting diodes, connected in inverse parallel, driving a silicon phototransistor output in a 4-pin dual in-line package. The FOD617/817 Series consists of a gallium arsenide infrared emitting diode driving a silicon phototransistor in a 4-pin dual in-line package.

## Functional Block Diagram



**Absolute Maximum Ratings** ( $T_A = 25^\circ\text{C}$  Unless otherwise specified.)

Stresses exceeding the absolute maximum ratings may damage the device. The device may not function or be operable above the recommended operating conditions and stressing the parts to these levels is not recommended. In addition, extended exposure to stresses above the recommended operating conditions may affect device reliability. The absolute maximum ratings are stress ratings only.

| Symbol              | Parameter  | Value          |                          | Units                |
|---------------------|--|----------------|--------------------------|----------------------|
|                     |  | FOD814         | FOD617/817               |                      |
| <b>TOTAL DEVICE</b> |  |                |                          |                      |
| $T_{STG}$           | Storage Temperature  | -55 to +150    |                          | $^\circ\text{C}$     |
| $T_{OPR}$           | Operating Temperature  | -55 to +105    | -55 to +110              | $^\circ\text{C}$     |
| $T_{SOL}$           | Lead Solder Temperature  | 260 for 10 sec |                          | $^\circ\text{C}$     |
| $P_{TOT}$           | Total Power Dissipation  | 200            |                          | mW                   |
| <b>EMITTER</b>      |  |                |                          |                      |
| $I_F$               | Continuous Forward Current                                     | $\pm 50$       | 50                       | mA                   |
| $V_R$               | Reverse Voltage  |                | 6                        |                      |
| $P_D$               | Power Dissipation<br>Derate above $100^\circ\text{C}$          | 70             |                          | mW                   |
|                     |  | 1.7            |                          | mW/ $^\circ\text{C}$ |
| <b>DETECTOR</b>     |  |                |                          |                      |
| $V_{CEO}$           | Collector-Emitter Voltage                                      | 70             |                          | V                    |
| $V_{ECO}$           | Emitter-Collector Voltage                                      | 6              | 6 (FOD817)<br>7 (FOD617) | V                    |
| $I_C$               | Continuous Collector Current                                   | 50             |                          | mA                   |
| $P_C$               | Collector Power Dissipation<br>Derate above $90^\circ\text{C}$ | 150            |                          | mW                   |
|                     |  | 2.9            |                          | mW/ $^\circ\text{C}$ |

**Electrical Characteristics** ( $T_A = 25^\circ\text{C}$  Unless otherwise specified.)

**Individual Component Characteristics**

| Symbol          | Parameter                           | Device    | Test Conditions                 | Min. | Typ.* | Max. | Unit          |
|-----------------|-------------------------------------|-----------|---------------------------------|------|-------|------|---------------|
| <b>EMITTER</b>  |                                     |           |                                 |      |       |      |               |
| $V_F$           | Forward Voltage                     | FOD814    | $I_F = \pm 20\text{mA}$         |      | 1.2   | 1.4  | V             |
|                 |                                     | FOD617    | $I_F = 60\text{mA}$             |      | 1.35  | 1.65 |               |
|                 |                                     | FOD817    | $I_F = 20\text{mA}$             |      | 1.2   | 1.4  |               |
| $I_R$           | Reverse Leakage Current             | FOD617    | $V_R = 6.0\text{V}$             |      | 0.001 | 10   | $\mu\text{A}$ |
|                 |                                     | FOD817    | $V_R = 4.0\text{V}$             |      |       | 10   |               |
| $C_t$           | Terminal Capacitance                | FOD814    | $V = 0, f = 1\text{kHz}$        |      | 50    | 250  | pF            |
|                 |                                     | FOD617    | $V = 0, f = 1\text{kHz}$        |      | 30    | 250  |               |
|                 |                                     | FOD817    | $V = 0, f = 1\text{kHz}$        |      | 30    | 250  |               |
| <b>DETECTOR</b> |                                     |           |                                 |      |       |      |               |
| $I_{CEO}$       | Collector Dark Current              | FOD814    | $V_{CE} = 20\text{V}, I_F = 0$  |      |       | 100  | nA            |
|                 |                                     | FOD617C/D | $V_{CE} = 10\text{V}, I_F = 0$  |      | 1     | 100  |               |
|                 |                                     | FOD617A/B | $V_{CE} = 10\text{V}, I_F = 0$  |      | 1     | 50   |               |
|                 |                                     | FOD817    | $V_{CE} = 20\text{V}, I_F = 0$  |      |       | 100  |               |
| $BV_{CEO}$      | Collector-Emitter Breakdown Voltage | FOD814    | $I_C = 0.1\text{mA}, I_F = 0$   | 70   |       |      | V             |
|                 |                                     | FOD617    | $I_C = 100\mu\text{A}, I_F = 0$ | 70   |       |      |               |
|                 |                                     | FOD817    | $I_C = 0.1\text{mA}, I_F = 0$   | 70   |       |      |               |
| $BV_{ECO}$      | Emitter-Collector Breakdown Voltage | FOD814    | $I_E = 10\mu\text{A}, I_F = 0$  | 6    |       |      | V             |
|                 |                                     | FOD617    | $I_E = 10\mu\text{A}, I_F = 0$  | 7    |       |      |               |
|                 |                                     | FOD817    | $I_E = 10\mu\text{A}, I_F = 0$  | 6    |       |      |               |

**Transfer Characteristics**

| Symbol        | DC Characteristic                    | Device  | Test Conditions                                  | Min. | Typ.* | Max. | Unit |
|---------------|--------------------------------------|---------|--|------|-------|------|------|
| CTR           | Current Transfer Ratio               | FOD814  | $I_F = \pm 1\text{mA}, V_{CE} = 5\text{V}^{(1)}$ | 20   |       | 300  | %    |
|               |                                      | FOD814A |  | 50   |       | 150  |      |
|               |                                      | FOD617A | $I_F = 10\text{mA}, V_{CE} = 5\text{V}^{(1)}$    | 40   |       | 80   |      |
|               |                                      | FOD617B |  | 63   |       | 125  |      |
|               |                                      | FOD617C |  | 100  |       | 200  |      |
|               |                                      | FOD617D | 160  |      | 320   |      |      |
|               |                                      | FOD617A | $I_F = 1\text{mA}, V_{CE} = 5\text{V}^{(1)}$     | 13   |       |      |      |
|               |                                      | FOD617B |  | 22   |       |      |      |
|               |                                      | FOD617C |  | 34   |       |      |      |
|               |                                      | FOD617D | 56   |      |       |      |      |
|               |                                      | FOD817  | $I_F = 5\text{mA}, V_{CE} = 5\text{V}^{(1)}$     | 50   |       | 600  |      |
|               |                                      | FOD817A |  | 80   |       | 160  |      |
|               |                                      | FOD817B |  | 130  |       | 260  |      |
|               |                                      | FOD817C |  | 200  |       | 400  |      |
|               |                                      | FOD817D |  | 300  |       | 600  |      |
| $V_{CE(sat)}$ | Collector-Emitter Saturation Voltage | FOD814  | $I_F = \pm 20\text{mA}, I_C = 1\text{mA}$        |      | 0.1   | 0.2  | V    |
|               |                                      | FOD617  | $I_F = 10\text{mA}, I_C = 2.5\text{mA}$          |      |       | 0.4  |      |
|               |                                      | FOD817  | $I_F = 20\text{mA}, I_C = 1\text{mA}$            |      | 0.1   | 0.2  |      |

\*Typical values at  $T_A = 25^\circ\text{C}$

**Electrical Characteristics** ( $T_A = 25^\circ\text{C}$  Unless otherwise specified.) (Continued)

**Transfer Characteristics** (Continued)

| Symbol | AC Characteristic    | Device | Test Conditions   | Min. | Typ.* | Max. | Unit          |
|--------|----------------------|--------|---|------|-------|------|---------------|
| $f_C$  | Cut-Off Frequency    | FOD814 | $V_{CE} = 5\text{V}$ , $I_C = 2\text{mA}$ , $R_L = 100\Omega$ ,<br>-3dB | 15   | 80    |      | kHz           |
| $t_r$  | Response Time (Rise) | FOD814 | $V_{CE} = 2\text{V}$ , $I_C = 2\text{mA}$ , $R_L = 100\Omega^{(2)}$     |      | 4     | 18   | $\mu\text{s}$ |
|        |                      | FOD617 |   |      |       |      |               |
|        |                      | FOD817 |   |      |       |      |               |
| $t_f$  | Response Time (Fall) | FOD814 |   |      | 3     | 18   | $\mu\text{s}$ |
|        |                      | FOD617 |   |      |       |      |               |
|        |                      | FOD817 |   |      |       |      |               |

**Isolation Characteristics**

| Symbol    | Characteristic                                | Device | Test Conditions   | Min.               | Typ.*              | Max. | Units    |
|-----------|---|--------|---|--------------------|--------------------|------|----------|
| $V_{ISO}$ | Input-Output Isolation Voltage <sup>(3)</sup> | FOD814 | $f = 60\text{Hz}$ , $t = 1\text{ min}$ ,<br>$I_{I-O} \leq 2\mu\text{A}$ | 5000               |                    |      | Vac(rms) |
|           |   | FOD617 |   |                    |                    |      |          |
|           |   | FOD817 |   |                    |                    |      |          |
| $R_{ISO}$ | Isolation Resistance                          | FOD814 | $V_{I-O} = 500\text{VDC}$   | $5 \times 10^{10}$ | $1 \times 10^{11}$ |      | $\Omega$ |
|           |   | FOD617 |   |                    |                    |      |          |
|           |   | FOD817 |   |                    |                    |      |          |
| $C_{ISO}$ | Isolation Capacitance                         | FOD814 | $V_{I-O} = 0$ , $f = 1\text{ MHz}$                                      |                    | 0.6                | 1.0  | pf       |
|           |   | FOD617 |   |                    |                    |      |          |
|           |   | FOD817 |   |                    |                    |      |          |

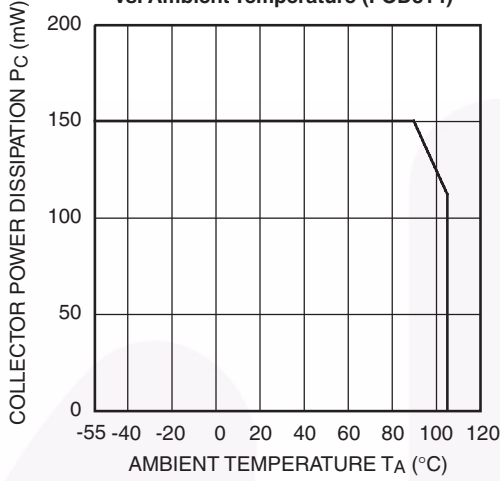
\*Typical values at  $T_A = 25^\circ\text{C}$

**Notes:**

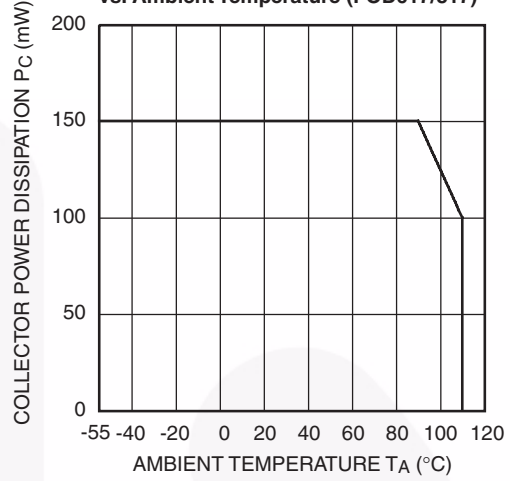
1. Current Transfer Ratio (CTR) =  $I_C/I_F \times 100\%$ .
2. For test circuit setup and waveforms, refer to page 4.
3. For this test, Pins 1 and 2 are common, and Pins 3 and 4 are common.

**Typical Electrical/Optical Characteristics** ( $T_A = 25^\circ\text{C}$  Unless otherwise specified.)

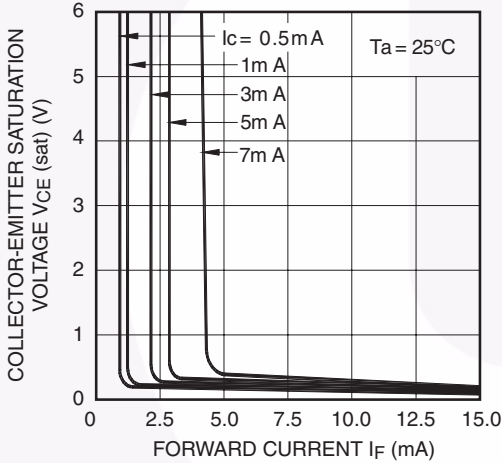
**Fig. 1 Collector Power Dissipation vs. Ambient Temperature (FOD814)**



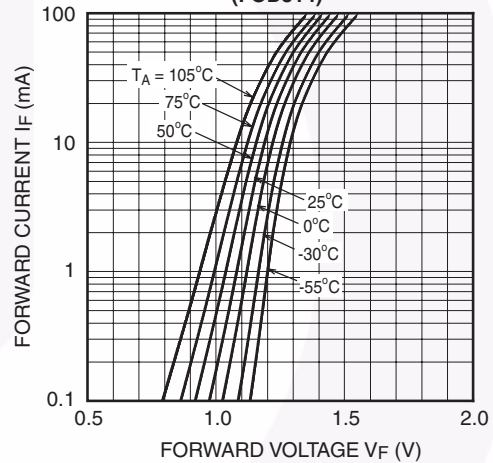
**Fig. 2 Collector Power Dissipation vs. Ambient Temperature (FOD617/817)**



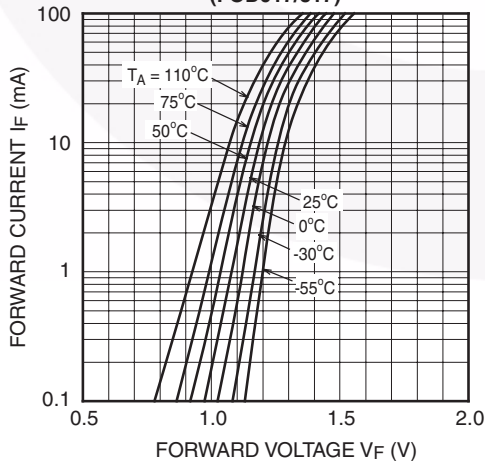
**Fig. 3 Collector-Emitter Saturation Voltage vs. Forward Current**



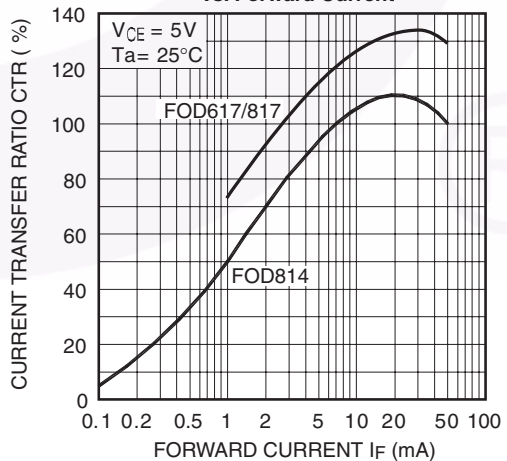
**Fig. 4 Forward Current vs. Forward Voltage (FOD814)**



**Fig. 5 Forward Current vs. Forward Voltage (FOD617/817)**

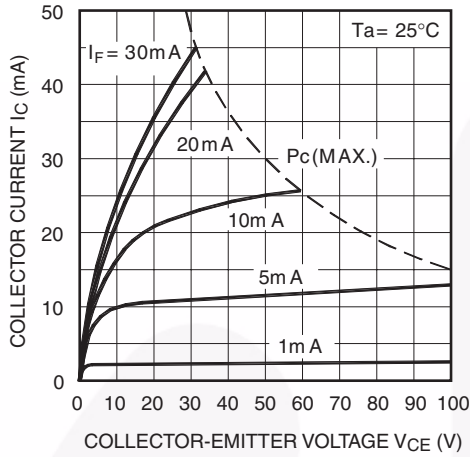


**Fig. 6 Current Transfer Ratio vs. Forward Current**

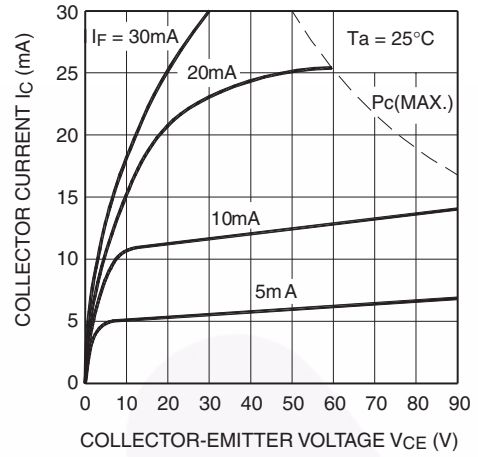


**Typical Electrical/Optical Characteristics** (Continued) ( $T_A = 25^\circ\text{C}$  Unless otherwise specified.)

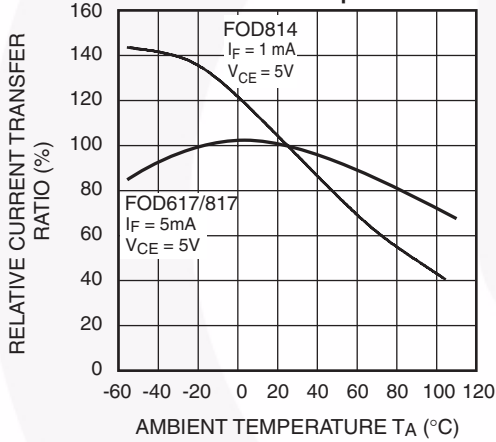
**Fig. 7 Collector Current vs. Collector-Emitter Voltage (FOD814)**



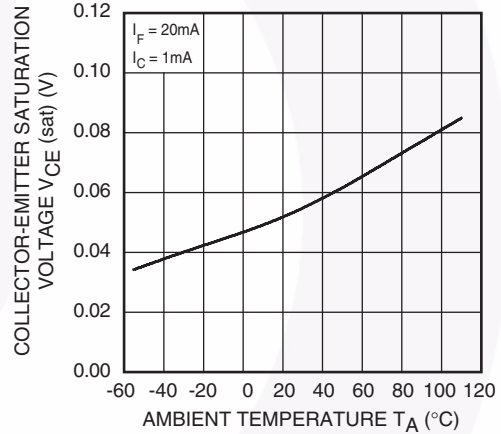
**Fig. 8 Collector Current vs. Collector-Emitter Voltage (FOD617/817)**



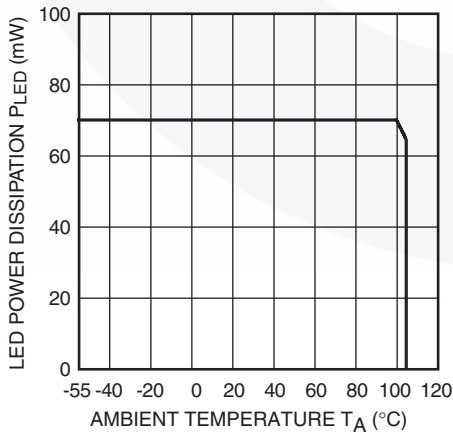
**Fig. 9 Relative Current Transfer Ratio vs. Ambient Temperature**



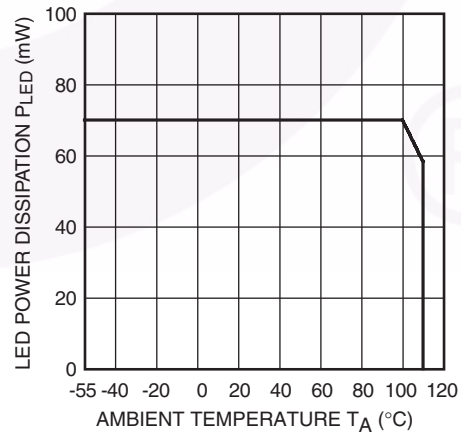
**Fig. 10 Collector-Emitter Saturation Voltage vs. Ambient Temperature**



**Fig. 11 LED Power Dissipation vs. Ambient Temperature (FOD814)**

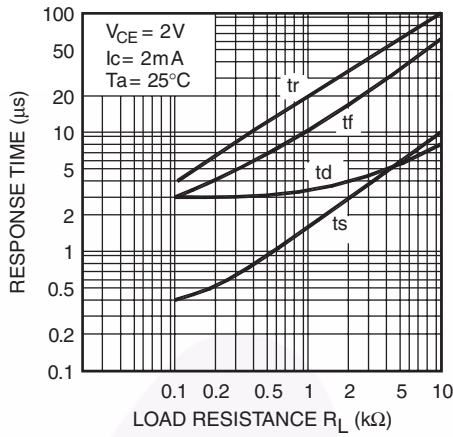


**Fig. 12 LED Power Dissipation vs. Ambient Temperature (FOD617/817)**

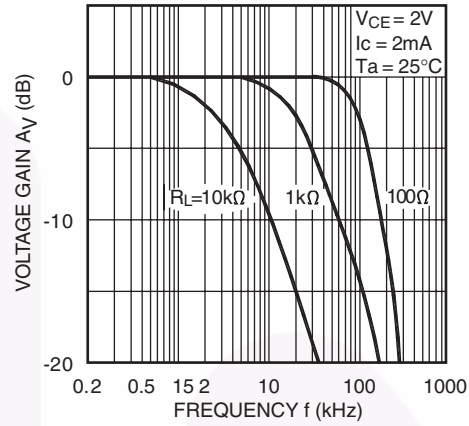


**Typical Electrical/Optical Characteristics** (Continued) ( $T_A = 25^\circ\text{C}$  Unless otherwise specified.)

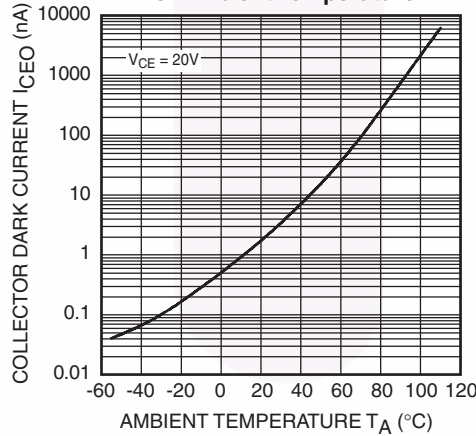
**Fig. 13 Response Time vs. Load Resistance**



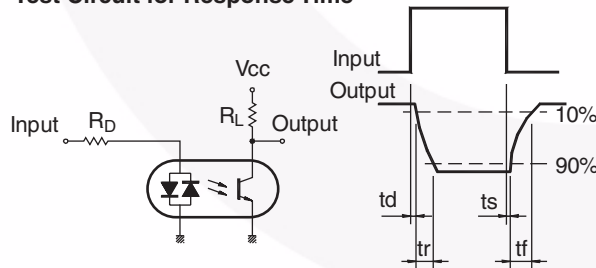
**Fig. 14 Frequency Response**



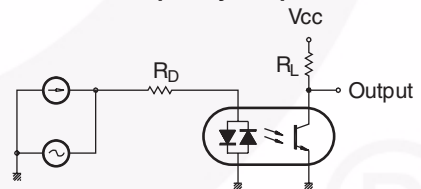
**Fig. 15 Collector Dark Current vs. Ambient Temperature**



**Test Circuit for Response Time**

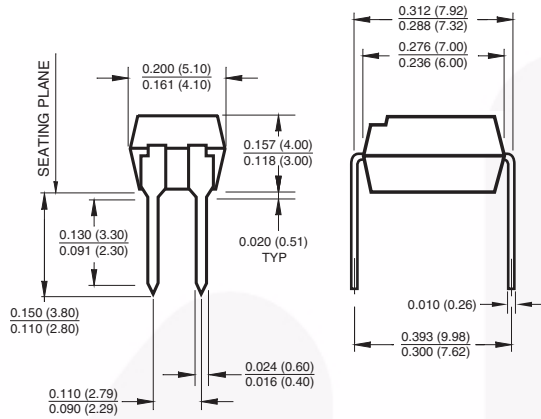


**Test Circuit for Frequency Response**

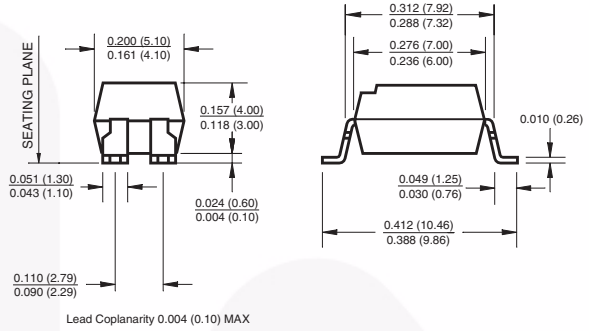


## Package Dimensions

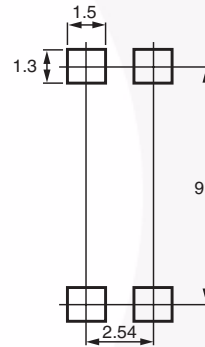
### Through Hole



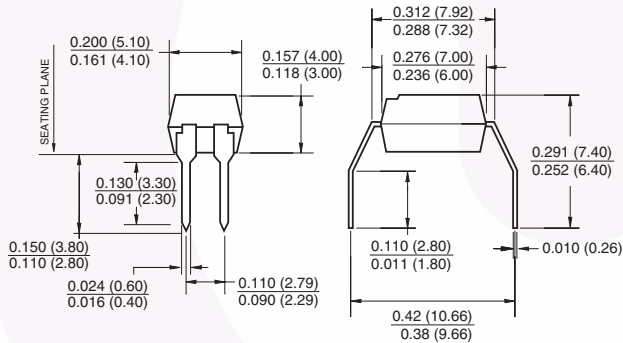
### Surface Mount



### Surface Mount (Footprint Dimensions)



### 0.4" Lead Spacing



#### Note:

All dimensions are in inches (millimeters)

Package drawings are provided as a service to customers considering Fairchild components. Drawings may change in any manner without notice. Please note the revision and/or date on the drawing and contact a Fairchild Semiconductor representative to verify or obtain the most recent revision. Package specifications do not expand the terms of Fairchild's worldwide terms and conditions, specifically the warranty therein, which covers Fairchild products.

Always visit Fairchild Semiconductor's online packaging area for the most recent package drawings:

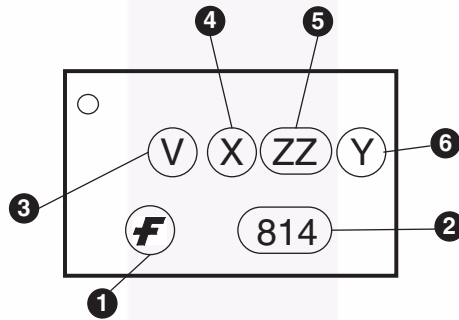
<http://www.fairchildsemi.com/packaging/>



### Ordering Information

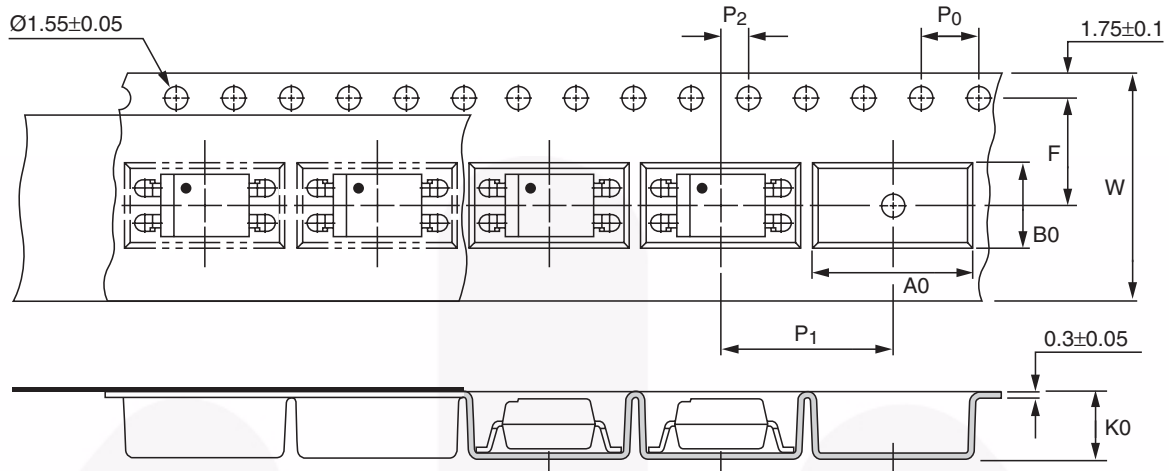
| Option | Part Number Example | Description                              |
|--------|---------------------|--|
| S      | FOD814S             | Surface Mount Lead Bend                  |
| SD     | FOD814SD            | Surface Mount; Tape and reel             |
| W      | FOD814W             | 0.4" Lead Spacing                        |
| 300    | FOD814300           | VDE Approved                             |
| 300W   | FOD814300W          | VDE Approved, 0.4" Lead Spacing          |
| 3S     | FOD8143S            | VDE Approved, Surface Mount              |
| 3SD    | FOD8143SD           | VDE Approved, Surface Mount, Tape & Reel |

### Marking Information



| Definitions |  |
|-------------|--|
| 1           | Fairchild logo   |
| 2           | Device number  |
| 3           | VDE mark (Note: Only appears on parts ordered with VDE option – See order entry table) |
| 4           | One digit year code  |
| 5           | Two digit work week ranging from '01' to '53'  |
| 6           | Assembly package code  |

### Carrier Tape Specifications

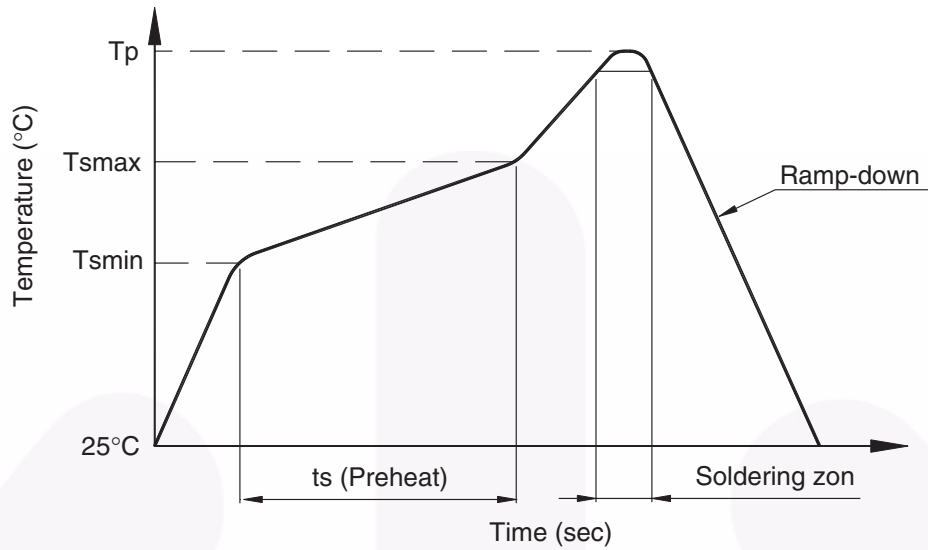


**Note:**

All dimensions are in millimeters.

| Symbol     | Description                            | Dimensions in mm (inches)                  |
|------------|--|--|
| W          | Tape wide                              | $16 \pm 0.3$ (.63)                         |
| $P_0$      | Pitch of sprocket holes                | $4 \pm 0.1$ (.15)                          |
| F<br>$P_2$ | Distance of compartment                | $7.5 \pm 0.1$ (.295)<br>$2 \pm 0.1$ (.079) |
| $P_1$      | Distance of compartment to compartment | $12 \pm 0.1$ (.472)                        |
| $A_0$      | Compartment                            | $10.45 \pm 0.1$ (.411)                     |
| $B_0$      |  | $5.30 \pm 0.1$ (.209)                      |
| $K_0$      |  | $4.25 \pm 0.1$ (.167)                      |

### Lead Free Recommended IR Reflow Condition



| Profile Feature  | Pb-Sn solder assembly         | Lead Free assembly            |
|--|-------------------------------|-------------------------------|
| Preheat condition<br>( $T_{smin}$ - $T_{smax}$ / $t_s$ ) | 100°C ~ 150°C<br>60 ~ 120 sec | 150°C ~ 200°C<br>60 ~ 120 sec |
| Melt soldering zone                                      | 183°C<br>60 ~ 120 sec         | 217°C<br>30 ~ 90 sec          |
| Peak temperature ( $T_p$ )                               | 240 +0/-5°C                   | 260 +0/-5°C                   |
| Ramp-down rate   | 6°C/sec max.                  | 6°C/sec max.                  |






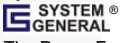
### Recommended Wave Soldering condition

| Profile Feature            | For all solder assembly |
|----------------------------|-------------------------|
| Peak temperature ( $T_p$ ) | Max 260°C for 10 sec    |



### TRADEMARKS

The following includes registered and unregistered trademarks and service marks, owned by Fairchild Semiconductor and/or its global subsidiaries, and is not intended to be an exhaustive list of all such trademarks.

|   |   |   |   |
|---|---|---|---|
| Build it Now™   | FRFET®  | Programmable Active Droop™  | the power franchise   |
| CorePLUS™   | Global Power Resource SM  | QFET®   | TinyBoost™  |
| CorePOWER™  | Green FPS™  | QS™   | TinyBuck™   |
| CROSSVOLT™  | Green FPS™ e-Series™  | Quiet Series™   | TinyLogic®  |
| CTL™  | GTO™  | RapidConfigure™   | TINYOPTO™   |
| Current Transfer Logic™   | IntelliMAX™   |  ™ | TinyPower™  |
| EcoSPARK®   | ISOPLANAR™  | Saving our world, 1mW/W/kW at a time™   | TinyPWM™  |
| EfficientMax™   | MegaBuck™   | SmartMax™   | TinyWire™   |
| EZSWITCH™ *   | MICROCOUPLER™   | SMART START™  | µSerDes™  |
|  ™ | MicroFET™   | SPM®  |  ™ |
|  ™ | MicroPak™   | STEALTH™  | UHC®  |
| Fairchild®  | MillerDrive™  | SuperFET™   | Ultra FRFET™  |
| Fairchild Semiconductor®  | MotionMax™  | SuperSOT™3  | UniFET™   |
| FACT Quiet Series™  | Motion-SPM™   | SuperSOT™6  | VCX™  |
| FACT®   | OPTOLOGIC®  | SuperSOT™8  | VisualMax™  |
| FAST®   | OPTOPLANAR®   | SupreMOS™   | XS™   |
| FastvCore™  |  ™ | SyncFET™  |   |
| FlashWriter® *  | PDP SPM™  |  ™ |   |
| FPS™  | Power-SPM™  | The Power Franchise®  |   |
| F-PFS™  | PowerTrench®  |   |   |
|   | PowerXS™  |   |   |

\* EZSWITCH™ and FlashWriter® are trademarks of System General Corporation, used under license by Fairchild Semiconductor.

### DISCLAIMER

FAIRCHILD SEMICONDUCTOR RESERVES THE RIGHT TO MAKE CHANGES WITHOUT FURTHER NOTICE TO ANY PRODUCTS HEREIN TO IMPROVE RELIABILITY, FUNCTION, OR DESIGN. FAIRCHILD DOES NOT ASSUME ANY LIABILITY ARISING OUT OF THE APPLICATION OR USE OF ANY PRODUCT OR CIRCUIT DESCRIBED HEREIN; NEITHER DOES IT CONVEY ANY LICENSE UNDER ITS PATENT RIGHTS, NOR THE RIGHTS OF OTHERS. THESE SPECIFICATIONS DO NOT EXPAND THE TERMS OF FAIRCHILD'S WORLDWIDE TERMS AND CONDITIONS, SPECIFICALLY THE WARRANTY THEREIN, WHICH COVERS THESE PRODUCTS.

### LIFE SUPPORT POLICY

FAIRCHILD'S PRODUCTS ARE NOT AUTHORIZED FOR USE AS CRITICAL COMPONENTS IN LIFE SUPPORT DEVICES OR SYSTEMS WITHOUT THE EXPRESS WRITTEN APPROVAL OF FAIRCHILD SEMICONDUCTOR CORPORATION.

As used herein:

- Life support devices or systems are devices or systems which, (a) are intended for surgical implant into the body or (b) support or sustain life, and (c) whose failure to perform when properly used in accordance with instructions for use provided in the labeling, can be reasonably expected to result in a significant injury of the user.
- A critical component in any component of a life support, device, or system whose failure to perform can be reasonably expected to cause the failure of the life support device or system, or to affect its safety or effectiveness.

### ANTI-COUNTERFEITING POLICY

Fairchild Semiconductor Corporation's Anti-Counterfeiting Policy. Fairchild's Anti-Counterfeiting Policy is also stated on our external website, [www.fairchildsemi.com](http://www.fairchildsemi.com), under Sales Support.

Counterfeiting of semiconductor parts is a growing problem in the industry. All manufacturers of semiconductor products are experiencing counterfeiting of their parts. Customers who inadvertently purchase counterfeit parts experience many problems such as loss of brand reputation, substandard performance, failed applications, and increased cost of production and manufacturing delays. Fairchild is taking strong measures to protect ourselves and our customers from the proliferation of counterfeit parts. Fairchild strongly encourages customers to purchase Fairchild parts either directly from Fairchild or from Authorized Fairchild Distributors who are listed by country on our web page cited above. Products customers buy either from Fairchild directly or from Authorized Fairchild Distributors are genuine parts, have full traceability, meet Fairchild's quality standards for handling and storage and provide access to Fairchild's full range of up-to-date technical and product information. Fairchild and our Authorized Distributors will stand behind all warranties and will appropriately address any warranty issues that may arise. Fairchild will not provide any warranty coverage or other assistance for parts bought from Unauthorized Sources. Fairchild is committed to combat this global problem and encourage our customers to do their part in stopping this practice by buying direct or from authorized distributors.

### PRODUCT STATUS DEFINITIONS

#### Definition of Terms

| Datasheet Identification | Product Status        | Definition  |
|--------------------------|-----------------------|---|
| Advance Information      | Formative / In Design | Datasheet contains the design specifications for product development. Specifications may change in any manner without notice.   |
| Preliminary              | First Production      | Datasheet contains preliminary data; supplementary data will be published at a later date. Fairchild Semiconductor reserves the right to make changes at any time without notice to improve design. |
| No Identification Needed | Full Production       | Datasheet contains final specifications. Fairchild Semiconductor reserves the right to make changes at any time without notice to improve the design.   |
| Obsolete                 | Not In Production     | Datasheet contains specifications on a product that is discontinued by Fairchild Semiconductor. The datasheet is for reference information only.  |

Rev. I37

## X-ON Electronics

Largest Supplier of Electrical and Electronic Components

*Click to view similar products for [High Speed Optocouplers](#) category:*

*Click to view products by [ON Semiconductor](#) manufacturer:*

Other Similar products are found below :

[6N136F](#) [PS8502L2-AX](#) [ACNW261L-000E](#) [ACPL-344JT-000E](#) [ACPL-K49T-500E](#) [ACPL-K74T-000E](#) [ACPL-K75T-000E](#) [ACPL-W21L-560E](#) [ACPL-K44T-500E](#) [TLP187\(TPL,E\(T](#) [TLP2601\(TP1,F\)](#) [610737H](#) [6N137A-X001](#) [6N137A-X017T](#) [6N139-X007T](#) [HCPL2630M](#) [HCPL2731SM](#) [TLP555\(F\)](#) [HCPL2630SM](#) [PS2841-4A-F3-AX](#) [PS9817A-1-F3-AX](#) [PS9821-2-F3-AX](#) [ORPC-817D](#) [ORPC-817M/C](#) [ORPC-817M/B](#) [PT17-51C/L129\(BIN2\)](#) [TLP521-4GBSM](#) [UMW817C](#) [6N137S1\(TA\)](#) [TLP521GB](#) [TLP521GB-S](#) [PS2501](#) [PS2501-S](#) [TLP785GB](#) [TLP785GB-S](#) [LTV-214-G](#) [TLP2766A\(E](#) [TLP2766A\(LF4,E](#) [LCR-0202](#) [EL814S1\(TA\)-V](#) [PC817X4NSZ2B](#) [CYPC817](#) [OR-MOC3023](#) [TLP267J\(TPL,E\(T](#) [TLP109\(TPL,E\(O](#) [EL2514S1\(TU\)\(CLW\)-G](#) [EL816S2\(C\)\(TU\)-F](#) [TLP281-4](#) [MOC3023M](#) [ACPL-K49T-060E](#)