

SPECIFICATION FOR APPROVAL

TO:

2/1

PART NAME	EMI FILTER		
TYPE	FYQ04A1	SAMPLE DATE	MAY.8.2012
MODEL NO			

1. PHYSICAL DIMENSIONS:(mm)

SUGGESTED CUTOUT MOUNTING DIMENSIONS OF SOCKET

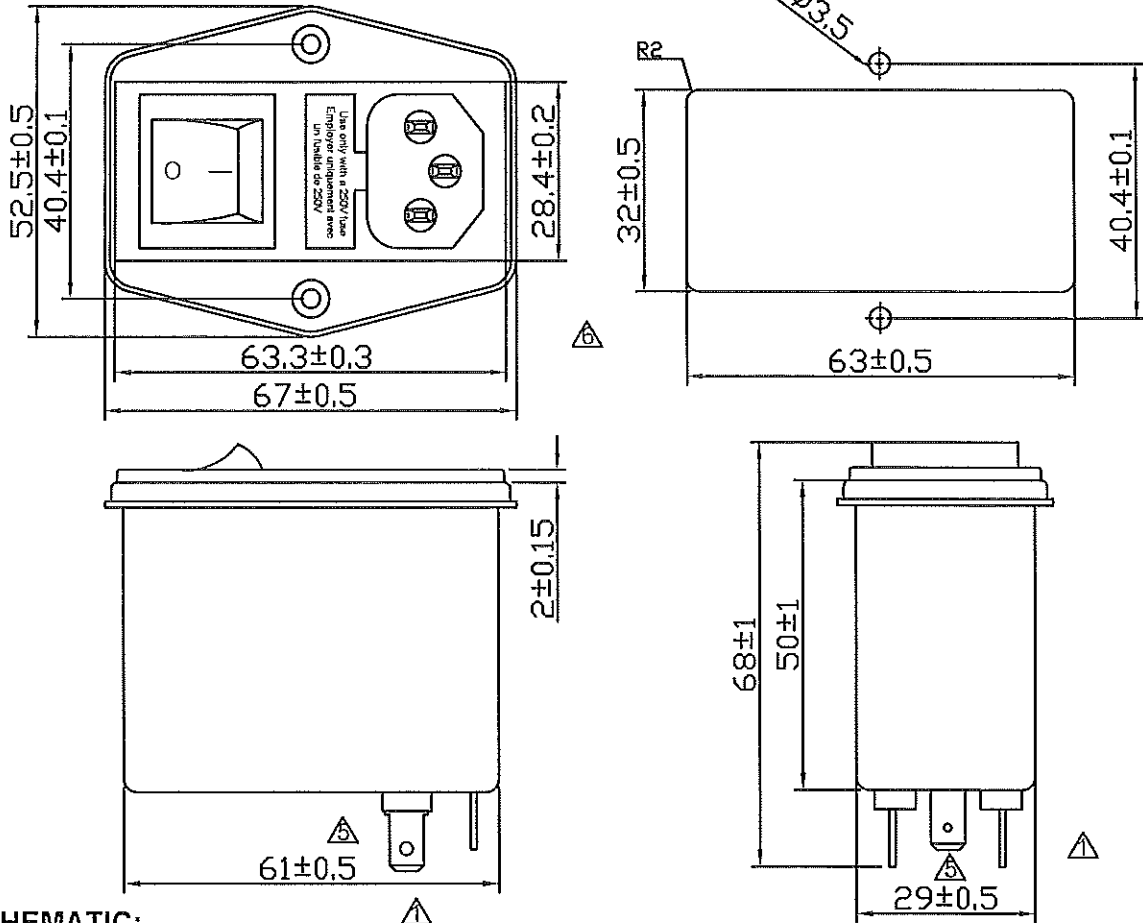

2. SCHEMATIC:

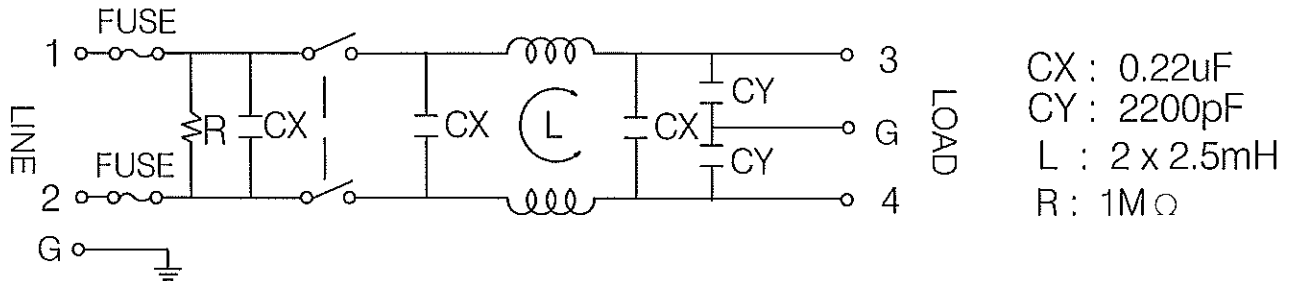

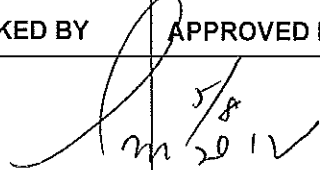
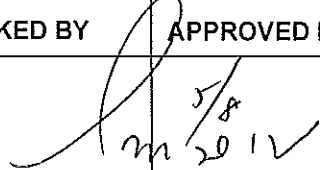
REPORTED BY	CHECKED BY	APPROVED BY	3	VDE號碼更正40006617
			2	增安規CE
			REV. 1	更改端子

156 2/6

SPECIFICATION FOR APPROVAL

TO:

2/2

PART NAME	EMI FILTER		
TYPE	FYQ04A1	SAMPLE DATE	MAY.8.2012
MODEL NO			

3.ELECTRICAL CHARACTERISTICS:

- 3-1.RATED VOLTAGE 125/250VAC
- 3-2.RATED CURRENT 4 A
- 3-3.OPERATING FREQUENCY 50/60Hz
- 3-4.LEAKAGE CURRENT:EACHLINE TO GROUND
250VAC 50Hz 0.6mA MAX
- 3-5.HIPOT RATING:(FOR ONE MINUTE)
LINE TO LINE 1450VDC
LINE TO GROUND 2250VDC
- 3-6.INSULATION RESISTANCE 250VDC/100MOHM MIN
- 3-7.DIRECT CURRENT RESISTANCE 0.2OHM MAX
- 3-8.OPERATING TEMPERATURE -25 TO +100°C

4.SAFETY COMPLINCE:

△ VDE FILE NO:40006617 △
CE

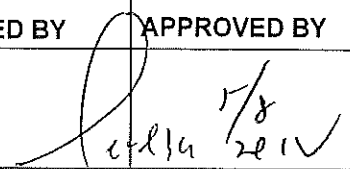
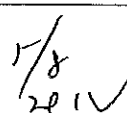
REPORTED BY	CHECKED BY	APPROVED BY	6	插座變更爲奇立插座
 5/8		 1/8 2012	5	端子孔橢圓形更正圓形
			REV. 4	更正線路圖

X-ON Electronics

Largest Supplier of Electrical and Electronic Components

Click to view similar products for [AC Power Entry Modules](#) category:

Click to view products by [QLT Power](#) manufacturer:

Other Similar products are found below :

[0098.0050](#) [6-1609987-9](#) [6167.0002](#) [7-6609955-2](#) [FN389-4-22](#) [FN9233ER-12-06](#) [FN9233S1-10-06](#) [FN9233S1-8-06](#) [FN9233S1B-8-06](#)
[FN9233S1R-1-06](#) [FN9233S1R-12-06](#) [FN9233SB-1-06](#) [FN9233SB-12-06](#) [FN9233SB-8-06](#) [FN9233SR-10-06](#) [FN9233SR-3-06](#) [FN9244B-15-06](#)
[HI](#) [FN9244EB-3-06](#) [FN9244EB-8-06](#) [FN9244ER-15-06](#) [FN9244ER-8-06](#) [FN9244ES1-8-06](#) [FN9244ESB-8-06](#) [FN9244EU-6-06](#)
[FN9244R-12-06](#) [FN9244R-3-07](#) [FN9244R-8-06](#) [FN9244S1-10-06](#) [FN9244S1-12-06](#) [FN9244S1-3-06](#) [FN9244S1B-6-06](#) [FN9244S1R-3-06](#)
[FN9244S-6-06](#) [FN9244SB-10-06](#) [FN9244SB-6-06](#) [FN9244SB-8-06](#) [FN9244SR-10-06](#) [FN9244SR-6-06](#) [FN9244U-3-06](#) [FN9244U-8-06](#)
[FN9260A-6-06](#) [PE00SSSXB](#) [Fuse-H-EUR-1](#) [Fuse-H-USA-1](#) [PM00XD000](#) [PS0SSDBX0](#) [PS0SXSH3B](#) [A-0701-HT-H](#) [RAPC3FG](#) [15EJMS8](#)