

## Features

- RoHS lead-free-solder and lead-solder-exempted products are available.
- Extremely wide input voltage ranges up to 150 VDC
- 4 outputs up to 60 V
- 1200 to 1800 VAC i/o electric strength test
- Electrical isolation between outputs
- Programmable input undervoltage lockout
- Shutdown/inhibit input
- Adjustable output voltages with flexible load distribution
- Frequency synchronization
- Outputs no-load, overload, and short-circuit proof
- Operating ambient temperature from -40 to 85 °C
- Thermal protection
- Low profile: 10.5 mm or 8.9 mm with open frame
- Basic insulation
- Flexible output possibilities between 5 V and 60 V

Safety-approved to IEC/EN 60950-1 and UL/CSA 60950-1 2<sup>nd</sup> Ed.



## Description

The IMX35 Series of board-mountable, 35 Watt DC-DC converters has been designed according to the latest industry requirements and standards. The converters are particularly suitable for use in mobile or stationary applications in transport, railways, industry, or telecommunication, where variable input voltages or high transient voltages are prevalent.

Covering a total input voltage range from 9 V up to 150 V with 4 different models, the converters are available with up to four electrically isolated outputs from 5 V to 60 V, externally adjustable and with flexible load distribution. A shutdown input allows remote converter on/off. Features include consistently high efficiency over the entire input voltage range, high reliability, and excellent dynamic response to load and line changes.

The converters are designed and built according to the international safety standards IEC/EN/UL 60950, and

approved by TÜV and CSA. The converters provide basic insulation.

The circuit is comprised of 2 planar magnetics devices, and all components are automatically assembled and securely soldered onto a single PCB without any wire connection. Magnetic feedback ensures maximum reliability and repeatability in the control loop over all operating conditions. Careful considerations of possible thermal stresses ensure the absence of hot spots providing long life in environments, where temperature cycles are present. The thermal design without using any potting material allows operation at full load up to an ambient temperature of 71 °C in free air and operation up to 105 °C with airflow. For extremely high vibration environments the case has holes for screw mounting.

## Table of Contents

|                              | Page |  | Page |
|------------------------------|------|--|------|
| Description .....            | 1    | Electromagnetic Compatibility (EMC) .....  | 11   |
| Model Selection .....        | 2    | Immunity to Environmental Conditions ..... | 12   |
| Functional Description ..... | 3    | Mechanical Data .....                      | 13   |
| Electrical Input Data .....  | 4    | Safety and Installation Instructions ..... | 14   |
| Electrical Output Data ..... | 6    | Options .....                              | 15   |
| Auxiliary Functions .....    | 9    |  |      |

**Model Selection**

Table 1: Model Selection

| Output 1            |                     | Output 2            |                     | Output 3            |                     | Output 4            |                     | Input voltage<br>$V_{i\ min}$ to $V_{i\ max}$<br>[V] | Efficiency <sup>1</sup> |                     | Model            | Opt.        |
|---------------------|---------------------|---------------------|---------------------|---------------------|---------------------|---------------------|---------------------|--|-------------------------|---------------------|------------------|-------------|
| $V_{o\ nom}$<br>[V] | $I_{o\ nom}$<br>[A] | $V_{o\ nom}$<br>[V] | $I_{o\ nom}$<br>[A] | $V_{o\ nom}$<br>[V] | $I_{o\ nom}$<br>[A] | $V_{o\ nom}$<br>[V] | $I_{o\ nom}$<br>[A] |  | $\eta_{min}$<br>[%]     | $\eta_{typ}$<br>[%] |                  |             |
| 5                   | 1.35                | 5                   | 1.35                | 5                   | 1.35                | 5                   | 1.35                | 9 to 36  | 82.5                    | 86                  | 20IMX35D05D05-8  | i<br>Z<br>G |
| 5                   | 1.4                 | 5                   | 1.4                 | 5                   | 1.4                 | 5                   | 1.4                 | 18 to 75   | 82                      | 87                  | 40IMX35D05D05-8  |             |
| 5                   | 1.4                 | 5                   | 1.4                 | 5                   | 1.4                 | 5                   | 1.4                 | 40 to 121  | 83                      | 86                  | 70IMX35D05D05-8  |             |
| 5                   | 1.4                 | 5                   | 1.4                 | 5                   | 1.4                 | 5                   | 1.4                 | 60 to 150 <sup>2</sup>                               | 82                      | 86                  | 110IMX35D05D05-8 |             |
| 12                  | 0.65                | 12                  | 0.65                | 12                  | 0.65                | 12                  | 0.65                | 9 to 36  | 83.7                    | 86                  | 20IMX35D12D12-8  |             |
| 12                  | 0.7                 | 12                  | 0.7                 | 12                  | 0.7                 | 12                  | 0.7                 | 18 to 75   | 83.7                    | 88                  | 40IMX35D12D12-8  |             |
| 12                  | 0.7                 | 12                  | 0.7                 | 12                  | 0.7                 | 12                  | 0.7                 | 40 to 121  | 85                      | 88                  | 70IMX35D12D12-8  |             |
| 12                  | 0.7                 | 12                  | 0.7                 | 12                  | 0.7                 | 12                  | 0.7                 | 60 to 150 <sup>2</sup>                               | 84                      | 88                  | 110IMX35D12D12-8 |             |
| 15                  | 0.55                | 15                  | 0.55                | 15                  | 0.55                | 15                  | 0.55                | 9 to 36  | 85                      | 88                  | 20IMX35D15D15-8  |             |
| 15                  | 0.6                 | 15                  | 0.6                 | 15                  | 0.6                 | 15                  | 0.6                 | 18 to 75   | 83.6                    | 89                  | 40IMX35D15D15-8  |             |
| 15                  | 0.6                 | 15                  | 0.6                 | 15                  | 0.6                 | 15                  | 0.6                 | 40 to 121  | 84.5                    | 88                  | 70IMX35D15D15-8  |             |
| 15                  | 0.6                 | 15                  | 0.6                 | 15                  | 0.6                 | 15                  | 0.6                 | 60 to 150 <sup>2</sup>                               | 83                      | 88                  | 110IMX35D15D15-8 |             |
| 5                   | 1.35                | 12                  | 0.65                | 12                  | 0.65                | 5                   | 1.35                | 9 to 36  | 84                      | 88                  | 20IMX35D05D12-8  |             |
| 5                   | 1.4                 | 12                  | 0.7                 | 12                  | 0.7                 | 5                   | 1.4                 | 18 to 75   | 84                      | 89                  | 40IMX35D05D12-8  |             |
| 5                   | 1.4                 | 12                  | 0.7                 | 12                  | 0.7                 | 5                   | 1.4                 | 40 to 121  | 84                      | 88                  | 70IMX35D05D12-8  |             |
| 5                   | 1.4                 | 12                  | 0.7                 | 12                  | 0.7                 | 5                   | 1.4                 | 60 to 150 <sup>2</sup>                               | 83.6                    | 88                  | 110IMX35D05D12-8 |             |
| 5                   | 1.35                | 15                  | 0.55                | 15                  | 0.55                | 5                   | 1.35                | 9 to 36  | 83.5                    | 88                  | 20IMX35D05D15-8  |             |
| 5                   | 1.4                 | 15                  | 0.6                 | 15                  | 0.6                 | 5                   | 1.4                 | 18 to 75   | 83.5                    | 89                  | 40IMX35D05D15-8  |             |
| 5                   | 1.4                 | 15                  | 0.6                 | 15                  | 0.6                 | 5                   | 1.4                 | 40 to 121  | 84                      | 88                  | 70IMX35D05D15-8  |             |
| 5                   | 1.4                 | 15                  | 0.6                 | 15                  | 0.6                 | 5                   | 1.4                 | 60 to 150 <sup>2</sup>                               | 84                      | 88                  | 110IMX35D05D15-8 |             |

<sup>1</sup> Efficiency at  $T_A = 25\ ^\circ\text{C}$ ,  $V_{o\ nom}$ ,  $I_{o\ nom}$   
<sup>2</sup> 154 V for 2 s.

**Part Number Description**

Input voltage range  $V_i$   
 9 to 36 VDC ..... 20  
 18 to 75 VDC ..... 40  
 40 to 121 VDC ..... 70  
 60 to 150 VDC ..... 110

Series ..... IMX35

Outputs 1 and 4 (1<sup>st</sup> power train) ..... D05, D12, D15

Outputs 2 and 3 (2<sup>nd</sup> power train) ..... D05, D12, D15

Operating ambient temperature range  
 $T_A = -40$  to  $85\ ^\circ\text{C}$  ..... -8

Options: Inhibit ..... -i  
 Open frame ..... Z  
 RoHS compliant for all six substances ..... G<sup>1</sup>

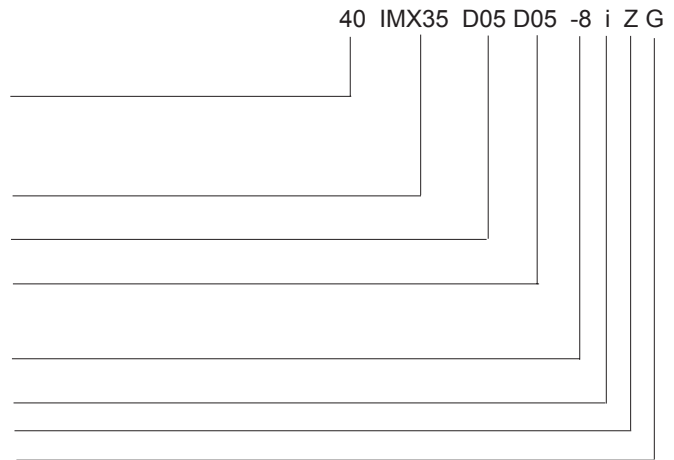

<sup>1</sup> G is always placed at the end of the part number.

Preferred for new designs

**Product Marking**

Converters without option Z are marked with type designation, input and output voltages and currents, applicable safety approval and recognition marks, company logo, production date, and serial no.

## Functional Description

The IMX35 converters are comprised of 2 feedback-controlled interleaved-switching flyback power trains using current mode PWM (pulse width modulation).

Each converter consists of 4 electrically isolated outputs deriving from 2 power trains. Vo1, Vo4 derive from the first power train and Vo2, Vo3 from the second one. Thus each pair of outputs is independent from the other one.

Voltage regulation for each pair of outputs is achieved with passive transformer feedback from the main transformer of the power train. Each pair of outputs has the same output voltage (i.e. D05, D12, etc.). If both power trains have the same output

voltage (e.g. D12D12), all outputs may be simultaneously adjusted by the Trim input (pin 5). In case of different output voltages (e.g. D05D15), the Trim1 input influences only Vo1 and Vo4.

Current limitation is provided by the primary circuit for each power train and limits the possible output power for each pair of outputs. In the case of an overload on either of the power trains, which causes the output voltage to fall less than typically 60% of  $V_{o,nom}$ , the entire converter will shut down and automatically restart in short intervals (hiccup mode).

The incorporated overtemperature protection shuts down the converter in excessive overload conditions with automatic restart.

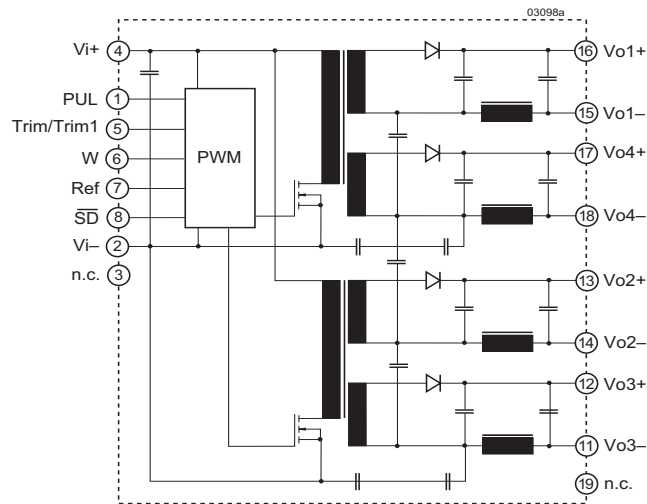

Fig. 1  
Block diagram of quad-output models

## Electrical Input Data

General conditions:

$T_A = 25\text{ }^\circ\text{C}$ , unless specified

Pins 8 (shutdown or i), 6 (W), 5 (Trim or Trim1), and 1 (PUL) left open-circuit (not connected), unless specified.

Table 2: Input Data

| Input                      |                                      |   | 20IMX35                 |     |     | 40IMX35                 |     |     | Unit             |
|----------------------------|--------------------------------------|---|-------------------------|-----|-----|-------------------------|-----|-----|------------------|
| Characteristics            |                                      | Conditions  | min                     | typ | max | min                     | typ | max |                  |
| $V_i$                      | Input voltage range <sup>1</sup>     | $T_{A\text{ min}}$ to $T_{A\text{ max}}$<br>$I_o = 0$ to $I_{o\text{ nom}}$ | 9 <sup>2</sup>          |     | 36  | 18 <sup>2</sup>         |     | 75  | VDC              |
| $V_{i\text{ nom}}$         | Nominal input voltage                |   | 20                      |     |     | 40                      |     |     |                  |
| $V_{i\text{ sur}}$         | Repetitive surge voltage             | Abs. max input (3 s)  | 40                      |     |     | 100                     |     |     |                  |
| $t_{\text{start-up}}$      | Converter start-up time <sup>2</sup> | Switch on   | 0.25                    |     | 0.5 | 0.25                    |     | 0.5 | s                |
|                            |                                      | $\overline{\text{SD}}$ high   |                         |     | 0.1 |                         |     | 0.1 |                  |
| $t_{\text{rise}}$          | Rise time <sup>3</sup>               | $V_{i\text{ nom}}$ resist load  | 3                       |     |     | 3                       |     |     | ms               |
|                            |                                      | $I_{o\text{ nom}}$ capac. load  | 6                       | 12  |     | 6                       | 12  |     |                  |
| $I_{i\text{ o}}$           | No load input current                | $I_o = 0$ , $V_{i\text{ min}}$ to $V_{i\text{ max}}$                        | 70                      |     |     | 50                      |     |     | mA               |
| $I_{\text{irr}}$           | Reflected ripple current             | $I_o = 0$ to $I_{o\text{ nom}}$   | 30                      |     |     | 30                      |     |     | mA <sub>pp</sub> |
| $I_{\text{inr p}}$         | Inrush peak current <sup>4</sup>     | $V_i = V_{i\text{ nom}}$  | 8                       |     |     | 9                       |     |     | A                |
| $C_i$                      | Input capacitance                    | for surge calculation   | 2                       |     |     | 1.3                     |     |     | $\mu\text{F}$    |
| $V_{\overline{\text{SD}}}$ | Shut down voltage                    | Converter disabled  | -10 to 0.7              |     |     | -10 to 0.7              |     |     | V                |
|                            |                                      | Converter operating   | open circuit or 2 to 20 |     |     | open circuit or 2 to 20 |     |     |                  |
| $R_{\overline{\text{SD}}}$ | Shutdown input resistance            |   | approx. 10              |     |     | approx. 10              |     |     | k $\Omega$       |
| $I_{\overline{\text{SD}}}$ | Input current during shutdown        | $V_{i\text{ min}}$ to $V_{i\text{ max}}$                                    | 12                      |     |     | 6                       |     |     | mA               |
| $f_s$                      | Switching frequency                  | $V_{i\text{ min}}$ to $V_{i\text{ max}}$ , $I_o = 0$ to $I_{o\text{ nom}}$  | 220                     | 240 |     | 220                     | 240 |     | kHz              |

| Input                      |                                      |   | 70IMX35                 |     |     | 110IMX35                |     |                  | Unit             |
|----------------------------|--------------------------------------|---|-------------------------|-----|-----|-------------------------|-----|------------------|------------------|
| Characteristics            |                                      | Conditions  | min                     | typ | max | min                     | typ | max              |                  |
| $V_i$                      | Input voltage range <sup>1</sup>     | $T_{A\text{ min}}$ to $T_{A\text{ max}}$<br>$I_o = 0$ to $I_{o\text{ nom}}$ | 40 <sup>2</sup>         |     | 121 | 60 <sup>2</sup>         |     | 150 <sup>5</sup> | VDC              |
| $V_{i\text{ nom}}$         | Nominal input voltage                |   | 70                      |     |     | 110                     |     |                  |                  |
| $V_{i\text{ sur}}$         | Repetitive surge voltage             | Abs. max input (3 s)  | 150                     |     |     | 170                     |     |                  |                  |
| $t_{\text{start-up}}$      | Converter start-up time <sup>2</sup> | Switch on   | 0.25                    |     | 0.5 | 0.4                     |     | 0.7              | s                |
|                            |                                      | $\overline{\text{SD}}$ high   |                         |     | 0.1 |                         |     | 0.1              |                  |
| $t_{\text{rise}}$          | Rise time <sup>3</sup>               | $V_{i\text{ nom}}$ resist load  | 3                       |     |     | 3                       |     |                  | ms               |
|                            |                                      | $I_{o\text{ nom}}$ capac. load  | 6                       | 12  |     | 6                       | 12  |                  |                  |
| $I_{i\text{ o}}$           | No load input current                | $I_o = 0$ , $V_{i\text{ min}}$ to $V_{i\text{ max}}$                        | 30                      |     |     | 20                      |     |                  | mA               |
| $I_{\text{irr}}$           | Reflected ripple current             | $I_o = 0$ to $I_{o\text{ nom}}$   | 30                      |     |     | 30                      |     |                  | mA <sub>pp</sub> |
| $I_{\text{inr p}}$         | Inrush peak current <sup>4</sup>     | $V_i = V_{i\text{ nom}}$  | 7                       |     |     | 7                       |     |                  | A                |
| $C_i$                      | Input capacitance                    | for surge calculation   | 0.5                     |     |     | 0.5                     |     |                  | $\mu\text{F}$    |
| $V_{\overline{\text{SD}}}$ | Shut down voltage                    | Converter disabled  | -10 to 0.7              |     |     | -10 to 0.7              |     |                  | V                |
|                            |                                      | Converter operating   | open circuit or 2 to 20 |     |     | open circuit or 2 to 20 |     |                  |                  |
| $R_{\overline{\text{SD}}}$ | Shutdown input resistance            |   | approx. 10              |     |     | approx. 10              |     |                  | k $\Omega$       |
| $I_{\overline{\text{SD}}}$ | Input current during shutdown        | $V_{i\text{ min}}$ to $V_{i\text{ max}}$                                    | 5                       |     |     | 5                       |     |                  | mA               |
| $f_s$                      | Switching frequency                  | $V_{i\text{ min}}$ to $V_{i\text{ max}}$ , $I_o = 0$ to $I_{o\text{ nom}}$  | 220                     | 240 |     | 220                     | 240 |                  | kHz              |

<sup>1</sup>  $V_{i\text{ min}}$  will not be as stated, if  $V_o$  is increased above  $V_{o\text{ nom}}$  by use of Trim input. If the output voltage is set to a higher value,  $V_{i\text{ min}}$  will be proportionately increased.

<sup>2</sup> Input undervoltage lockout at typ. 85% of  $V_{i\text{ min}}$ .

<sup>3</sup> Measured with resistive and max. admissible capacitive load.

<sup>4</sup> Source impedance according to ETS 300132-2, version 4.3.

<sup>5</sup> 154 V during 2 s

### Inrush Current

The inrush current has been kept as low as possible by choosing a very small input capacitance. A series resistor may be installed in the input line in order to further reduce this current.

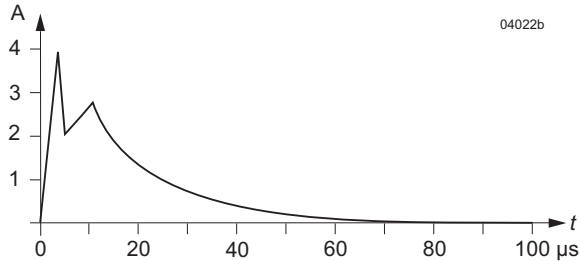

**Fig. 2**  
Typical inrush current at  $V_{i\text{ nom}}$ ,  $P_{o\text{ nom}}$  versus time (40IMX35).  
Source impedance according to ETS 300132-2 at  $V_{i\text{ nom}}$ .

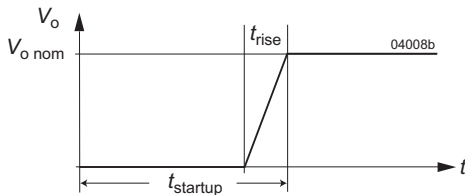

**Fig. 3**  
Converter start-up and rise time (see table 2)

### Reverse Polarity Protection

The built-in suppressor diode also provides for reverse polarity protection at the input by conducting current in the reverse direction. An external fuse is required to limit this current.

Table 3: Recommended external fuses in the non-earthed input line

| Converter model | Fuse type |
|-----------------|-----------|
| 20IMX35         | F8.0A     |
| 40IMX35         | F4.0A     |
| 70IMX35         | F2.0A     |
| 110IMX35        | F1.5A     |

### Input Transient Voltage Protection

A built-in suppressor diode provides effective protection against input transients, which may be generated for example by short-circuits across the input lines, where the network inductance may cause high energy pulses.

Table 4: Built-in transient voltage suppressor

| Model    | Breakdown voltage $V_{Br\text{ nom}}$ [V] | Peak power at 1 ms $P_p$ [W] | Peak pulse current $I_{pp}$ [A] |
|----------|---|------------------------------|---------------------------------|
| 20IMX35  | 39  | 1500                         | 22                              |
| 40IMX35  | 100                                       | 1500                         | 9.7                             |
| 70IMX35  | 151                                       | 600                          | 2.9                             |
| 110IMX35 | 176                                       | 600                          | 2.5                             |

For very high energy transients as for example to achieve IEC/EN 61000-4-5 compliance (as per table *Electromagnetic Immunity*) an external inductor and capacitor are required. The components should have similar characteristics as listed in table below.

Table 5: Components for external circuitry for IEC/EN 61000-4-5, level 2

| Model    | Inductor (L)        | Capacitor (C)           | Diode (D)  |
|----------|---------------------|-------------------------|------------|
| 20IMX35  | 22 $\mu$ H / 5 A    | 470 $\mu$ F / 40 V      | 1.5 k E47A |
| 40IMX35  | 68 $\mu$ H / 2.7 A  | 2 x 100 $\mu$ F / 100 V | -          |
| 70IMX35  | 100 $\mu$ H / 1 A   | 2 x 82 $\mu$ F / 200 V  | -          |
| 110IMX35 | 150 $\mu$ H / 0.8 A | 2 x 82 $\mu$ F / 200 V  | -          |

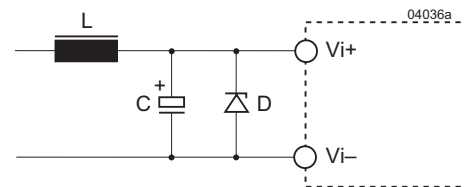

**Fig. 4**  
Example for external circuitry to comply with IEC/EN 61000-4-5; the diode D is only necessary for 20IMX35 models.

## Electrical Output Data

General conditions:

- $T_A = 25\text{ °C}$ , unless  $T_C$  is specified
- Pins 8 (shutdown or i), 6 (W), 5 (Trim or Trim1), and 1 (PUL) left open-circuit (not connected), unless specified.

Table 6: Output data per double-output power train (Vo1/Vo4 or Vo2/Vo3; each power train has 2 outputs)

| Output                             |   |   | 2 x 5 V  |      |     | 2 x 12 V |       |     | 2 x 15 V |       |     | Unit             |
|------------------------------------|---|---|----------|------|-----|----------|-------|-----|----------|-------|-----|------------------|
| Characteristics                    |   | Conditions  | min      | typ  | max | min      | typ   | max | min      | typ   | max |                  |
| V <sub>o1</sub><br>V <sub>o2</sub> | Output voltage  | V <sub>i nom</sub><br>I <sub>o</sub> = 0.5 I <sub>o nom</sub>   | 4.95     | 5.05 |     | 11.88    | 12.12 |     | 14.85    | 15.15 |     | VDC              |
| I <sub>o nom</sub>                 | Output current  | V <sub>i min</sub> to V <sub>i max</sub>  | 2 x 1.35 |      |     | 2 x 0.65 |       |     | 2 x 0.55 |       |     | A                |
|                                    |   |   | 2 x 1.4  |      |     | 2 x 0.70 |       |     | 2 x 0.60 |       |     |                  |
|                                    |   |   | 2 x 1.4  |      |     | 2 x 0.70 |       |     | 2 x 0.60 |       |     |                  |
|                                    |   |   | 2 x 1.4  |      |     | 2 x 0.70 |       |     | 2 x 0.60 |       |     |                  |
| I <sub>oL</sub>                    | Current limit <sup>1</sup>                                  | V <sub>i nom</sub> , T <sub>C</sub> = 25 °C<br>V <sub>o</sub> = 93% V <sub>o nom</sub>                    | 3.5      |      |     | 1.8      |       |     | 1.5      |       |     |                  |
|                                    |   |   | 3.8      |      |     | 2.0      |       |     | 1.7      |       |     |                  |
|                                    |   |   | 3.8      |      |     | 2.0      |       |     | 1.7      |       |     |                  |
|                                    |   |   | 3.8      |      |     | 2.0      |       |     | 1.7      |       |     |                  |
| ΔV <sub>o</sub>                    | Line regulation   | V <sub>i min</sub> to V <sub>i max</sub> , I <sub>o nom</sub>   | ±1       |      |     | ±1       |       |     | ±1       |       |     | %                |
| ΔV <sub>o1</sub>                   | Load regulation   | V <sub>i nom</sub><br>I <sub>o</sub> = (0.1 to 1) I <sub>o nom</sub>                                      | ±3       |      |     | ±3       |       |     | ±3       |       |     |                  |
| V <sub>o1/2</sub>                  | Output voltage noise  | V <sub>i min</sub> to V <sub>i max</sub> <sup>2</sup><br>I <sub>o</sub> = I <sub>o nom</sub> <sup>3</sup> | 80       |      |     | 120      |       |     | 150      |       |     | mV <sub>pp</sub> |
|                                    |   |   | 40       |      |     | 60       |       |     | 70       |       |     |                  |
| V <sub>oL</sub>                    | Output overvoltage limit. <sup>4</sup>                      | Min. load 1%  | 115      | 130  |     | 115      | 130   |     | 115      | 130   |     | %                |
| C <sub>o ext</sub>                 | Admissible capacitive load per power train <sup>5</sup>     | produced after 2011   | 0        | 6000 |     | 0        | 680   |     | 0        | 470   |     | μF               |
| V <sub>o d</sub>                   | Dynamic load regulation                                     | Voltage deviat.<br>Recovery time  | ±250     |      |     | ±480     |       |     | ±520     |       |     | mV               |
| t <sub>d</sub>                     |   |   | 0.75     |      |     | 0.75     |       |     | 0.75     |       |     |                  |
| α <sub>Vo</sub>                    | Temperature coefficient<br>ΔV <sub>o</sub> /ΔT <sub>C</sub> | V <sub>i min</sub> to V <sub>i max</sub><br>I <sub>o</sub> = (0.1 to 1) I <sub>o nom</sub>                | ±0.02    |      |     | ±0.02    |       |     | ±0.02    |       |     | %/K              |

<sup>1</sup> Both outputs of each power train connected in parallel. The current limit is primary side controlled. In the event of a sustained overload condition, the thermal protection may cause the converter to shut down (restart on cool-down).

<sup>2</sup> BW = 20 MHz, measured with an external capacitor of 1 μF across the output pins.

<sup>3</sup> Measured with a probe according to EN 61204

<sup>4</sup> The overvoltage protection is via a primary side second regulation loop, not tracking with Trim control.

<sup>5</sup> Sum of the capacities on both outputs of each power train

### Thermal Considerations

If a converter, mounted on a PCB, is located in free, quasi-stationary air (convection cooling) at the indicated maximum ambient temperature  $T_{A \max}$  (see table *Temperature specifications*) and is operated at its nominal input voltage and output power, the case temperature  $T_C$  ( $T_{CZ}$  with option Z) measured at the measuring point of case temperature (see *Mechanical Data*) will approach the indicated value  $T_{C \max}$  after the warm-up phase. However, the relationship between  $T_A$  and  $T_C$  depends heavily on the conditions of operation and integration into a system. The thermal conditions are influenced by input voltage, output current, airflow, temperature of surrounding components and the surfaces and properties of the printed circuit board.  $T_{A \max}$  is therefore only an indicative value, and under practical operating conditions, the ambient temperature  $T_A$  may be higher or lower than this value.

**Caution:** The case temperature  $T_C$  (or  $T_{CZ}$ ) measured at the measuring point of case temperature (see *Mechanical Data*) may under no circumstances exceed the specified maximum value. The installer must ensure that under all operating conditions  $T_C$  (or  $T_{CZ}$ ) remains within the limits stated in the table *Temperature specifications*.

The converters provide the specified output power with free air convection cooling. In the upper temperature range the output power derating below should be observed.

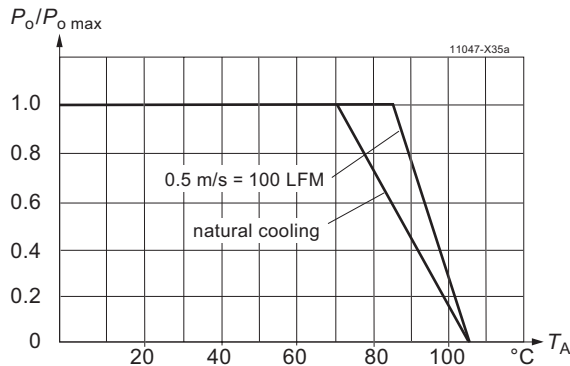

Fig. 5  
Maximum allowed output power versus ambient temperature.

### Overtemperature Protection

The converter is protected against possible overheating by means of an internal temperature monitoring circuit. It shuts down the converter above the internal temperature limit and attempts to automatically restart. This feature prevents excessive internal temperature building up which could occur under heavy overload conditions.

### Short Circuit Behavior

The current limit characteristic shuts down the converter whenever a short circuit is applied to an output. It acts self-protecting and automatically recovers after removal of the overload condition (hiccup mode).

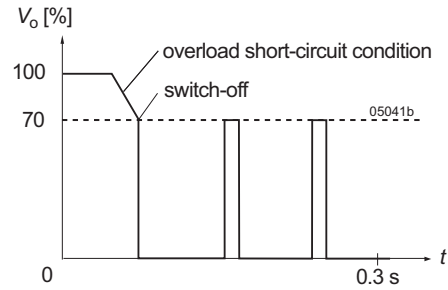

Fig. 6  
Overload switch off (hiccup mode), typical values.

### Series and Parallel Connection

The outputs of one or several double-output power trains may be connected in series respecting the current limitation.

Both outputs of the same power train can always be connected in parallel in will behave like a single output.

Several outputs of the same converter with equal output voltage (e.g. 5 V / 5 V) can be connected in parallel and will share their output currents almost equally.

If outputs of the same converter are being parallel and series-connected, it is recommended that outputs from the same power trains are parallel-connected first. This applies for instance, if 24 V shall be generated by a converter with four 12 V outputs; see fig. 7.

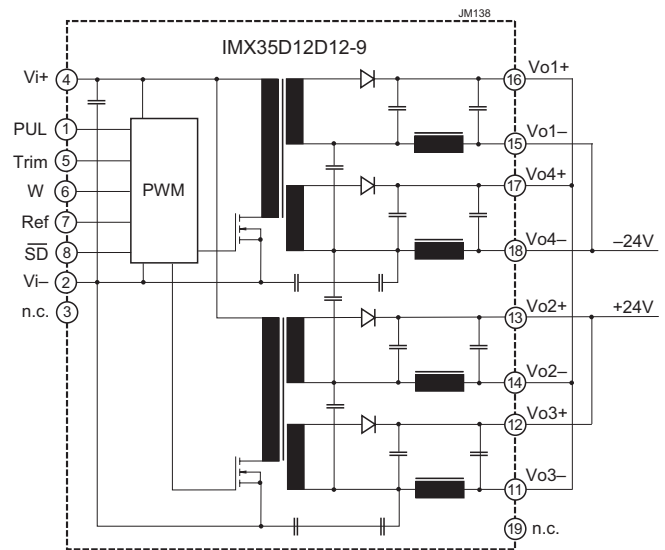

Fig. 7  
Generating 24 V with an IMX35D12D12-9

**Note:** Parallel operation of several converters may cause start-up problems. This becomes noticeable in applications, where one converter is not able to deliver alone the full resistive and capacitive load current, as it is required in true redundant systems.

**Typical Performance Curves**

General conditions:

- $T_A = 25^\circ\text{C}$ , unless  $T_C$  is specified.
- Shut down and Trim pin left open-circuit.

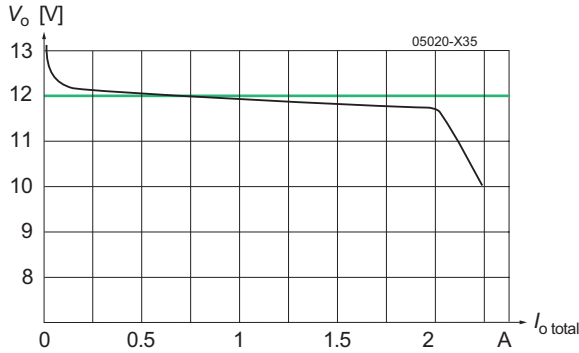

Fig. 8

$V_o$  versus  $I_o$  (typ.) of double-output power trains, with both outputs in parallel (e.g.,  $V_{o1/4}$  of a 40IMX35D12D12)

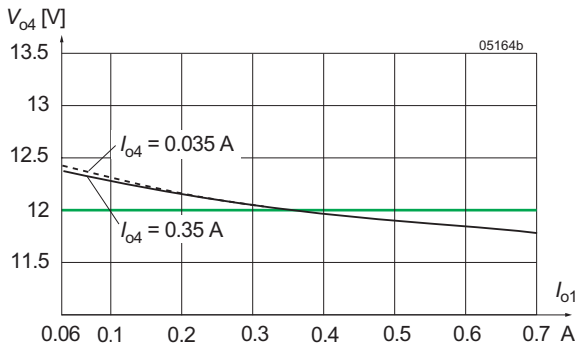

Fig. 9

Cross load regulation (typ.) on power train 1.  $V_{o4}$  versus  $I_{o1}$

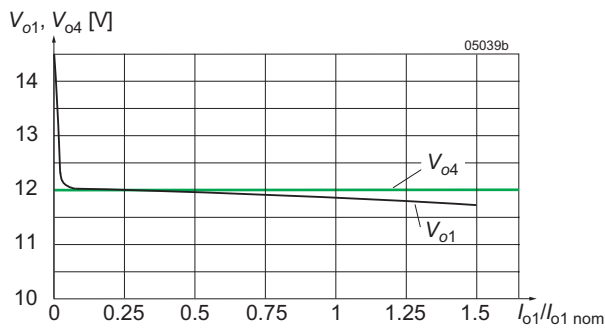

Fig. 10

Flexible load distribution (typ.) on power train 1 of a 40IMX35D12D12-8:

$V_{o1}$  versus  $I_{o1}$ ,  $I_{o4} = 0.5 I_{o4 \text{ nom}}$

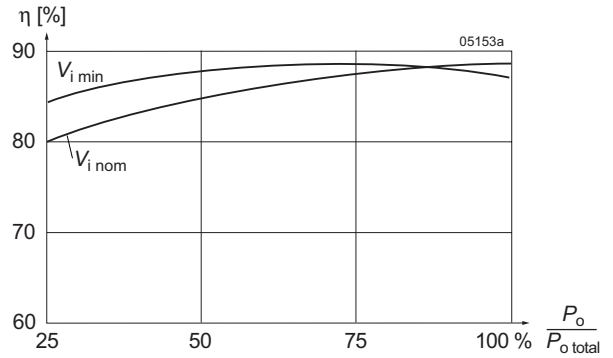

Fig. 11

Efficiency versus input voltage and load. Typical values (20IMX35D12D12-8)

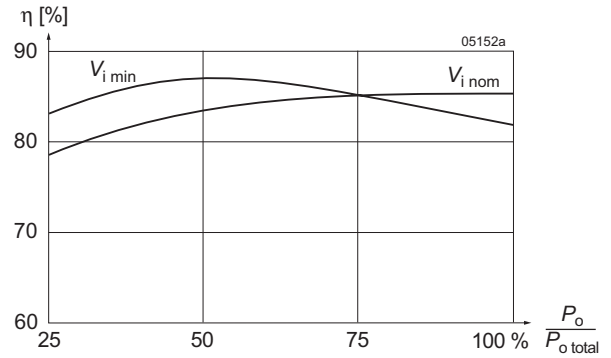

Fig. 12

Efficiency versus input voltage and load. Typical values (40IMX35D12D12-8)



## Auxiliary Functions

### Adjustable Output Voltage

As a standard feature, the IMX35 offer adjustable output voltages in the range of 85 to 105% of  $V_{o\text{ nom}}$ . Fig. 12 shows the schematic diagram for the adjustment of quad-output models.

All models with equal output voltages have a Trim input at pin 5 referenced to the primary side, influencing all outputs simultaneously. Models with different output voltages exhibit a Trim1 input, influencing only the first power train ( $V_{o1}$  and  $V_{o4}$ ).

### Adjustment by means of an external resistor $R_{\text{ext}}$ :

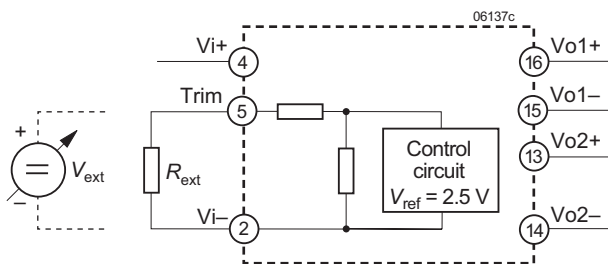

Fig. 13

Output voltage control by means of the Trim input

Adjustment of the output voltage by means of an external resistor  $R_{\text{ext}}$  is possible within the range of 100 to 105% of  $V_{o\text{ nom}}$ .  $R_{\text{ext}}$  should be connected between Trim (pin 5) and  $V_{i-}$  (pin 2). The following table indicates suitable resistor values for typical output voltages under nominal conditions ( $V_{i\text{ nom}}$ ,  $I_o = 0.5 I_{o\text{ nom}}$ ).

Note: Connection of  $R_{\text{ext}}$  to  $V_{i+}$  may damage the converter.

### Adjustment by means of an external voltage source $V_{\text{ext}}$

Table 7:  $R_{\text{ext}}$  for  $V_o > V_{o\text{ nom}}$ ;  
approximate values ( $V_{i\text{ nom}}$ ,  $I_o = 0.5 I_{o\text{ nom}}$ )

| $V_o$ [% $V_{o\text{ nom}}$ ] | $R_{\text{ext}}$ [k $\Omega$ ] |          |
|-------------------------------|--------------------------------|----------|
|                               | Trim                           | Trim1    |
| 105 to 108 (107 typically)    | 0                              | 0        |
| 105                           | 10                             | 17       |
| 102                           | 62                             | 110      |
| 100                           | $\infty$                       | $\infty$ |

For external output voltage adjustment in the range 85 to 105% of  $V_{o\text{ nom}}$  a voltage source  $V_{\text{ext}}$  (0 to 20 V) is required, connected to Trim or Trim1 (pin 5) and  $V_{i-}$ . The table below indicates typical values  $V_o$  versus  $V_{\text{ext}}$ . Applying a control voltage of 15 to 20 V will set the converter into the hiccup mode. Direct paralleling of the Trim pins of converters of the same type connected in parallel is feasible.

Table 8:  $V_o$  versus  $V_{\text{ext}}$  for  $V_o = 85$  to  $105\%$   $V_{o\text{ nom}}$ ;  
typical values ( $V_{i\text{ nom}}$ ,  $I_o = 0.5 I_{o\text{ nom}}$ )

| $V_o$ [% $V_{o\text{ nom}}$ ] | $V_{\text{ext}}$ [V] |           |
|-------------------------------|----------------------|-----------|
|                               | Trim [V]             | Trim1 [V] |
| >105                          | 0                    | 0         |
| 102                           | 1.8                  | 1.5       |
| 100                           | 2.5                  | 2.5       |
| 95                            | 4.3                  | 4.25      |
| 90                            | 6.2                  | 6.2       |
| 85                            | 8                    | 8         |

### Synchronization (W)

It is possible to synchronize the switching frequency of one or more converters to an external clock signal.

This logic input W can be used to synchronize the oscillator to an external frequency source. This signal is edge-triggered with TTL thresholds and requires a source frequency of 490 to 540 kHz (duty cycle 10 to 90%). The external source frequency is internally divided by 2 to define the switching frequency of the converter. If unused, this pin can be connected to  $V_{1-}$  (pin 2) or left open-circuit.

### Reference Output (Ref)

The converter provides a stable 5 V ( $\pm 0.1$  V) reference signal on pin 7 (Ref). The output is protected by a 1 k $\Omega$  resistor. The signal may be used also in conjunction with the Trim input (pin 5) as a limited external voltage reference.

It is recommended to connect a filter capacitor (0.1  $\mu$ F) between Ref and  $V_{i-}$ , if Ref is used.

### Shutdown

The outputs of the converters may be enabled or disabled by means of a logic signal (TTL, CMOS, etc.) applied to shutdown (pin 8). If the shutdown function is not required, pin 8 should be left open-circuit:

|                      |              |
|----------------------|--------------|
| Converter operating: | 2.0 to 20 V  |
| Converter disabled:  | -10 to 0.7 V |

### Progr. Input Undervoltage Lockout PUL

A special feature of the converters (with Rev. BA or later) is the adjustable undervoltage lockout protection, which protects the converter (and the system) from high current caused by operation at low input voltages. This ensures easier start-up in distributed power systems.

The table below shows the band of switch on/off and the hysteresis.

Table 9: Trigger level and hysteresis (pin 1 left open)

| Model    | Trigger level | Hysteresis | Unit |
|----------|---------------|------------|------|
| 20IMX35  | 7 to 8        | <0.5       | V    |
| 40IMX35  | 14 to 15.5    | <1         |      |
| 70IMX35  | 31 to 34      | <3         |      |
| 110IMX35 | 42 to 50      | <8         |      |

The undervoltage lockout levels may be programmed by using an external resistor  $R_{PUL}$  between PUL and Vi- to increase the preset levels as specified in table 10.

Table 10: Typical values for  $R_{PUL}$  and the respective lockout voltage for input voltage.

| 20IMX35        |                  | 40IMX35        |                  |
|----------------|------------------|----------------|------------------|
| $R_{PUL}$ [kW] | $V_{i\ min}$ [V] | $R_{PUL}$ [kW] | $V_{i\ min}$ [V] |
| $\infty$       | $\leq 8$         | $\infty$       | $\leq 15.5$      |
| 39             | 10               | 43             | 22               |
| 19             | 12               | 16             | 26               |
| 13             | 14               | 10             | 28               |
| 9.1            | 16               | 0              | 32               |

| 70IMX35        |                  | 110IMX35       |                  |
|----------------|------------------|----------------|------------------|
| $R_{PUL}$ [kW] | $V_{i\ min}$ [V] | $R_{PUL}$ [kW] | $V_{i\ min}$ [V] |
| $\infty$       | 31               | $\infty$       | 42               |
| 270            | 40               | 270            | 50               |
| 110            | 50               | 120            | 60               |
| 80             | 55               | 51             | 75               |

## Electromagnetic Compatibility (EMC)

A suppressor diode together with an input filter form an

effective protection against high input transient voltages which typically occur in many installations, but especially in battery-driven mobile applications.

## Electromagnetic Immunity

Table 11: Immunity type tests

| Phenomenon                       | Standard         | Class Level    | Coupling mode <sup>1</sup>        | Value applied        | Waveform  | Source imped. | Test procedure   | In oper. | Perf. crit. <sup>2</sup> |
|----------------------------------|------------------|----------------|-----------------------------------|----------------------|---|---------------|--|----------|--------------------------|
| Electrostatic discharge to case  | IEC/EN 61000-4-2 | 2              | contact discharge (Trim pin open) | 4000 V <sub>p</sub>  | 1/50 ns   | 330 Ω         | 10 positive and 10 negative discharges                             | yes      | B                        |
|                                  |                  | 3              | air discharge (Trim pin open)     | 8000 V <sub>p</sub>  |   |               |  |          |                          |
| Electromagnetic field            | IEC/EN 61000-4-3 | 3 <sup>3</sup> | antenna                           | 10 V/m               | AM 80%<br>1 kHz   | n.a.          | 80 to 1000 MHz   | yes      | A                        |
|                                  | ENV 50204        | 3              | antenna                           | 10 V/m               | PM, 50% duty cycle, 200 Hz repetition frequ.                            | n.a.          | 900 MHz  | yes      | A                        |
| Electrical fast transients/burst | IEC/EN 61000-4-4 | 4              | direct +i/-i                      | ±4000 V <sub>p</sub> | bursts of 5/50 ns<br>2.5/5 kHz<br>over 15 ms,<br>burst period<br>300 ms | 50 Ω          | 60 s positive,<br>60 s negative<br>transients per<br>coupling mode | yes      | B                        |
| Surges                           | IEC/EN 61000-4-5 | 3 <sup>4</sup> | +i/-i                             | ±2000 V <sub>p</sub> | 1.2/50 μs   | 2 Ω           | 5 pos. and 5 neg. surges   | yes      | B                        |
|                                  | EN 50155: 2001   | A <sup>5</sup> | +i/c, -i/c                        | ±1800 V <sub>p</sub> | 5/50 μs   | 100 Ω         |  | yes      | B                        |
|                                  |                  | B <sup>6</sup> | +i/c, -i/c                        | 8400 V <sub>p</sub>  | 0.05/0.1 μs   | 100 Ω         |  | yes      | B                        |
| RF Conducted immunity            | IEC/EN 61000-4-6 | 3              | +i/-i                             | 10 VAC<br>(140 dBμV) | AM modulated<br>80%, 1 kHz  | 50 Ω          | 0.15 to 80 MHz<br>150 Ω  | yes      | A                        |

<sup>1</sup> i = input, o = output, c = case (not with option Z)

<sup>2</sup> A = normal operation, no deviation from specification, B = temporary deviation from specs. possible.

<sup>3</sup> Corresponds to EN 50121-3-2:2000, table 9.1

<sup>4</sup> External components required; see fig. 4

<sup>5</sup> Corresponds to EN 50155:1995, waveform D

<sup>6</sup> Corresponds to EN 50155:1995, waveform G

## Electromagnetic Emissions

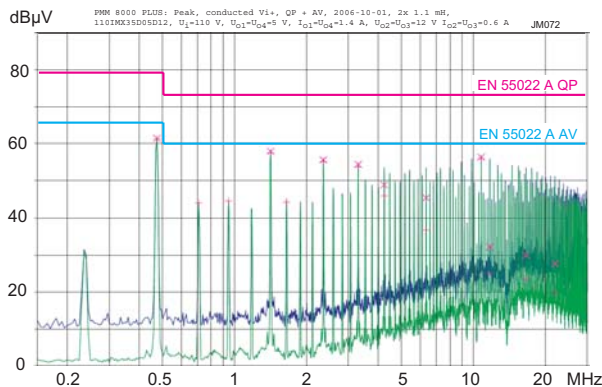

Fig. 14

Typ. disturbances (quasi-peak and average) at the input according to EN 55011/22, measured at  $V_{i\text{nom}}$  and  $I_{o\text{nom}}$  (110IMX35D05D12-8 with input choke  $2 \times 1.1$  mH).

Conducted emission according to EN 55011/55022, class A, can be achieved by adding an external common mode choke and an additional ceramic capacitor. The filter components should be placed as close as possible to the input of the converter; see figure 15.

Table 12: Input filter components

| Model    | Common mode choke<br>$L_1$ (Murata)  | Ceramic cap<br>$C_1$ |
|----------|--------------------------------------|----------------------|
| 20IMX35  | 70 $\mu$ H / 3.6 A, PLH10AN7003R6P2  | 4.7 $\mu$ F / 50 V   |
| 40IMX35  | 160 $\mu$ H / 2.1 A, PLH10AN1612R1P2 | 2.2 $\mu$ F / 100 V  |
| 70IMX35  | 290 $\mu$ H / 1.2 A, PLH10AN2911R2P2 | 1 $\mu$ F / 200 V    |
| 110IMX35 | 370 $\mu$ H / 1.0 A, PLH10AN3711R0P2 | 1 $\mu$ F / 200 V    |

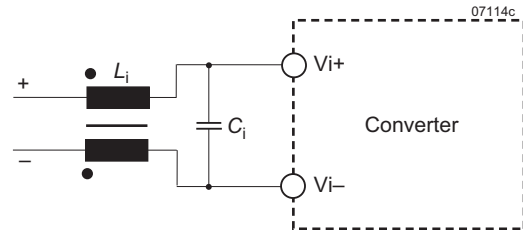

Fig. 15  
External filter circuitry

## Immunity to Environmental Conditions

Table 13: Mechanical and climatic stress

| Test method |  | Standard   | Test conditions  | Status                  |
|-------------|--|--|--|-------------------------|
| Cab         | Damp heat steady state   | IEC/EN 60068-2-78<br>MIL-STD-810D section 507.2                                      | Temperature: 40 $\pm$ 2 $^{\circ}$ C<br>Relative humidity: 93 $^{+2/-3}$ %<br>Duration: 56 days  | Converter not operating |
| --          | Salt mist test sodium chloride (NaCl) solution <sup>2</sup>      | EN 50155:2007 sect. 12.2.10 class ST3 <sup>2</sup>                                   | Temperature: 35 $\pm$ 2 $^{\circ}$ C<br>Duration: 48 h   | Converter not operating |
| Eb          | Bump (half-sinusoidal)   | IEC/EN 60068-2-29<br>MIL-STD-810D section 516.3                                      | Acceleration amplitude: 25 $g_n$ = 245 m/s <sup>2</sup><br>Bump duration: 6 ms<br>Number of bumps: 6000 (1000 in each direction)   | Converter operating     |
| Fc          | Vibration (sinusoidal)   | IEC/EN 60068-2-6<br>MIL-STD-810D section 514.3                                       | Acceleration amplitude: 0.35 mm (10 – 60 Hz)<br>5 $g_n$ = 49 m/s <sup>2</sup> (60 - 2000 Hz)<br>Frequency (1 Oct/min): 10 – 2000 Hz<br>Test duration: 7.5 h (2.5 h in each axis) | Converter operating     |
| Fh          | Random vibration broad-band (digital control) and guidance       | IEC/EN 60068-2-64  | Acceleration spectral density: 0.05 $g_n^2$ /Hz<br>Frequency band: 8 – 500 Hz<br>Acceleration magnitude: 4.9 $g_{rms}$<br>Test duration: 1.5 h (0.5 h in each axis)              | Converter operating     |
| Ea          | Shock (half-sinusoidal)  | IEC/EN 60068-2-27<br>MIL-STD-810D section 516.3                                      | Acceleration amplitude: 50 $g_n$ = 490 m/s <sup>2</sup><br>Bump duration: 11 ms<br>Number of bumps: 18 (3 in each direction)   | Converter operating     |
| --          | Shock  | EN 50155:2007 sect. 12.2.11<br>EN 61373 sect. 10, class B, body mounted <sup>1</sup> | Acceleration amplitude: 5.1 $g_n$<br>Bump duration: 30 ms<br>Number of bumps: 18 (3 in each direction)   | Converter operating     |
| --          | Simulated long life testing at increased random vibration levels | EN 50155:2007 sect. 12.2.11<br>EN 61373 sect. 8 and 9, Body mounted <sup>1</sup>     | Acceleration spectral density: 0.02 $g_n^2$ /Hz<br>Frequency band: 5 – 150 Hz<br>Acceleration magnitude: 0.8 $g_{n,rms}$<br>Test duration: 15 h (5 h in each axis)               | Converter operating     |

<sup>1</sup> Body mounted = chassis of a railway coach

<sup>2</sup> Models without option Z

## Temperatures

Table 14: Temperature specifications, valid for air pressure of 800 to 1200 hPa (800 to 1200 mbar)

| Temperature     |  | -8                       |                  | Unit |                  |
|-----------------|--|--------------------------|------------------|------|------------------|
| Characteristics | Conditions                                     | min                      | max              |      |                  |
| $T_A$           | Ambient temperature                            | Operational <sup>1</sup> | -40 <sup>3</sup> | °C   |                  |
| $T_C$           | Case temperature (without opt. Z) <sup>2</sup> |                          | -40 <sup>3</sup> |      | 85 <sup>1</sup>  |
| $T_{CZ}$        | Component temp. with opt. Z <sup>2</sup>       |                          | -40 <sup>3</sup> |      | 105 <sup>2</sup> |
| $T_S$           | Storage temperature                            | Non operational          | -55              | 105  |                  |

<sup>1</sup> See *Thermal Considerations*

<sup>2</sup> Temperature measurement point; see *Mechanical Data*

<sup>3</sup> Start-up at -55 °C

## Reliability

Table 15: MTBF at nom. load

| Model                           | Ground benign<br>40 °C | Ground fixed |         | Ground mobile<br>50 °C | Device hours <sup>1</sup> | Unit |
|---------------------------------|------------------------|--------------|---------|------------------------|---------------------------|------|
|                                 |                        | 40 °C        | 70 °C   |                        |                           |      |
| 40IMX35 (MIL-HDBK-217F, $T_C$ ) | 336 000                | 141 000      | 86 000  | 110 000                | 396 000                   | h    |
| 110IMX35 (Bellcore, $T_A$ )     | 1445 000               | 529 000      | 294 000 | 144 000                |                           |      |

<sup>1</sup> The device hours are based upon the IMX35 series field failure rate recorded between 2000 and 2005

## Mechanical Data

Dimensions in mm.

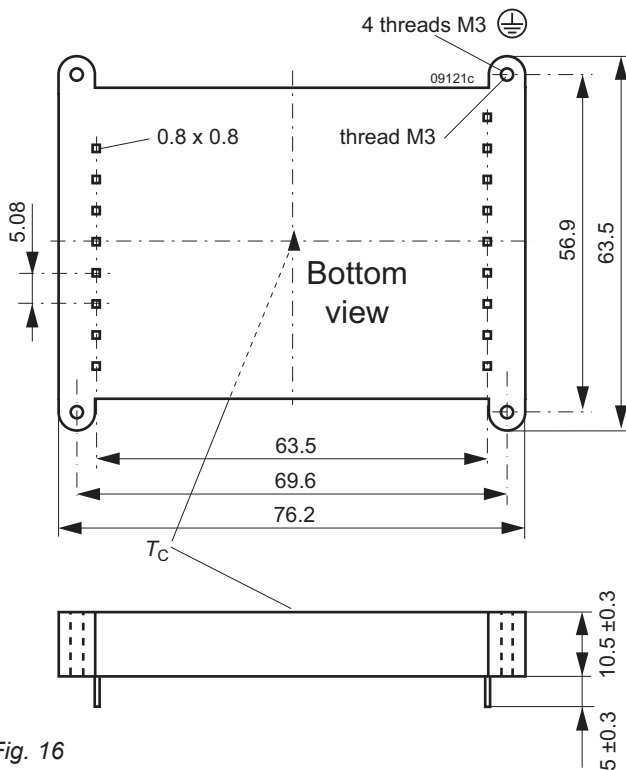

Fig. 16

Case IMX35 (Standard)

Material: Zinc; weight: approx. 67 g

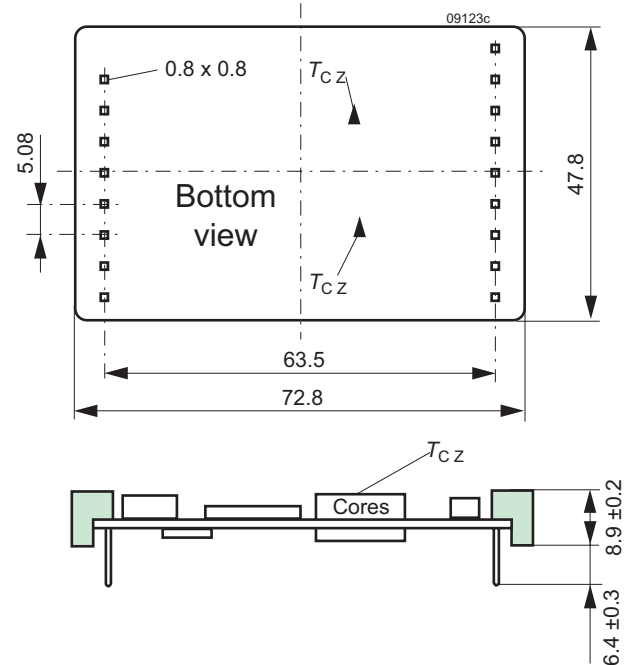

Fig. 17

Case IMX35 open frame (option Z)

Weight: approx. 43 g

## Safety and Installation Instructions

### Pin allocation

Table 16: Pin allocation

| Pin No. | Quadruple output     |
|---------|----------------------|
| 1       | PUL                  |
| 2       | Vi-                  |
| 3       | n.c.                 |
| 4       | Vi+                  |
| 5       | Trim or Trim1        |
| 6       | W                    |
| 7       | Ref                  |
| 8       | $\overline{SD}$ or i |
| 11      | Vo3-                 |
| 12      | Vo3+                 |
| 13      | Vo2+                 |
| 14      | Vo2-                 |
| 15      | Vo1-                 |
| 16      | Vo1+                 |
| 17      | Vo4+                 |
| 18      | Vo4-                 |
| 19      | n.c.                 |

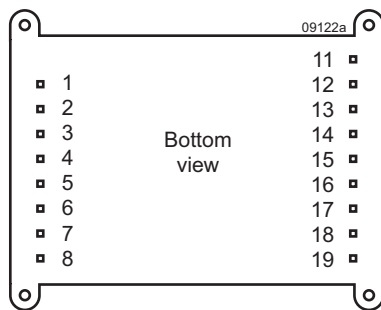

Fig. 18  
Footprint. The holes in the PCB should have a diameter of 1.5 mm.

### Installation Instructions

Installation of the converters must strictly follow the national safety regulations in compliance with the enclosure, mounting, creepage, clearance, casualty, markings, and segregation requirements of the end-use application.

Connection to the system shall be made via a printed circuit board with hole diameters of 1.5 mm for the pins.

The converters should be connected to a secondary circuit.

Do not open the converter.

Ensure that a converter failure (e.g., by an internal short-circuit) does not result in a hazardous condition.

### Input Fuse

To prevent excessive current flowing through the input supply line in case of a short-circuit in the converter, an external fuse should be installed in the non-earthed input line. We recommend a fast acting fuse specified in table 3.

### Standards and Approvals

All converters are safety-approved to IEC/EN 60950-1 and UL/CSA 60950-1 2<sup>nd</sup> Ed.

The converters have been evaluated for:

- Building-in
- Basic insulation input to output, based on their maximum input voltage
- Pollution degree 2 (not option Z)
- Connecting the input to a secondary circuit, which is subject to a maximum transient rating of 1500 V.

The converters are subject to manufacturing surveillance in accordance with the above mentioned standards.

CB scheme is available.

### Railway Applications

To comply with Railway standards, all components are coated with a protective lacquer (except for option Z).

### Protection Degree

The protection degree is IP 30 (not for option Z).

### Cleaning Liquids

In order to avoid possible damage, any penetration of cleaning fluids should be prevented, since the converters are not hermetically sealed.

However, open-frame models (option Z) leave the factory unlacquered; they may be lacquered by the customer, for instance together with the mother board. Cleaning liquids are not permitted – except washing at room temperature with isopropyl alcohol and de-ionized/distilled water (1 : 1).

**Note:** Cleaning liquids may damage the adhesive joints of the ferrite cores.

Table 17: Electric strength test voltages

| Characteristic                   | Input to (outputs+case) 20/40IMX35 <sup>1</sup> | Input to (outputs+case) 70/110IMX35 <sup>1</sup> | Outputs to case all models <sup>1</sup> | Between outputs all models | Unit |
|----------------------------------|---|--|---|----------------------------|------|
| Factory test >1 s                | 1.2   | 1.8  | 0.5                                     | 0.15 <sup>2</sup>          | kVAC |
| Equivalent DC voltage            | 1.5   | 2.5  | 0.7                                     | 0.2 <sup>2</sup>           | kVDC |
| Insulation resistance at 500 VDC | >100  | >100   | –                                       | –                          | MΩ   |

<sup>1</sup> For open-frame models (option Z), only the insulation input to outputs is tested.

<sup>2</sup> The test voltage between outputs is not applied as routine test.

### Isolation

The electric strength test is performed in the factory as a routine test in accordance with EN 50116, EN 60950, and UL

60950 and should not be repeated in the field. Power-One will not honor any warranty claims resulting from electric strength field tests.

### Options

#### i: Inhibit (Negative Shutdown Logic)

The outputs of the converter may be enabled or disabled by means of a logic signal (TTL, CMOS, etc.) applied to the inhibit (pin 8). If the inhibit function is not required the inhibit (pin 8)

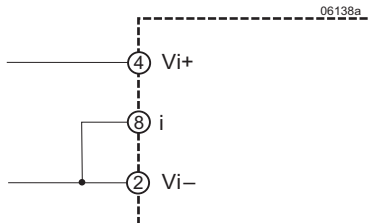

Fig. 19

If the inhibit pin is not used, connect it to Vi-.

should be connected to Vi- to enable the output (active low logic, fail safe).

Voltage at pin 8:

|                      |                                    |
|----------------------|------------------------------------|
| Converter operating: | -10 V to 0.8 V                     |
| Converter disabled:  | 2.4 V to 20 V or left open-circuit |

#### Z: Open Frame

For applications, where the protection by a housing is not necessary or in the case that the motherboard should be lacquered after fitting the converter.

**Note:** The converters shall not be exposed to cleaning processes, as this will damage the glue of the ferrite cores.

#### G: RoHS-6

Converters with a type designation ending by G are RoHS-compliant for all six substances.

**NUCLEAR AND MEDICAL APPLICATIONS** - Power-One products are not designed, intended for use in, or authorized for use as critical components in life support systems, equipment used in hazardous environments, or nuclear control systems without the express written consent of the respective divisional president of Power-One, Inc.

**TECHNICAL REVISIONS** - The appearance of products, including safety agency certifications pictured on labels, may change depending on the date manufactured. Specifications are subject to change without notice.

## X-ON Electronics

Largest Supplier of Electrical and Electronic Components

*Click to view similar products for [Isolated DC/DC Converters](#) category:*

*Click to view products by [Bel Fuse](#) manufacturer:*

Other Similar products are found below :

[ESM6D044440C05AAQ](#) [FMD15.24G](#) [PSL486-7LR](#) [PSR152.5-7IR](#) [Q48T30020-NBB0](#) [AVO240-48S12B-6L](#) [AVO250-48S28B-6L](#) [NAN-0505](#) [HW-L16D](#) [JAHW100Y1](#) [217-1617-001](#) [22827](#) [SPB05C-12](#) [SQ24S15033-PS0S](#) [18952](#) [19-130041](#) [CE-1003](#) [CE-1004](#) [GQ2541-7R](#) [PSE1000DCDC-12V](#) [RDS180245](#) [MAU228](#) [419-2065-201](#) [449-2075-101](#) [J80-0041NL](#) [V300C24C150BG](#) [419-2062-200](#) [419-2063-401](#) [419-2067-101](#) [419-2067-501](#) [419-2068-001](#) [DCG40-5G](#) [DFC15U48D15](#) [449-2067-000](#) [XGS-0512](#) [XGS-1205](#) [XGS-1212](#) [XGS-2412](#) [XGS-2415](#) [XKS-1215](#) [033456](#) [NCT1000N040R050B](#) [SPB05B-15](#) [SPB05C-15](#) [SSQE48T25025-NAA0G](#) [L-DA20](#) [HP3040-9RG](#) [HP1001-9RTG](#) [NVD0.4YJJ-M6G](#) [XKS-2415](#)