

Powerex, Inc., 173 Pavilion Lane, Youngwood, Pennsylvania 15697 (724) 925-7272
<http://www.pwr.com>

POW-R-BLOK™ Dual SCR Isolated Module 150 Amperes / 800 to 1800 Volts

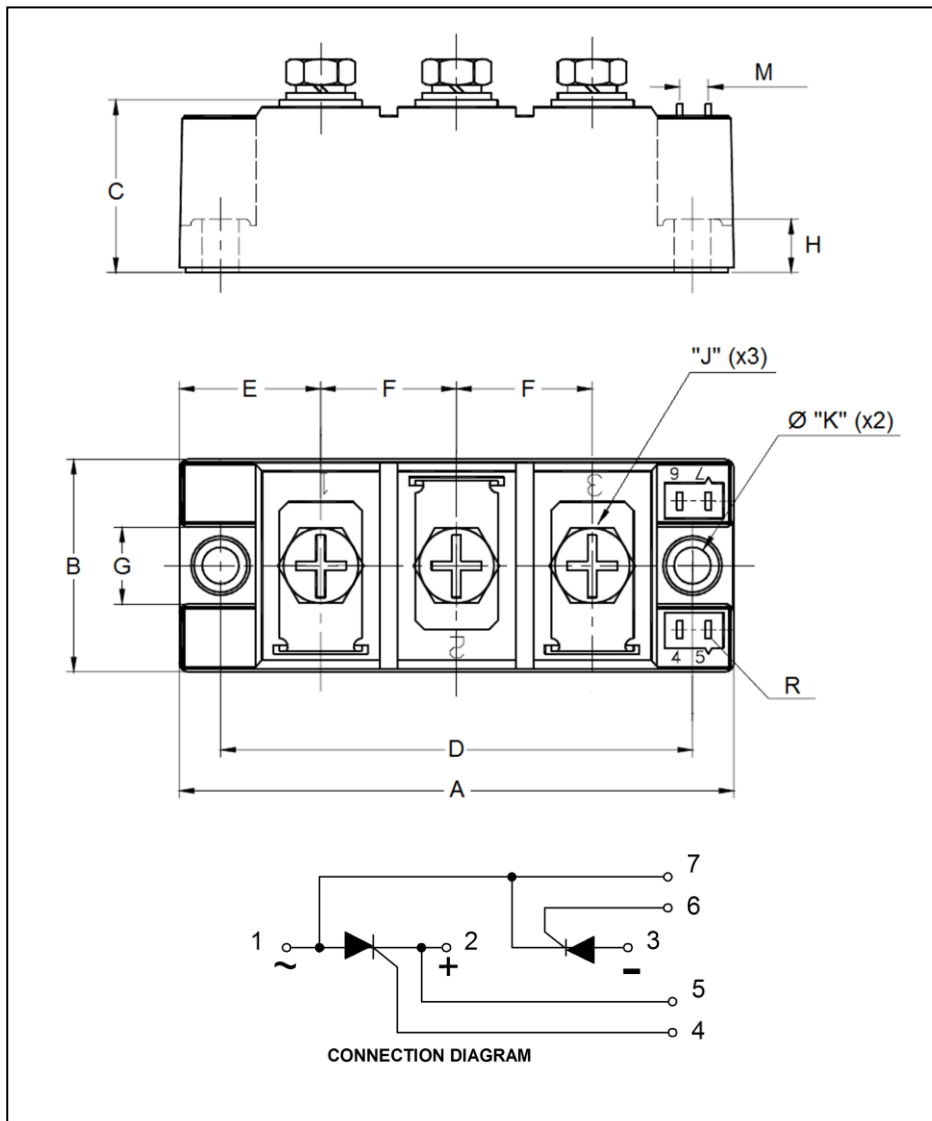

Description:

Powerex Dual SCR Modules are designed for use in applications requiring phase control and isolated packaging. The modules are isolated for easy mounting with other components on a common heatsink.

Features:

- Electrically Isolated Heatsinking
- Compression bonded construction
- Low Thermal Impedance for Improved Current Capability
- Quick Connect Gate Terminal with Provision for Keyed Mating Plug
- RoHS Compliant
- UL Recognized (E78240)

Benefits:

- No Additional Insulation Components Required
- Easy Installation
- No Clamping Components Required
- Reduce Engineering Time

Applications:

- Bridge Circuits
- AC & DC Motor Drives
- Battery Supplies
- Power Supplies
- Large IGBT Circuit Front Ends
- Lighting Control
- Heat & Temperature Control
- Welders

Outline Dimensions

Dimension	Inches	Millimeters
A	3.70	94
B	1.34	34
C	1.15	29.2
D	3.15	80
E	0.94	24
F	0.91	23
G	0.51	13
H	0.35	9
J	M6	M6
K	0.24	6.2
M	0.19	4.9
R	0.03 X 0.11	2.8 X 0.8

Note: Dimensions are for reference only.

Ordering Information:

Select the complete nine digit module part number from the table below.
 Example: CD631615C is a 1600Volt, 150 Ampere Dual SCR Isolated POW-R-BLOK™ Module

Type	Voltage Volts (x100)	Current Amperes	Version
CD63	08	15 (150 A)	C
	10		
	12		
	14		
	16		
	18		

Absolute Maximum Ratings

Characteristics	Conditions	Symbol		Units
Repetitive Peak Forward and Reverse Blocking Voltage		V_{DRM} & V_{RRM}	800 to 1800	V
Non-Repetitive Peak Reverse Blocking Voltage (t < 5 msec)		V_{RSM}	$V_{RRM} + 100$	V
RMS Forward Current	180° Conduction, $T_C=86^\circ\text{C}$	$I_{T(RMS)}$	235	A
Average Forward Current	180° Conduction, $T_C=86^\circ\text{C}$	$I_{T(AV)}$	150	A
Peak One Cycle Surge Current, Non-Repetitive	50 Hz, 60% V_{RRM} reapplied, $T_j=125^\circ\text{C}$	I_{TSM}	5400	A
I^2t for Fusing for One Cycle	50 Hz, 60% V_{RRM} reapplied, $T_j=125^\circ\text{C}$	I^2t	149,000	A ² sec
Maximum Rate-of-Rise of On-State Current, Repetitive	$T_j=125^\circ\text{C}$, $I_{TM}=320\text{A}$, $I_G=1.5\text{A}$, $T_r < 0.5\mu\text{s}$	di/dt	100	A/ μs
Operating Temperature		T_j	-40 to +125	°C
Storage Temperature		T_{stg}	-40 to +125	°C
Max. Mounting Torque, M6 Mounting Screw on Terminals			53 6	in.-Lb. Nm
Max. Mounting Torque, Module to Heatsink			53 6	in.-Lb. Nm
Module Weight, Typical			320 0.71	g lb
V Isolation @ 25C	$T_j=25^\circ\text{C}$, 1 minute	V_{rms}	2500	V

Information presented is based upon manufacturers testing and projected capabilities.
This information is subject to change without notice.
The manufacturer makes no claim as to the suitability of use, reliability, capability,
or future availability of this product.

Electrical Characteristics, $T_J=25^\circ\text{C}$ unless otherwise specified

Characteristics	Symbol	Test Conditions	Min.	Max.	Units
Repetitive Peak Forward Leakage Current	I_{DRM}	At V_{DRM} , $T_J=125^\circ\text{C}$		25	mA
Repetitive Peak Reverse Leakage Current	I_{RRM}	At V_{RRM} , $T_J=125^\circ\text{C}$		25	mA
Peak On-State Voltage	V_{TM} / V_{FM}	$I_{TM} / I_{FM}=480\text{A}$		1.60	V
Threshold Voltage, Low-level	$V_{(TO)1}$	$T_J = 125^\circ\text{C}$, $I = 16.7\% \times \pi I_{T(AV)}$ to $\pi I_{T(AV)}$		0.8	V
Slope Resistance, Low-level	r_{T1}			1.69	m Ω
Minimum dV/dt	dV/dt	Exponential to $2/3 V_{DRM}$ $T_J=125^\circ\text{C}$, Gate Open	800		V/ μs
Gate Trigger Current	I_{GT}	$T_J = 25^\circ\text{C}$, $V_D=12\text{V}$, $I_A= 1\text{A}$		150	mA
Gate Trigger Voltage	V_{GT}	$T_J = 25^\circ\text{C}$, $V_D=12\text{V}$, $I_A= 1\text{A}$		2.5	Volts
Non-Triggering Gate Voltage	V_{GDM}	$T_J=125^\circ\text{C}$, $V_D=V_{DRM}$		1.0	Volts
Non-Triggering Gate Current	I_{GDM}	$T_J=125^\circ\text{C}$, $V_D=V_{DRM}$		30	mA
Holding Current	I_H	$T_J=25^\circ\text{C}$	150	(Typical)	mA

Thermal Characteristics

Characteristics	Symbol		Max.	Units
Thermal Resistance, Junction to Case DC Operation	$R_{\theta J-C}$	Per Junction, both conducting	0.17	$^\circ\text{C/W}$
Thermal Resistance, Case to Sink Lubricated	$R_{\theta C-S}$	Per Module	0.08	$^\circ\text{C/W}$

Maximum On-State Forward Voltage Drop
 (T_j = 125 °C)

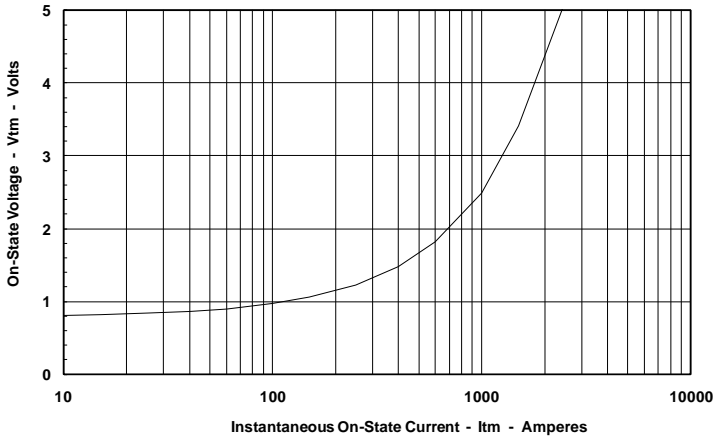

Maximum Transient Thermal Impedance
 (Junction to Case)

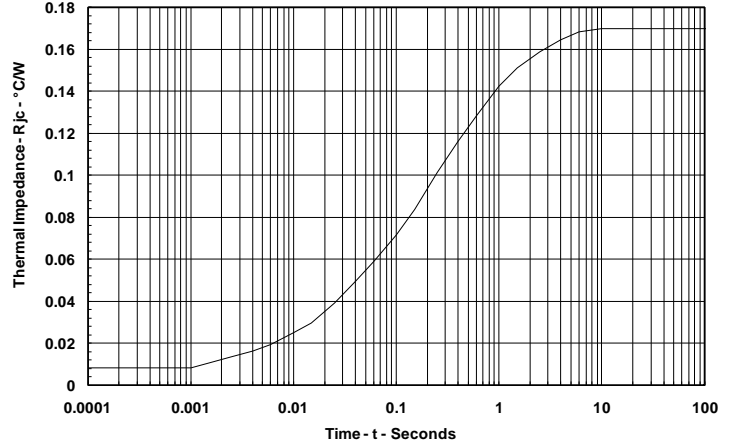

Maximum On-State Power Dissipation
 (Sinusoidal Waveform)

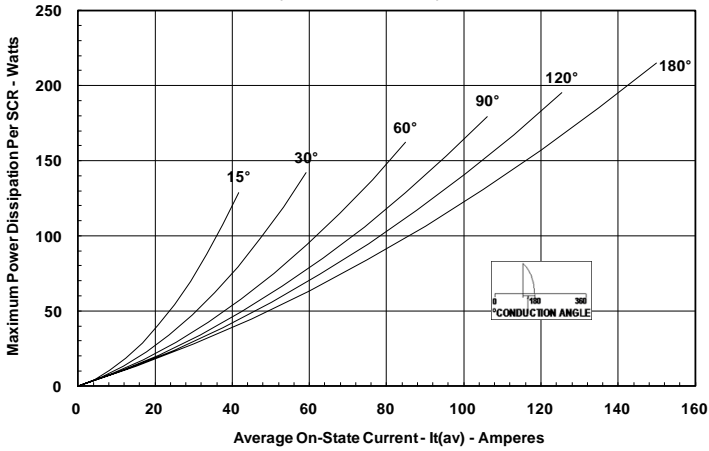

Maximum Allowable Case Temperature
 (Sinusoidal Waveform)

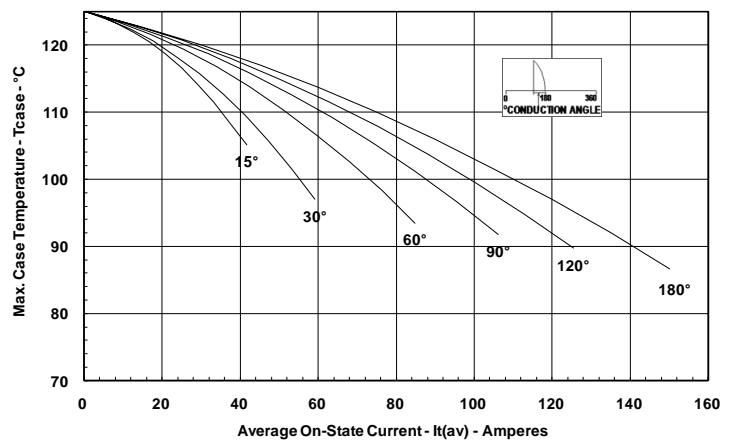

Maximum On-State Power Dissipation
 (Rectangular Waveform)

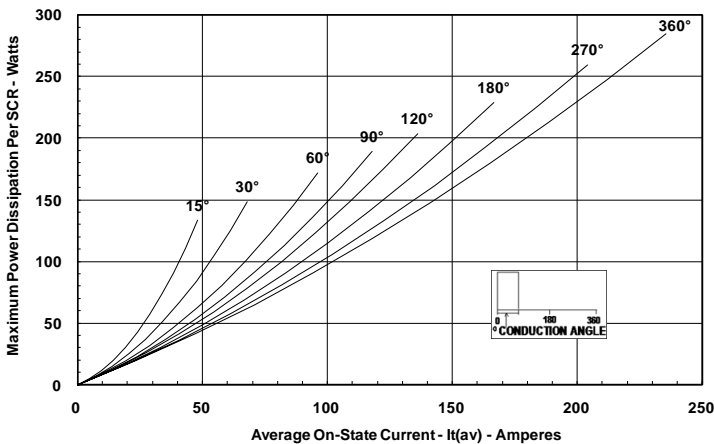

Maximum Allowable Case Temperature
 (Rectangular Waveform)

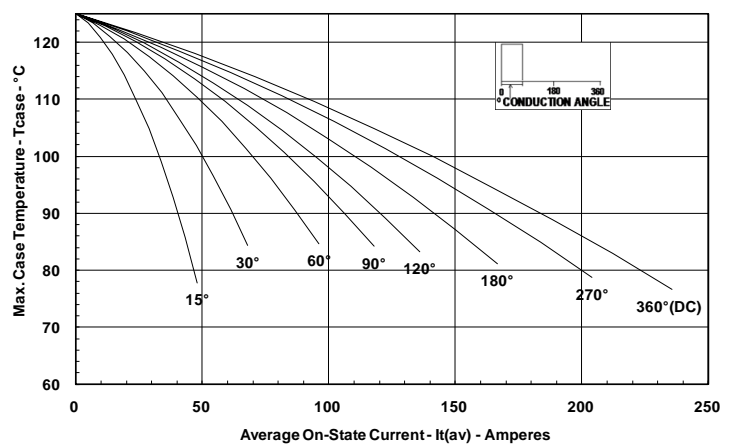

X-ON Electronics

Largest Supplier of Electrical and Electronic Components

Click to view similar products for [SCRs](#) category:

Click to view products by [Powerex](#) manufacturer:

Other Similar products are found below :

[NTE5428](#) [NTE5448](#) [NTE5457](#) [NTE5511](#) [T1500N16TOF VT](#) [T720N18TOF](#) [T880N14TOF](#) [T880N16TOF](#) [TS110-7UF](#) [TT104N12KOF-A](#)
[TT104N12KOF-K](#) [TT162N16KOF-A](#) [TT162N16KOF-K](#) [TT330N16AOF](#) [VS-16RIA100](#) [VS-22RIA20](#) [VS-2N5206](#) [VS-2N685](#) [VS-](#)
[40TPS08A-M3](#) [VS-ST230S12P1VPBF](#) [057219R](#) [CLB30I1200HB](#) [T1190N16TOF VT](#) [T1220N22TOF VT](#) [T201N70TOH](#) [T830N18TOF](#)
[TD92N16KOF-A](#) [TT250N12KOF-K](#) [VS-2N692](#) [VS-2N689](#) [VS-25RIA40](#) [VS-16RIA120](#) [VS-10RIA120](#) [VS-30TPS08PBF](#) [NTE5427](#)
[NTE5442](#) [VS-2N690](#) [VS-ST300S20P0PBF](#) [TT251N16KOF-K](#) [VS-22RIA100](#) [VS-16RIA40](#) [CR02AM-8#F00](#) [VS-ST110S12P0VPBF](#)
[TD250N16KOF-A](#) [VS-ST110S16P0](#) [VS-10RIA10](#) [VS-16TTS08-M3](#) [TS110-7A1-AP](#) [T930N36TOF VT](#) [T2160N24TOF VT](#)