



Pololu Aluminum Scooter Wheel Adapter for 6mm Shaft



Overview

This compact aluminum adapter assembly makes it easy to use many common scooter, skateboard, and inline skate wheels with motors with 6 mm diameter output shafts, enabling many more wheel options for your project. It works with most wheels that are compatible with standard 608 bearings.

The adapter consists of two main components: a machined piece with threaded holes that mounts to the motor shaft using the two included M4 set screws, and a flat washer that clamps the wheel to the machined piece using the three included 14 mm M3 screws. The washer has a hole in the center that allows the motor's output shaft to optionally pass through for added flexibility in wheel placement on the shaft, and the low profile of the machined piece lets it work with wheels that have as little as 6 mm of space between where the 608 bearings normally fit.

We also carry versions of this adapter that works with 4 mm motor shafts and 5 mm motor shafts.

Using the adapter

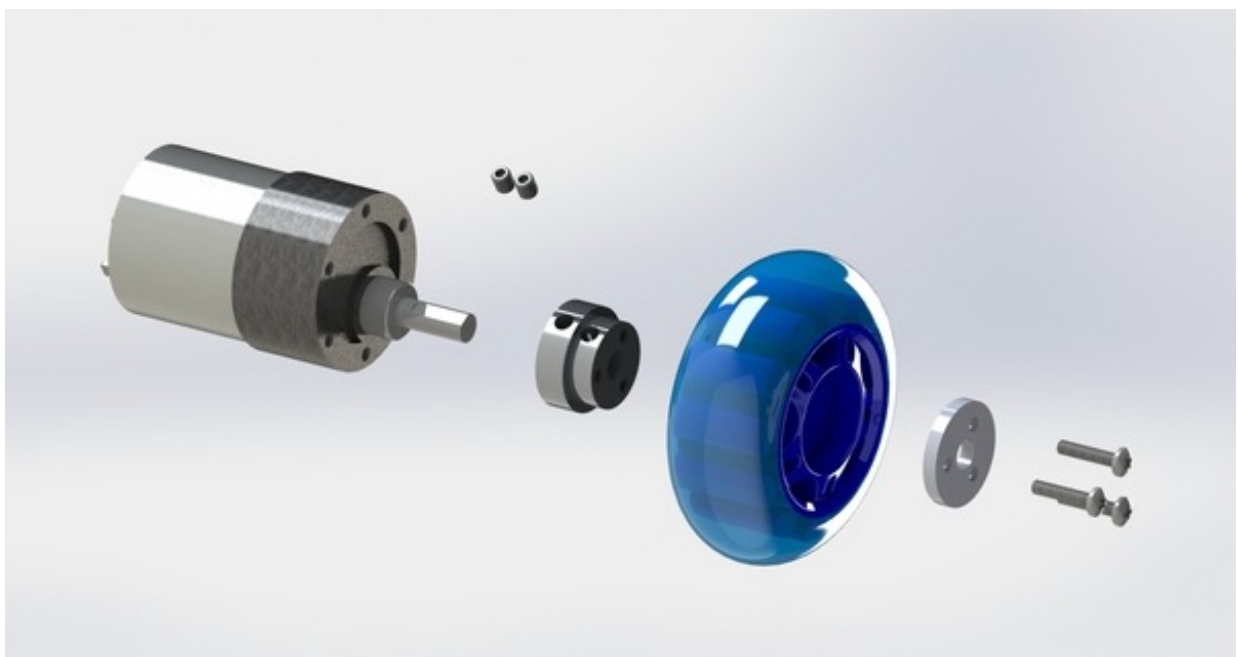

Exploded view of the scooter wheel adapter assembly with a gearmotor and scooter wheel.

The adapter is straightforward to use when assembled in the proper order. First, slide the threaded shaft mount onto your motor's output shaft with the narrower part facing away from the motor and

tighten the set screws. (If your motor has a D-shaft, make sure you align the set screws with the flattened portion of the shaft.) Once this piece is secured, press the wheel directly onto it. Next, align the holes of the washer with the threaded holes of the shaft mount and press the washer into the recess on the other side of the wheel. The diameter of the washer is slightly smaller than that of the threaded shaft mount, so the orientation of the washer should be easier to adjust if the holes are not quite aligned. Finally, insert and tighten the M3 machine screws, making sure to tighten them evenly rather than one at a time.

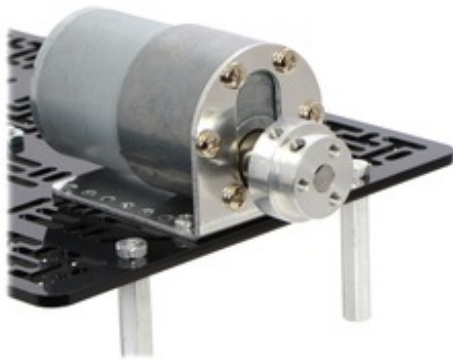

The machined piece of the 6 mm scooter wheel adapter mounted to the output shaft of a 37D mm gearmotor.



A 37D mm gearmotor connected to a scooter wheel by the 6 mm scooter wheel adapter.



Note: For some wheels, it might be difficult to push the washer into the wheel with your bare hands. In such cases, an alternative approach is to initially use longer M3 screws to engage the threads of the machined piece. You can then tighten the parts together, making sure to tighten the three screws evenly so that the washer stays parallel to the threaded piece. When the longer M3 screws cannot be tightened further, you can replace them with the included 14 mm screws and finish the assembly.

Dimensions

This adapter is intended to work with motors with 6 mm diameter output shafts, and it fits most wheels that are compatible with standard 608 ball bearings. Please see the dimensions below to confirm that it will work with a particular wheel.

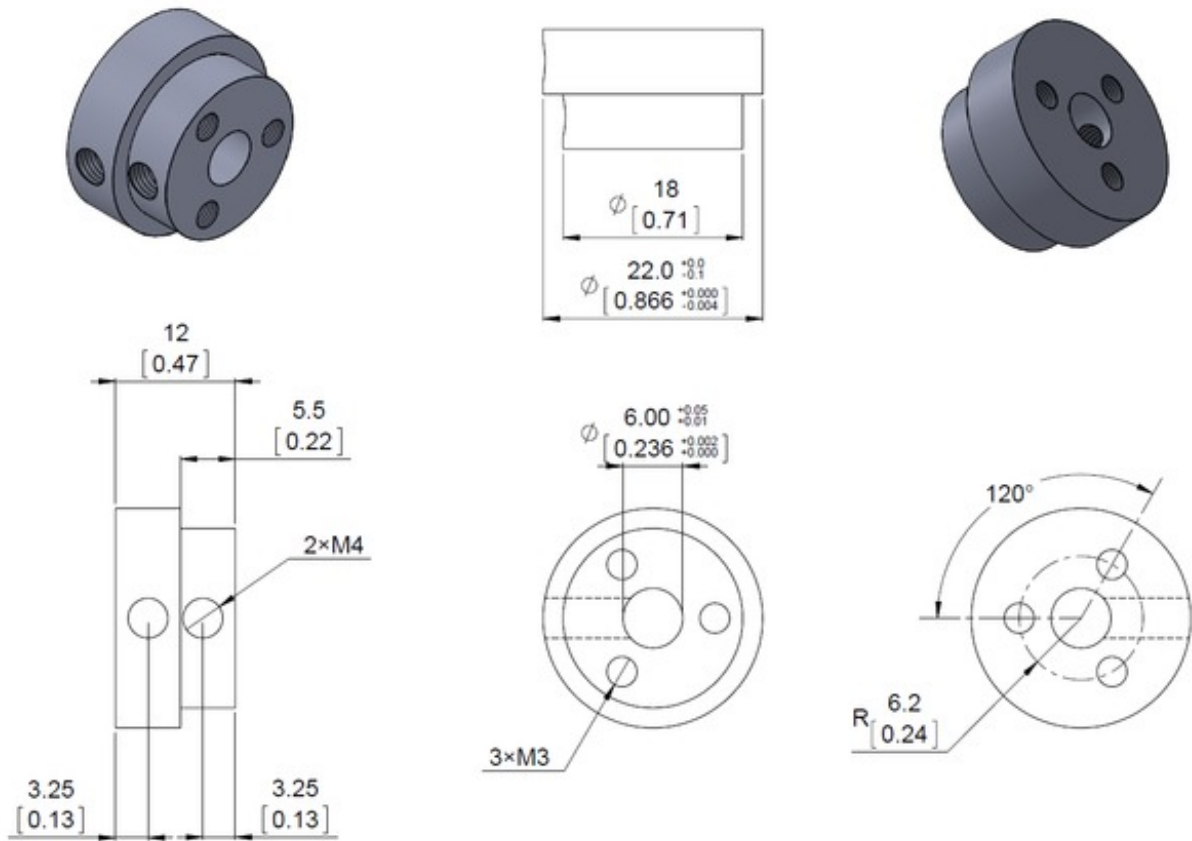

Mechanical drawing of the Pololu aluminum scooter wheel adapter threaded mount for 6 mm shafts. Units are mm over [inches].

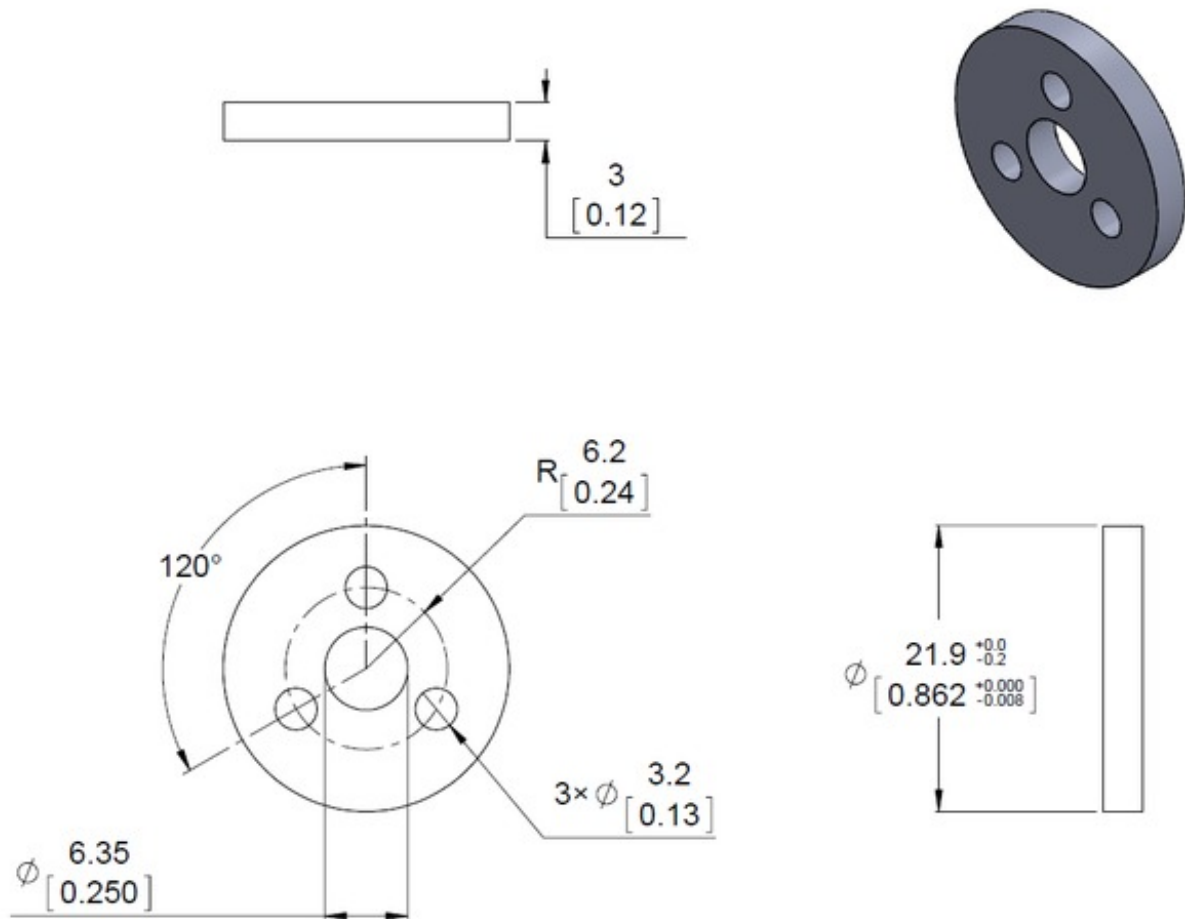

Mechanical drawing of the Pololu aluminum scooter wheel adapter flat washer. Units are mm over [inches].

These drawings are also available as a downloadable pdf (184k pdf).

[Documentation on producer website.](#)

X-ON Electronics

Largest Supplier of Electrical and Electronic Components

Click to view similar products for [Accessories for Robotics and RC category](#):

Click to view products by [Pololu manufacturer](#):

Other Similar products are found below :

[56T705](#) [015-9516-002](#) [01.001.6453.0](#) [641763-8](#) [CW106-01X](#) [CW30101A](#) [CW31701A](#) [D2041839](#) [70.352.0628.0](#) [73.353.4028.1](#) [FB22001A](#)
[FB30601A](#) [9009030000](#) [9501](#) [121587-0026](#) [1218510-1](#) [1218629-4](#) [1218630-4](#) [1261000A00M001](#) [128-26-5](#) [RFI77-14](#) [1367251-2](#) [14](#) [1-](#)
[449604-1](#) [1460g4](#) [1470g4](#) [DV0PM20034](#) [MS27488-16-1](#) [MS3057-12A W/B](#) [MS3057-8A-624](#) [MS600-2-XP-1A](#) [MS-602-GEE-14-07C](#)
[MS603-12-01A](#) [MS90376-14R](#) [MS90376-16RB](#) [MTB1-11PH3](#) [1676610000](#) [1A9224 REV A](#) [210-115](#) [CA20L22](#) [2227383-1](#) [225-0090-000](#)
[225-0098-000](#) [KA-89-82](#) [CB20201X](#) [KC-89-104](#) [CB30601A](#) [CB31201A](#) [236-600](#) [CBC120210-752](#)