



F&F Filipowski sp. j.
ul. Konstytucyjna 79/81
95-200 Pabianice, POLAND
tel/fax 48 42 2270971
e-mail: fif@fif.com.pl

CLG-03 WORKING TIME METERS



www.fif.com.pl

F&F products are covered by an 24 months warranty from date of purchase

PURPOSE

CLG-03 is a programmable, multi-function electronic meter, enabling the counting of working hours of the connected devices or systems in 1 to 999 999 range, corresponding to 114 years of operation. Working time is counted according to an individual program, set by the user. After reaching the limiting value, the meter will configure itself according to individual user's needs.

FUNCTIONS

- control panel, enabling programming and the monitoring of device operation
- T input for DC signal and AC signal 50 Hz
- counting time upwards without threshold value
- 'downward' counting mode to the selected value with zero value

The bottom line of the display is an indication of the current meter. The unit is meter hours. Digit after the decimal point, depending on the format, might indicate tenths of hours (6min Format: 0.1 = 6min., For example, 12.4 = 12godz.24min.) Or counted the number of consecutive 10min. hours (10 minutes Format: 0.1 = 10min., for example, 12.4 = 12godz.40min., but when counting takes place in the 0.1 ÷ 0.6 on the value of 0.6 is about 1 meter jump unit (hour).

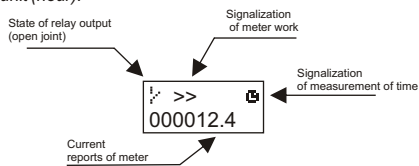

After reaching the set value until the display shows STOP message, and highlighting the display flashes three times. This situation is shown in the figure below.

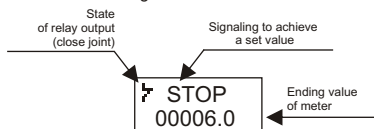

Button functions

After the entry into programming mode the meter, through the display and clear the configuration menu, you can easily set all the parameters of the meter.

- MENU** - to move the programming mode of the system. If the meter is in edit mode of numeric parameter, press the button to jump to the next edition of the numb

- counting working time with high state (constant voltage) at the T input
- counting working time between two pulses given at the T input
- counting time upwards to the selected threshold value
- external RESET input
- relay output signaling the preset meter state (contact 1C/O 8A)
- relay action selection: pulse with set time length; ON→ OFF or OFF→ ON state change
- local and total meter state memory after supply failure
- limiting access to program menu using PIN code- setting display illumination mode
- program menu in three languages: Polish, English or Russian

Description of display and control panel

For operating and programming the meter CLG-03 is used mounted on the front control panel. It consists of a double, eight-digit alphanumeric display, and placed underneath the five key keyboard

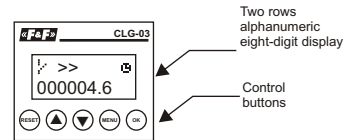

Work of meter is indicayed by pulsating symbol >> located in the top row. Measurement of time is symbolized by appearing in the right corner of the upper line of the symbol clock. On the left side there is a symbol representing the state of output relay

- UP and DÓWN** - to move between each menu items, and to increase or decrease the value of the parameter being edited.
- OK** - entrance to the selected menu item, and enter changes.
- RESET** - to reset the current cycle of meter. The programming mode allows you to go back to the higher-level menus. If the RESET button is pressed while editing a parameter, the program comes from the editing mode without saving changes.

FUNCTIONING

Measurement of the duration of the high

In this mode, the user specifies a set value of time the meter counts all the time in which the input is given gates high state. The emergence of the low mileage makes the freeze, and it will restart when the input again appears high state. Achieving the set value is indicated by a change in the relay outputs (NO contact closure), and stop counting the time. At the same time the display shows STOP and highlighting the display flashes three times. Start a new cycle is possible only after the timer expires, the level of the control panel (by pressing the RESET button), or via an external reset input. To protect the system against accidental erasure of the meter, a zero signal is activated only after three seconds after you press the RESET button or the input signal is given for resetting. This does not include the loop mode, where the reset is only possible through an external signal to a reset, and the pulse duration can not be less than ten seconds.

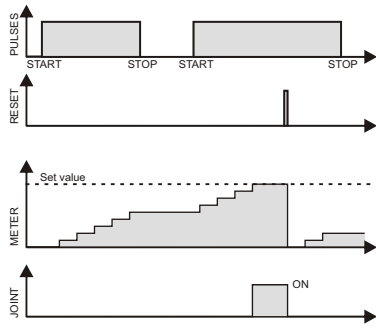

Measurement of time between two pulses

In this mode, the counter measures the time between two successive pulses given at the entrance gate. The advent of pulsed positive (transition from low to high) starts counting time. Re-emergence of such an impulse to stop counting and the freezing of the meter. Another positive trigger starts counting continued. When the meter reaches the preset by the user of a change in the state of relay outputs (NO, contact closure), and stop counting the time. At the same time the display shows STOP and highlighting the display flashes three times.

Start a new cycle is possible only after the timer expires, the level of the control panel (by pressing the RESET button), or via an external reset input. To protect the system against accidental erasure of the counter, a zero signal is activated only after three seconds after you press the RESET button or from the input signal is given zero.

This doesn't include the loop mode, where the reset is only possible through an external signal to a zero, and the pulse duration can not be less than ten seconds

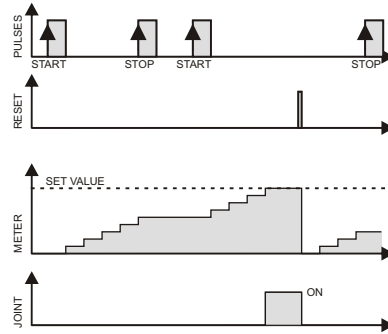

ATTENTION!

Meter retains its current state after turning off the power supply voltage. This means that after re-power the system restore all the settings are both meter and meter indication and relay output status.

Programming of meter

Meter configuration is performed using a control panel with a keyboard and display. Entry to the programming mode the meter is done by pressing the MENU button.

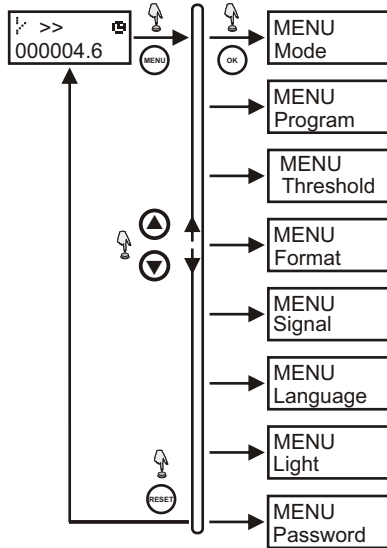

To move between menu items are UP and DOWN buttons. To enter the selected menu item, press the OK button. Exit to menu provides a superior level of the RESET button.

Menu -> Mode

Mode menu lets you select the basic mode of operation, ie whether the meter will measure the duration of the high state at the entrance gate or measured is the time between two consecutive pulses. Scheme of Menu ->.

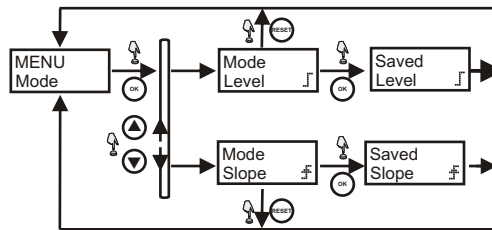

Course of conduct in the definition mode is as follows:

- 1) By the button MENU pass to main menu of meter.
- 2) By buttons UP or DOWN select item Menu -> Mode and press OK.
- 3) Then shows Menu -> Mode included two position Mode -> Level and Mode -> Slope. Level means that the meter will measure the duration of the high state at the entrance bramkującym.
- Slope will be counted the time between successive pulses on the input given gate. UP and DOWN buttons to select the appropriate option and click OK. Approval of the selected option is indicated by displaying the message saved with the name of the selected parameter
- 4) From edition mode can move out by button RESET. It cause return to main menu, without save all put changes..

Menu -> Program

The menu allows you to specify whether the meter will be tracked from time zero to a preset threshold, counting from the threshold to zero, or tracked without any restrictions from zero upward until it reaches the counter overflow.

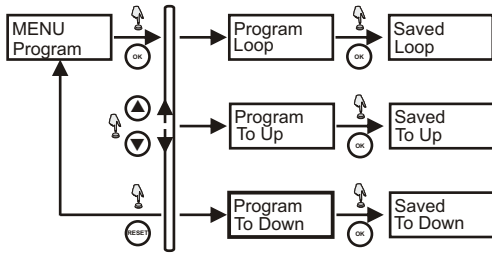

Course of conduct when determining the rounding off is as follows:

- 1) By button MENU pass to main menu.
- 2) By buttons UP or DOWN select item Menu -> Program and press button OK.
- 3) Then shows Menu -> Program included follow items:
 Program -> Loop mode in which the counting time from zero up without regard to the setpoint. Meter measures the time until the meter overflows.
 Program -> To UP meter will be time to count up from zero to a specified (parameter Menu -> Threshold).
 Program -> To DOWN zliczenie realizowane będzie w dół, zaczynając od ustalonej wartości progowej (parameter Menu -> Threshold), and ending with zero. By buttons UP and DOWN select correct option and press button OK. Enter of the selected option is indicated by displaying the message: Saved with the name of the selected parameter.

- 4) By buttons UP or DOWN set correct value digit of edited position. To pass to edit digit on the next position press button MENU.
- 5) In this way, you need to set all digits of set value and enter the new value.
- 6) Saving changes is indicated by a message SAVED, after that program back to Menu -> Threshold.
- 7) To exit the menu without saving the changes, at any time by editing press the RESET button.

ATTENTION!

Setting a new threshold resets the current timer. There is no impact on the timer in the program loop.

Menu -> Format

Format menu allows you to specify the time format displayed by the meter. The unit is meter hours. The lowest value indicated on the display is 0.1. Cyfra decimal, depending on the format, might indicate tenths of hours (6min Format: 0.1 = 6min., For example, 12.4 = 12godz.24min.) Or counted the number of consecutive 10min. hours (10 minutes Format: 0.1 = 10min., for example, 12.4 = 12godz.40min., the counting takes place in the 0.1 ÷ 0.6 on the value of 0.6 is about 1 meter jump unit (hour).

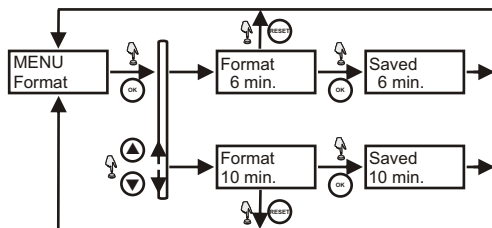

- 4) From edit mode you can move out by pressing the RESET button. This withdrawal of the parent menu without saving changes.

Menu -> Threshold

The threshold parameter determines the threshold which will be counted at the time of the selected program to the top, or from which starts the timer at the bottom on the chosen program. The threshold parameter has no effect on the work counter, where the program was chosen loop. Threshold can be set to the nearest full hour

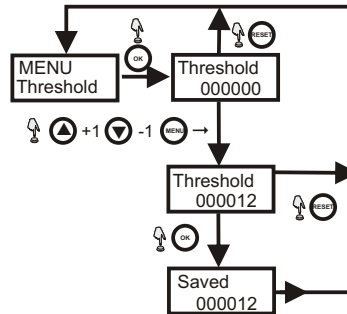

Proceedings in determining the threshold value is as follows:

- 1) By button MENU pass to main menu.
- 2) By buttons UP or DOWN select item Menu -> Threshold and press button OK.
- 3) The bottom line will show the current setpoint. Edited currently digit is signaled by the pulsating cursor.

Proceedings in determining the time display format is as follows:

- 1) By button MENU pass to main menu.
- 2) By buttons UP and DOWN select item Menu -> Format and press OK.
- 3) Then shows Menu -> Format included follow items:
 Format -> 6min.
 Format -> 10min.
 By buttons UP and DOWN select correct option and press button OK. Enter chosen option is indicated by display message. Saved by the name of the selected parameter.
- 4) To exit the menu without saving the changes, at any time by editing press the RESET button

Menu -> Signal

Menu specifies the type of signal is connected to the input signal and gate reset. There are two options here, the signal stable (DC) and alternating signal (AC).

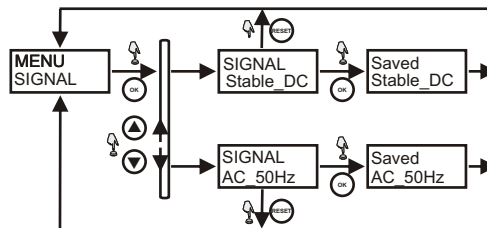

To define the type of input signal is needed:

- 1) Pass to menu by pressing a button MENU.
 - 2) By buttons UP or DOWN select Menu -> Signal and press OK.
 - 3) The will show Menu -> Signal included follow items:
Signal -> Stable_DC To input of meter will be give permanent voltage. System will react in this case to set signal slope, or achieve a high state.
Signal -> AC_50Hz To input of meter will be give analog voltage with frequency 50 Hz. In this case the system will react to the fact that the emergence of an alternating voltage at the terminals of control.
- By buttons UP or DOWN select correct option and press button OK. Remember the new parameter value is indicated by displaying the message. Saved with new parameter value, after that program back to Menu -> Signal.
- 4) To exit the parameter editing without saving changes, press the RESET button.

Menu -> Language

This parameter allows to specify what language you'll see the messages. To select messages are in Polish, English and Russian. Menu chart is shown in the figure below.

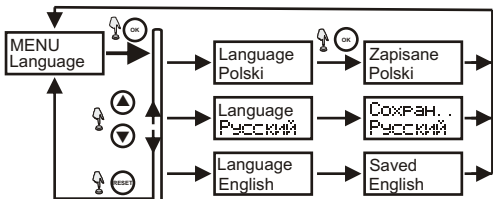

- 3) You will see the Menu -> Light containing the following items:
Light -> At constant - The display will be constantly illuminated. Signaling reaches the setpoint will meter that the display will flash three times, then returns to the highlight state. Light -> button - The display will be highlighted only when you press any button and 60 seconds after him. In case of the meter setpoint highlighting blinks three times then turns off. UP and DOWN buttons to select the correct option and click OK. Remember the new parameter value is indicated by displaying the message, Saved with the new value of the parameter, then the program returns to the Menu -> Light.
- 4) To exit the parameter editing without saving changes, press the RESET button.

System -> Password

Password parameter can be used to restrict access by unauthorized users to meter menu. The password is the number of accepting values from 0 to 999, but set the password to 0 removes the security of meter. Setting the password other than zero introduces a meter in the secure mode. To set a password you need:

1. By button MENU pass to main menu.
2. By buttons UP or DOWN pass to Menu > System and enter by OK.
3. By buttons UP or DOWN select command System > Password and press a button OK.
4. Meter is now in the mode of implementation of the new PIN, which is signaled by a message New PIN. Password is entered in the form of overt and baseline is the previous value of the password.
5. By buttons UP or DOWN set the appropriate value of sequential numbers, and use the MENU button, you can go to the next edition of the numbers. After entering all the required numbers to confirm a new PIN by pressing the OK button.
6. To exit the editing mode without saving your password, press the RESET button.

To change a language of message you need:

- 1) By button MENU pass to main menu.
- 2) By buttons UP or DOWN select item Menu > Language and enter by OK.
- 3) From list by buttons UP or DOWN select correct item and enter by OK. Confirmation of the change of language will appear in the new selected language.
- 4) To exit the option to choose the language without any changes, press the RESET button.

Menu->Light

This parameter allows to specify a way of highlight a meter display. You can set the highlight permanently highlight, or highlighting only for 60 seconds after you press any button.

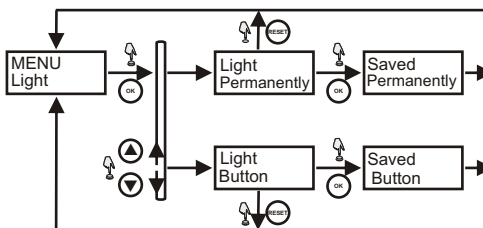

To determine how the highlight you need:

- 1) Pass to menu by pressing a button MENU.
- 2) By buttons UP or DOWN select Menu -> Light and press OK.

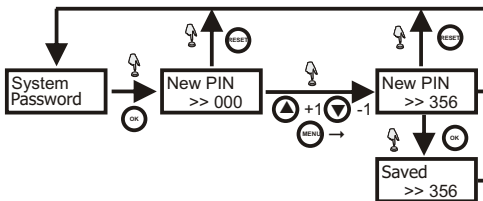

After setting the password to access the menu meter is protected against unauthorized access. This state is signaled by a key symbol on the display positioned in the right top of the display.



From this moment to enter the configuration menu of meter when you press MENU first enter the correct PIN.

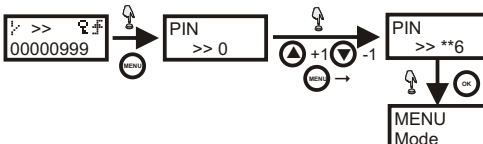

The PIN is introduced here as classified. That means you edit the figure is visible, while the remaining two digits are hidden under asterisk. If you enter an incorrect PIN number is displayed bad PIN, then the meter will return to display the current value of the meter.

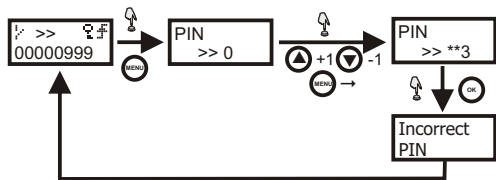

The system allows you to enter the PIN number, any number of times, preventing the device blocked by too many errors at the administration password

After entering the password the user has full access to the menu. While no user activity for fifteen seconds (identified by the lack of pressing any button) again causes the shift of the meter in safe condition. The display mode of meter state when the system is not yet secured is signaled by flashing key symbol. When the meter goes to a safe condition, the key is displayed in a continuous way. The device is not implemented any special passwords to unlock. In the case of locked due to forgotten passwords, you can delete a security giving the signal to unlock input 5 and 6 at the time of attaching the supply voltage.

ATTENTION!

External signal does not permanently remove the security of meter. After re-attached the power PIN is enabled

WARRANTY

1. The duration of the warranty is 24 months from the date of purchase.
2. The warranty is valid with the receipt only.
3. Complaints must be filed at the point of purchase or directly with the producer (tel. no. 42-2270971, e-mail: dztech@fif.com.pl).
4. Within the warranty period, the producer undertakes to repair or replace the relay within 14 days from the date the unit is delivered to the service point.
5. The purchaser has the right to have the relay replaced or to receive a refund if an indelible defect is revealed.
6. This warranty does not cover the following:
 - mechanical or chemical defects,
 - defects which stem from improper use contrary to the user's manual,
 - defects which appear after the unit has been sold due to accidents or other events for which neither the producer nor the point of sale can be held responsible, e.g. transport damage, etc.
7. This warranty does not cover any operations which, according to the manual, should be done by the user, e.g. mounting of the relay, installation of the electrical system, installation of other required electrical protection devices, recommended inspections and tests, etc.

ATTENTION!

No unauthorised modifications are to be made in the relay otherwise the device may be damaged or malfunction which in turn may lead to damage of the protected engine and jeopardise its operators. Should this warning be ignored, the producer cannot be held responsible for any related events and is entitled to deem this warranty invalid in the case of any complaint.

ASSEMBLY

- 1) Turn the power distribution box in which the device is attached.
- 2) Mount the device on the rail.
- 3) Connect power cable to joints 1 or 2.
- 4) Connect the other cables, according to the scheme. Please note that when working with DC signals it is important to maintain proper polarity.
- 5) Turn On the power of switchbox and of the meter.

TECHNICAL DATA

Supply	24±264v AC/DC
INPUT voltage	10±264v AC/DC
RESET voltage	24±264v AC/DC
Current load of joint 1P	8A
Power consumption	1,5W
Connections	screw terminals 2,5mm
Working temperature	-20+50°C
Dimensions	3 modules (52,5mm)
Fixing	on the rail TH-35

WIRING DIAGRAM

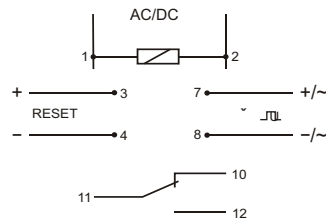

X-ON Electronics

Largest Supplier of Electrical and Electronic Components

Click to view similar products for [Frequency Counters](#) category:

Click to view products by [F&F](#) manufacturer:

Other Similar products are found below :

[MFG-2120MA](#) [3.060.200.383](#) [HK47.C.10-80VDC](#) [3.130.251.071.056](#) [3.220.401.085](#) [3.223.401.351](#) [3.240.201.075](#) [3.241.201.075](#)
[3.242.201.075](#) [3.245.201.351](#) [TFG-3610E](#) [TG5012A](#) [AX-DG105](#) [AX-DG2010AF](#) [3.100.200.383](#) [HMF2525](#) [3.130.251.075.056](#)
[3.130.251.351.056](#) [BZ1224](#) [BZ220A](#) [3.220.401.351](#) [3.240.201.351](#) [3.241.201.351](#) [3.242.201.351](#) [3.245.201.075](#) [3.474.901.075](#)
[3.474.901.084](#) [3.474.911.373](#) [DDS-3X25](#) [0.170.000.075](#) [0.135.200.373](#) [TFG-3620E](#) [0.170.000.351](#) [TGF4162](#) [TGF4242](#) [GFG-3015 + RS232](#)
[HK30.G.48.230VAC/50HZ](#) [HK30.G.48.24VAC/50HZ](#) [0.135.200.302](#) [1803D](#) [53220A/903](#) [1856D](#) [GFG-8215A](#) [GFG-8250A](#) [BG4017-1248](#)
[BW4018-23050](#) [BW4018-2450](#) [BW7089-23050](#) [190.004](#) [190.003](#)