

## GENERAL DESCRIPTION

### AVX SA Series

#### Conformally Coated Axial Leaded MLC

**Temperature Coefficients:** C0G (NP0), X7R, X5R, Z5U  
10, 50, 100, 200 Volts

**Case Material:** Epoxy (Flame Retardant to UL Bulletin  
492, Par. 280)

**Lead Material:** Solderable

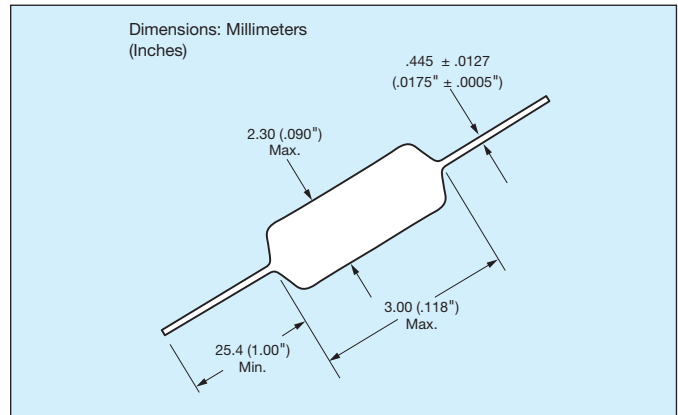

## HOW TO ORDER

<b>SA10</b>	<b>5</b>	<b>E</b>	<b>104</b>	<b>Z</b>	<b>A</b>	<b>R</b>
<b>Conformal Axial Size</b>	<b>Voltage</b>	<b>Dielectric</b>	<b>Capacitance</b>	<b>Capacitance Tolerance</b>	<b>Failure Rate</b>	<b>Leads</b>
SA05 SA10 SA11 SA20 SA30 SA40	Z = 10V 5 = 50V 1 = 100V 2 = 200V	A = C0G (NP0) C = X7R D = X5R E = Z5U	First two digits are the significant figures of capacitance. Third digit indicates the additional number of zeros. For example, order 100,000 pF as 104. (For values below 10pF use "R" in place of decimal point, e.g., 1R4 = 1.4pF)	C0G (NP0): C = ±.25pF D = ±.5pF F = ±1% G = ±2% J = ±5% K = ±10%	X7R: J = ±5% K = ±10% M = ±20%  X5R: K = ±10% M = ±20%  Z5U: M = ±20% Z = +80% -20%	A = Not Applicable  Standard (Solderable) R = RoHS Compliant A = Standard Solderable

## MARKING (EXAMPLE)

SpinGuard marking includes full date code/lot code identification. A first in the industry, this format provides complete traceability to all manufacturing processes involving the basic chip and final assembly. Total Shipment traceability is also provided.

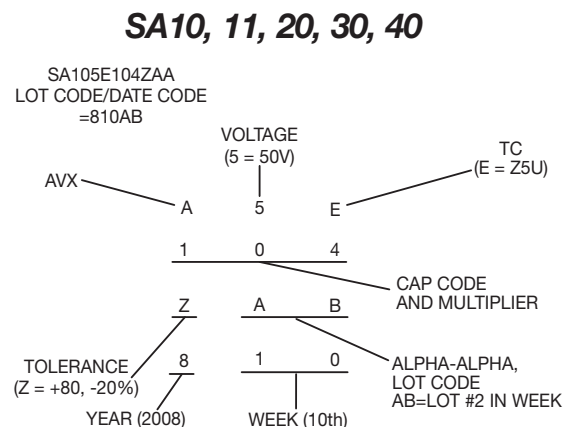
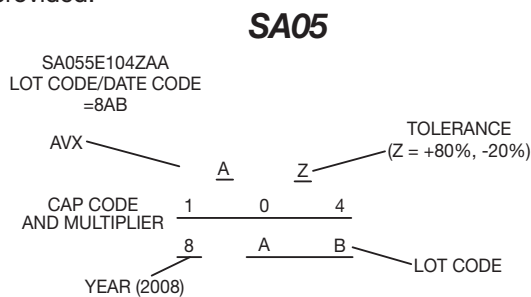

## PACKAGING REQUIREMENTS

- A = Standard Reels (see Page 48)
- B = 1000 piece reels (distributors only, tight tolerance only)
- C = Ammo Pack (see Page 48)
- D thru J = See Special Lead Configurations (Page 41)
- M = 26mm tape and reel
- N = 26mm ammo pack
- R = RoHS, Standard reels (See page 48)

# Axial Leads/SpinGuard®



## C0G (NP0) Dielectric

### SIZE AND CAPACITANCE SPECIFICATIONS

Dimensions: Millimeters (Inches)

AVX Style	SA05	SA10	SA11	SA20	SA30	SA40						
<b>Length (L)</b>	3.00 (.118")	4.32 (.170")	4.32 (.170")	6.60 (.260")	7.37 (.290")	10.16 (.400")						
<b>Diameter (D)</b>	2.30 (.090")	2.54 (.100")	3.05 (.120")	2.54 (.100")	3.81 (.150")	3.81 (.150")						
<b>Lead Diameter</b>	.445 (.0175")	.445 (.0175")	.445 (.0175")	.445 (.0175")	.445 (.0175")	.445 (.0175")						
<b>Lead Length</b>	25.4 (1.00")	25.4 (1.00")	25.4 (1.00")	25.4 (1.00")	25.4 (1.00")	25.4 (1.00")						
Cap. in pF	Typical AVX Part Nos.	WVDC		WVDC			WVDC		WVDC		WVDC	
		200	100	200	100	50	100	50	100	50	100	50
1.0* ↓ 9.1*	SA102A1R0DAR ↓ SA102A9R1DAR											
10 12 15	SA102A100JAR SA102A120JAR SA102A150JAR											
18 22 27	SA102A180JAR SA102A220JAR SA102A270JAR											
33 39 47	SA102A330JAR SA102A390JAR SA102A470JAR											
56 68 82	SA102A560JAR SA102A680JAR SA102A820JAR											
<b>100</b> 120 150	<b>SA102A101JAR</b> SA102A121JAR SA101A151JAR											
180 220 270	SA101A181JAR SA101A221JAR SA101A271JAR											
330 390 470	SA101A331JAR SA101A391JAR SA101A471JAR											
560 680 820	SA101A561JAR SA101A681JAR SA101A821JAR											
<b>1000</b> 1200 1500	<b>SA105A102JAR</b> SA201A122JAR SA201A152JAR											
1800 <b>2200</b> 2700	SA205A182JAR <b>SA301A222JAR</b> SA301A272JAR											
3300 3900 <b>4700</b>	SA301A332JAR SA301A392JAR <b>SA305A472JAR</b>											
5600 6800 8200	SA401A562JAR SA401A682JAR SA405A822JAR											
<b>10,000</b> 12,000	<b>SA405A103JAR</b> SA405A123JAR											

For other tolerances see Part No. Codes  
 For other voltages see Part No. Codes  
 AVX Style

= Industry preferred values

\*\*"C&D" Tolerance Only



# Axial Leads/SpinGuard®



## X7R Dielectric

### SIZE AND CAPACITANCE SPECIFICATIONS

Dimensions: Millimeters (Inches)

AVX Style	SA05	SA10	SA11	SA20	SA30	SA40									
<b>Length (L)</b>	3.00 (.118")	4.32 (.170")	4.32 (.170")	6.60 (.260")	7.37 (.290")	10.16 (.400")									
<b>Diameter (D)</b>	2.30 (.090")	2.54 (.100")	3.05 (.120")	2.54 (.100")	3.81 (.150")	3.81 (.150")									
<b>Lead Diameter</b>	.445 (.0175")	.445 (.0175")	.445 (.0175")	.445 (.0175")	.445 (.0175")	.445 (.0175")									
<b>Lead Length</b>	25.4 (1.00")	25.4 (1.00")	25.4 (1.00")	25.4 (1.00")	25.4 (1.00")	25.4 (1.00")									
Cap. in pF	Typical AVX Part Nos.	WVDC			WVDC		WVDC		WVDC		WVDC		WVDC		
		200	100	50	200	100	50	100	50	100	50	100	50	100	50
220	SA102C221KAR														
270	SA102C271KAR														
330	SA102C331KAR														
390	SA102C391KAR														
470	SA102C471KAR														
560	SA101C561KAR														
680	SA101C681KAR														
820	SA101C821KAR														
1000	SA101C102KAR														
1200	SA101C122KAR														
1500	SA101C152KAR														
1800	SA101C182KAR														
2200	SA101C222KAR														
2700	SA101C272KAR														
3300	SA101C332KAR														
3900	SA101C392KAR														
4700	SA101C472KAR														
5600	SA101C562KAR														
6800	SA101C682KAR														
8200	SA105C822KAR														
<b>10,000</b>	<b>SA105C103KAR</b>														
12,000	SA105C123KAR														
15,000	SA105C153KAR														
18,000	SA105C183KAR														
22,000	SA105C223KAR														
27,000	SA105C273KAR														
33,000	SA105C333KAR														
39,000	SA105C393KAR														
<b>47,000</b>	<b>SA105C473KAR</b>														
56,000	SA115C563KAR														
68,000	SA115C683KAR														
82,000	SA115C823KAR														
<b>100,000</b>	<b>SA115C104KAR</b>														
120,000	SA305C124KAR														
150,000	SA305C154KAR														
180,000	SA305C184KAR														
<b>220,000</b>	<b>SA305C224KAR</b>														
270,000	SA305C274KAR														
330,000	SA305C334KAR														
470,000	SA405C474KAR														

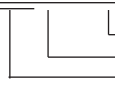
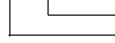
 For other tolerances see Part No. Codes  
 For other voltages see Part No. Codes  
 AVX Style

 = Industry preferred values

# Axial Leads/SpinGuard®



## Z5U Dielectric

### SIZE AND CAPACITANCE SPECIFICATIONS

Dimensions: Millimeters (Inches)

AVX Style	SA05	SA10	SA11	SA20	SA30	SA40
<b>Length (L)</b>	3.00 (.118")	4.32 (.170")	4.32 (.170")	6.60 (.260")	7.37 (.290")	10.16 (.400")
<b>Diameter (D)</b>	2.30 (.090")	2.54 (.100")	3.05 (.120")	2.54 (.100")	3.81 (.150")	3.81 (.150")
<b>Lead Diameter</b>	.445 (.0175")	.445 (.0175")	.445 (.0175")	.445 (.0175")	.445 (.0175")	.445 (.0175")
<b>Lead Length</b>	25.4 (1.00")	25.4 (1.00")	25.4 (1.00")	25.4 (1.00")	25.4 (1.00")	25.4 (1.00")
<b>Cap. in pF</b>	<b>Typical AVX Part Nos.</b>	<b>WVDC 50</b>	<b>WVDC 100 50</b>	<b>WVDC 100 50</b>	<b>WVDC 100 50</b>	<b>WVDC 100 50</b>
10,000 15,000 22,000	SA105E103ZAR SA105E153ZAR SA105E223ZAR					
33,000 47,000 68,000	SA105E333ZAR SA105E473ZAR SA105E683ZAR					
*100,000 150,000 220,000	SA105E104ZAR SA105E154ZAR SA105E224ZAR					
330,000 470,000 680,000	SA115E334ZAR SA305E474ZAR SA305E684ZAR					
820,000 1,000,000	SA305E824ZAR SA305E105ZAR					

For other tolerances see Part No. Codes  
 For other voltages see Part No. Codes  
 AVX Style

= Industry preferred values

\*Preferred Industry Decoupling Capacitor — Insertable on .300" centers.

SA105E104ZAA

# Axial Leads/SpinGuard®



## X5R Dielectric

### SIZE AND CAPACITANCE SPECIFICATIONS

Dimensions: Millimeters (Inches)



AVX Style		SA10
Length (L)		4.32 (.170")
Diameter (D)		2.54 (.100")
Lead Diameter		.445 (.0175")
Lead Length		25.4 (1.00")
Cap. in $\mu$ F	Typical AVX Part Nos.	WVDC 10
1.8	SA10ZD185KAR	
2.7	SA10ZD275KAR	
3.3	SA10ZD335KAR	
4.7	SA10ZD475KAR	

For other tolerances see Part No. Codes  
 For other voltages see Part No. Codes  
 AVX Style

= Industry preferred values

### SPECIAL LEAD CONFIGURATIONS

Dimensions — Body dimensions Per Standard SpinGuard Configurations.  
 Formed dimensions as shown for types D, E, F, G, H, I, & J configurations.

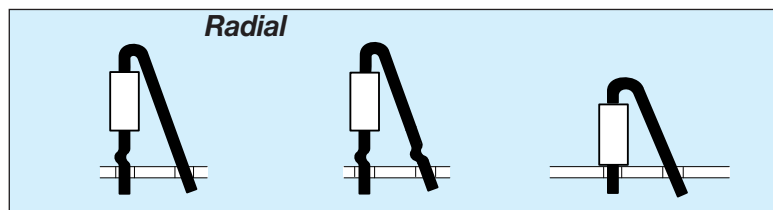

D Single Crimp      E Dual Crimp      F No Crimp

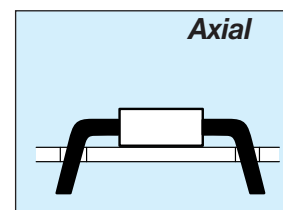

G = .300" L.S.    I = .500" L.S.  
 H = .400" L.S.    J = .600" L.S.

Formed Dimensions:

	LEAD SPACING*	SEATED HEIGHT (Max.)		
	Nom.	D & E	F	G, H, I & J
SA10	.2"	.525"	.300"	.100"
SA20	.2"	.570"	.375"	.100"
SA30	.2"	.580"	.425"	.150"
SA40	.2"	.650"	.460"	.150"

\*Lead spacing can be varied by user to cover .1"-.3" spacing requirements for F, D, and E styles.