

AVX Multilayer Ceramic Transient Voltage Suppressors

GENERAL DESCRIPTION

The AVX TransGuard® Transient Voltage Suppressors (TVS) with unique high-energy multilayer construction represents state-of-the-art overvoltage circuit protection. Monolithic multilayer construction provides protection from voltage transients caused by ESD, lightning, NEMP, inductive switching, etc. True surface mount product is provided in EIA industry standard packages. Thru-hole components are supplied as conformally coated axial devices.

TRANSQUARD® DESCRIPTION

TransGuard® products are zinc oxide (ZnO) based ceramic semiconductor devices with non-linear voltage-current characteristics (bi-directional) similar to back-to-back zener diodes. They have the added advantage of greater current and energy handling capabilities as well as EMI/RFI attenuation. Devices are fabricated by a ceramic sintering process that yields a structure of conductive ZnO grains surrounded by electrically insulating barriers, creating varistor-like behavior.

AVX VG series parts (large case size, high energy) are glass encapsulated. These parts provide the same high reliability as traditional VC series parts. The glass encapsulation provides also enhanced resistance against harsh environment or process such as acids, salts, chlorite flux.

The number of grain-boundary interfaces between conducting electrodes determines "Breakdown Voltage" of the device. High voltage applications such as AC line protection require many grains between electrodes while low voltage requires few grains to establish the appropriate breakdown voltage. Single layer ceramic disc processing proved to be a viable production method for thick cross section devices with many grains, but attempts to address low voltage suppression needs by processing single layer ceramic disc formulations with huge grain sites has had limited success.

AVX, the world leader in the manufacture of multilayer ceramic capacitors, now offers the low voltage transient protection marketplace a true multilayer, monolithic surface mount varistor. Technology leadership in processing thin dielectric materials and patented processes for precise ceramic grain growth have yielded superior energy dissipation in the smallest size. Now a varistor has voltage characteristics determined by design and not just cell sorting whatever falls out of the process.

Multilayer ceramic varistors are manufactured by mixing ceramic powder in an organic binder (slurry) and casting it into thin layers of precision thickness. Metal electrodes are deposited onto the green ceramic layers which are then stacked to form a laminated structure. The metal electrodes are arranged so that their terminations alternate from one end of the varistor to the other. The device becomes a monolithic block during the sintering (firing) cycle providing uniform energy dissipation in a small volume.

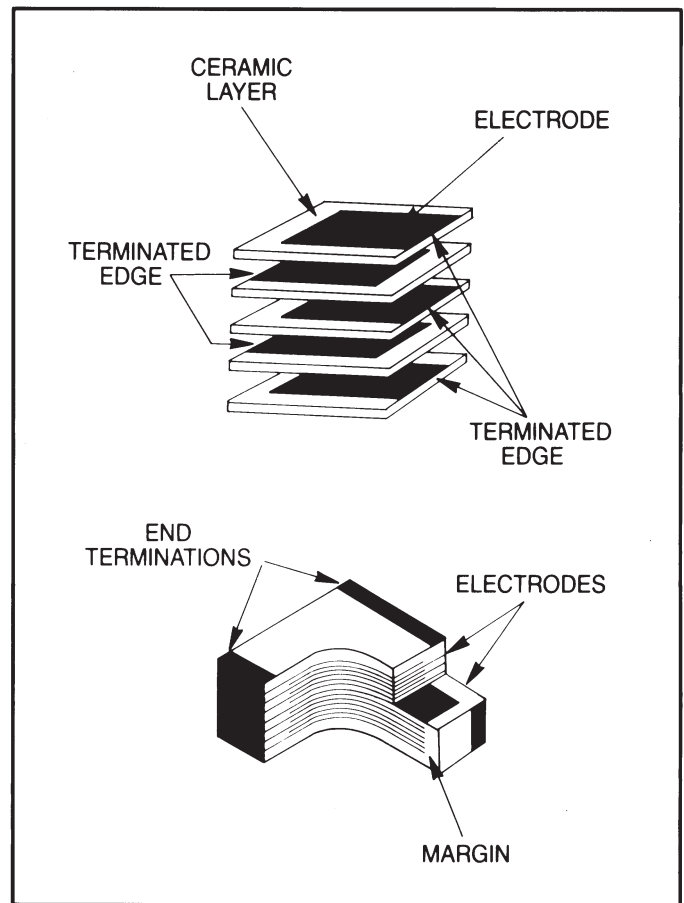
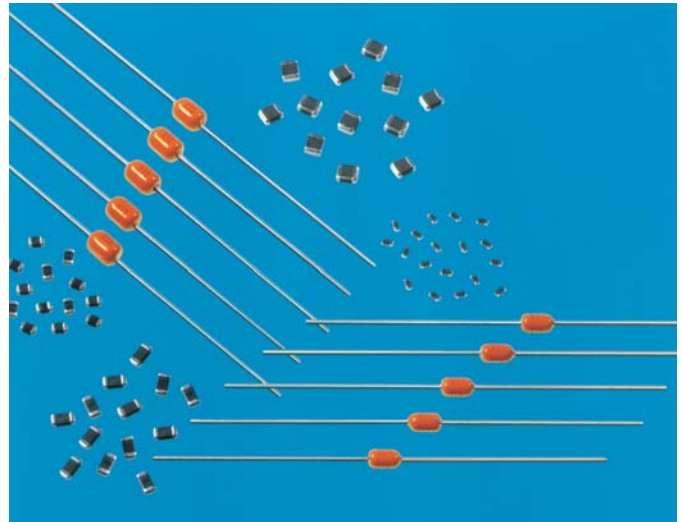

PART NUMBER IDENTIFICATION

Surface Mount Devices

Important: For part number identification only, not for construction of part numbers.

The information below only defines the numerical value of part number digits, and cannot be used to construct a desired set of electrical limits. Please refer to the TransGuard® part number data for the correct electrical ratings.

VC 1206 05 D 150 R P

TERMINATION FINISH:

P = Ni/Sn Alloy (Plated)

PACKAGING (Pcs/Reel):

STYLE	"D"	"R"	"T"	"W"
VC0402	N/A	N/A	N/A	10,000
VC0603	1,000	4,000	10,000	N/A
VC0805	1,000	4,000	10,000	N/A
VC1206	1,000	4,000	10,000	N/A
VC1210	1,000	2,000	10,000	N/A

CLAMPING VOLTAGE:

Where:

100 = 12V	500 = 50V
150 = 18V	560 = 60V
200 = 22V	580 = 60V
250 = 27V	620 = 67V
300 = 32V	650 = 67V
390 = 42V	101 = 100V
400 = 42V	121 = 120V

ENERGY:

Where:

A = 0.1J	J = 1.5J	S = 1.9-2.0J
B = 0.2J	K = 0.6J	T = 0.01J
C = 0.3J	L = 0.8J	U = 4.0-5.0J
D = 0.4J	M = 1.0J	V = 0.02J
E = 0.5J	N = 1.1J	W = 6.0J
F = 0.7J	P = 3.0J	X = 0.05J
G = 0.9J	Q = 1.3J	Y = 12.0J
H = 1.2J	R = 1.7J	Z = 25.0J

WORKING VOLTAGE:

Where:

03 = 3.3 VDC	18 = 18.0 VDC
05 = 5.6 VDC	26 = 26.0 VDC
09 = 9.0 VDC	30 = 30.0 VDC
12 = 12.0 VDC	48 = 48.0 VDC
14 = 14.0 VDC	60 = 60.0 VDC
	85 = 85.0 VDC

CASE SIZE DESIGNATOR:

SIZE	LENGTH	WIDTH
0402	1.00±0.10mm (0.040"±0.004")	0.5±0.10mm (0.020"±0.004")
0603	1.60±0.15mm (0.063"±0.006")	0.8±0.15mm (0.032"±0.006")
0805	2.01±0.2mm (0.079"±0.008")	1.25±0.2mm (0.049"±0.008")
1206	3.20±0.2mm (0.126"±0.008")	1.60±0.2mm (0.063"±0.008")
1210	3.20±0.2mm (0.126"±0.008")	2.49±0.2mm (0.098"±0.008")

CASE STYLE:

C = Chip
G = Chip Glass Encapsulated

PRODUCT DESIGNATOR:

V = Varistor

MARKING:

All standard surface mount TransGuard® chips will **not** be marked.

Axial Leaded Devices

Important: For part number identification only, not for construction of part numbers.

The information below only defines the numerical value of part number digits, and cannot be used to construct a desired set of electrical limits. Please refer to the TransGuard® part number data for the correct electrical ratings.

V A 1000 05 D 150 R L

LEAD FINISH:

Copper clad steel, solder coated

PACKAGING (Pcs/Reel):

STYLE	"D"	"R"	"T"
VA1000	1,000	3,000	7,500
VA2000	1,000	2,500	5,000

CLAMPING VOLTAGE:

Where:

100 = 12V	580 = 60V
150 = 18V	650 = 67V
300 = 32V	101 = 100V
400 = 42V	121 = 120V

ENERGY:

Where: A = 0.1J
D = 0.4J
K = 2.0J

WORKING VOLTAGE:

Where:

03 = 3.3 VDC	26 = 26.0 VDC
05 = 5.6 VDC	30 = 30.0 VDC
14 = 14.0 VDC	48 = 48.0 VDC
18 = 18.0 VDC	60 = 60.0 VDC

CASE SIZE DESIGNATOR:

SIZE	LENGTH	DIAMETER
1000	4.32mm (0.170")	2.54mm (0.100")
2000	4.83mm (0.190")	3.56mm (0.140")

CASE STYLE:

A = Axial

PRODUCT DESIGNATOR:

V = Varistor

MARKING:

All axial TransGuards® are marked with vendor identification, product identification, voltage/energy rating code and date code (see example below):

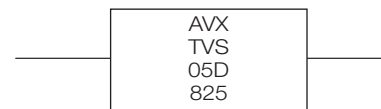

Where: AVX = Always AVX (Vendor Identification)
TVS = Always TVS (Product Identification - Transient Voltage Suppressor)
05D = Working VDC and Energy Rating (Joules)
Where: 05 = 5.6 VDC, D = 0.4J
725 = Three Digit Date Code
Where: 8 = Last digit of year (2008)
25 = Week of year

Not RoHS Compliant



LEAD-FREE
LEAD-FREE COMPATIBLE
COMPONENT



RoHS
COMPLIANT

For RoHS compliant products,
please select correct termination style.

ELECTRICAL CHARACTERISTICS

AVX PN	V _w (DC)	V _w (AC)	V _B	V _C	I _{VC}	I _L	E _T	I _P	Cap	Freq	Case
VC060303A100	3.3	2.3	5.0±20%	12	1	100	0.1	30	1450	K	0603
VC080503A100	3.3	2.3	5.0±20%	12	1	100	0.1	40	1400	K	0805
VC080503C100	3.3	2.3	5.0±20%	12	1	100	0.3	120	5000	K	0805
VC120603A100	3.3	2.3	5.0±20%	12	1	100	0.1	40	1250	K	1206
VC120603D100	3.3	2.3	5.0±20%	12	1	100	0.4	150	4700	K	1206
VA100003A100	3.3	2.3	5.0±20%	12	1	100	0.1	40	1500	K	1000
VA100003D100	3.3	2.3	5.0±20%	12	1	100	0.4	150	4700	K	1000
VC040205X150	5.6	4.0	8.5±20%	18	1	35	0.05	20	175	M	0402
VC060305A150	5.6	4.0	8.5±20%	18	1	35	0.1	30	750	K	0603
VC080505A150	5.6	4.0	8.5±20%	18	1	35	0.1	40	1100	K	0805
VC080505C150	5.6	4.0	8.5±20%	18	1	35	0.3	120	3000	K	0805
VC120605A150	5.6	4.0	8.5±20%	18	1	35	0.1	40	1200	K	1206
VC120605D150	5.6	4.0	8.5±20%	18	1	35	0.4	150	3000	K	1206
VA100005A150	5.6	4.0	8.5±20%	18	1	35	0.1	40	1000	K	1000
VA100005D150	5.6	4.0	8.5±20%	18	1	35	0.4	150	2800	K	1000
VC040209X200	9.0	6.4	12.7±15%	22	1	25	0.05	20	175	M	0402
VC060309A200	9.0	6.4	12.7±15%	22	1	25	0.1	30	550	K	0603
VC080509A200	9.0	6.4	12.7±15%	22	1	25	0.1	40	750	K	0805
VC080512A250	12.0	8.5	16±15%	27	1	25	0.1	40	525	K	0805
VC040214X300	14.0	10.0	18.5±12%	32	1	15	0.05	20	85	K	0402
VC060314A300	14.0	10.0	18.5±12%	32	1	15	0.1	30	350	K	0603
VC080514A300	14.0	10.0	18.5±12%	32	1	15	0.1	40	325	K	0805
VC080514C300	14.0	10.0	18.5±12%	32	1	15	0.3	120	900	K	0805
VC120614A300	14.0	10.0	18.5±12%	32	1	15	0.1	40	600	K	1206
VC120614D300	14.0	10.0	18.5±12%	32	1	15	0.4	150	1050	K	1206
VA100014A300	14.0	10.0	18.5±12%	32	1	15	0.1	40	325	K	1000
VA100014D300	14.0	10.0	18.5±12%	32	1	15	0.4	150	1100	K	1000
VC121016J390	16.0	13.0	25.5±10%	40	2.5	10	1.6	500	3100	K	1210
VG181216P400	16.0	11.0	24.5±10%	42	5	10	2.9	1000	5000	K	1812
VG222016Y400	16.0	11.0	24.5±10%	42	10	10	7.2	1500	13000	K	2220
VC040218X400	18.0	13.0	25.5±10%	42	1	10	0.05	20	65	M	0402
VC060318A400	18.0	13.0	25.5±10%	42	1	10	0.1	30	150	K	0603
VC080518A400	18.0	13.0	25.5±10%	42	1	10	0.1	30	225	K	0805
VC080518C400	18.0	13.0	25.5±10%	42	1	10	0.3	100	550	K	0805
VC120618A400	18.0	13.0	25.5±10%	42	1	10	0.1	30	350	K	1206
VC120618D400	18.0	13.0	25.5±10%	42	1	10	0.4	150	900	K	1206
VC120618E380	18.0	13.0	25.5±10%	38	1	15	0.5	200	930	K	1206
VC121018J390	18.0	13.0	25.5±10%	42	5	10	1.6	500	3100	K	1210
VA100018A400	18.0	13.0	25.5±10%	42	1	10	0.1	40	350	K	1000
VA100018D400	18.0	13.0	25.5±10%	42	1	10	0.4	150	900	K	1000
VG121022R440	22.0	17.0	27±10%	44	2.5	10	1.7	400	1600	K	1210
VC060326A580	26.0	18.0	34.5±10%	60	1	10	0.1	30	155	K	0603
VC080526A580	26.0	18.0	34.5±10%	60	1	10	0.1	30	120	K	0805
VC080526C580	26.0	18.0	34.5±10%	60	1	10	0.3	100	250	K	0805

ELECTRICAL CHARACTERISTICS

AVX PN	V _w (DC)	V _w (AC)	V _B	V _C	I _{vc}	I _L	E _T	I _P	Cap	Freq	Case
VC120626D580	26.0	18.0	34.5±10%	60	1	10	0.4	120	500	K	1206
VC120626F540	26.0	20.0	33.0±10%	54	1	15	0.7	200	600	K	1206
VC121026H560	26.0	18.0	34.5±10%	60	5	10	1.2	300	2150	K	1210
VC181226P540	26.0	20.0	33.0±10%	54	5	15	3.0	800	3000	K	1812
VA100026D580	26.0	18.0	34.5±10%	60	1	10	0.4	120	650	K	1000
VC060330A650	30.0	21.0	41.0±10%	67	1	10	0.1	30	125	K	0603
VC080530A650	30.0	21.0	41.0±10%	67	1	10	0.1	30	90	M	0805
VC080530C650	30.0	21.0	41.0±10%	67	1	10	0.3	80	250	K	0805
VC120630D650	30.0	21.0	41.0±10%	67	1	10	0.4	120	400	K	1206
VC121030G620	30.0	21.0	41.0±10%	67	5	10	0.9	220	1750	K	1210
VC121030H620	30.0	21.0	41.0±10%	67	5	10	1.2	280	1850	K	1210
VC121030S620	30.0	21.0	41.0±10%	67	5	10	1.9	300	1500	K	1210
VA100030D650	30.0	21.0	41.0±10%	67	1	10	0.4	120	550	K	1000
VC080531C650	31.0	25.0	39.0±10%	65	1	10	0.3	80	250	K	0805
VC120631M650	31.0	25.0	39.0±10%	65	1	15	1.0	200	500	K	1206
VC080538C770	38.0	30.0	47.0±10%	77	1	10	0.3	80	200	K	0805
VC120638N770	38.0	30.0	47.0±10%	77	1	15	1.1	200	400	K	1206
VG121038S770	38.0	30.0	47.0±10%	77	2.5	15	2.0	400	1000	K	1210
VG181238U770	38.0	30.0	47.0±10%	77	5	15	4.2	800	1300	K	1812
VG222038Y770	38.0	30.0	47.0±10%	77	10	15	12	2000	4200	K	2220
VC120642L800	42.0	32.0	51.0±10%	80	1	15	0.8	180	600	K	1206
VC120645K900	45.0	35.0	56.0±10%	90	1	15	0.6	200	260	K	1206
VG181245U900	45.0	35.0	56.0±10%	90	5	15	4.0	500	1200	K	1812
VC120648D101	48.0	34.0	62.0±10%	100	1	10	0.4	100	225	K	1206
VC121048G101	48.0	34.0	62.0±10%	100	5	10	0.9	220	450	K	1210
VC121048H101	48.0	34.0	62.0±10%	100	5	10	1.2	250	500	K	1210
VA100048D101	48.0	34.0	62.0±10%	100	1	10	0.4	100	200	K	1000
VC120656F111	56.0	40.0	68.0±10%	110	1	15	0.7	100	180	K	1206
VC181256U111	56.0	40.0	68.0±10%	110	5	15	4.8	500	800	K	1812
VC121060J121	60.0	42.0	76.0±10%	120	5	10	1.5	250	400	K	1210
VA200060K121	60.0	42.0	76.0±10%	120	1	10	2.0	300	400	K	2000
VC120665L131	65.0	50.0	82.0±10%	135	1	15	0.8	100	250	K	1206
VC120665M131	65.0	50.0	82.0±10%	135	1	15	1.0	150	250	K	1206
VG121065P131	65.0	50.0	82±10%	135	2.5	15	2.7	350	600	K	1210
VC121085S151	85.0	60.0	100±10%	150	1	35	2.0	250	275	K	1210

V _w (DC)	DC Working Voltage (V)		Working Voltage (µA)
V _w (AC)	AC Working Voltage (V)	E _T	Transient Energy Rating (J, 10x1000µS)
V _B	Typical Breakdown Voltage (V @ 1mA _{DC})	I _P	Peak Current Rating (A, 8x20µS)
V _B Tol	V _B Tolerance is ± from Typical Value	Cap	Typical Capacitance (pF) @ frequency specified and 0.5 V _{RMS}
V _C	Clamping Voltage (V @ I _{vc})	Freq	Frequency at which capacitance is measured (K = 1kHz, M = 1MHz)
I _{vc}	Test Current for V _C (A, 8x20µS)		
I _L	Maximum Leakage Current at the		

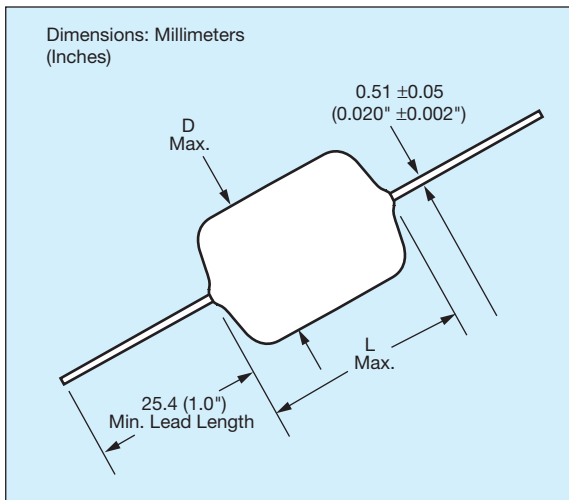

DIMENSIONS: mm (inches)

AVX Style		VA1000	VA2000
(L) Max Length	mm (in.)	4.32 (0.170)	4.83 (0.190)
(D) Max Diameter	mm (in.)	2.54 (0.100)	3.56 (0.140)

Lead Finish: Copper Clad Steel, Solder Coated

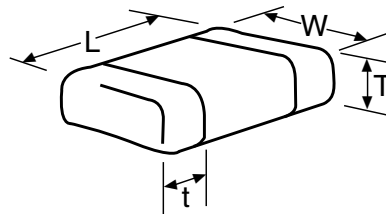

DIMENSIONS: mm (inches)

AVX Style		0402	0603	0805	1206	1210	1812	2220
(L) Length	mm (in.)	1.00±0.10 (0.040±0.004)	1.60±0.15 (0.063±0.006)	2.01±0.20 (0.079±0.008)	3.20±0.20 (0.126±0.008)	3.20±0.20 (0.126±0.008)	4.50±0.30 (0.177±0.012)	5.70±0.40 (0.224±0.016)
(W) Width	mm (in.)	0.50±0.10 (0.020±0.004)	0.80±0.15 (0.031±0.006)	1.25±0.20 (0.049±0.008)	1.60±0.20 (0.063±0.008)	2.49±0.20 (0.098±0.008)	3.20±0.30 (0.126±0.012)	5.00±0.40 (0.197±0.016)
(T) Max Thickness	mm (in.)	0.6 (0.024)	0.9 (0.035)	1.02 (0.040)	1.02 (0.040)	1.70 (0.067)	2.00 (0.080)	2.50 (0.098)
(t) Land Length	mm (in.)	0.25±0.15 (0.010±0.006)	0.35±0.15 (0.014±0.006)	0.71 max. (0.028 max.)	0.94 max. (0.037 max.)	1.14 max. (0.045 max.)	1.00 max. (0.039 max.)	1.00 max. (0.039 max.)

AVX Multilayer Ceramic Transient Voltage Suppressors

TYPICAL PERFORMANCE CURVES (0402 CHIP SIZE)

VOLTAGE/CURRENT CHARACTERISTICS

Multilayer construction and improved grain structure result in excellent transient clamping characteristics up to 20 amps peak current, while maintaining very low leakage currents under DC operating conditions. The VI curves below show the voltage/current characteristics for the 5.6V, 9V, 14V, 18V and low capacitance StaticGuard parts with currents ranging from parts of a micro amp to tens of amps.



PULSE DEGRADATION

Traditionally varistors have suffered degradation of electrical performance with repeated high current pulses resulting in decreased breakdown voltage and increased leakage current. It has been suggested that irregular intergranular boundaries and bulk material result in restricted current paths and other non-Schottky barrier paralleled conduction paths in the ceramic. Repeated pulsing of TransGuard® transient voltage suppressors with 150Amp peak 8 x 20µS waveforms shows negligible degradation in breakdown voltage and minimal increases in leakage current. This does not mean that TransGuard® suppressors do not suffer degradation, but it occurs at much higher current.

ESD TEST OF 0402 PARTS



PEAK POWER VS PULSE DURATION



INSERTION LOSS CHARACTERISTICS

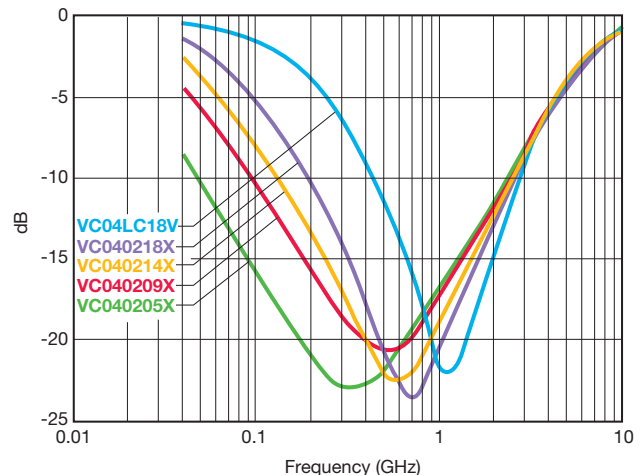

TYPICAL PERFORMANCE CURVES (0603, 0805, 1206 & 1210 CHIP SIZES)

VOLTAGE/CURRENT CHARACTERISTICS

Multilayer construction and improved grain structure result in excellent transient clamping characteristics up to 500 amps peak current, depending on case size and energy rating, while maintaining very low leakage currents under DC operating conditions. The VI curve below shows the voltage/current characteristics for the 3.3V, 5.6V, 12V, 14V, 18V, 26V, 30V, 48V and 60VDC parts with currents ranging from parts of a micro amp to tens of amps.

VI Curves - 3.3V and 5.6V Products



VI Curves - 9V, 12V, and 14V Products

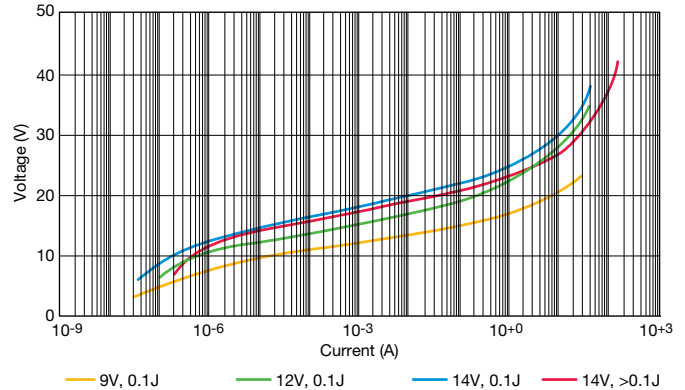

VI Curves - 18V and 26V Products

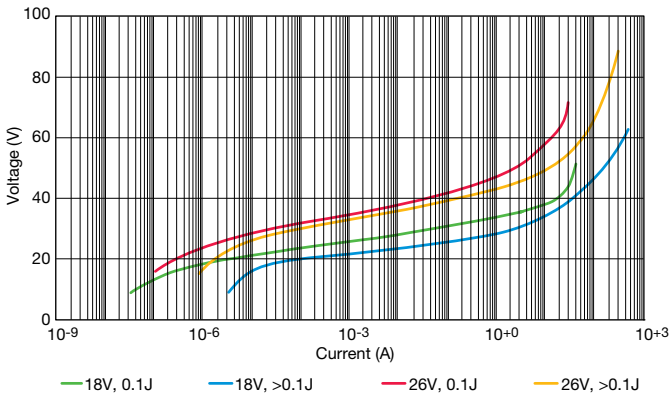

VI Curves - 30V, 48V, and 60V Products



VI Curve - 85V Product



AVX Multilayer Ceramic Transient Voltage Suppressors

TYPICAL PERFORMANCE CURVES (0603, 0805, 1206 & 1210 CHIP SIZES)

TYPICAL PULSE RATING CURVE
3.3V MULTILAYER TRANSGUARD[®]



TYPICAL PULSE RATING CURVE
26V MULTILAYER TRANSGUARD[®]



TYPICAL PULSE RATING CURVE
5.6V MULTILAYER TRANSGUARD[®]



TYPICAL PULSE RATING CURVE
30V MULTILAYER TRANSGUARD[®]



TYPICAL PULSE RATING CURVE
14V MULTILAYER TRANSGUARD[®]



TYPICAL PULSE RATING CURVE
48V MULTILAYER TRANSGUARD[®]



TYPICAL PULSE RATING CURVE
18V MULTILAYER TRANSGUARD[®]

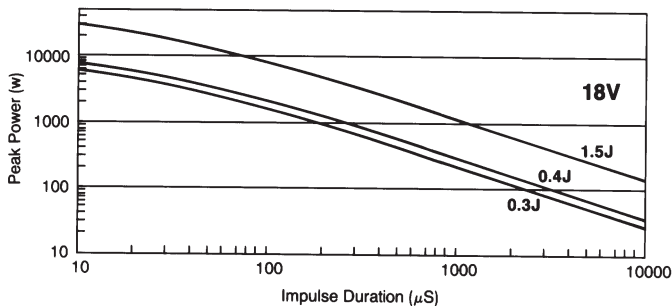

TYPICAL PULSE RATING CURVE
60V MULTILAYER TRANSGUARD[®]

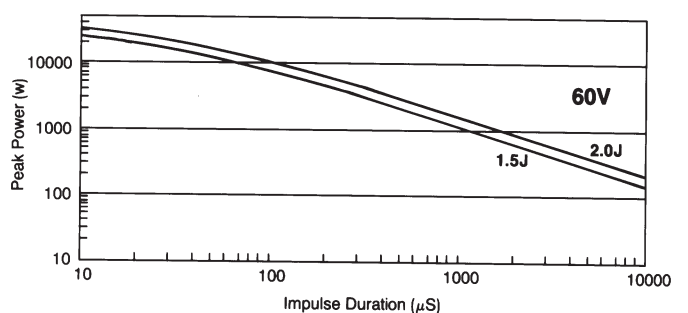

TYPICAL PERFORMANCE CURVES (0603, 0805, 1206 & 1210 CHIP SIZES)

TEMPERATURE CHARACTERISTICS

TransGuard® suppressors are designed to operate over the full temperature range from -55°C to +125°C. This operating temperature range is for both surface mount and axial leaded products.

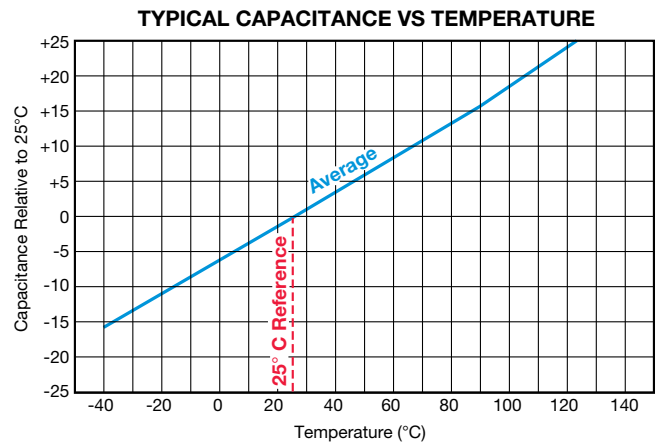
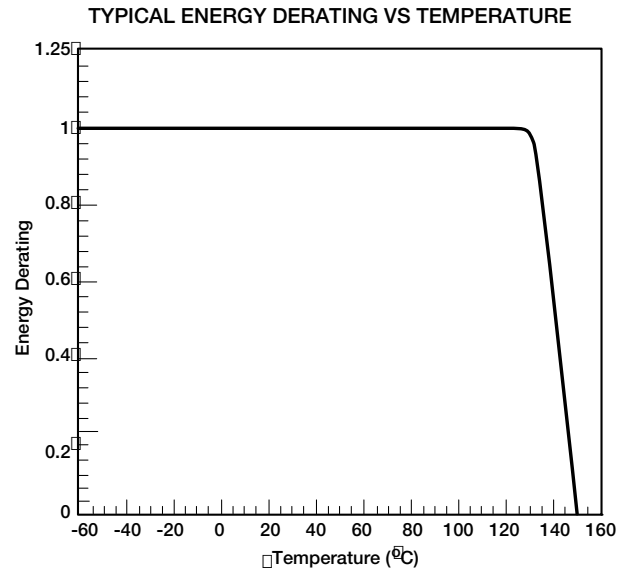

TYPICAL PERFORMANCE CURVES (0603, 0805, 1206 & 1210 CHIP SIZES)

PULSE DEGRADATION

Traditionally varistors have suffered degradation of electrical performance with repeated high current pulses resulting in decreased breakdown voltage and increased leakage current. It has been suggested that irregular intergranular boundaries and bulk material result in restricted current paths and other non-Schottky barrier paralleled conduction paths in the ceramic. Repeated pulsing of both 5.6 and 14V TransGuard® transient voltage suppressors with

150 Amp peak $8 \times 20\mu\text{s}$ waveforms shows negligible degradation in breakdown voltage and minimal increases in leakage current. This does not mean that TransGuard® suppressors do not suffer degradation, but it occurs at much higher current. The plots of typical breakdown voltage vs number of 150A pulses are shown below.



Figure 1



Figure 3



Figure 2



Figure 4

CAPACITANCE/FREQUENCY CHARACTERISTICS

TransGuard® Capacitance vs Frequency 0603

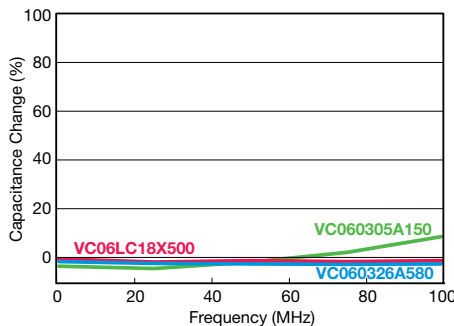

TransGuard® Capacitance vs Frequency 0805



TransGuard® Capacitance vs Frequency 1206

