

micro SD Card Connector

SERIES

5138

micro SD Card Connector

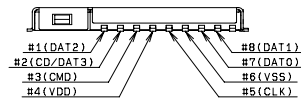
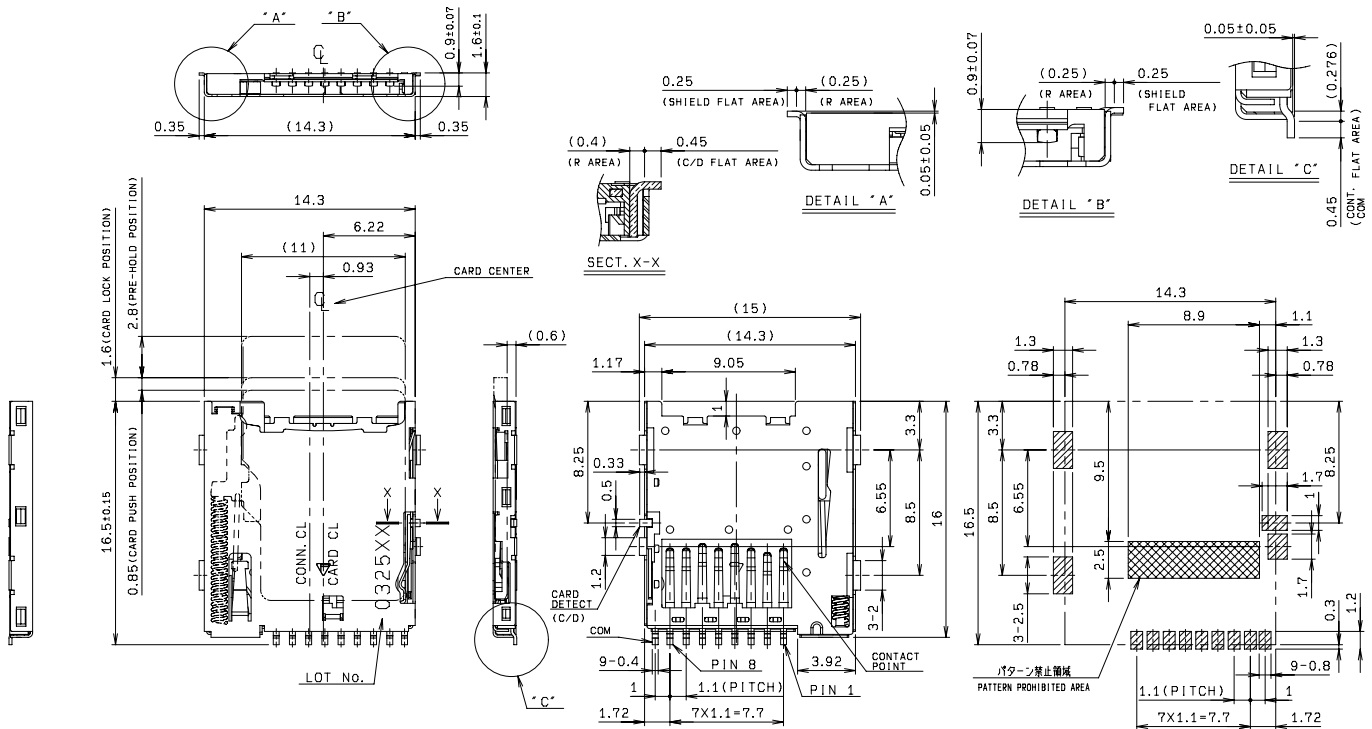

回路構成

CIRCUIT

WITHOUT

CARD

CD GND

CARD

INSERTED

CD GND

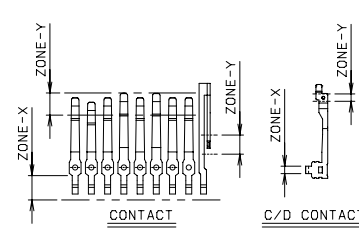

RECOMMENDED PCB PATTERN LAYOUT

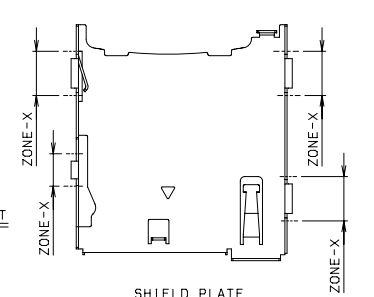

SHIELD PLATE

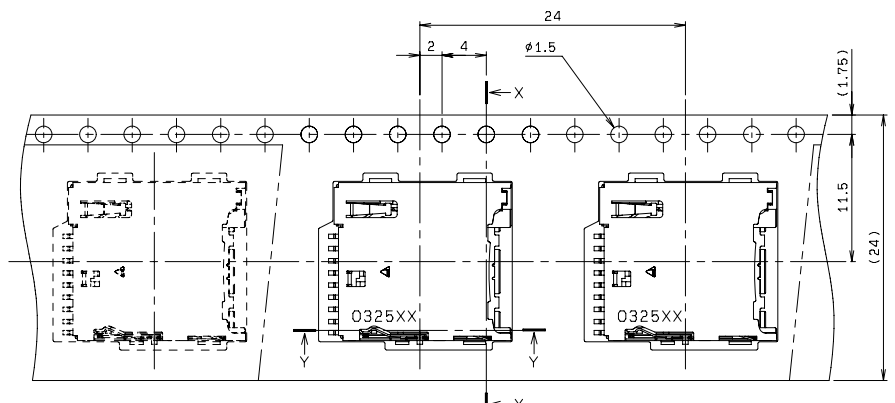

SECT. X-X

SECT. Y-Y

注文コード ORDERING CODE
04 5138 008 100 858 +

RoHS 対応品
RoHS Compliant Product

梱包数量 1000個 / リール
PACKING QUANTITY : 1000/Reel

5138

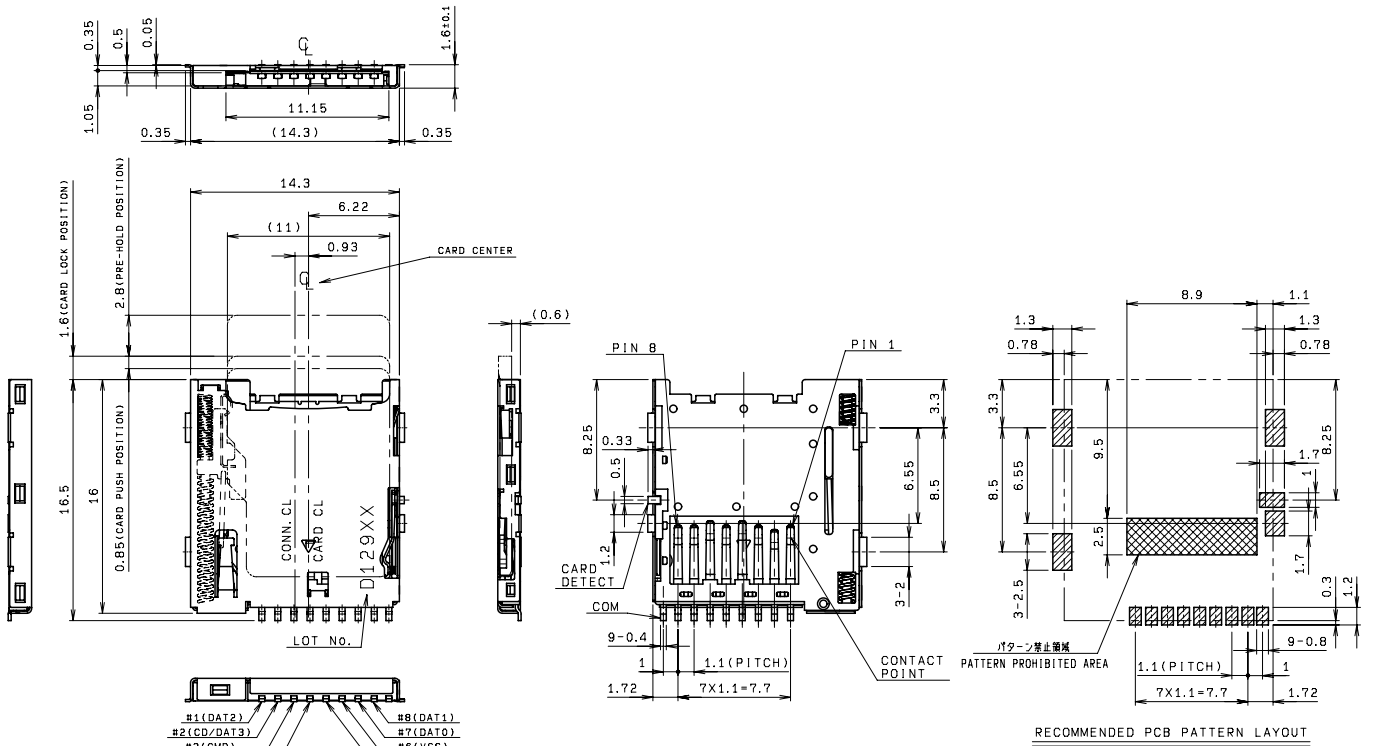

回路構成

CIRCUIT

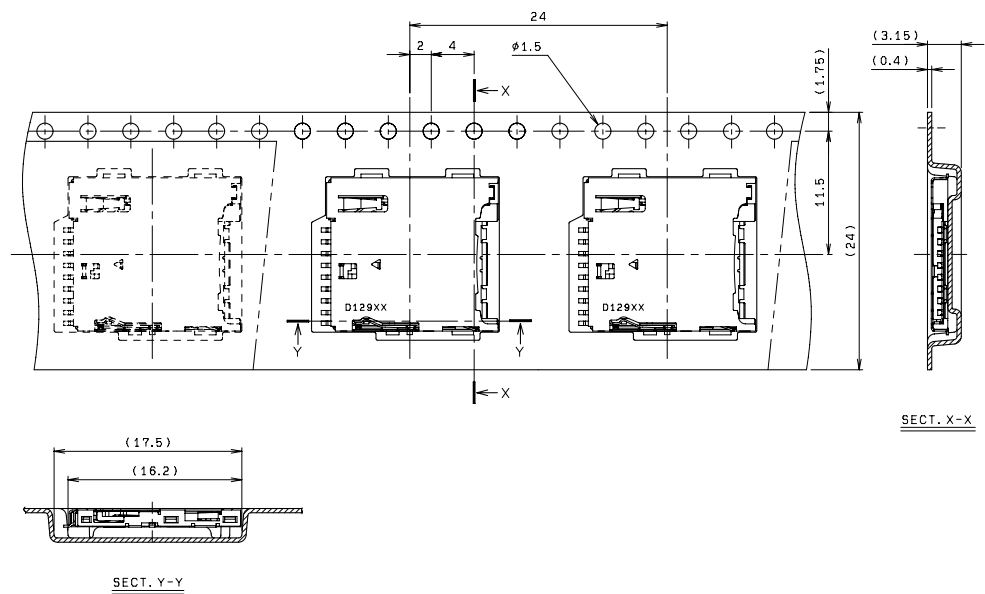
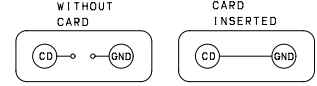

注文コード ORDERING CODE
04 5138 008 010 890 +

RoHS 対応品
RoHS Compliant Product

梱包数量 1000 個 / リール
PACKING QUANTITY : 1000/Reel