

To put the finishing touch on your application, we offer an extensive selection of useful accessories to build and install DIN Rail terminal block assemblies and to facilitate factory and field wiring.

Accessories include end stops, end plates and partitions. Also offered are DIN Rails, ferrules, jumpers and more. From design to commissioning and operation, Altech accessories help you do the job better.

We've tried to make the selection of accessories as easy as possible. The most common accessories are listed together with their ordering information on each terminal block page in this catalog.

# ACCESSORIES

T E R M I N A L   B L O C K S



## MOUNTING

DIN Mounting Rails are internationally standardized and available in 35mm, 32mm and 15mm sizes, with or without perforations. These also accommodate a wide variety of control components such as circuit breakers, timers, motor starters, relays, switches, etc. The 15mm rail with miniature blocks is used when space is at a premium.

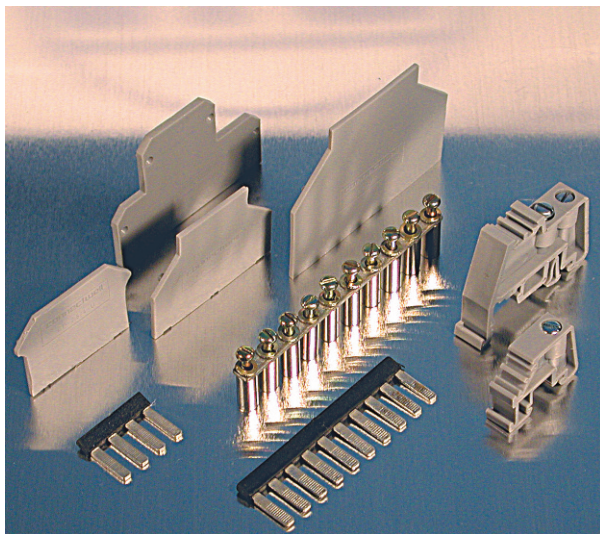
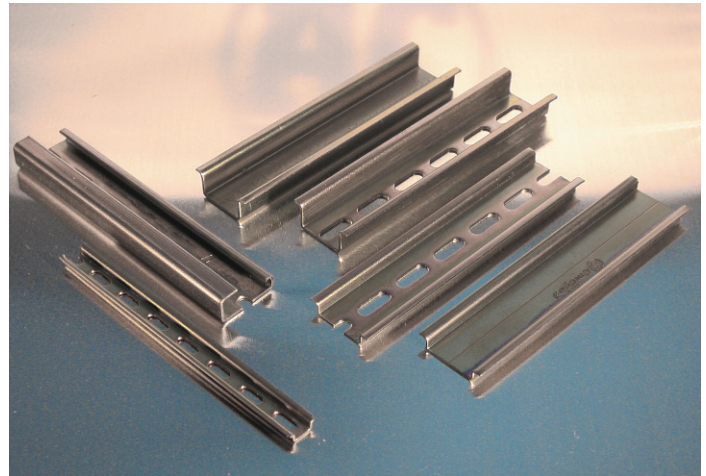

## ACCESORIES

Altech accessories add the finishing touches to your terminal block assemblies. End Stops prevent terminal blocks or other components and devices from moving laterally on the rail.

End Plates close off the last terminal in a series, a vital function, since sectional terminal blocks are supplied with one side open. Isolation partitions provide visual separation of terminal groups, as well as electrical isolation between terminals of different potentials.

## INTERCONNECTION

In addition, Altech offers a wide choice of both Internal and External Jumpers to minimize wiring time and reduce installation cost. Available in standard 2, 3, 4 and 10 pole configurations, or custom multipole jumpers. Our internal jumpers screw directly into terminal block busbars.

External jumpers are available in straight-comb styles. They may be used for terminal blocks without internal jumpering provisions or in combination with internal jumpers.

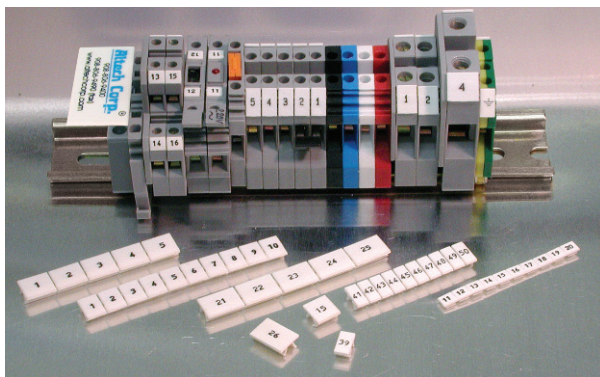
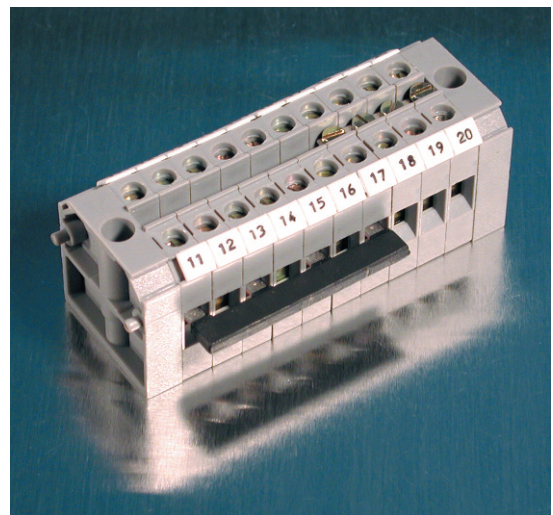

## MARKING TAGS

Marking Tags make DIN Rail assemblies easier to wire and facilitate troubleshooting. Altech's extensive terminal block marking system includes standard or custom printed push on tags in a variety of sizes for circuit identification.



# Altech TERMINAL BLOCK ACCESORIES

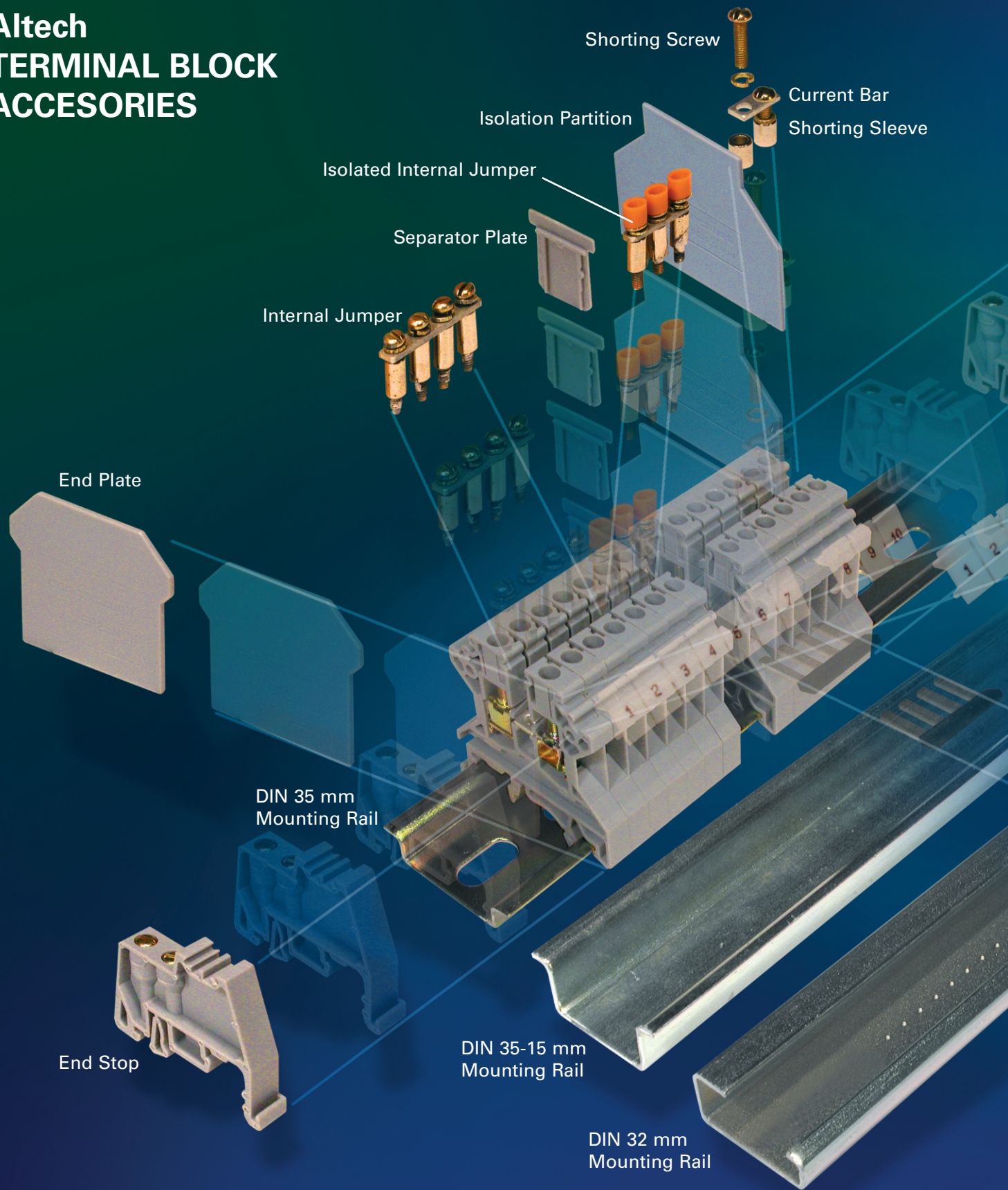



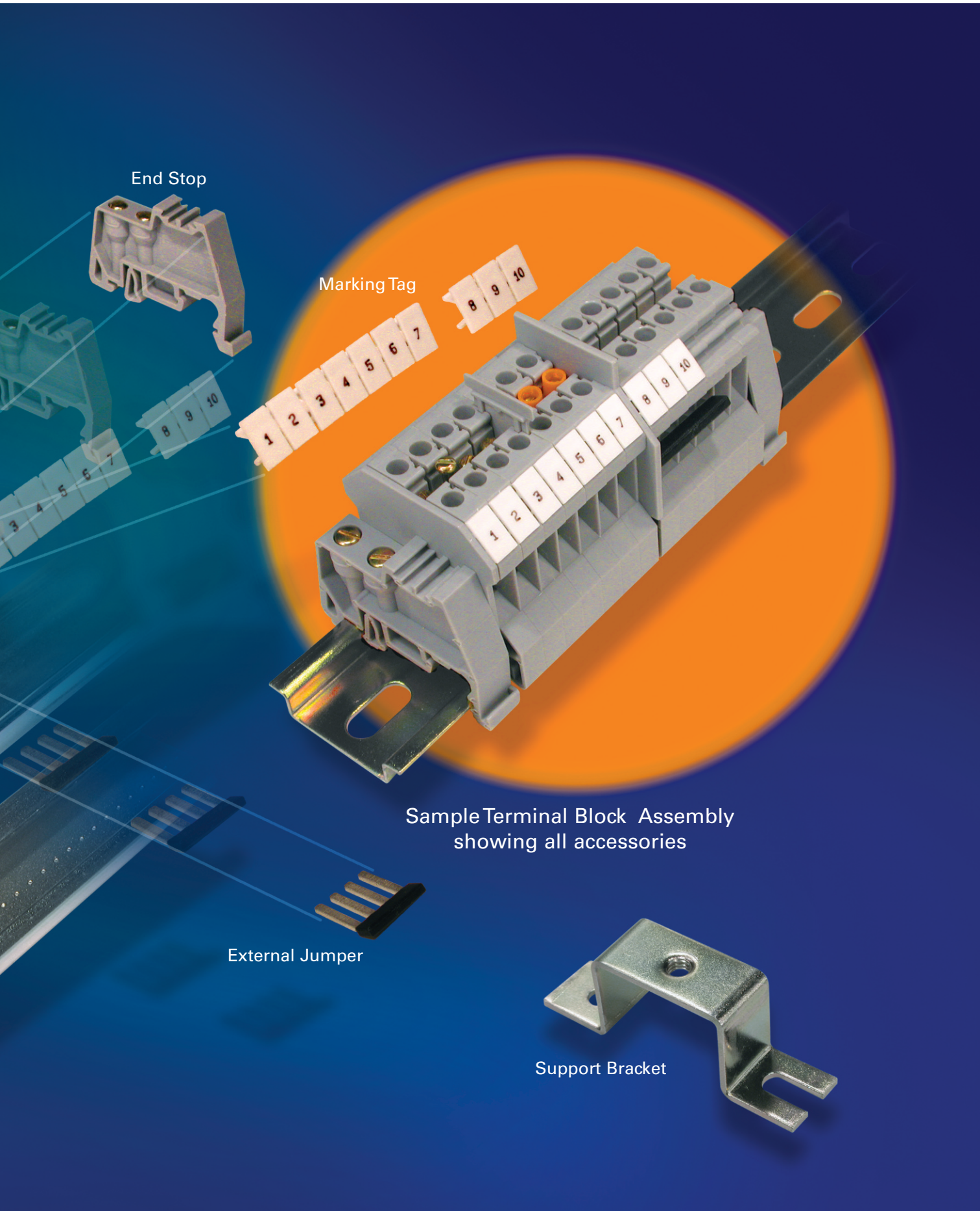

End Stop

Marking Tag

Sample Terminal Block Assembly showing all accessories

External Jumper

Support Bracket



# Terminal Block Accessories

## DIN Mounting Rails

Altech DIN Rails comply with DIN 50045, 50022 and 50035 Standards. DIN Rails have been accepted throughout the world, allowing the designer to mount a wide variety of control components, devices, terminal blocks, etc. on the same rail. The use of DIN Rails enhances design capabilities, saves space and reduces labor.

Standard rails are made of steel with zinc plating and chromate passivation and are available in various configurations.

DIN Rails are available in 35mm (7.5 and 15mm deep), 32mm and 15mm widths and are supplied in 1 m (3'3") and 2 m (6'6") lengths. Upon request they can be cut to custom lengths and punched with holes or perforations.

- 35mm, 32mm, 15mm
- Perforated or unperforated
- Rail material is steel with electrolytic zinc plating

### DIN35

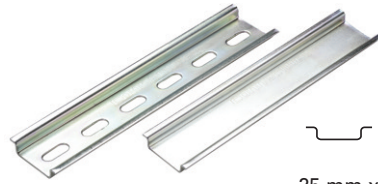

35 mm x  
7.5 mm deep

Type	Cat. No.	Length	Std. Pk.
Perforated Steel	2511120	2m	20
	2511120/1M	1m	40
Unperforated Steel	2511110	2m	20
	2511110/1M	1m	40

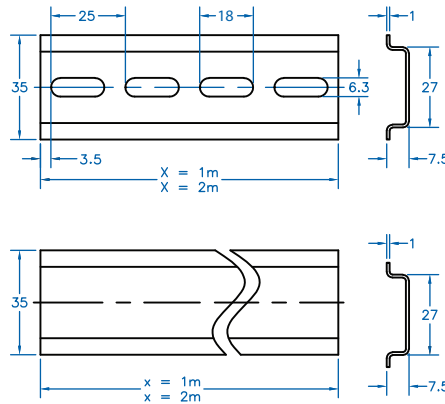

### DIN35

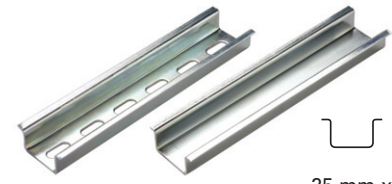

35 mm x  
15 mm deep

Type	Cat. No.	Length	Std. Pk.
Perforated Steel	CA701-15/S-2M	2m	10
	CA701-15/S	1m	20
Unperforated Steel	CA701-15-2M	2m	10
	CA701-15	1m	20

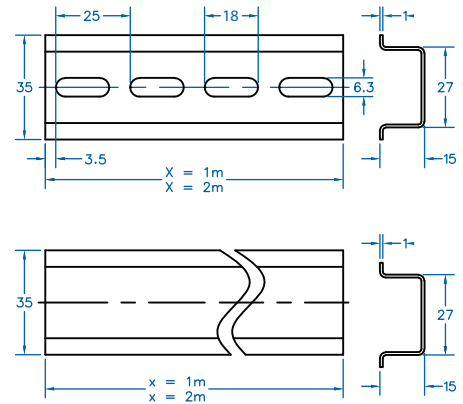

## Support Brackets

Support Brackets elevate DIN Rails away from the panel to facilitate component mounting and to increase wiring access. Angled brackets tilt the rail by 35° to improve visibility. Straight brackets are available in three heights for optimum positioning of the rail.

Brackets mount with 2 screws to any panel or flat surface and have tapped center holes for rail mounting. Bracket material is steel, zinc plated yellow chromated.

### CA603

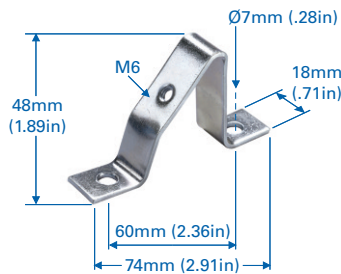

Suitable for all mounting rails

Cat. No.	Std. Pk.
CA603	25

### TSTW

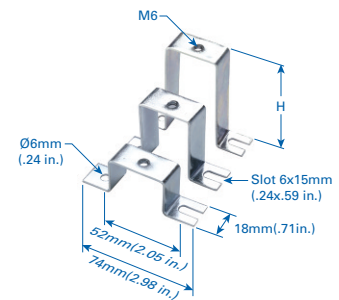

Height	Cat. No.	Std. Pk.
1"	CA703	25
2"	CA803	25
3"	CA903	25



**DIN32**

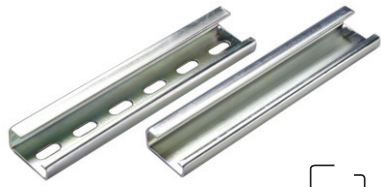

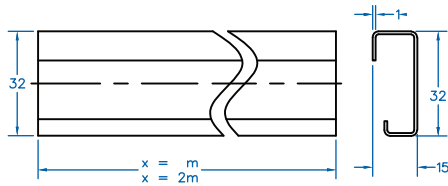
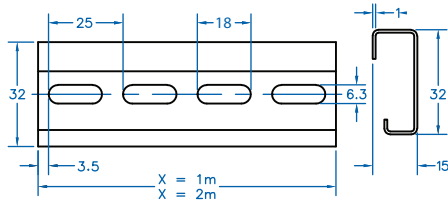

  
32 mm x  
15 mm deep

Type	Cat. No.	Length	Std. Pk.
Perforated Steel	2511160	2m	10
	2511160/1M	1m	20
Unperforated Steel	2511150	2m	10
	2511150/1M	1m	20

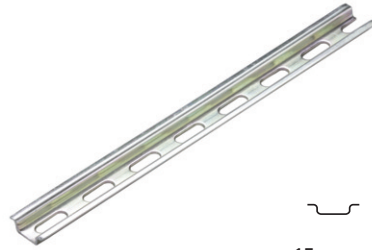

**DIN15**



  
15 mm x  
5.5 mm deep

Type	Cat. No.	Length	Std. Pk.
Perforated Steel	CA601/S	1m	50

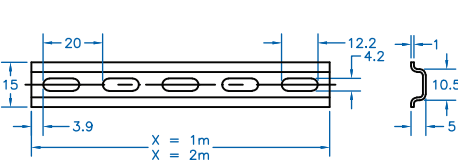

**Mounting Handle**

Mounting handle is used for mounting 10 terminal blocks on a DIN rail, thus saving considerable time. Specially designed pins in the mounting handle grip the terminal blocks when pressed against entry.

See page 8 for appropriate terminal blocks.



**MH2.5**



**MH4**



Cat. No.	Handle for	Std. Pk.
MH2.5	CTS2.5U-N	1

Cat. No.	Handle for	Std. Pk.
MH4	CTS4U-N	1



# Terminal Block Accessories

## End Stops

End Stops prevent terminal blocks and other DIN Rail mount components and devices from moving laterally on the rail. They are available in polyamide 6.6 and metal configurations for 35mm, 32mm, and 15mm DIN rails. CA102 and CA202 are large endstops for heavy duty applications.

The CA103 is screwless and ergonomically snaps into place, saving costs and labor. It utilizes two precisionally mounted metal inserts that grip firmly onto the DIN rail holding any assembly into place.

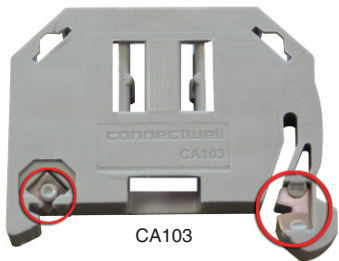

CA102		CA202		CA702		CA802		CA602	
Material: Polyamide 6.6		Material: Polyamide 6.6		Material: Polyamide 6.6		Material: Polyamide 6.6		Material: Polyamide 6.6	
Dimensions H x L x W: 46 x 50 x 9 mm		Dimensions H x L x W: 44.5 x 50 x 9.5 mm		Dimensions H x L x W: 34 x 44 x 9 mm		Dimensions H x L x W: 32 x 45 x 8 mm		Dimensions H x L x W: 20 x 28 x 8 mm	
Cat. No.	Std. Pk.	Cat. No.	Std. Pk.	Cat. No.	Std. Pk.	Cat. No.	Std. Pk.	Cat. No.	Std. Pk.
CA102	50	CA202	25	CA702	50	CA802	50	CA602	50
Suitable for: 32 and 35 mm DIN Rails		Suitable for: 35 mm DIN Rails		Suitable for: 32 and 35 mm DIN Rails		Suitable for: 35 mm DIN Rails		Suitable for: 15 mm DIN Rails	

CA103		CA302		CA402		CA502	
Material: Polyamide		Material: Steel		Material: Steel		Material: Steel	
Dimensions H x L x W: 41 x 35 x 6 mm		Dimensions H x L x W: 27 x 39.5 x 16 mm		Dimensions H x L x W: 27 x 39.5 x 16 mm		Dimensions H x L x W: 25 x 22.5 x 11.5 mm	
Cat. No.	Std. Pk.	Cat. No.	Std. Pk.	Cat. No.	Std. Pk.	Cat. No.	Std. Pk.
CA103	50	CA302	50	CA402	50	CA502	50
Suitable for: 35 mm DIN Rails		Suitable for: 35x7.5mm DIN Rails		Suitable for: 35x15 mm DIN Rails		Suitable for: 32 mm DIN Rails	

## Spacer / Separator

CASP is a DIN Rail mountable spacer generally used for circuit separation.

## DIN Rail Mounting Foot

CMTB-35 is used to assemble components on a DIN rail. Comes with pre-punched holes.

- Support bracket for DIN rail mounting parts
- Hole Qty x dia., 4x4.3mm, 2x5.5mm

CASP		CMTB-35		CDL4U SPACER	
Material: Polyamide 6.6		Material: Polyamide 6.6		Material: Polyamide 6.6	
Dimensions H x L x W: 29 x 43 x 8 mm		Dimensions H x L x W: 18 x 58 x 18 mm		Dimensions H x L x W: 54 x 55.5 x 6 mm	
Cat. No.	Std. Pk.	Cat. No.	Std. Pk.	Cat. No.	Std. Pk.
CASP	50	CMTB-35	50	CDL4USP	50
Suitable for: All DIN Rails		Suitable for: Mounting Foot for 35 mm DIN rails		Suitable for: All DIN Rails	



**Group Identification**

GMH6, GMH7 & GMH8

To be mounted directly on Din Rails (GMH6 & GMH7). A marker card needs to be inserted in the slot which is covered by a transparent plastic sheet. (Blank marker and transparent sheet included).



**Mountable on**  
All mounting rails  
**Dimension**  
**GMH6** 46.5(H) x 44.5(W) x 9.5(T) mm

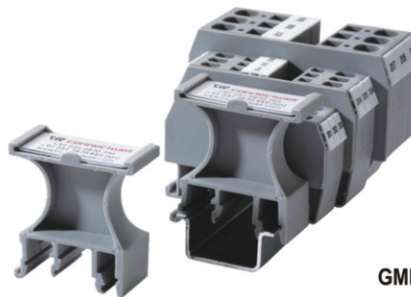

**Mountable on**  
All mounting rails  
**Dimension**  
**GMH7** 46.5(H) x 44.5(W) x 19.5(T) mm

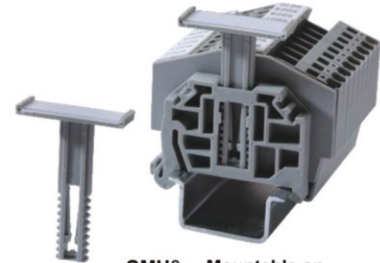

**GMH8 Mountable on**  
CA103  
**Dimension**  
44 (H) x 30.5(W) x 10(T) mm



Group Marker,  
shown imprinted and  
attached to CA 702.  
Blank and custom  
printing available.  
Cat. No. MTG1

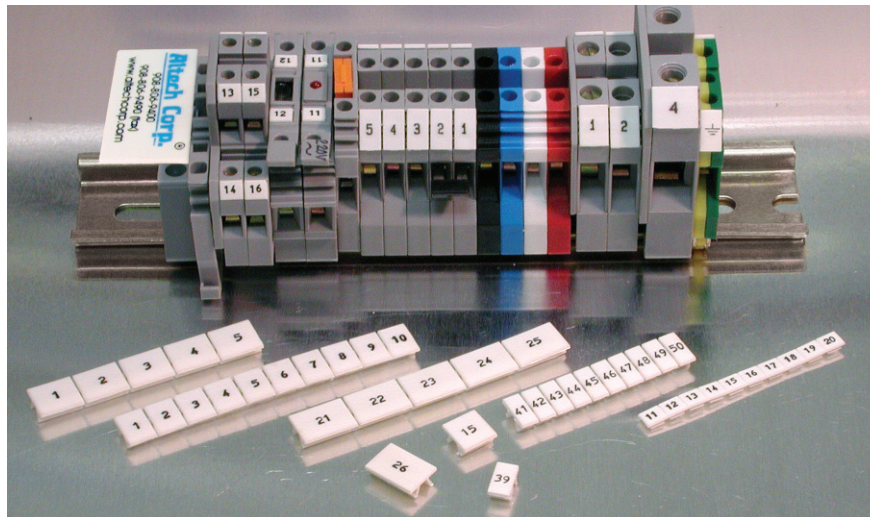



## End Plates

End plates are used to cover the open side of sectional DIN Rail mount terminal blocks. They should be used at the end of an assembly of identical terminal blocks or whenever there is a change in the physical size of the terminal block.

- Material: polyamide 6.6
- Standard color: gray

## END PLATES



Cat. No.	Std. Pk.	Dimensions (H x L x W)	Suitable for:
EP2.5/4UN	50	32 x 39 x 1.5	CTS2.5UN/4UN/CTT2.5UK/T/J/E
EP6/10U	50	31 x 42.5 x 1.5	CTS6U/CTS10U
EP25U	50	40 x 48 x 2	CTS25U
EP35	50	43 x 50 x 1.5	CTS35U
EPCMC1-2	50	35.5 x 46.5 x 2.5	CMC1-2
EPCMC2-2	50	40.5 x 65 x 2.5	CMC2-2
EPCDL4U	50	43 x 55 x 2.4	CDL4U/CDL4U(I.S)/ CDL4U(E) Series
EPODL4U	50	49 x 68 x 5.5	ODL4U/ODL4UA(Front Side)
EP1ODL4U	50	24 x 68 x 3	ODL4U/ODL4UA(Back Side)
EPCTL2.5U	50	55.5 x 84 x 1.5	CTL2.5U/2.5UL/2.5U(I.S)
EPCTL2.5UH	50	55.5 x 61 x 1.5	CTL2.5UH/2.5UH(L)/2.5UH(I.S)D2
EPCMT4	50	22.5 x 27 x 1.5	CMT4/CMT4S/CMT4SU
EPCMB4	50	27 x 27 x 7	CMB4
EPCSFL4U	50	28 x 55.5 x 1.6	CSFL4U/4U(L)/CSDL4U
EPCSFL6U	50	42.5 x 36 x 1.5	CSFL6U/CSDL6U
EPCAFL4U	25	32 x 72 x 1.5	CAFL4U/4UL/4UN
EPDDL4U	25	49 x 87.6 x 3	DDFL4U/4ULR/4U(E)/4U(E)LR
EPCDTTU	50	41 x 63 x 3	CDTTU/CDTTUSH
EPCKT4U	50	30.5 x 46.5 x 2.5	CKT4U
EPCGT4U	50	40.5 x 43 x 1	CGT4U
EPCTC4U	50	34.5 x 47 x 2.5	CTC4U
EPCSTSN5U	50	31 x 50 x 1.5	CSTSN4U/N5U/N6U/B4U/B5U
EPSTH4	50	39.5 x 46 x 1.5	STH4
EPSTH4DT	50	37.5 x 86 x 1.5	STH4DT / STH4DTSH
EPCSC2.5T	50	23 x 58 x 1.5	CSC2.5T/CSCG2.5T
EPCSC4T	50	28 x 65 x 1.5	CSC4T/CSCG4T
EPCSC6T	50	32 x 72 x 2	CSC6T/CSCG6T
EPCSC10T	50	37.5 x 75 x 1.5	CSC10T/CSCG10T
EPCSC16T	50	82 x 38 x 1.5	CSC16T/CSCG16T
EPCSCP2.5T(L&R)	25	27.5 x 35 x 5	CSCP2.5T/CSCP2.5T2
EPCSC2.5T1-2	50	27 x 74 x 1.5	CSC2.5T1-2
EPCSC2.5T2-2	50	25 x 90 x 1.5	CSC2.5T2-2/CSC2.5T/4(E)D3
EPCSC4T1-2	50	28.5 x 84.5 x 1.5	CSC4T1-2
EPCSC4T2-2	50	28.5 x 105 x 1.5	CSC4T2-2
EPCSC6T1-2	50	94 x 30 x 1.5	CSC6T1-2
EPAS2.5	50	35 x 54 x 1.5	AS2.5, 2.5/3, 2.5/4, AGT2.5, 2.5/3, 2.5/4
EPAS4	50	27.5 x 61 x 1.5	AS4, 4/3, 4/4, AGT4, 4/3, 4/4
EPAS6	50	33.5 x 74 x 1.5	AS6, 6/3, AGT6, 6/3
EPASF4	50	37 x 86 x 1.5	ASF4/ASF4L
EPADL2.5	50	43.5 x 80 x 1.5	ADL2.5/ADL2.5(E)D1/D2
EPADLG2.5	50	83.8 x 58 x 1.2	ADLG2.5
EPADL2.5	50	100 x 69.7 x 1.2	ATL2.5
EPATL2.5H	50	77.3 x 69.7 x 1.2	ATL2.5H
EPATLG2.5	50	100 x 68.8 x 1.2	ATLG2.5
EPCDL4UN	50	47.5 x 57 x 1.5	CDL4UN/CDL4UN(I.S)
EPCDLG2.5	50	48 x 71.4 x 1.2	CDLG2.5
EPCTLG2.5	50	62.5 x 87.5 x 1.2	CTLG2.5
EPCKT4U/4	50	65 x 38.3 x 1.5	CKT4U/4
EPCDS6U	50	37.2 x 82 x 1.5	CDS6U/6UTS/6UFT/6USC
EPUSC	50	52 x 48.5 x 1.5	CHV4U/6U/10U

**Isolation Partitions**

Isolation partitions provide separation between terminal blocks with different potentials. When used for DC power applications, voltages of up to ± 600V DC can be used on either side of the isolation partition. They also provide visual separation between groups of blocks.

- Material: polyamide 6.6
- Standard color: gray

**PARTITIONS**



Cat. No.	Std. Pk.	Dimensions (H x L x W)	Suitable for:
PP2.5/4UN	50	37 x 44 x 1.6	CTS2.5UN/4UN/CTT2.5UK/T/J/E
PP6/10U	50	37.5 x 56.5 x 1.5	CTS6U/CTS10U
PP25U	50	46.5 x 62 x 1.5	CTS25U
PP25UN	50	42.5 x 62 x 1	CTS25UN
PP35U	50	50 x 64.5 x 1.5	CTS35U
PP35UN	50	50 x 64.5 x 1	CTS35UN
PPCMT4	50	32.5 x 37 x 1.6	CMT4/CMT4S/CMT4SU
PPCSFL4U	50	42.5 x 62 x 1.5	CSFL4U/4U(L)/CSDL4U
PPCSC2.5T	50	28 x 58.7 x 1.5	CSC2.5T/CSCG2.5T
PPCSC4T	50	33 x 65 x 1.5	CSC4T/CSCG4T
PPCSC6T	50	36.5 x 72 x 2	CSC6T/CSCG6T

**Separator Plates**

Used for electrical separation of adjacent jumpers. They can be inserted after the terminal blocks have been assembled on DIN rail. There is no loss of width.

**SEPARATOR PLATES**



Cat. No.	Std. Pk.	Dimensions (H x L x W)	Suitable for:
SP2.5/4UN	100	17.5 x 17.4 x 1.4	CTS2.5UN/4UN/CTT2.5UK/T/J/E
SP6/10U	100	15.4 x 16.2 x 1.5	CTS6U/CTS10U/16U
SPCDL4U	100	15.4 x 16.2 x 1.6	CDL4U/CDL4U(I.S)/ CDL4U(E) Series
SPCMB4	100	14.5 x 12 x 1.5	CMB4
SPCDLG2.5	100	11 x 10.5 x 1	CDLG2.5

**Protective Cover / Side Holding Plates**

For protection against dust and shock, transparent protective cover can be installed above the terminal block assembly with the aid of side/holding plates. The side holding plates can be fitted on 35 mm and 32 mm Din rails. These plates should be backed by standard end stops.

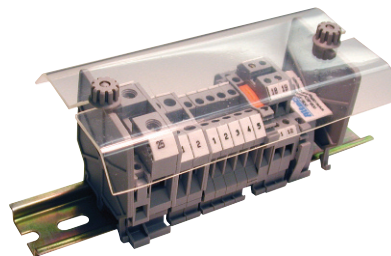

*Assembled Block installed with Protective Cover*

**CTSPC**

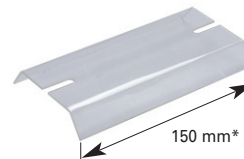

*For all Rail Mounting Terminals  
\*Other lengths available on request.*

**CSP1**



*Mounting Accessories for CTSPC*



# Screw Clamp Terminal Block Accessories

## Jumpering System

The jumpering systems bus potentials between terminal blocks, reducing wiring time. Adjacent blocks or selective terminal blocks within an assembly can be easily interconnected, leaving terminal clamps free for wiring. Purchase complete assemblies, which are ready for installation, or select individual components to create custom or extra long jumpers. Jumper ampacity is lower than the rated current of the respective terminal blocks, therefore, applied current must not exceed the maximum current value of the block. Internal jumpers may be used in combination with external jumpers to achieve additional jumpering possibilities.

## Internal Jumper Assemblies

Internal Jumper Assemblies consist of a Current Bar, Shorting Sleeves and screws. They install easily into the center of the terminal block and connect to the current bar. They are available as standard 2, 3, 4 or 10 pole assemblies and are ready for immediate installation. Insulated internal jumpers provide shock protection when installed on terminal block assemblies.

## External Jumper

External Jumpers bus potentials between terminal blocks, reducing wiring time. Adjacent or selected blocks within an assembly can be easily interconnected. Jumper poles may be removed for selective jumpering. Jumpers are insulated and available in 2, 3, 4 and 10 pole versions. They are made of tin plated brass/copper.

## Current Bars

Current Bars are offered to create custom jumper assemblies for increased number of poles or custom jumpers. Select the current bar with the required number of poles, or field cut them to the required length. They are made of tin or nickel plated copper or brass.

## Shorting Sleeves & Screws

Shorting Sleeves & Screws ensure reliable and mechanically safe electrical connections between current bars and the terminal block current bars. One shorting sleeve is required for each jumpered terminal. They are made of nickel plated brass.

<sup>1</sup> Internal Jumpering System not available.

<sup>2</sup> 100 pole strip can be broken down to any number of poles desired.

### INTERNAL JUMPER



### INSULATED INTERNAL JUMPER



Terminal Series	Poles	Cat. No.	Torque	Std. Pk.	Cat. No.	Torque	Std. Pk.
CTS2.5UN	2	CA721/2	0.4 Nm	100	CA741/2	0.4 Nm	100
	3	CA721/3		100	CA741/3		100
	4	CA721/4		100	CA741/4		100
	10	CA721/10		10	CA741/10		10
	100 <sup>2</sup>	CA721/100		10	CA741/100		10
CTS4UN CMC1-2 CMC2-2 CTS4UTM CKT4U CDL4UN	2	CA722/2	0.4 Nm	100	CA742/2	0.4 Nm	100
	3	CA722/3		100	CA742/3		100
	4	CA722/4		100	CA742/4		100
	10	CA722/10		10	CA742/10		10
	100 <sup>2</sup>	CA722/100		10	CA742/100		10
CTS6U CDTTU <sup>1</sup> CDTTU-SH <sup>1</sup> CSDL6U <sup>1</sup> CSFL6U <sup>1</sup>	2	CA723/2	0.5 Nm	100	CA743/2	0.5 Nm	100
	3	CA723/3		50	CA743/3		50
	4	CA723/4		50	CA743/4		50
	100	CA723/10		10	CA743/10		10
CTS10U	2	CA724/2	0.5 Nm	100	CA744/2	0.5 Nm	100
	3	CA724/3		50	CA744/3		50
	4	CA724/4		50	CA744/4		50
	10	CA724/10		10	CA744/10		10
CTS16U	2	CA751/2	0.8 Nm	50	CA761/2	0.8 Nm	50
	3	CA751/3		50	CA761/3		50
	4	CA751/4		50	CA761/4		50
	10	CA751/10		10	CA761/10		10
CTS25U	2	CA725/2	0.8 Nm	50	CA745/2	0.8 Nm	50
	3	CA725/3		20	CA745/3		20
	4	CA725/4		20	CA745/4		20
	10	CA725/10		10	CA745/10		10
CTS35U	2	CA726/2	0.8 Nm	50	CA746/2	0.8 Nm	50
	3	CA726/3		20	CA746/3		20
	4	CA726/4		20	CA746/4		20
	10	CA726/10		10	CA746/10		10
CTS35UN*	2	CA771/2	0.8 NM	50	CA781/2	0.8 NM	50
	3	CA771/3		20	CA781/3		20
	4	CA771/4		20	CA781/4		20
	10	CA771/10		10	CA781/10		10
CMT4 CMT4S CMB4 CDL4U CDL4U(I.S) ODL4U CDL4UTM	2	CA727/2	0.4 Nm	100	CA747/2	0.4 Nm	100
	3	CA727/3		100	CA747/3		100
	4	CA727/4		100	CA747/4		100
	10	CA727/10		10	CA747/10		10
	100 <sup>2</sup>						
DDFL4U DDFL4U(E) DDD4U CSFL4U <sup>1</sup> CSFL4U(L) <sup>1</sup> CSDL4U	2	CA729/2	0.5 Nm	100	CA749/2	0.5 Nm	100
	3	CA729/3		50	CA749/3		50
	4	CA729/4		50	CA749/4		50
	10	CA729/10		10	CA749/10		10
CAFL4U CAFL4U(L) <sup>1</sup>	2						
	3						
	4						
	10						
CTL2.5U CTL2.5UH CTL2.5UL CTL2.5UHL CTL2.5U(I.S)	2	CA722/2	0.4 Nm	100			
	3	CA722/3		50			
	4	CA722/4		50			
	10	CA722/10		20			
	100 <sup>2</sup>	CA722/100		20			
	10 (breakable)						

**EXTERNAL JUMPER**



**CURRENT BAR**



**SHORTING SLEEVE & SCREWS**



Cat. No.	Torque	Std. Pk.
CA717/2	0.4 Nm	100
CA717/3		100
CA717/4		100
CA717/10		20
CA714/2	0.5 Nm	100
CA714/3		100
CA714/4		100
CA714/10		20
CA710/2	0.8 Nm	100
CA710/3		50
CA710/4		50
CA710/10		20
CA718/2	0.8 Nm	100
CA718/3		50
CA718/4		50
CA718/10		20
CA714/2	0.5 Nm	100
CA714/3		100
CA714/4		100
CA714/10		20
CA711/2	0.8 Nm	100
CA711/3		50
CA711/4		50
CA711/10		20
CA716/2	0.8 Nm	50
CA716/3		50
CA716/4		50
CA716/10		20
CA715/2	0.4 Nm	100
CA715/3		100
CA715/4		100
CA715/10		20

Cat. No.	Std. Pk.
CA703/01	100
CA704/01	100
CA705/01	100
CA731/10	100
CA731/100	10
CA703/1	100
CA704/1	100
CA705/1	100
CA732/10	10
CA732/100	100
CA703/2	100
CA704/2	100
CA705/2	100
CA733/10	100
CA703/3	100
CA704/3	100
CA705/3	100
CA734/10	100
CA703/8	100
CA704/8	100
CA705/8	100
CA739/10	100
CA703/4	100
CA704/4	100
CA705/4	100
CA735/10	100
CA703/5	100
CA704/5	100
CA705/5	100
CA736/10	100
CA703/10	100
CA704/10	100
CA705/10	100
CA770/10	100
CA703/1	100
CA704/1	100
CA705/1	100
CA732/10	100
CA732/100	10
CA732/10-A	100
CA703/6	100
CA704/6	100
CA705/6	100
CA737/10	100
CA703/1	100
CA704/1	100
CA705/1	100
CA732/10	100
CA732/100	10
CA732/10-A	100

Cat. No.	Torque	Std. Pk.
CA707/S/Q/01	0.4 Nm	100
CA707/S/Q/01	0.4 Nm	100
CA707/S/Q/1	0.5 Nm	100
CA707/S/Q/1	0.5 Nm	100
CA707/S/Q/1	0.5 Nm	100
CA707/S/Q/5	0.8 Nm	100
CA707/S/Q/2	0.8 Nm	100
CA707/S/Q/2	0.8 Nm	100
CA707/S/Q/2	0.8 Nm	100
CA707/S/Q	0.4 Nm	100
CA707/S/Q/3	0.5 Nm	100
CA707/S/Q/01	0.4 Nm	100



# Screw Clamp Terminal Block Accessories

## ALTERNATE JUMPER



## WIRE TYPE JUMPER



## ADJACENT JUMPER

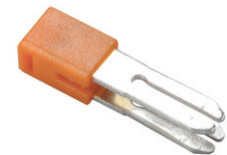

Terminal	Cat. No.	Std. Pk.	Cat. No.	Std. Pk.	Cat. No.	Std. Pk.
CSC2.5T	CA801/1-3	100	CA901/1	100	CA801/1	100
CSC4T	CA801/2-3	100	CA901/2	100	CA801/2	100
CSC6T	CA801/3-3	100	CA901/3	100	CA801/3	100
CSC10T					CA801/4	100
CSC2.5T1-2	CA801/1-3	100	CA901/1	100	CA801/1	100
CSC2.5T2-2	CA801/1-3	100	CA901/1	100	CA801/1	100
CSC4T1-2	CA801/2-3	100	CA901/2	100	CA801/2	100
CSC4T2-2	CA801/2-3	100	CA901/2	100	CA801/2	100
CSC6T1-2	CA801/3-3	100	CA901/3	100	CA801/3	100
CSCP2.5T					CA803/1	100
CSCP2.5T2					CA803/1	100
ADL2.5	CA801/1-3	100	CA901/1	100	CA801/1	100
ASF4					CA801/7	100

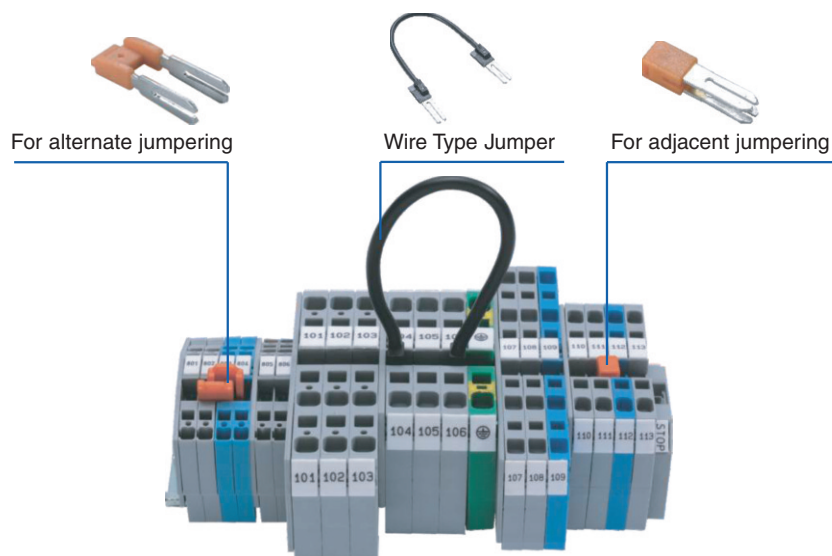

## Step Down Jumpers

Used for jumpering different size blocks.

Terminal	Cat. No.	Std. Pk.
CSC6T – CSC4T	CA901/4	100
CSC6T – CSC2.5T	CA901/5	100
CSC4T – CSC2.5T	CA901/6	100



# Altech MOTOR DISCONNECT SWITCHES

## FEATURES AND BENEFITS:

- One of the smallest 60A switches in the industry
- Advanced switch technology (use of silver contacts ensures safe and durable operation)
- Across the line, motor starting - up to 75hp/600V
- General Use Rating - 16A to 150A/600V
- Available as rotary switches for extended or direct handle applications
- Toggle switches
- Non-fused switch
- Short Circuit Withstand Rating of 10kA with back-up fuse
- DIN Rail and panel mount available
- Comprehensive range of accessories
- Snap on auxiliary contacts
- Enclosed switches with NEMA Type 4X rating
- Operating temperature is -20°C to +40°C

## UL60947-4-1A (Formerly UL508) Listed Manual Motor Controllers

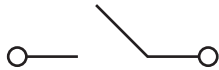

with Disconnecting Means



E185115

AC Motor Across-The-Line  
AC General Use



**EXTENDED / DIRECT HANDLE  
MOTOR DISCONNECT SWITCH**



**EXTENDED / DIRECT HANDLE  
ACCESSORIES**



**TOGGLE HANDLE  
MOTOR DISCONNECT SWITCH**



**POLYCARBONATE ENCLOSED  
MOTOR DISCONNECT SWITCHES &  
FUSED ENCLOSED  
MOTOR DISCONNECT SWITCH (30A)**



**ALUMINUM ENCLOSED  
MOTOR DISCONNECT SWITCHES**



**SHEET METAL ENCLOSED  
MOTOR DISCONNECT SWITCHES**



**STAINLESS STEEL ENCLOSED  
MOTOR DISCONNECT SWITCHES**



# Fuses

Cylinder Fuses are typically used in industrial applications to protect electrical devices such as motors, drives, etc.

They are available in four sizes with a current range from 1 to 125 Amps. Cylinder Fuses have metal caps at both ends, and a porcelain fuse body.

## OPERATING CLASSES

### gL/gG - Line Protection

Slow, typically used for distribution circuits or resistive loads.

Typical Markings: gL/gG

### aM - Motor Protection

Fast acting short circuit protection, but slow acting overload protection.

Typical Marking: aM

### aR - Semiconductor Protection

Partial range, short circuit protection for devices such as diodes, SCRs, etc.

Typical Markings: Ultra Rapid™, Sitor™, Silcu™, Protister™, Recticur™, Ultra Quick™, aR 

### Note:

Other fuse sizes and fuse holders are available. Please refer to the Altech European Fuse catalog for more information.

### gL/gG - Line Protection

Standard: IEC 20269-4-1 and IEC60269-1  
Rated Voltage: 500V



10x38

Rated Current/ Rated Voltate	Cat. No.	Std. Pk.
0.5A	2620017	10
1A	2620000	10
2A	2620001	10
4A	2620003	10
6A	2620005	10
8A	2620006	10
10A	2620007	10
12A	2620008	10
16A	2620009	10
20A	2620011	10
25A	2620013	10
32A*	2620015	10

\*400V

### aM - Motor Protection

Standard: IEC 20269-4-1 and IEC60269-1  
Rated Voltage: 500V



10x38

Rated Current/ Rated Voltate	Cat. No.	Std. Pk.
0.5A	2621017	10
1A	2621000	10
2A	2621001	10
4A	2621003	10
6A	2621005	10
8A	2621006	10
10A	2621007	10
12A	2621008	10
16A	2621009	10
20A	2621011	10
25A	2621013	10
32A*	2621015	10

\*400V

### aR - Semiconductor Protection

Standard: IEC 60269-4-1  
Breaking Capacity: ~200 kA  
Rated Voltage: ~600V\*\*



10x38

In (A)	Cat. No.	Operating I <sup>2</sup> -value (A's)	Power Dissipation (W)	Std. Pk.
6	2625005	30	1.5	10
8	2625006	50	2	10
10	2625007	70	2.5	10
12	2625008	120	3	10
16	2625009	150	3.5	10
20	2625011	260	4.8	10
25	2625013	290	6	10
32	2625015	600	7.5	10

\*\* 6-25A (700V DC/ breaking capacity ≡ 50kA)  
32A (400V DC/ breaking capacity ≡ 50kA)

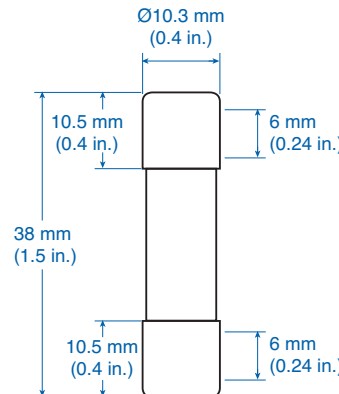

Miniature Fuses are typically used to protect electronic devices, laboratory instruments, stereos, TV's, VCR's etc. They are available in four sizes with a current range of 20mA to 20 Amps. Miniature Fuses are manufactured according to VDE 0820 part 1, VDE 0820 part 2, IEC publication 127, CEE publication 4 and actual DIN standards.

The 5x20, 5x25 fuses can be used in the CSFL4U series terminal blocks. The 6.3x32 fuse can be used in the CAFL4U series terminal blocks.

Operating Class:  
**Slow**, Typical Marking: "T"  
**Medium**, Typical Marking: "M"  
**Fast**, Typical Marking: "F"

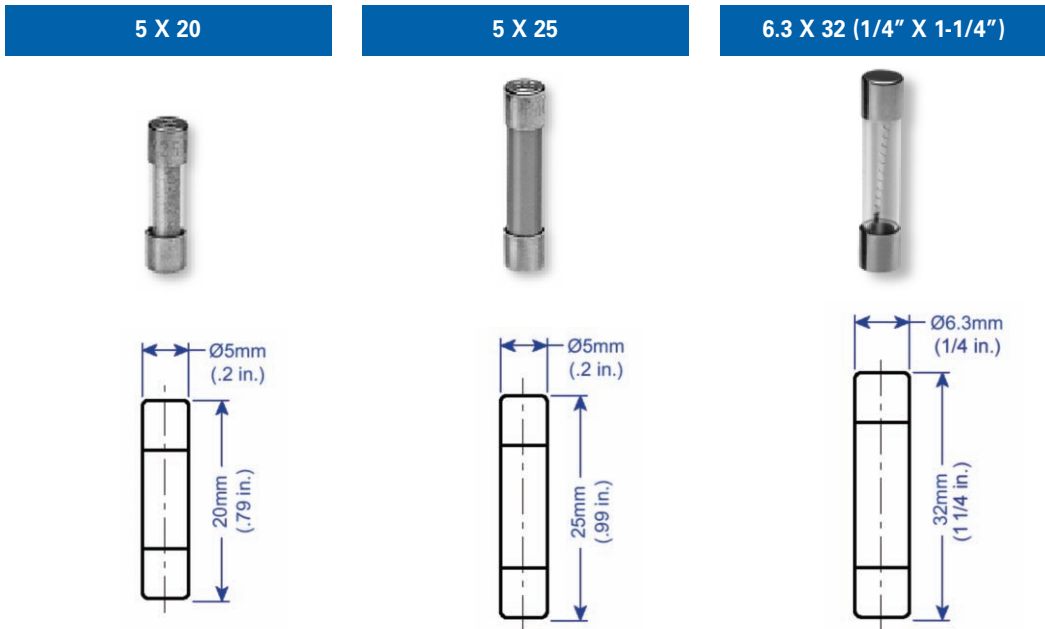

Current	Voltage 250V AC/DC DIN 41662 IEC-127-2/III			DIN 41571-2	DIN 41661 IEC-127-2/II	Voltage 250V AC/DC DIN 41571-2		Voltage 250V AC/DC	
	Cat. No.			Fast	Fast	Cat. No.		Cat. No.	
	Slow	Medium	Fast			Medium	Slow	Fast	
20mA		0.02M5x20M				0.032M5x25M		0.032M6.3x32T	
32mA		0.032M5x20M				0.04M5x25M		0.04M6.3x32T	
40mA						0.05M5x25M		0.05M6.3x32T <sup>4</sup>	0.05M6.3x32F
50mA	0.05M5x20T <sup>4</sup>	0.05M5x20M	0.05M5x20F <sup>4</sup>			0.063M5x25M		0.063M6.3x32T <sup>4</sup>	0.063M6.3x32F
63mA		0.063M5x20M				0.08M5x25M		0.08M6.3x32T <sup>4</sup>	0.08M6.3x32F
80mA	0.08M5x20T <sup>4</sup>	0.08M5x20M				0.1M5x25M		0.1M6.3x32T <sup>4</sup>	0.1M6.3x32F
100mA	0.1M5x20T <sup>4</sup>	0.1M5x20M	0.1M5x20F <sup>4</sup>			0.125M5x25M		0.125M6.3x32T <sup>4</sup>	0.125M6.3x32F
125mA	0.125M5x20T <sup>4</sup>	0.125M5x20M	0.125M5x20F <sup>4</sup>			0.16M5x25M		0.16M6.3x32T <sup>4</sup>	0.16M6.3x32F
160mA	0.16M5x20T <sup>4</sup>	0.16M5x20M	0.16M5x20F <sup>4</sup>			0.2M5x25M		0.2M6.3x32T <sup>4</sup>	0.2M6.3x32F
200mA	0.2M5x20T <sup>4</sup>	0.2M5x20M	0.2M5x20F <sup>4</sup>			0.25M5x25M		0.25M6.3x32T <sup>4</sup>	0.25M6.3x32F
250mA	0.25M5x20T <sup>4</sup>	0.25M5x20M	0.25M5x20F <sup>4</sup>			0.315M5x25M		0.315M6.3x32T <sup>4</sup>	0.315M6.3x32F
315mA	0.315M5x20T <sup>4</sup>	0.315M5x20M	0.315M5x20F <sup>4</sup>						
400mA	0.4M5x20T <sup>4</sup>	0.4M5x20M	0.4M5x20F <sup>4</sup>			0.4M5x25M		0.4M6.3x32T <sup>4</sup>	0.4M6.3x32F
500mA	0.5M5x20T <sup>4</sup>	0.5M5x20M	0.5M5x20F <sup>4</sup>			0.5M5x25M		0.5M6.3x32T <sup>4</sup>	0.5M6.3x32F
630mA	0.63M5x20T <sup>4</sup>	0.63M5x20M	0.63M5x20F <sup>4</sup>			0.63M5x25M		0.63M6.3x32T <sup>4</sup>	0.63M6.3x32F
700mA	0.7M5x20T <sup>4</sup>	0.7M5x20M	0.7M5x20F <sup>4</sup>			0.8M5x25M		0.7M6.3x32T <sup>4</sup>	0.7M6.3x32F
800mA	0.8M5x20T <sup>4</sup>	0.8M5x20M	0.8M5x20F <sup>4</sup>					0.8M6.3x32T <sup>4</sup>	0.8M6.3x32F
1.0A	1.0M5x20T <sup>4</sup>	1.0M5x20M	1.0M5x20F <sup>4</sup>			1.0M5x25M		1.0M6.3x32T <sup>4</sup>	1.0M6.3x32F <sup>4</sup>
1.25A	1.25M5x20T <sup>4</sup>	1.25M5x20M	1.25M5x20F <sup>4</sup>			1.25M5x25M		1.25M6.3x32T <sup>4</sup>	1.25M6.3x32F <sup>4</sup>
1.4A	1.4M5x20T <sup>4</sup>	1.4M5x20M				1.6M5x25M			
1.6A	1.6M5x20T <sup>4</sup>	1.6M5x20M	1.6M5x20F <sup>4</sup>					1.6M6.3x32T <sup>4</sup>	1.6M6.3x32F <sup>4</sup>
2.0A	2.0M5x20T <sup>4</sup>	2.0M5x20M	2.0M5x20F <sup>4</sup>			2.0M5x25M		2.0M6.3x32T <sup>4</sup>	2.0M6.3x32F <sup>4</sup>
2.5A	2.5M5x20T <sup>4</sup>	2.5M5x20M	2.5M5x20F <sup>4</sup>			2.5M5x25M		2.5M6.3x32T <sup>4</sup>	2.5M6.3x32F <sup>2,4</sup>
3.15A	3.15M5x20T <sup>4</sup>	3.15M5x20M	3.15M5x20F <sup>4</sup>			3.15M5x25M		3.15M6.3x32T <sup>4</sup>	3.15M6.3x32F <sup>2,4</sup>
4.0A	4.0M5x20T <sup>4</sup>	4.0M5x20M	4.0M5x20F <sup>4</sup>			4.0M5x25M		4.0M6.3x32T <sup>4</sup>	4.0M6.3x32F <sup>2,4</sup>
5.0A	5.0M5x20T <sup>4</sup>	5.0M5x20M	5.0M5x20F <sup>4</sup>			5.0M5x25M		5.0M6.3x32T <sup>4</sup>	5.0M6.3x32F <sup>3,4</sup>
6.3A	6.3M5x20T <sup>4</sup>	6.3M5x20M	6.3M5x20F <sup>4</sup>			6.3M5x25M		6.3M6.3x32T <sup>4</sup>	6.3M6.3x32F <sup>3,4</sup>
7.0A								7.0M6.3x32T <sup>4</sup>	7.0M6.3x32F <sup>3</sup>
8.0A	8.0M5x20T <sup>1</sup>	8.0M5x20M	8.0M5x20F <sup>1</sup>					8.0M6.3x32T <sup>4</sup>	8.0M6.3x32F <sup>3</sup>
10.0A	10.0M5x20T <sup>1</sup>	10.0M5x20M	10.0M5x20F <sup>1</sup>			8.0M5x25M <sup>1</sup>		10.0M6.3x32T <sup>4</sup>	10.0M6.3x32F <sup>3</sup>
12.5A	12.5M5x20T <sup>1</sup>	12.5M5x20M <sup>1</sup>	12.5M5x20F <sup>1</sup>			10.0M5x25M <sup>1</sup>		12.5M6.3x32T <sup>4</sup>	12.5M6.3x32F <sup>3</sup>
16.0A	16.0M5x20T <sup>1</sup>	16.0M5x20M <sup>1</sup>	16.0M5x20F <sup>1</sup>			16.0M5x25M <sup>1</sup>		16.0M6.3x32T <sup>4</sup>	16.0M6.3x32F <sup>3</sup>
20.0A	20.0M5x20T <sup>1</sup>	20.0M5x20M <sup>1</sup>	20.0M5x20F <sup>1</sup>					20.0M6.3x32T <sup>4</sup>	20.0M6.3x32F <sup>3</sup>
	Std. Pk. 10					Std. Pk. 10		Std. Pk. 10	

1 Not standard rating.  
2 Rated Voltage 150V.  
3 Rated Voltage 60V.  
4 UL recognized version available upon request.



# PCB Mounting Tracks

Mount standard or custom printed circuit boards in Mounting Tracks which can be conveniently DIN rail or panel mounted in your control panel or cabinet. These are the same tracks used for Altech interface modules. We now make them available to you to house and protect your custom boards, etc. Tracks are easily cut to size or can be ordered pre-cut to specific lengths. They are easily assembled from standard components and snap onto 35mm DIN rail or can be panel mounted.

Each track has two sets of printed circuit board guides to accept two alternate board widths.

End Sections hold printed circuit boards securely in place and keep out foreign objects.

## MOUNTING

When mounting extrusions on DIN rail, order two or more DIN Rail mounting feet. These feet slide into grooves on the extrusion. Then attach two DIN Rail Mount End Sections with help of EPS screws.

To panel mount, order two Panel Mount End Sections (and EPS screws), each with an integral mounting flange with a 6 x 8mm (.24 x .32 in.) hole slot.

If desired, tracks can be direct mounted using double sided tape. Order two DIN rail mount end sections (and EPS screws).

- Standard Lengths: 1m (3'-3") or 2m (6'-6")
- Track Material: PVC
- Temperature Limit:  
Short Term - 80°C (176°F)  
Continuous - 70°C (158°F)
- End Section, Foot Material: Polyamide
- Preassembled, Precut Lengths Available
- Tracks Accept Standard MT2 Marking Tags

\* Green color available on request.  
Contact Altech for more information.

## Narrow Mounting Track Extrusion and Components

For PC Board Widths 73mm (2.9 in.)

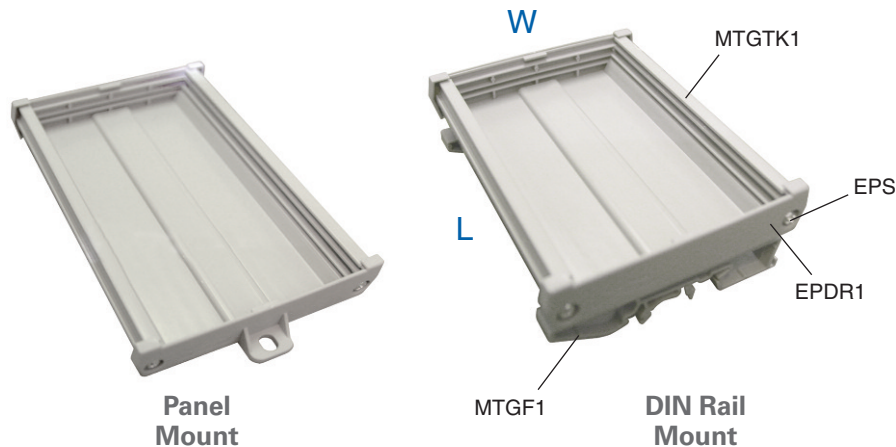

- Mounting Track
- 1 meter, grey
  - 2 meter, grey
  - 1 meter, green\*
  - 2 meter, green\*

### Accessories

	Cat. No.	Std. Pk.
DIN Rail Mount End Section, grey	EPDR1	100
DIN Rail Mount End Section, green*	EPDR1/G	100
DIN Rail Mounting Foot, grey	MTGF1	100
DIN Rail Mounting Foot, green*	MTGF1/G	100
Panel Mount End Section, grey	EPDP1	100
Panel Mount End Section, green*	EPDP1/G	100
DIN Rail / Panel Mount End Section Screws #4x1/2", Phillips Pan head (2 required per end section)	EPS	200
Marking Tags	MT2	100

Cat. No.	Std. Pk.
MTGTK1/1M	5
MTGTK1	5
MTGTK1/1M/G	5
MTGTK1/G	5

## Sizing Information

Printed Circuit Board Width	
Track Type	High Guide (HG)
MTGTK1	73 ± 1mm (2.9 ± 0.05 in.)
MTGTK2	110 ± 1mm (4.3 ± 0.05 in.)

Mounting Track Extrusion "Cut-to-Size" Formula
Extrusion Length = Printed Circuit Board Length - 4.5mm (.175 in.)

**Wide Mounting Track  
Extrusion and Components**

For PC Board Widths 110mm (4.9 in.)

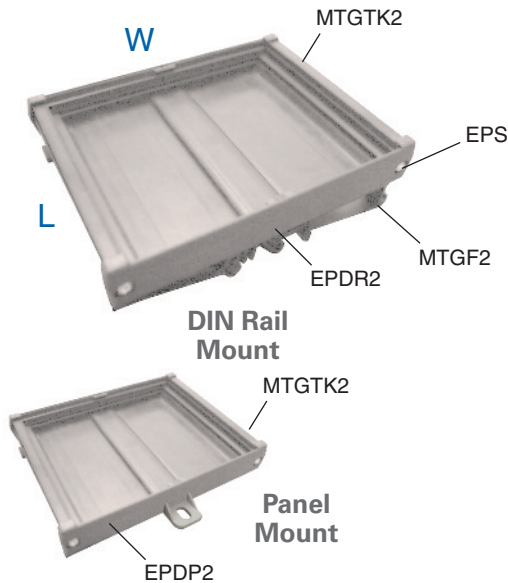

**Narrow Mounting Track**

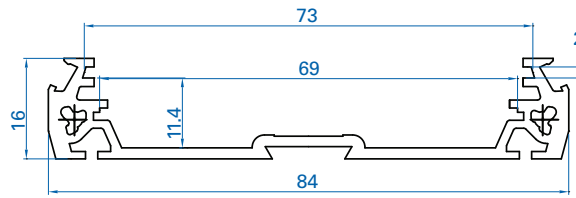

PCB MOUNTING TRACK (73 mm)

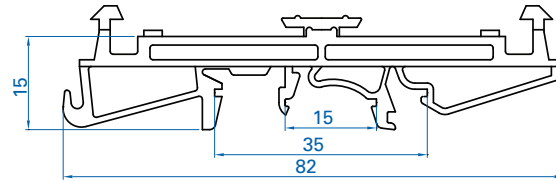

DIN RAIL MOUNTING FOOT (73mm)

**Wide Mounting Track**

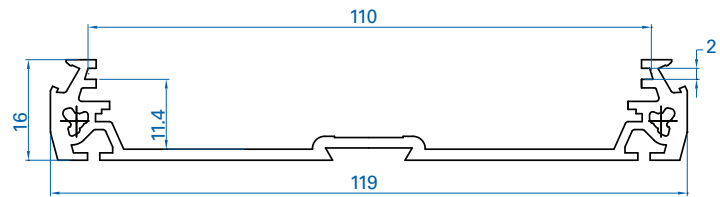

PCB MOUNTING TRACK (110 mm)

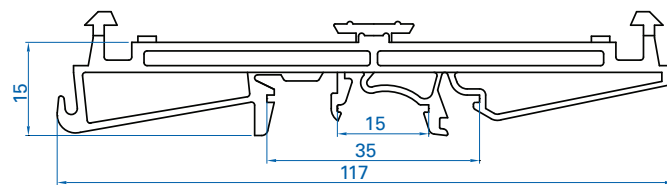

DIN RAIL MOUNTING FOOT (110mm)

Cat. No.	Std. Pk.
MTGTK2/1M	5
MTGTK2	5
MTGTK2/1M/G	5
MTGTK2/G	5
EPDR2	100
EPDR2/G	100
MTGF2	100
MTGF2/G	100
EPDP2	100
EPDP2/G	100
EPS	200
MT2	100

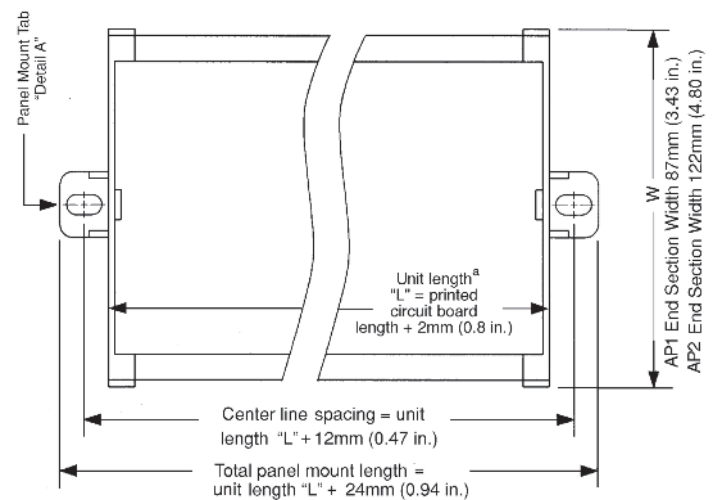
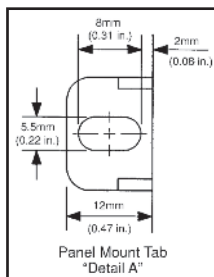

<sup>a</sup>Also applies for DIN Rail Mount Unit

# Receptacles

Features:

- DIN Rail, Panel Mount or Wall Mount
- Rating: 15A/125V AC
- Finger Protection: IP54
- Available in 3 colors.

## PANEL MOUNT

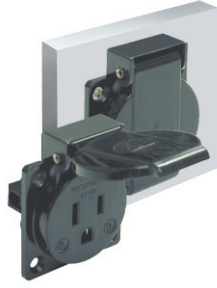



## WALL MOUNT



## DIN RAIL MOUNT



External Dimension (HxWxL mm)	36.5 x 61.5 x 50	50 x 71 x 53.5	58.5 x 84 x 53.5
Stripping Length	10 mm	10 mm	10 mm
Insulation Material	Thermoplastic	Thermoplastic	Thermoplastic
Type of Connection	3 screw clamps	3 screw clamps	3 screw clamps
Approvals*	 E154664	 E154664	 E154664
Voltage Rating	125 V	125 V	125 V
Current Rating	15 A	15 A	15 A

Cat. No.	Std. Pk.
----------	----------

Cat. No.	Std. Pk.
----------	----------

Cat. No.	Std. Pk.
----------	----------

Complete Kit:

	Cat. No.	Std. Pk.	Cat. No.	Std. Pk.	Cat. No.	Std. Pk.
Blue	PMRBU	1	WMRBU	1	DMRBU	1
Gray	PMRGR	1	WMRGR	1	DMRGR	1
Black	PMRBA	1	WMRBA	1	DMRBA	1

Optional Accessory	Cat. No.	Std. Pk.	Optional Accessory	Cat. No.	Std. Pk.	Optional Accessory	Cat. No.	Std. Pk.
Sealing Gasket for Panel Mount Receptacles	SEALGASK	1	Includes Sealing Gasket			Includes Sealing Gasket		

\*UL approval applies to outlet only, not enclosure or DIN rail clip.



**PANEL MOUNT**

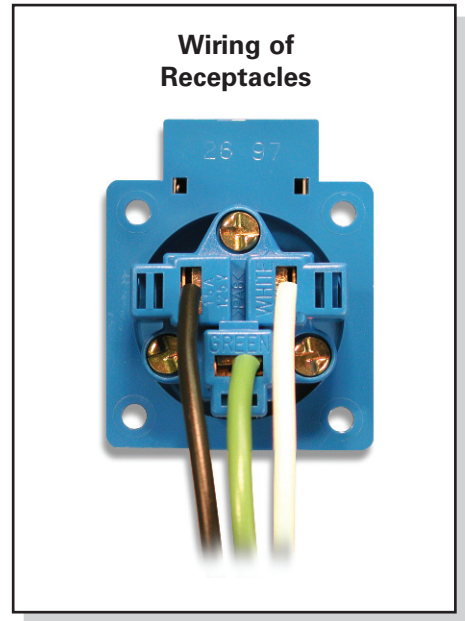
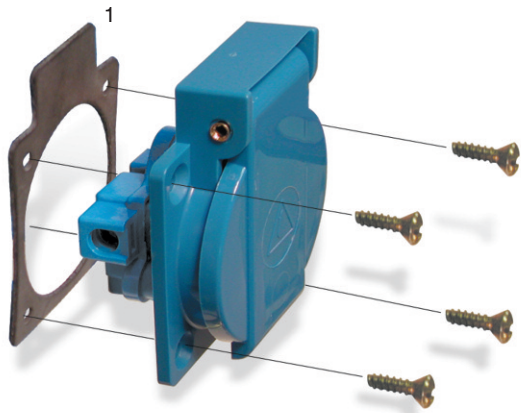

**WALL MOUNT**

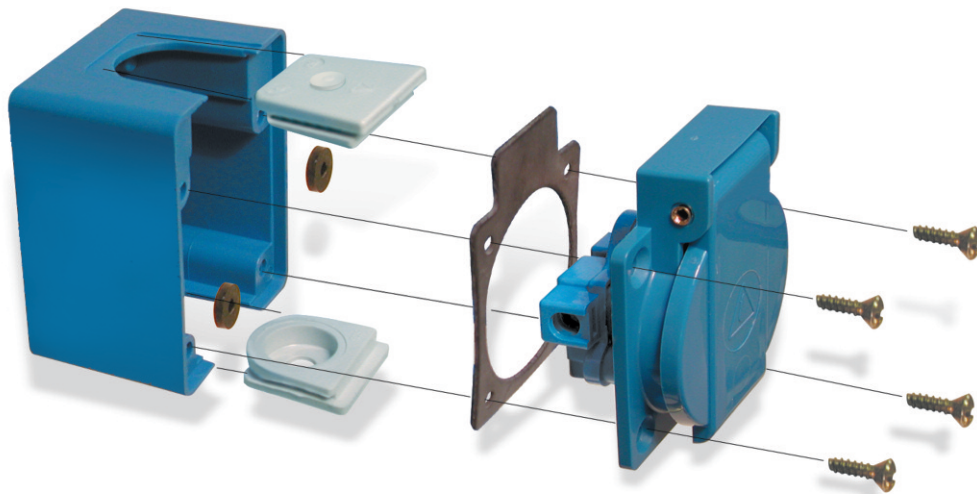

**DIN RAIL MOUNT**

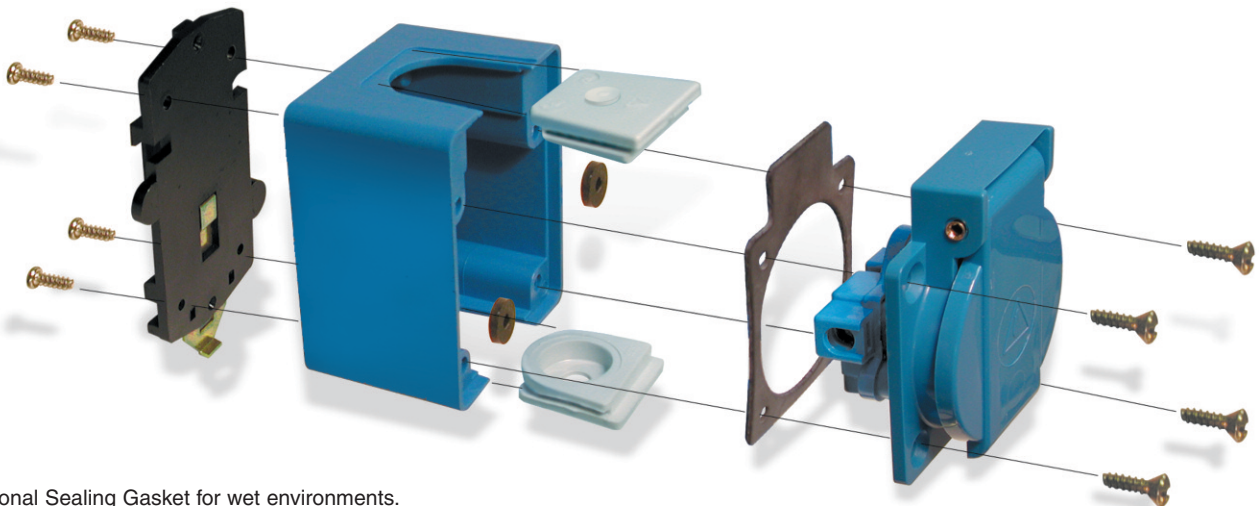

<sup>1</sup> Optional Sealing Gasket for wet environments.

# Altech Universal Digital Multi-Timer

Altech's AMT-Series of Universal Digital Multi-Timers comprises 4 models featuring 8 or 18 timer functions to offer highest flexibility in controlling operations. The time range is adjustable from 0.1s to 999h. An LCD display shows current Run time information.

## Features

- Multifunctional Timer (8 or 18 Functions)
- Universal Voltage 24~265 VAC/ DC
- Wide Time Range: 0.1s ~ 999h
- 3 Digit LCD Display for Preset Time and Run Time
- DIN Rail Mounted
- 17.5mm Width



## Digital Timers

Cat. No.	AMT8-S1	AMT8-D2	AMT12-S1	AMT12-D2
Output Contacts	1 C/O	2 NO	1 C/O	2 NO
Functions [setting mode]	8	8	18	18
	1) ON Delay [F]		1) ON Delay [Q]	
	2) Cyclic OFF/ ON [b]		2) Cyclic OFF/ ON [1]	
	3) Cyclic ON/ OFF [c]		3) Cyclic ON/ OFF [2]	
	4) Signal ON/ OFF [d]		4) Impulse on Energizing [3]	
	5) Signal OFF Delay [E]		5) Accumulative Delay on Signal [4]	
	6) Interval [F]		6) Accumulative Delay on Inverted Signal [5]	
	7) Signal OFF/ ON [G]		7) Accumulative Impulse on Signal [6]	
	8) One Shot Output [H]		8) Signal ON Delay [7]	
			9) Inverted Signal ON Delay [8]	
			10) Signal OFF Delay [9]	
			11) Impulse ON/ OFF [A]	
			12) Signal OFF/ ON [b]	
			13) Leading Edge Impulse 1 [c]	
			14) Leading Edge Impulse 2 [d]	
			15) Trailing Edge Impulse 1 [E]	
			16) Trailing Edge Impulse 2 [F]	
			17) Delayed Impulse [G]	
			18) Inverted Signal ON Delay 2 [8]	

## Specifications

Supply Voltage	24 - 265 VAC/ DC (50, 60Hz)
Power Consumption	10 VA max.
Timing Range	0.1s ~ 999h
Reset Time	200ms max.
Repeat Accuracy	±0.5%
Output Contact Rating	8A @ 240 VAC/ 24 VDC (resistive)
Electrical Life	10,000 switching cycles
Mechanical Life	2,000,000 switching cycles
AC-15 Rating	Rated Voltage (Ue): 125/ 240V, Rated Current (Ie): 3/1.5A
DC-13 Rating	Rated Voltage (Ue): 125/ 250V, Rated Current (Ie): 2/0.22/0.1A
Operating Temperature	-10°C ~ +55°C (+14°F ~ 131°F)
Storage Temperature	-20°C ~ +65°C (-4°F ~ 149°F)
Weight	85g (0.14lb.)
Protection Enclosure	IP30
Protection Terminals	IP20
Torque	0.40 Nm (3.5 lb.in.)
Terminal Wire Size	0.3-2.5 mm <sup>2</sup> (22-14 AWG)

## Dimensions

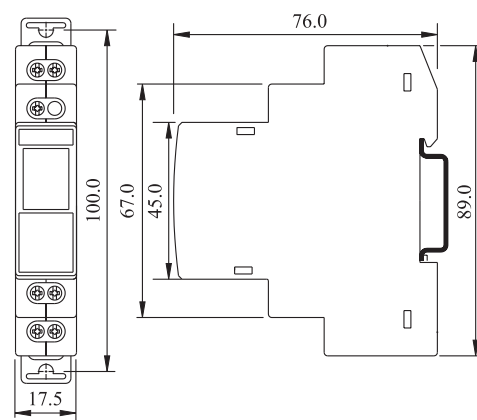

## Connection Diagrams

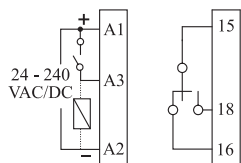

AMT8-S1, AMT12-S1

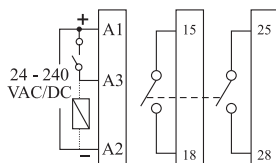

AMT8-S2, AMT12-S2

**Functional Diagrams for AMT12-S1 and AMT12-D2**

**ON DELAY [0]**

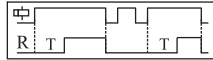

On application of supply voltage, the preset delay time period starts. On completion of the preset time, the output is switched ON and remains ON till the supply voltage is present

**CYCLIC OFF/ON {OFF Start, (Sym, Asym)} [1]**



On application of supply voltage, the output is initially switched OFF for the preset 'OFF' time duration (TOFF) after which it is switched ON for the preset 'ON' time duration (TON). This cycle repeats and continues till the supply is present.

**CYCLIC ON/OFF {ON start, (Sym, Asym)} [2]**



On application of supply voltage, the output is instantly switched ON for the preset time duration (TON) after which it is switched OFF for the preset 'OFF' time duration (TOFF). This cycle repeats and continues till the supply is present.

**IMPULSE ON ENERGIZING [3]**

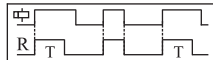

On application of supply voltage, the output is instantly switched ON for the preset time duration (T) after which it is switched OFF.

**ACCUMULATIVE DELAY ON SIGNAL [4]**

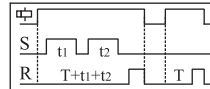

On application of supply voltage, the preset timing duration commences. When input signal is applied the timing pauses and resumes only when the input signal is removed. The output is switched ON at the end of the preset time duration (T).

**ACCUMULATIVE DELAY ON INVERTED SIGNAL [5]**

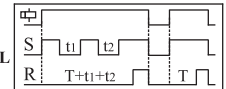

On application of supply voltage and input signal, the preset timing duration commences. When the signal is removed the timing pauses and resumes when the signal is applied. The output is switched ON at the end of the preset time duration (T).

**ACCUMULATIVE IMPULSE ON SIGNAL [6]**

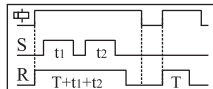

When supply is ON, R energizes. When switch S is closed timing is suspended and remains suspended till switch S is opened again. Interrupting supply resets timer.

**SIGNAL ON DELAY [7]**

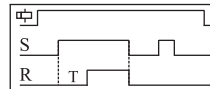

On application of input signal, the preset delay time period starts. On completion of the preset time, the output is switched ON and remains ON till the input signal is present

**INVERTED SIGNAL ON DELAY [8]**

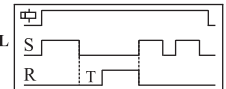

On application of supply voltage, the preset delay time period starts. When input signal is applied, the timing pauses & resumes only when the signal is removed. On completion of the preset time, the output is switched ON.

**SIGNAL OFF DELAY [9]**

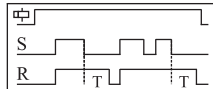

On application of supply voltage and input signal, the output is switched ON. When the signal is removed the preset time duration commences & the output is switched OFF at the end of the time duration.

**IMPULSE ON/OFF [A]**

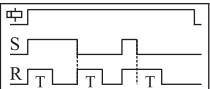

On application or removal of input signal, the output is switched ON & the preset time duration (T) commences. On completion of the time duration the output is switched OFF. When timing commences, changing the state of the input signal resets the time.

**SIGNAL OFF/ON [b]**

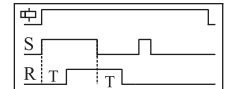

On application of input signal, the preset delay time period (T) starts. On completion of the preset time, the output is switched ON. On removal of input signal, the preset time period starts again and the output is switched ON when the preset time duration is complete.

**LEADING EDGE IMPULSE1 [C]**

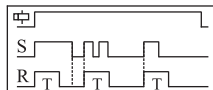

On application of input signal the output is immediately switched ON. The output remains ON for the preset time duration (T) after which it is switched OFF. If the input signal is removed during the preset time, the output remains unaffected.

**LEADING EDGE IMPULSE2 [d]**

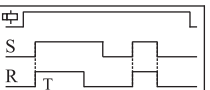

On application of input signal the output is immediately switched ON. The output remains ON for the preset time duration (T) after which it is switched OFF. If the input signal is removed during the preset time, the output is immediately switched OFF.

**TRAILING EDGE IMPULSE1 [E]**

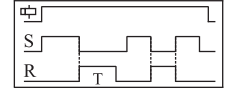

When the input signal to the timer is removed, the output is immediately switched ON for the preset time duration (T) after which it is switched OFF. If the input signal is applied during the preset time, the output is immediately switched OFF.

**TRAILING EDGE IMPULSE2 [F]**

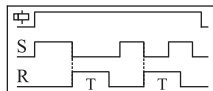

When the input signal to the timer is removed, the output is immediately switched ON for the preset time duration (T) after which it is switched OFF. If the input signal is applied during the preset time, the output remains unaffected.

**DELAYED IMPULSE [G]**

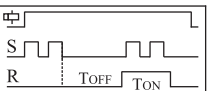

when switch S is closed, TOFF starts. Relay energizes at the end of TOFF period. Then, TON starts irrespective of signal level and relay de-energizes at the end of TON period.

**Functional Diagrams for AMT8-S1 and AMT8-D2**

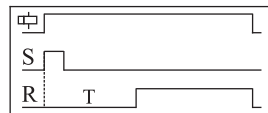

**ON DELAY (A)**



**CYCLIC OFF/ON {OFF Start, (Sym, Asym)} (b)**



**CYCLIC ON/OFF {ON Start, (Sym, Asym)} (C)**

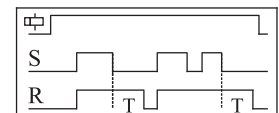

**SIGNAL ON/OFF (d)**

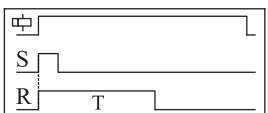

**SIGNAL OFF DELAY (E)**

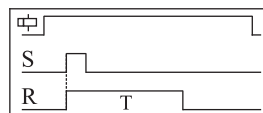

**INTERVAL (F)**

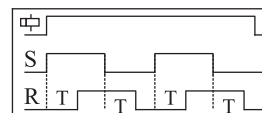

**SIGNAL OFF / ON (G)**

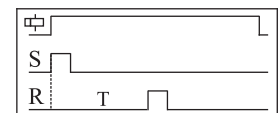

**ONE SHOT OUTPUT (H)**

**Note:** 1. For Power-On operation (P) connect the terminal B1 to A1 permanently.  
2. If the Signal (S) changes during the Timer Duration (T), it does not change the output relay but re-triggering takes places and the Timer Duration is extended.