

## Fixed Machined Contact Connector

- Standards:
- UL File: E119881
  - Connectors according to MIL C24308

### SPECIFICATIONS:

#### MATERIALS AND PLATINGS

<b>Shells</b>	Steel yellow chromated over zinc or tinned steel with or without dimples on plug connector
<b>Insulator</b>	Glass-filled thermoplastic, UL 94V-0
<b>Rear Insert</b>	Brass, 118µ" up to 197µ" (3µm up to 5µm) tinned over nickel 78µ" up to 118µ" (2µm up to 3µm)
<b>Boardlock</b>	Tin-lead plating 157µ" up to 236µ" (4µm up to 6µm) over nickel 78µ" up to 118µ" (2µm up to 3µm)
<b>Screwlock</b>	Brass, 236µ" up to 394µ" (6µm up to 10µm) tinned over nickel 78µ" up to 118µ" (2µm up to 3µm)
<b>Contacts</b>	D: brass DF: pin = brass Socket = copper alloy
<b>Right Angle Version</b>	Selective gold in mating area over 78µ" up to 118µ" (2µm up to 3µm) nickel; 118µ" up to 197µ" (3µm up to 5µm) tin-lead on termination area over 78µ" up to 118µ" (2µm up to 3µm) nickel
<b>Straight Version</b>	Full gold plating over 78µ" up to 118µ" (2µm up to 3µm) nickel

#### ELECTRICAL DATA

<b>Current Rating</b>	7.5 A
<b>Voltage Rating</b>	300 V AC/rms 50Hz
<b>Withstanding Voltage</b>	1000V AC/rms 50Hz for one minute
<b>Insulation Resistance</b>	5000MΩ
<b>Contact Resistance</b>	D: 8.5mΩ max. DF: 5mΩ max.

#### CLIMATIC DATA

<b>Operating Temperature</b>	D: -67°F (-55°C) to +185°F (85°C), peak at 257°F (125°C) DF: -67°F (-55°C) to + 257°F (125°C)
------------------------------	--

#### MECHANICAL DATA

No. of Contacts	Mate (max.)	Unmate (min.)
9 (size E)	6.74 (3.05)	0.79 (0.36)
15 (size A)	11.24 (5.09)	1.01 (0.46)
25 (size B)	18.66 (8.44)	1.8 (0.81)
37 (size C)	27.65 (12.51)	2.47 (1.1)
50 (size D)	32.38 (14.65)	3.56 (1.6)

INCHES (MM)

## D-DF SERIES

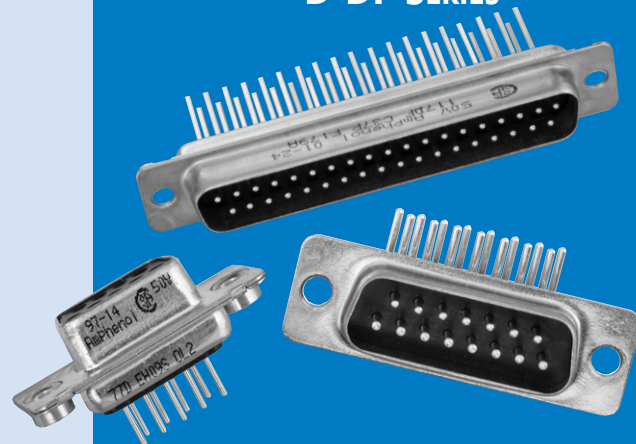

The Amphenol SD series features precision formed contacts, and 4 finger boardlocks.

This series gives you Amphenol's high standards of quality and reliability to meet all of your commercial requirements.

- Industrial
- Telecom
- Any industry standard I / O connections

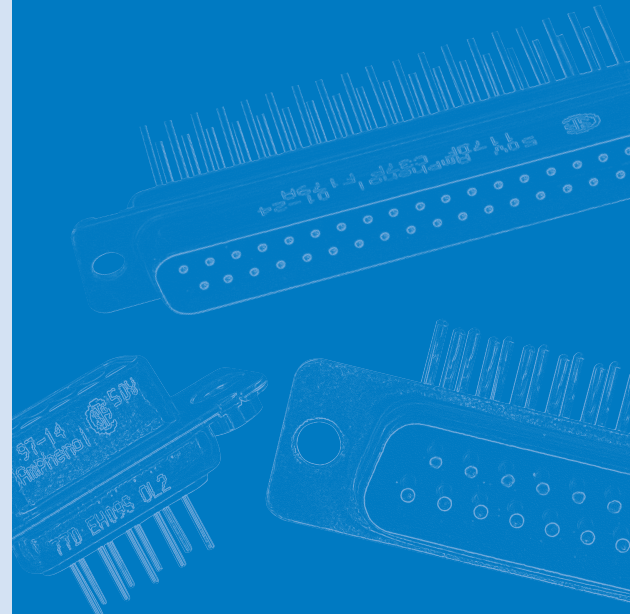

Without bracket

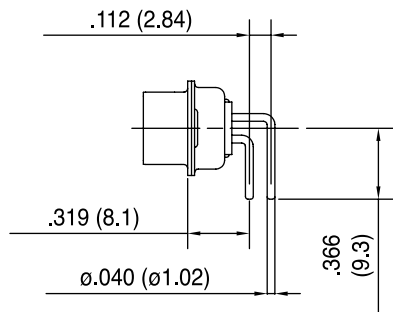

C

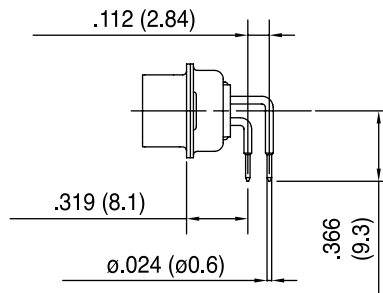

A4

Plastic bracket

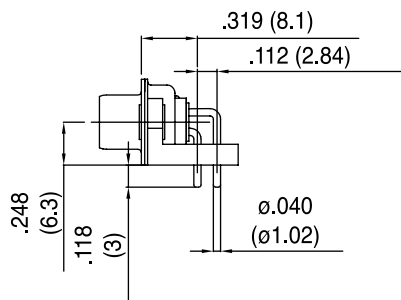

AJ3

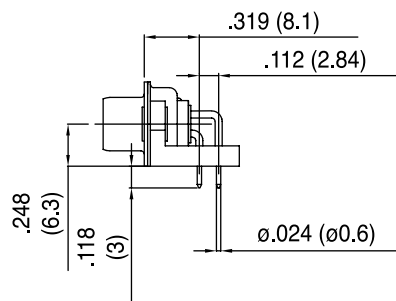

AJ4

Metal bracket

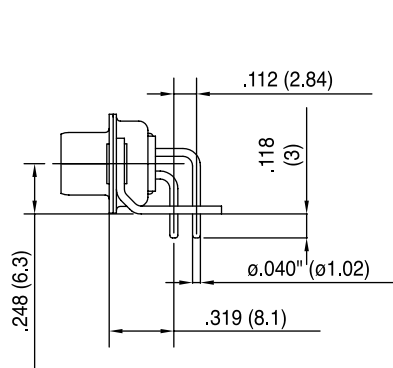

A

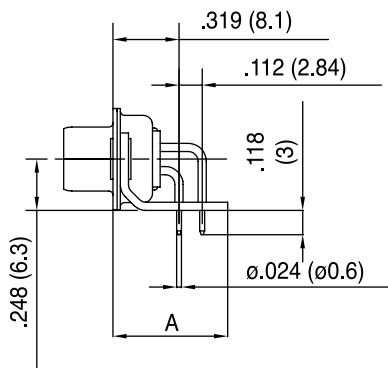

AM4 : A=.519 (13.2)  
AZ4 : A=.453 (11.5)

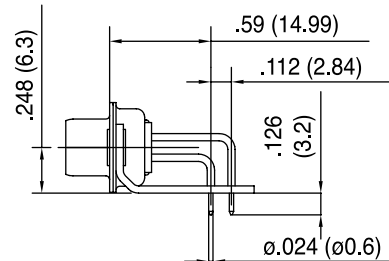

AM4B

50 contacts

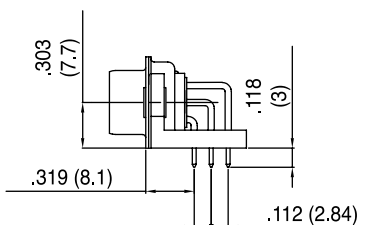

Without bracket

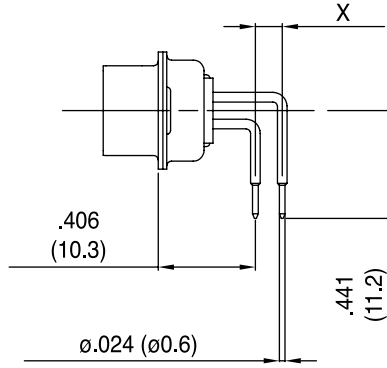

**1AON : X= .100 (2.54)**  
**1BON : X= .112 (2.84)**

Plastic bracket

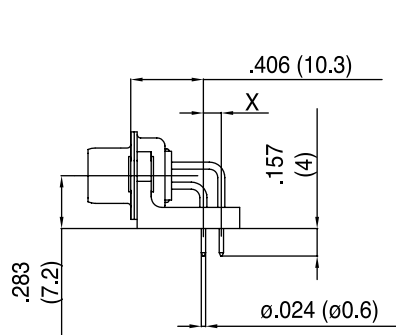

**1APN : X= .100 (2.54)**  
**1BPN : X= .112 (2.84)**

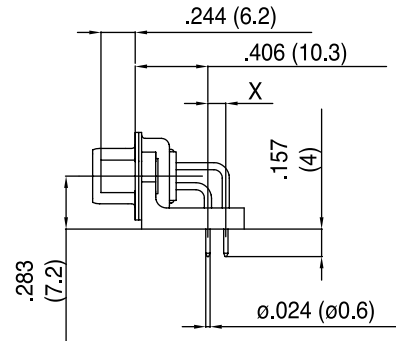

**1AUN : X= .100 (2.54)**  
**1BUN : X= .112 (2.84)**

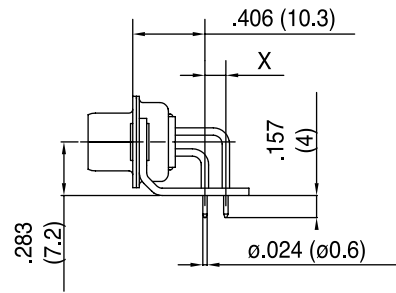

**1AMN : X= .100 (2.54)**  
**1BMN : X= .112 (2.84)**

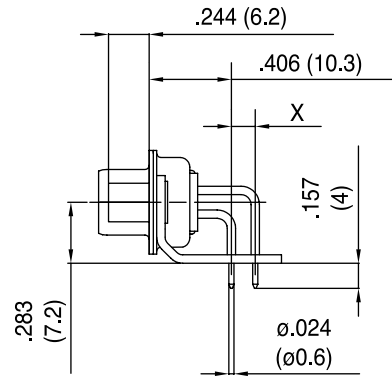

**1ATN : X= .100 (2.54)**  
**1BTN : X= .112 (2.84)**

50 contacts

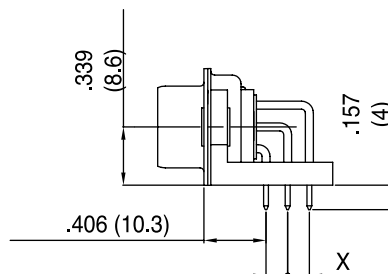

INCHES (MM)

Solder cup

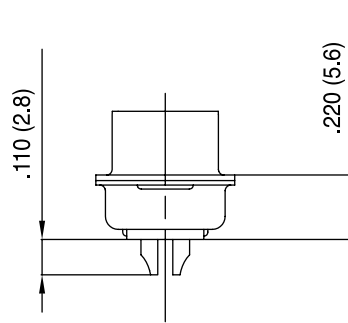

Wire Wrap

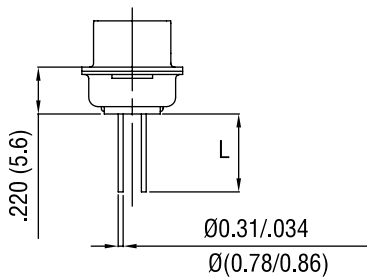

Termination	Nb of wraps	L
F179	2	.378 (9.6)
F179A	3	.512 (13)

Straight PCB

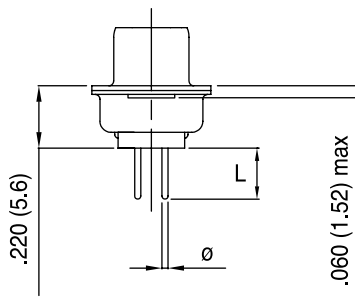

Termination	Ø	L
U	.024 (0.6)	.126 (3.2)
V	.040 (1.02)	.095 (2.4)
T	.024 (0.6)	.157 (4)
OL2	.02 (0.6)	.217 (5.5)

Grounding tabs

For straight termination

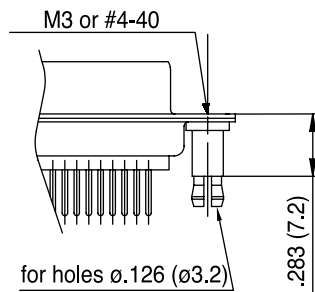

RM5

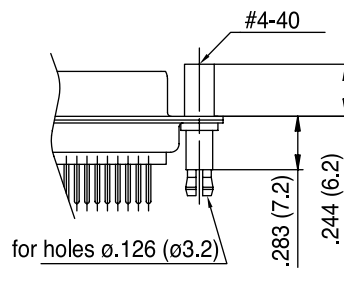

RM8

For R/A termination

FOR PCB .062 (1.6)

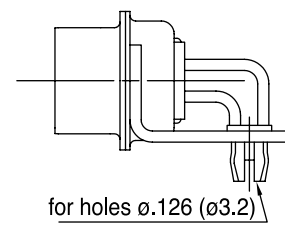

RM6

*For straight and R/A termination*

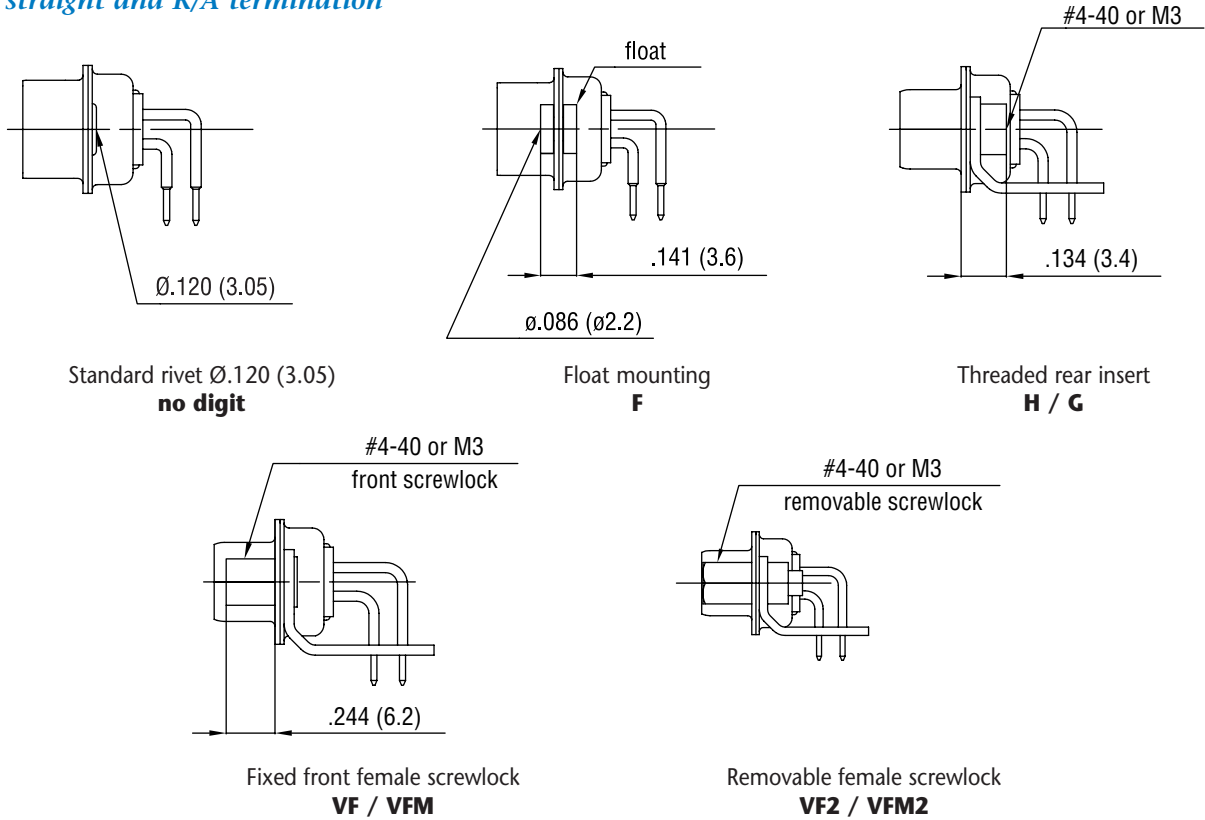

**RECOMMENDED PCB LAYOUT**

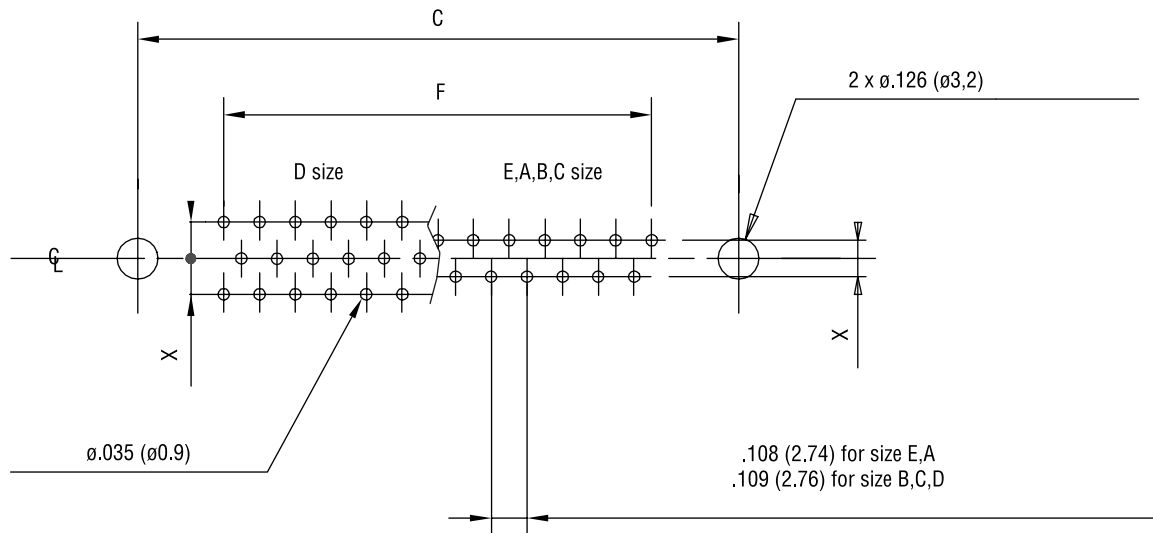

For straight PCB: X = .112 (2.84)  
 For right angle PCB: MIL: X = .112 (2.84)  
 European: X = .100 (2.54), .112 (2.84) in option

	size E	size A	size B	size C	size D
<b>C <math>\pm .004</math> (0.1)</b>	.984 (25)	1.311 (33.3)	1.85 (47)	2.5 (63.5)	2.406 (61.1)
<b>F <math>\pm .002</math> (0.05)</b>	.431 (10.96)	.755 (19.18)	1.304 (33.12)	1.956 (49.68)	1.74 (44.2)

INCHES (MM)

ORDERING INFORMATION

XXXXX X X XX X XXXXX XXXX X

8µ" (0.2µm)	<b>17D:</b> yellow chromated shell <b>77D:</b> tinned shell for receptacle <b>717D:</b> tinned shell + dimples for plug
20µ" (0.5µm)	<b>17DF:</b> yellow chromated shell <b>77DF:</b> tinned shell for receptacle <b>717DF:</b> tinned shell + dimples for plug
30µ" (0.76µm)	<b>117DF:</b> yellow chromated shell <b>177DF:</b> tinned shell for receptacle <b>777DF:</b> tinned shell + dimples for plug

Shell size: E, A, B, C, D

Mounting Options:

- H rear insert 4-40
- G rear insert M3
- F float mounting
- no digit standard rivet .122 (ø 3.1)
- \*H, G must also be used to specify the threading of RM5 grounding tabs.

Configuration: 09, 15, 25, 37, 50

Contact type:

- P pin
- S socket

For specific product

Grounding tabs:

- RM5 for straight PCB mounting\*
- RM8 for straight PCB mounting + female lock
- RM6 for right angle PCB mounting
- VF front screwlock 4-40
- VFM front screwlock M3
- VF2 removable screwlock 4-40
- VF2M removable screwlock M3

Termination:

solder cup: no digit

Wire Wrap:

- F179 length .378 (9.6)
- F179A length .512 (13)

Straight PCB:

- U length .126 (3.2) tail ø.024 (ø0.6)
- V length .094 (2.4) tail ø.040 (ø1.02)
- T length .157 (4) tail ø.024 (ø0.6)
- OL2 length .216 (5.5) tail ø.024 (ø0.6)

Right Angle Connector:

- MIL footprint
- without bracket: C tail ø.040 (ø1.02)
  - A4 tail ø.024 (ø0.6)
- plastic bracket:
- AJ3 tail ø.040 (ø1.02)
  - AJ4 tail ø.024 (ø0.6)
- metal bracket:
- A tail ø.040 (ø1.02)
  - AM4 A ø.519 (13.2)
  - AZ4 A ø.453 (11.5)
  - AM4B footprint ø.590 (14.99)

European footprint

- without bracket:
- 1AON X .100 (2.54)
  - 1BON X .112 (2.84)
- plastic bracket:
- 1APN X .100 (2.54)
  - 1BPN X .112 (2.84)
  - 1AUN X .100 (2.54)
  - 1BUN X .112 (2.84)
- metal bracket:
- 1AMN X .100 (2.54)
  - 1BMN X .112 (2.84)
  - 1ATN X .100 (2.54)
  - 1BTN X .112 (2.84)

Standard options

For special request, please consult factory

For Filtered D-Sub, see page 56.