

CONFIGURATION	PART NUMBER	CONTACT TYPE
ROTATABLE 90 DEGREE RECEPTACLE, 17 POSITION, TYPE: 17E (CW)	MA1RAE1701	SOCKET/PIN

DIMENSIONS

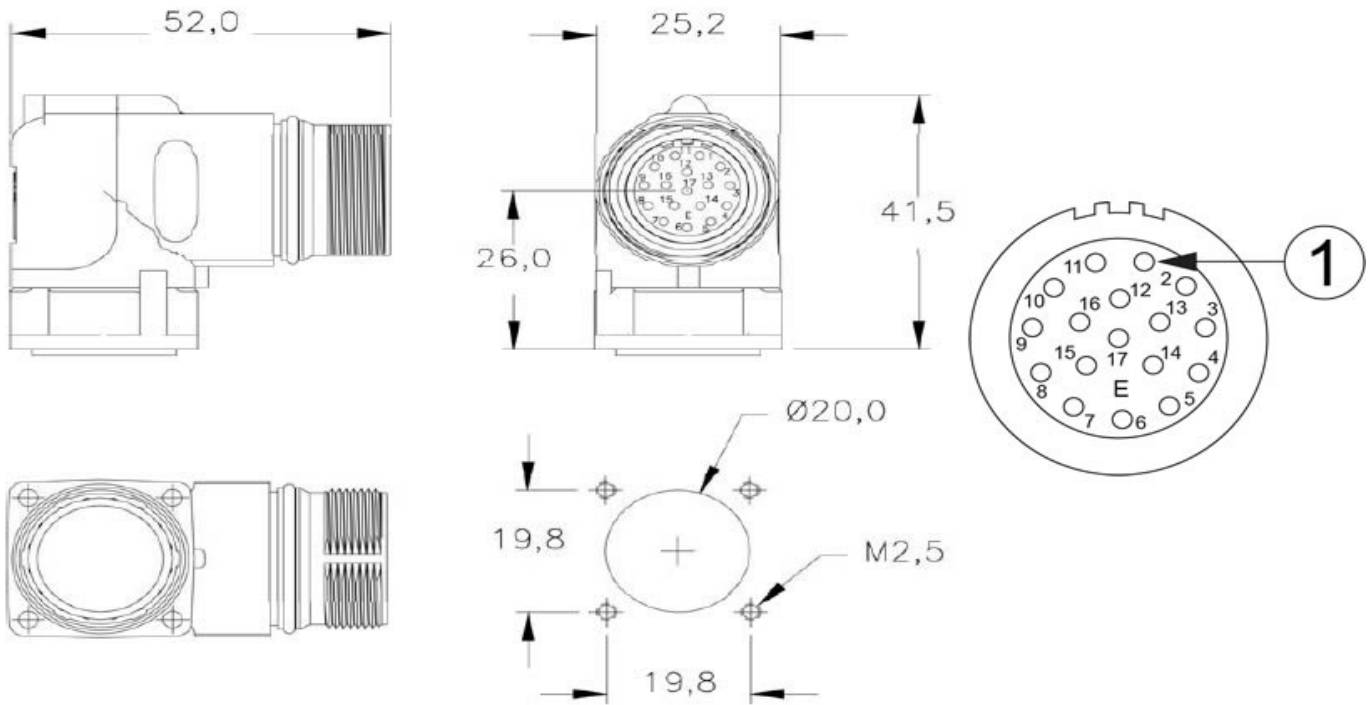

TECHNICAL DATA

TEMPERATURE RANGE:	-20C to +130C
PROTECTION:	IP 67 (PLUGGED CONDITION)
DEGREE OF PROTECTION:	3
OVER VOLTAGE CATEGORY:	III
HOUSING BODY:	ZINC DIE-CAST
COUPLING NUT:	BRASS, NICKEL-PLATED
INSULATION INSERTS:	PA66, UL 94 / VO
CONTACTS:	BRASS, GOLD-PLATED
SEALS:	DUPONT VITON
MAX CURRENT:	9A
CONTACT SIZE:	17 x 1.0mm
MAXIMUM VOLTAGE:	125V AC/DC
CONTACT RESISTANCE:	<5
TEST VOLTAGE: (BETWEEN CONTACTS)	2500V
MAXIMUM MATING CYCLES:	>50