

MATERIAL

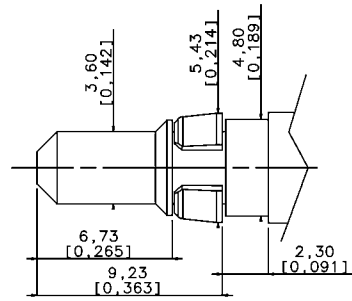

PIN CONTACT Cu Zn
 SOCKET CONTACT Cu Ni
 RETAINING CLIP Thermoplastic
 SURFACE PLATING Au = 0.5 um

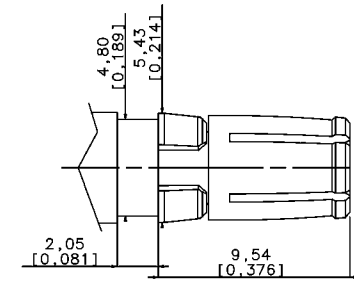

HIGH POWER PLUG

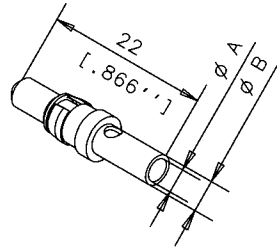

CRIMP VERSION VERSION A SERTIR

	CURRENT	PUISSANCE		φ A	φ B		
4W540 30R	L17DM53745-208	10A		1.8	2.55	L17DM53744-207	4W550 30R
4W540 20R	L17DM53745-207	20A		2.8	3.7	L17DM53744-206	4W052 16P
4W042 36P	L17DM53745-204	30A		3.76	4.7	L17DM53744-204	4W052 36P
4W540 00R	L17DM53745-201	40A		4.8	5.6	L17DM53744-201	4W052 06P

HIGH POWER JACK

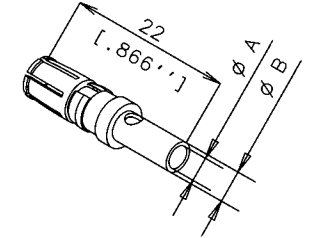

SOLDER VERSION VERSION A SOUDER

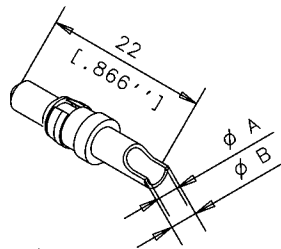

	CURRENT	PUISSANCE		φ A	φ B		
4W040 30C	L17DM53745-8	10A		1.8	2.55	L17DM53744-7	4W050 30C
4W040 20C	L17DM53745-7	20A		2.8	3.7	L17DM53744-6	4W050 20C
4W040 00C	L17DM53745-1	40A		4.8	5.6	L17DM53744-1	4W050 00C

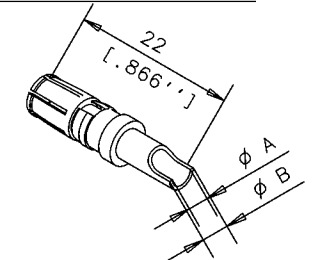

CRIMP SHORT VERSION VERSION COURTE A SERTIR

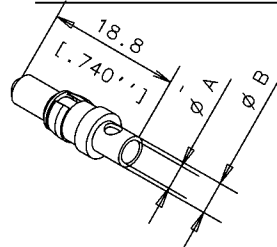

	CURRENT	PUISSANCE		φ A	φ B		
4W042 29R	L17DM53745-218	10A		1.8	2.55	L17DM53744-217	4W050 29R
4W042 19R	L17DM53745-217	20A		2.8	3.7	L17DM53744-216	NC
NC	L17DM53745-211	40A		4.8	5.6	L17DM53744-211	NC

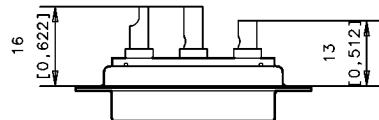
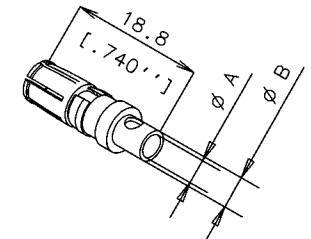

					TOL. GEN.		
					VOLUME PIECE		
					SURFACE PIECE		
C	conform to RoHS DM 05 23 010	Vallot	23/12 05		PROTECTION		C
B	RETAINING CLIP thermoplastic	QUERE	04/10 2004		TRAITEMENT	ECH. ENS.	
A	CREATION PLAN	Quere	19/10 95		MATIERE	N SERIE	
	IND. MODIFICATIONS	EXEC.	DATE	Approb			
	DATE DU TIRAGE			DESIGNATION			

Amphenol Socapex
Usine de Dole

HIGH POWER CONTACTS 0,5 Au