

This document is the property of Amphenol Corporation and is delivered on the express condition that it is not to be disclosed, reproduced or used, in whole or in part, for manufacture or sale by anyone other than Amphenol Corporation without its prior consent. It is not to be used to disclose or to use any information in this document.

REVISIONS				
SYM	ECN	DESCRIPTION	DATE	APPROVED
L	HK1406	Release to Customer	05/05/97	NELSON
M	HK3437	UPDATE DRAWING TO COMPLY WITH RoHS	07/18/05	IP

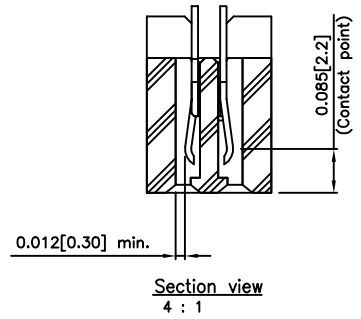

**CPK Options**

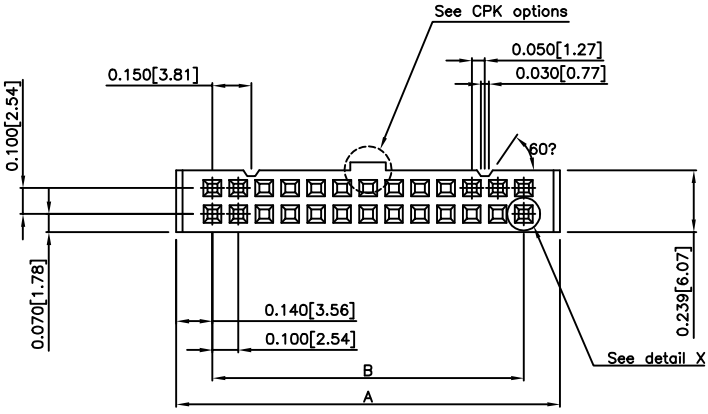
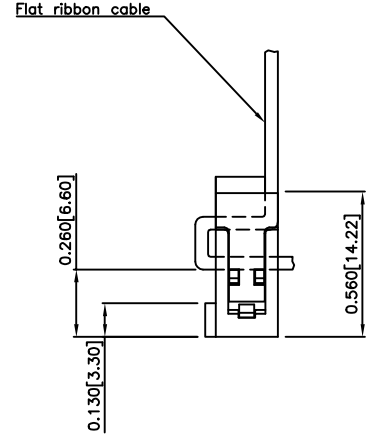
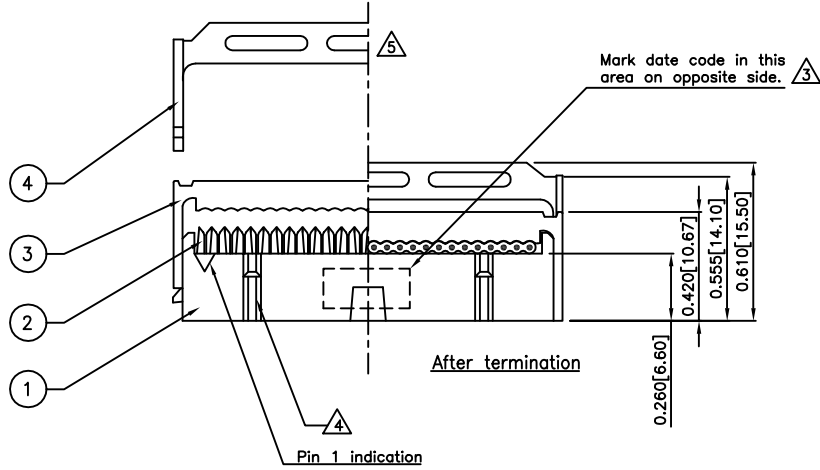
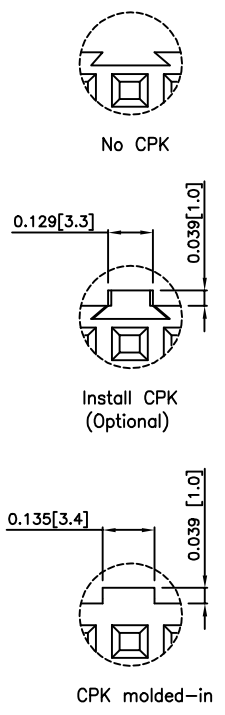

**Accessories**

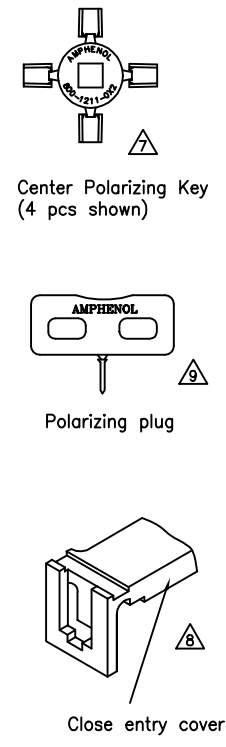

**Customer Drawing**

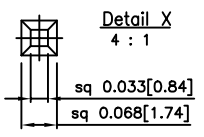

Note: Unit in inch [mm]

ITEM NO	PART OR IDENTIFICATION NO	NOMENCLATURE OR DESCRIPTION	QTY REQ'D
1	-	Insulator Body	1
2	-	Contact	XX
3	-	Cover	1
4	-	Strain Relief (optional)	(1)

UNLESS OTHERWISE SPECIFIED TOLERANCES		APPROVAL	DATE	TITLE
U.S.	METRIC	DRAWN	DATE	
.X +/- .020	0.51	ALEX.LEE	07/18/05	Amphenol
.XX +/- .010	0.25	CHECKED	TSUI	
.XXX +/- .005	0.13			
FRACTIONS +/-				
ANGLES +/-	2.5° 2.5°			
FOR MATERIALS AND FINISHES SEE NOTES		DRAWING FILE : \DRAWING\ 812\C812.dwg		812 Series Connector
REMOVE SHARP EDGES		ANGLE OF PROJECTION		
DIMENSIONS		SIZE		DRAWING NO.
U.S.	INCHES	A3		
METRIC	MM	SCALE		REV.
		2 : 1		M
		SHEET 1 OF 2		

This document is the property of Amphenol Corporation and is delivered on the express condition that it is not to be disclosed, reproduced or used, in whole or in part, for manufacture or sale by anyone other than Amphenol Corporation without its prior consent, & that no right is granted to disclose or to use any information in this document.

REVISIONS				
SYM	ECN	DESCRIPTION	DATE	APPROVED
		See sheet 1		

**Notes:**

- Connectors purchased under this drawing will mate with MIL-C-83503/20A and MIL-C-82503/21A header connectors with latches or without latches and 816 / 821 header connectors.
- This assembly is designed to meet requirements of MIL-C-83503/7B, and European standard IEC 603-13
- For P/N with prefix "E", date code are added on back side of socket.
- This polarization key slot not available on size 10 and 14.
- Strain relief may be ordered separately, Amphenol P/N 800-1206-XXX (see Table II)
- Strain relief is bagged separately.
- Center polarizing key (CPK) may be ordered separately, Amphenol P/N 800-1211-002 grey or 800-1211-012 black
- Optional closed entry cover (CEC) available. May be ordered separately. (see Table II on this sheet) assemblies ordered without standard cover and with CEC will have CEC's bagged separately.
- Polarizing plug may be ordered separately, Amphenol P/N 800-1211-004 15% GF Nylon white or 800-1211-005 30% GF PBT grey
- Termination kit P/N 357-116.
- This connector is both UL and CSA approved.
- Refer to Amphenol S-812-001 for product specification.
- Material should be fulfilled amphenol spec#SSN001.

**Part Number System**

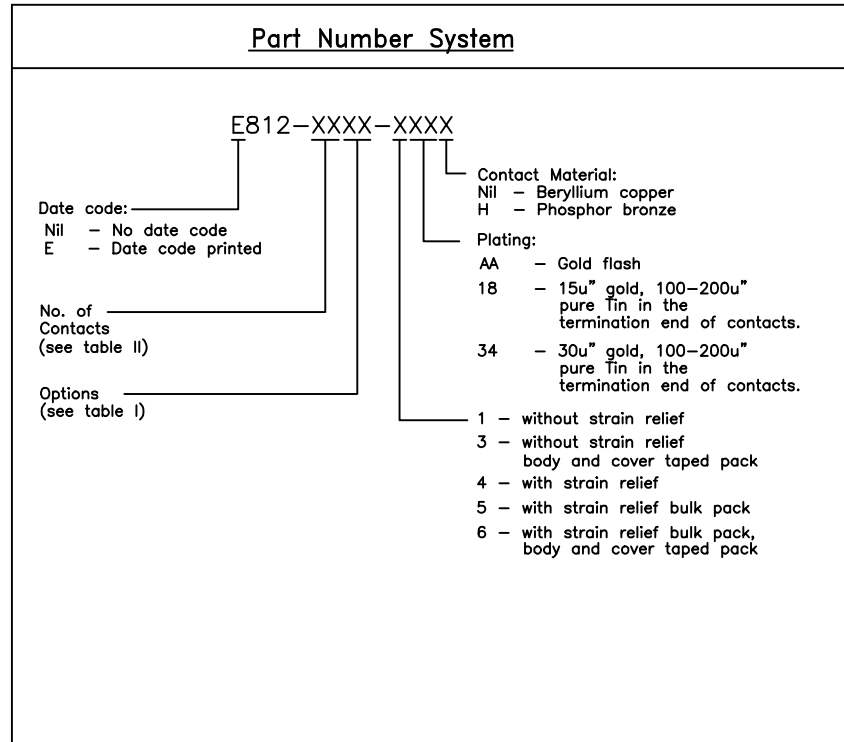

**Table I - Options**

- Standard product**
- 22 - Grey, no CPK
  - 33 - Grey, CPK molded-in
  - 34 - Grey, CPK molded-in, CEC even side
  - 35 - Grey, CPK molded-in, CEC odd side
  - 43 - Grey, no CPK, CEC odd side
  - 44 - Grey, no CPK, CEC even side
- Standard product with special requirement**
- 03 - Grey, no CPK, CEC bulk pack
  - 04 - Grey, CPK molded-in, CEC bulk pack  $\Delta$ 6
  - 12 - Grey, no CPK, cover bulk pack
  - 13 - Grey, CPK molded-in, cover bulk pack
  - 32 - Grey, CPK installed
  - 36 - Grey, CPK molded-in, CEC even side with slots
  - 37 - Grey, CPK molded-in, CEC odd side with slots
  - 38 - Grey, CPK molded-in, standard cover with slots
  - 42 - Grey, CPK Glued-in
- Non-standard product (specific quantity required)**
- 02 - Black, no CPK, non pre-latch
  - 05 - Black, no CPK, CEC bulk pack  $\Delta$ 6
  - 06 - Black, CPK molded-in, CEC bulb pack  $\Delta$ 6
  - 09 - Black, no CPK
  - 10 - Black, CPK molded-in
  - 23 - Black, no CPK
  - 45 - Black, CPK molded-in

**Table II**

No. of position	Strain Relief 800-1206-XXX		CEC 800-1205-XXX		A		B	
	Grey	Black	Grey	Black	in±.004	mm±.10	in±.005	mm±.13
10	-030	-050	-070	-090	.68	[17.27]	.40	[10.16]
14	-031	-051	-071	-091	.88	[22.35]	.60	[15.24]
16	-032	-052	-072	-092	.98	[24.89]	.70	[17.78]
20	-033	-053	-073	-093	1.18	[29.97]	.90	[22.86]
26	-034	-054	-074	-094	1.48	[37.59]	1.20	[30.48]
30	-040	-060	-080	-100	1.68	[42.67]	1.40	[35.56]
34	-035	-055	-075	-095	1.88	[47.75]	1.60	[40.64]
36	-041	-061	-081	-101	1.98	[50.29]	1.70	[43.18]
40	-036	-056	-076	-096	2.18	[55.37]	1.90	[48.26]
50	-037	-057	-077	-097	2.68	[68.07]	2.40	[60.96]
60	-038	-058	-078	-098	3.18	[80.77]	2.90	[73.66]
64	-039	-059	-079	-099	3.38	[85.85]	3.10	[78.74]

**Customer Drawing**



UNLESS OTHERWISE SPECIFIED <b>TOLERANCES</b> U.S. METRIC .X +/- .020 0.51 .XX +/- .010 0.25 .XXX +/- .005 0.13 FRACTIONS +/- ANGLES +/- 2.5' 2.5'	<b>APPROVAL</b> DRAWN ALEX.LEE CHECKED TSUI CHECKED	<b>DATE</b> 07/18/05 07/18/05	<b>Amphenol</b>  <b>812 Series Connector</b>  TITLE 812 Series Connector	
	DRAWING FILE : \DRAWING\812\C812.dwg			SIZE DRAWING NO. <b>A3 C812-XXXX-XXX</b>
	REMOVE SHARP EDGES DIMENSIONS U.S. INCHES METRIC MM			
	ANGLE OF PROJECTION 			SCALE 2 : 1 SHEET 2 OF 2