

Amphenol

Now you're connected

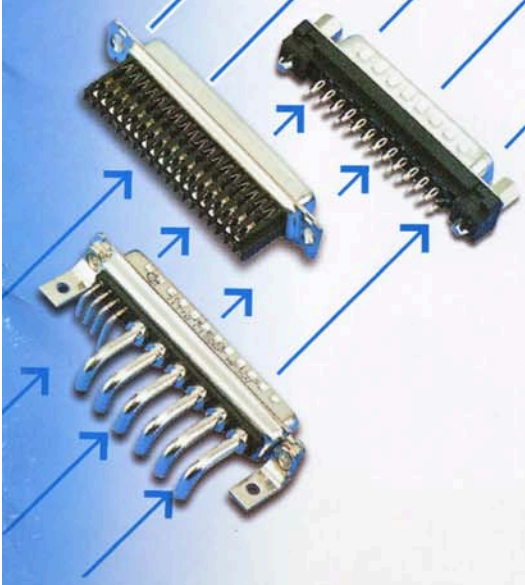

D-Sub Hardware



D-SUBMINIATURE HARDWARE

Female Screw Lock Assemblies

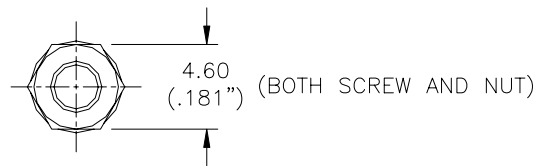
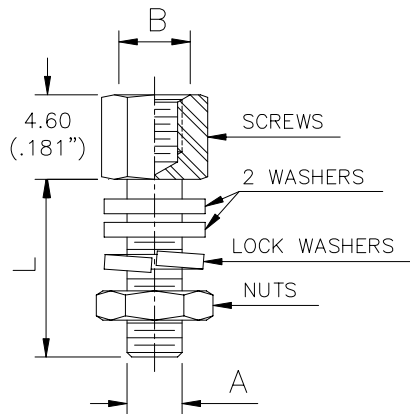

Screwlock/nut:
Washer:
Lock washer:

Steel, tin plated
Steel, tin plated
XC 35, tin plated

P/N	Quantity	Packaging	Plating	A	B	L
L17D20418 2 X	10 Screws	Bag	Tin	4-40	4-40	8.3mm (.327")
L17D20418 2M3 X	10 Screws	Bag	Tin	M3	4-40	8.3mm (.327")
L17D20418 33 X	10 Screws	Bag	Tin	M3	4-40	8.5mm (.335")
L17D20418 M3 X	10 Screws	Bag	Tin	M3	M3	8.3mm (.327")
L17D20418 2L X	10 Screws	Bag	Tin	4-40	4-40	13mm (.511")
L17D20418 2LM3 X	10 Screws	Bag	Tin	M3	4-40	13mm (.511")
L17D20418 2SM3 X	10 Screws	Bag	Tin	M3	4-40	15.8mm (.622")
L17D20418 39 X	10 Screws	Bag	Tin	4-40	4-40	15.8mm (.622")
L17D20418 2T X	10 Screws	Bag	Tin	4-40	4-40	8.3mm (.327")
L17D20418 43 X	10 Screws	Bag	Tin	M3	4-40	8.5mm (.311")

Screw lock assemblies are sold in bags of ten sets. 2 sets are required per connector

D-SUBMINIATURE HARDWARE

Metal Dust Cover



Material: Steel
 Plating: Tin plated

Description	Shell Size	Number of Contacts		Cover for Socket Connector	Cover for Plug Connector
		Standard Density	High Density		
Metal Dust Cover, Without Chain	E	9	15	L17D 4K 63010	L17D 4K 63110
	A	15	26	L17D 4K 63016	L17D 4K 63116
	B	25	44	L17D 4K 63026	L17D 4K 63126
	C	37	62	L17D 4K 63038	L17D 4K 63138
	D	50	78	L17D 4K 63051	L17D 4K 63151
Metal Dust Cover, With Chain	E	9	15	L17D 4K 63009	L17D 4K 63109
	A	15	26	L17D 4K 63015	L17D 4K 63115
	B	25	44	L17D 4K 63025	L17D 4K 63125
	C	37	62	L17D 4K 63037	L17D 4K 63137
	D	50	78	L17D 4K 63050	L17D 4K 63150

D-SUBMINIATURE HARDWARE

Slide Lock Assemblies

Plate Material: Steel, tin plated
 Mounting Screws: Steel, tin plated
 (Bag contains 1 plate, 2 mounting screws, 2 nuts, 4 washers and 2 locking washers)

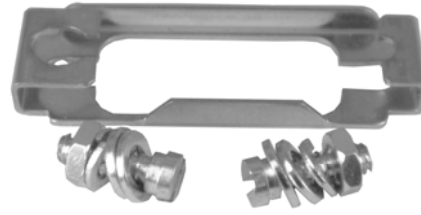

Locking Post Assembly

P.N. L17D 53018 X (10/bag)

Post Screw: Steel, tin plated
 (Bag contains 10 mounting screws, 10 nuts, 20 washers and 10 locking washers)

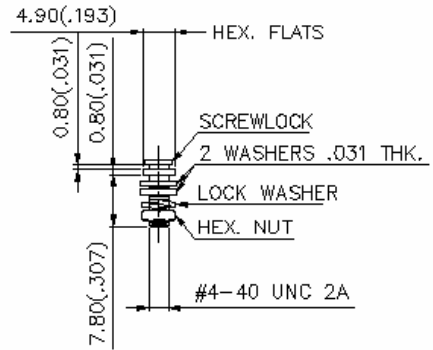
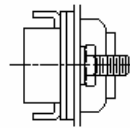
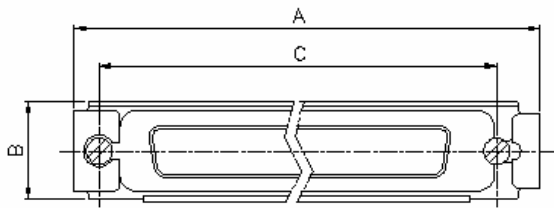

Slide lock and locking post assemblies sold separately

Shell Size	Part No.	A	B	C
E	L17D 51224 1	35mm (1.378")	12.6mm (.496")	27.4mm (1.079")
A	L17D 51220 1	43.3mm (1.705")	12.6mm (.496")	35.7mm (1.406")
B	L17D 51221 1	57.5mm (2.264")	12.6mm (.496")	49.47mm (1.948")
C	L17D 51222 1	74.2mm (2.921")	12.6mm (.496")	65.9mm (2.594")
D	L17D 51223 1	71.5mm (2.815")	15.1mm (.594")	63.5mm (2.500")

D-SUBMINIATURE HARDWARE

Male Screw Lock Assembly

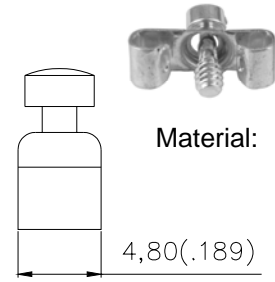
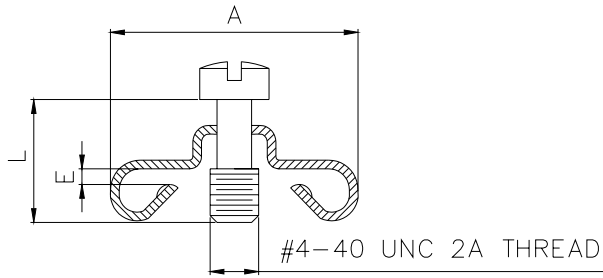

Material:



Steel, tin plated

Part No. E, A, B C Shell	A	L	E
L17D 20419 21 X	14.3mm (.563")	7.1mm (.280")	1.4mm (.055")
L17D 20419 18 X	14.3mm (.563")	7.1mm (.280")	1.0mm (.039")
L17D 20419 16 X	14.3mm (.563")	7.1mm (.280")	1.2mm (.047")
L17D 20419 X	14.3mm (.563")	7.1mm (.280")	0.8mm (.031")
D Shell			
L17D 20420 12 X	16.9mm (.665")	7.1mm (.280")	1.4mm (.055")
L17D 20420 13 X	16.9mm (.665")	7.1mm (.280")	1.0mm (.039")
L17D 20420 15 X	16.9mm (.665")	7.1mm (.280")	1.2mm (.047")
L17D 20420 X	16.9mm (.665")	7.1mm (.280")	0.8mm (.031")

Spring Latch

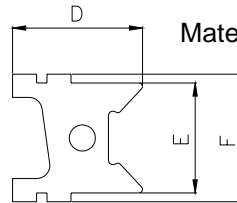
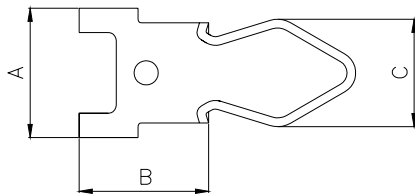

Material:

Steel, tin plated

Size	Part No.	A	B	C	D	E	F
E, A, B, C	L17 529	14.8mm (.583")	15.6mm (.614")	12.3mm (.484")	14.9mm (.587")	12.6mm (.496")	14.6mm (.575")

Amphenol

connecting people
in the new millenium



Amphenol Corporation is one of the world's leading producers of electronic and fiber optic connectors, cable and interconnect systems. The primary end markets for the Company's products are communication systems for the converging technologies of voice, video and data communications, including wired and wireless internet, broadband networks, industrial, automotive and aerospace applications.

With more than **55 manufacturing and assembly operations on 5 continents** and sales, marketing and distribution organizations in more than **55 countries**, Amphenol has developed a strategy of local operations which allow proximity to market and reactivity. This worldwide globalization allows permanent cost reduction programs and continuous investments to meet customer expectations, as well as engineering talents around the world to design for local needs.

Our company, characterized by speed and flexibility, provides and develops new solutions for infra-structure, enterprise networks, handset and internet appliances.

Amphenol

Amphenol IT & Communication Products

Amphenol Shenzhen Sales Office
Shenzhen, China
Tel: +86-755-8368-3575
Fax: +86-755-8368-3567
Email: info@amphenol.com.cn

Amphenol InfoCom Europe
Houten, Netherlands
Tel: +31-30-635-8000
Fax: +31-30-637-7034
Email: info@amphenol-nl.com

Amphenol East Asia Limited
Hong Kong, China
Tel: +852-2699-2663
Fax: +852-2688-0974
Email: info@amphenol.com.hk

Amphenol Canada Corp.
Ontario, Canada
Tel: +1-416-291-4401
Fax: +1-416-292-0647
Email: sales@amphenolcanada.com

Amphenol China Sales Offices
Beijing
Tel: +86-10-6468-4019
Fax: +86-10-6468-4020

Amphenol Dae Shin Limited
Bucheon, Korea
Tel: +82-32-610-3800
Fax: +82-32-673-2507
Email: info@amphenol.co.kr
Web: www.amphenol.co.kr

Amphenol Taiwan Corporation
Taoyuan, Taiwan
Tel: +886-3-264-7200
Fax: +886-3-327-5296
Email: info@amphenol.com.tw

Amphenol South East Asia
The Concourse, Singapore
Tel: +65-6294-2128
Fax: +65-6294-3522
Email: info@amphenol.com.sg

Xi'an
Tel/Fax: +86-29-8781-3718
Email: info@amphenol.com.cn

Amphenol Shanghai Sales Office
Shanghai China
Tel: +86-21-6267-5566
Fax: +86-21-6272-7587
Email: info@amphenol.com.cn

Amphenol Commercial Products, Americas
Milpitas, CA, USA
Tel: +1-408-546-0397
Fax: +1-408-546-0399
Email: info@amphenolacp.com

Do not hesitate to contact us for further information

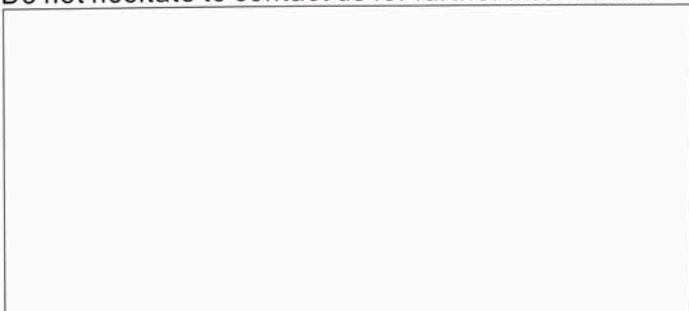

Factory Address:
Block A3/A4, The 4th Industrial District of
Industrial Headquarters, Dong Keng Road
Gong Ming Town, Shen Zhen China
Fax: +86(0)755 2754 9955

Technical Support
Tel: +86(0)755 2717 7945
Info-dsub@amphenol.com.cn
www.dsubconnector.com