

Amphenol MIL-DTL-38999, Series III, TV



**New
Featured**



Other New 38999

Dualok™ see page 55 HD38999 see page 46



TABLE OF CONTENTS

Combined MIL-DTL-38999 Series I, II, III

- Shell Size & Insert Arrangements Availability 6-9
- Insert Arrangement Drawings 10-17
- Specifications - Contact Ratings, Service Ratings, Finish Data 18, 19

MIL-DTL-38999, Series III TV

- Performance, Options 21, 22
- Weight Comparison (Composite vs. Metal) 23
- Test Data 24
- How to Order (Commercial & Military) 25-27
- How to Order (Boeing BACC63) 28

Shell Styles:

- Crimp Wall Mounting Receptacle TVP00R (D38999/20) /CTVP00R (D38999/20) 29
- Crimp Box Mounting Receptacle TVP02R / CTVP02R 30
- Crimp Straight Plug TV06R (D38999/26) / CTV06R (D38999/26) 31
- Crimp CLUTCH-LOK™ Straight Plug for High Vibration TV26/MTV26 32
- Crimp Jam Nut Receptacle TV07R (D38999/24) / CTV07R (D38999/24) 33
- Crimp Line Receptacle TV01R / CTV01R 34
- Crimp Flange Mounting Plug TV09R 35
- Hermetic Box Mounting Receptacle TVPS02Y (D38999/21) 36
- Hermetic Jam Nut Receptacle TVS07Y (D38999/23) 37
- Hermetic Solder Mounting Receptacle TVSIY (D38999/25),
Hermetic Weld Mounting Receptacle TVSHIY (D38999/27) 38
- Breakaway Fail-Safe Lanyard Release Plug
D38999/29 & /30 (88-5565 / 91-5565) 39, 40
- Breakaway Fail-Safe How to Order (Military/Commercial) 41, 42
- Breakaway MIL-STD-1760 Lanyard Release Plug D38999/31 43
- Breakaway MIL-STD-1760 How to Order (Military) 44
- Breakaway Hybrid, Low Profile Lanyard Release Plug 45
- Stores Management Type II, Rail Launch (MIL-STD-1760) 45



MIL-DTL-38999 Series III Typical Markets:

- Military & Commercial Aviation
- Military Vehicles
- Missiles & Ordnance
- C4ISR
- Space Applications

Amphenol
Aerospace

MIL-DTL-38999, Series I LJT, II JT, III TV, HD

Insert Availability and Identification Chart



Series	Series	Series	Military	MIL-DTL-27599 JT/LJT Solder	Crimp	Hermetics			Service Rating	Total Contacts	Contact Size											
JT II	LJT I	TV III	III			Class H	Class Y	TV*			23 HD	22D	22M	22	20	16	12	12 (Coax)	10 (Power)	8 (Coax)	8†† (Twinax)	
14-15				X	X	P	P		I	15					14	1						
	15-15	15-15	D15	X	X	P/S	P/S	P	I	15					14	1						
14-18				X	X	P/S	P/S															
	15-18	15-18	D18	X	X	P/S	P/S	P	I	18					18							
14-19■				X	X																	
	15-19	15-19	D19		X	P	P	P	I	19					19							
14-35					X	P	P															
	15-35	15-35	D35		X	P/S	P/S	P	M	37		37										
14-37				X	X	P	P		M	37			37									
	15-37			X	X	P	P		M	37												
		15-55■							N	55	55											
14-68■					2	P	P															
	15-68■			X	3				1	8						8						
14-97■					X	P	P															
	15-97	15-97	D97	X	X	P	P	P	I	12					8	4						
	17-2	17-2	E2		X	◆			M	39		38										1
16-6					X	P	P															
	17-6	17-6	E6		X	P	P	P	I	6							6					
16-8				X	X	P	P															
	17-8★	17-8★	E8	X	X	P/S	P/S	P	II	8					8							
16-13■					2																	
	17-13■				2				I	13						13						
	17-22■	17-22★■			◆				Coax	4							2		2			
	17-25■				2				M	24		22								2		
16-26				X	X	P/S	P/S															
	17-26	17-26	E26	X	X	P/S	P/S	P	I	26					26							
16-35					X	P	P															
	17-35	17-35	E35	X	X	P	P	P	M	55		55										
16-42					X																	
	17-42■				P				M	42				42								
		17-52■			X	◆			M	2												2
16-55				X	X	P/S	P/S															
	17-55			X	X	P/S	P/S		M	55			55									
		17-60■			X				I/Coax	10		8								2		
		17-73■							N	73	73											
16-99				X	X	P	P															
	17-99	17-99	E99	X	X	P	P		I	23					21	2						
		19-AD■			X	◆			Inst.	17					16							1
18-11				X	X	P	P															
	19-11★	19-11★	F11	X	X	P	P	P	II	11						11						
	19-18	19-18	F18		2	2			M	18		14										4
18-28				X	X																	
	19-28■	19-28	F28	X	P	X			I	28					26	2						
18-30				X	X																	
	19-30■			X	P				I	30						29	1					
		19-31■			X				M	15		12					1			2		
18-32				X	X	P/S	P/S															
	19-32	19-32	F32	X	X	P/S	P/S	P	I	32					32							
18-35					X	P	P															
	19-35	19-35	F35		X	P	P	P	M	66		66										
18-53				X	X																	
	19-53■				P				M	53				53								
18-66				X	X	P	P															
	19-66				X	P	P		M	66			66									
	19-67■			X	3	S	S		M	67			67									
18-68■					2																	
	19-68■	19-68			3	S			I	18						18						
18-96■					2																	
		19-88■							N	88	88											
20-1					X	P	P															
	21-1				X	P/S	P/S		M	79				79								

38999

- III
- HD
- Dualok
- II
- I
- SJT
- Accessories
- Aquacon
- Herm/Seal
- PCB

- HIGH SPEED
- Fiber Optics
- Contacts Connectors Cables

EMI Filter
Transient

26482
Matrix 2

83723 III
Matrix | Pyle

26500
Pyle

5015
Crimp Rear Release Matrix

22992
Class 1

Back-Shell's

Options
Others

- 38999
- III
- HD
- Dualok
- II
- I
- SJT
- Accessories
- Aquacon
- Herm/Seal
- PCB
- HIGH SPEED
- Fiber Optics
- Contacts Connectors Cables
- EMI Filter Transient
- 26482 Matrix 2
- 83723 III Matrix | Pyle
- 26500 Pyle
- 5015 Crimp Rear Release Matrix
- 22992 Class I
- Back-Shells
- Options Others

Series	Series	Series	Military	MIL-DTL-27599 JT/LJT Solder	Crimp	Hermetics			Service Rating	Total Contacts	Contact Size											
						H	Y	TV*			23 HD	22D	22M	22	20	16	12	12 (Coax)	10 (Power)	8 (Coax)	8†† (Twinax)	
20-2					X				M	65												
	21-2■				X																	
20-11■					3				I	11												
	21-11★	21-11★	G11		X																	
20-16					X	X	P/S	P/S														
	21-16★	21-16★	G16	X	X	P	P	P		II	16											16
	21-25■									I	25											25
	21-27■			X						I	27											27
		21-29■			X					I	27											19 4 4
20-35					X	P	P															
	21-35	21-35	G35		X	P/S	P/S	P		M	79		79									
20-39				X	X	P	P															
	21-39	21-39	G39	X	X	P	P	P		I	39											37 2
20-41				X	X	P	P															
	21-41	21-41	G41	X	X	P/S	P/S	P		I	41											41
	21-75★	21-75★◇	G75		2	X			N	M	4											4 (4)
	21-79■	21-79■			2	X				II	19		17									2 (5)
		21-121■								N	121	121										
22-1					X	P/S	P/S															
	23-1				X	P	P			M	100			100								
22-2				X	X	P	P															
	23-2			X	X	P	P			M	85				85							
	23-6★■	23-6★■			P					M	6											6
22-14■					2	◇																
	23-14■	23-14■			2	◇				I	14											14
22-21				X	X	P	P															
	23-21★	23-21★	H21	X	X	P	P	P		II	21											21
22-32				X	X	P	P															
	23-32■			X	P					I	32											32
	23-34■			X						I	34											34
22-35					X	P/S	P/S															
	23-35	23-35	H35		X	P	P	P		M	100		100									
22-53■					P																	
	23-53	23-53	H53	X	X	P/S	P/S	P		I	53											53
		23-54■			X					M	53		40									9 4
22-55				X	X	P	P															
	23-55	23-55	H55		X			P		I	55											55
	23-97■			X						II	16											16
	23-99■			X						II	11											11
		23-151■								N	151	151										
24-1					X	P	P															
	25-1				X	P	P			M	128			128								
24-2					X																	
	25-2				X					M	100				100							
24-4					X	P	P															
	25-4	25-4	J4		X			P		I	56											48 8
	25-7■	25-7	J7		X				M	Twinax	99		97									2
		25-8★	J8		◇					Twinax	8											8
		25-11***	J11		2	◇				N	11											2
		25-17■			◇					M	42		36									9
24-19■					X	P	P															
	25-19★	25-19★	J19		X			P		I	19											19
	25-20■	25-20***	J20		2	◇				N	30											10 13 4

- X Completely tooled.
- Majority of tooling is completed (contact Amphenol Aerospace for availability).
- ◇ Not tooled for 02-R.
- P Available with Pin contacts only
- S Available with Socket contacts only
- P/S Available with Pin contacts or Socket contacts
- ★ Ground plane proprietary option available. Arrg. 9-5, 26-62 is exclusively ground plane type.
- Not Mil-Qualified.
- ◇ 21-75 is Mil-Qualified with twinax contacts only.
- * Hermetic inserts - solder termination standard. (Contact Amphenol Aerospace for optional PCB or eyelet termination).
- HD designates High Density 38999 Series III insert patterns which use size 23 contacts only. Not rated over 175°C.
- ** Two size 16 contacts dedicated to fiber optics. See the Fiber Optic Section for more information.
- *** For use in MIL-STD-1760 applications (see pages 43 & 44).
- † For RG 180/U and RG 195/U cables only.
- †† Size 8 Coax and Twinax are interchangeable.
- (2) Not Tooled for RP or 02RE
- (3) Pin inserts only, not tooled for RP or 02RE (Consult Amphenol for avail.)
- (4) MS connector 21-75 is supplied with size 8 twinax. Commercial connector 21-75 is supplied with size 8 coax.
- (5) MS Connector 21-79 has provision for two size 8 coax contacts. Coax contacts are not supplied unless specified by customer.

MIL-DTL-38999, Series I LJT, II JT, III TV, HD

Insert Availability and Identification Chart

Series	Series	Series	Military	MIL-DTL-27599	Hermetics				Contact Size													
JT II	LJT I	TV III	III	JT/LJT Solder	Crimp	H	Y	TV*	Service Rating	Total Contacts	23 HD	22D	22M	22	20	16	12	12 (Coax)	10 (Power)	8 (Coax)	8†† (Twinax)	8 Quadrax
24-24					X	P	P		I	24						12	12					
	25-24★	25-24★	J24		X	P	P		I	25					16	5				4		
		25-26■★			◆				I	29												
24-29					X				I	29												
	25-29★	25-29★	J29	X	X				I	29												
24-35					X	P	P		New													
	25-35	25-35	J35		X	P	P	P	M	128		128										
24-37					X				I	37												
	25-37★	25-37★	J37		X				I	37												
24-43■					3				I	43						23	20					
	25-43	25-43	J43	X	2	◆			I	43												
	25-46	25-46	J46		2	◆			I	46						40	4			2		
24-61					X		P	P	I	61						61						
	25-61	25-61	J61	X	X	P	P	P	I	61												
		25-62■★			X	◆			I	12						8						4
		25-90			◆				I	46						40	4				2	
		25-187■							N	187	187											
		25-F4■			X				M/I	66		49				13	4					

- HD designates High Density 38999 Series III insert patterns which use size 23 contacts only. Not rated over 175°C
- X Completely tooled.
- ◆ Not tooled for 02-R.
- P Pin inserts only (contact Amphenol Aerospace for socket availability).
- ★ Ground plane proprietary option available. Arrg. 9-5, 25-62 is exclusively ground plane type.
- Not Mil-Qualified.

TV Series III

Select Shell Size - Special Insert Arrangement

(Not Mil-Spec Qualified)

Shell Size-Insert Arrg.	Crimp	Hermetics*	Service Rating	Total Contacts	Comments	Contact Size			
						22D	20	16	12
9-2	X		I	2	Formerly Pyle		2		
15-4	X		II	4	Formerly Pyle			4	
15-25	X		M	25	Formerly Pyle	22		3	
17-20	X		M	20	Formerly Pyle		16	4	
21-12	X		I	12	Formerly Pyle		3		9
21-21	X		M/Inst.	41	Improved sealing	32			9
21-99	X		M	16	Formerly Pyle	5			11
25-92	X		M	101	Formerly Pyle	92		9	
25-97	X		M	42	Formerly Pyle	26		3	13

Select Non-Standard Shell Size

- Special Insert Arrangement

Shell Size-Insert Arrg.	Crimp	Hermetics*	Service Rating	Total Contacts	Contact Size				
					22D	20	8	4	0
25-16	X		M	8		6		2	
25L-3	X		II	3			1	2	
25L-7	X		II	7			7		
33-3	X		II	3				1	2
33-5	X		II	5				5	
33-6	X		II	6			2	4	
37-5	X		II	4					4

(Insert arrangements requiring non-standard shells or larger contacts)

- X Completely tooled.
- Majority of tooling is completed (contact Amphenol Aerospace for availability).
- ◆ Not tooled for 02-R.
- P Pin inserts only (contact Amphenol Aerospace for socket availability).
- ★ Ground plane proprietary option available. Arrangement 9-5, 25-62 is exclusively ground plane type.
- Not Mil-Qualified.
- * Hermetic inserts - solder termination standard. (Contact Amphenol Aerospace for optional PCB or eyelet termination).
- ** Two size 16 contacts dedicated to fiber optics. See the Fiber Optic section for more information.
- *** For use in MIL-STD-1760 applications (pgs. 43 & 44).
- † For RG 180/U and RG 195/U cables only.
- †† Size 8 Coax and Twinax are interchangeable. Note: 25L-3 and 25L-7 require longer shells.

38999

- III
- HD
- Dualok
- II
- I
- SJT
- Accessories
- Aquacon
- Herm/Seal
- PCB

HIGH SPEED

Fiber Optics

Contacts
Connectors
Cables

EMI Filter
Transient

26482
Matrix 2

83723 III
Matrix | Pyle

26500
Pyle

5015
Crimp Rear
Release
Matrix

22992
Class 1

Back-
Shells

Options
Others

Front face of pin inserts illustrated

38999

- III
- HD
- Dualok
- II
- I
- SJT
- Accessories
- Aquacon
- Herm/Seal
- PCB

Shell Size & Insert Arrg. for:



Series II JT	8-2		8-3		8-6			8-35		8-44		8-97		8-98	
Series I LJT	9-3		9-6		9-7		9-22		9-35		9-44		9-98		
Series III TV	7-D2	7-D3	7-D4		9-5			9-9 HD		9-35		9-94		9-98	
Service Rating	M	M	M	M	M	Grounded	M	M	N	I	M	M	M	M	I
Number of Contacts	2	3	4	2	3	1	6	7	9	2	6	4	2	2	3
Contact Size	22D	22D	22D	20	20	8 Twinax	22M	22M	23	20	22D	22	20	22M	20

- HIGH SPEED
- Fiber Optics
- Contacts
- Connectors
- Cables

Shell Size & Insert Arrg. for:

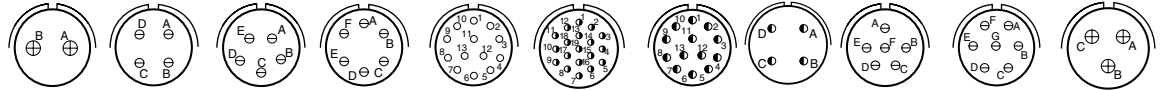

Series II JT	10-4		10-5		10-13			10-35		10-98		10-99		12-3		
Series I LJT	11-2		11-4		11-5		11-6		11-13		11-35		11-98		11-99	
Series III TV	11-2		11-4		11-5		11-19 HD			11-35		11-54		11-98		
Service Rating	I	I	I	I	I	M	N	M	II	I	I	I	I	II		
Number of Contacts	2	4	5	6	13	19	13	4	6	7	3	16				
Contact Size	16	20	20	20	22M	23	22D	22D	20	20	16					

- EMI Filter
- Transient

Shell Size & Insert Arrg. for:

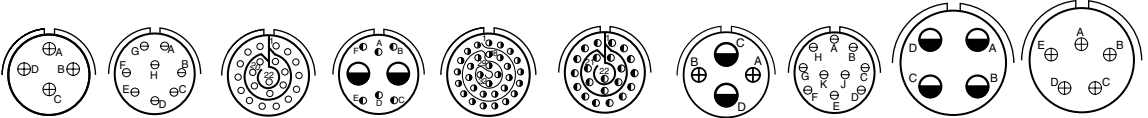

Series II JT	12-4		12-8		12-22			12-35		12-98		14-4		14-5	
Series I LJT	13-4		13-8		13-22			13-35		13-98		15-4		15-5	
Series III TV	13-4		13-8		13-26			13-32 HD		13-35		13-63		13-98	
Service Rating	I	I	M	M	N	M	I	I	I	II					
Number of Contacts	4	8	22	6	2	32	22	2	2	10	4	5			
Contact Size	16	20	22M	22D	12	23	22D	16	12	20	12	16			

- 26482
- Matrix 2

Shell Size & Insert Arrg. for:

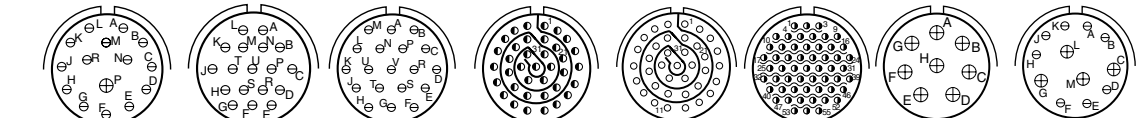

Series II JT	14-15		14-18		14-19			14-35		14-37		14-68		14-97	
Series I LJT	15-15		15-18		15-19			15-35		15-37		15-68		15-97	
Series III TV	15-15		15-18		15-19			15-35		15-55 HD		15-97			
Service Rating	I		I	I	I	M	M	N	I	I	I				
Number of Contacts	14	1	18	19	37	37	55	8	8	4					
Contact Size	20	16	20	20	22D	22M	23	16	20	16					

- 5015
- Crimp Rear Release
- Matrix

Shell Size & Insert Arrg. for:

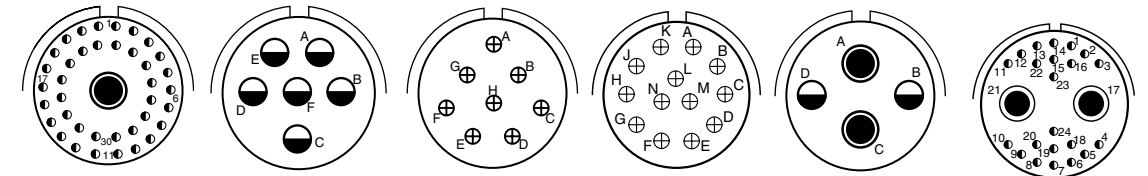

Series II JT	16-6		16-8			16-13			17-22		17-25	
Series I LJT	17-2		17-6			17-8			17-13		17-22	
Series III TV	17-2		17-6			17-8			17-22		17-25	
Service Rating	M		I	II	I	Coax		M				
Number of Contacts	38	1	6	8	13	2	2	22	2			
Contact Size	22D	8 Twinax	12	16	16	12 Coax	8 Coax	22D	8 Coax			

- 22992
- Class I

- Back-Shells
- Options
- Others



HD: High Density HD38999 (use size 23 contacts only)

CONTACT LEGEND 8 10 12 16 20 22 22M 22D 23

MIL-DTL-38999, Series I LJT, II JT, III TV, HD Insert Arrangements



Front face of pin inserts illustrated

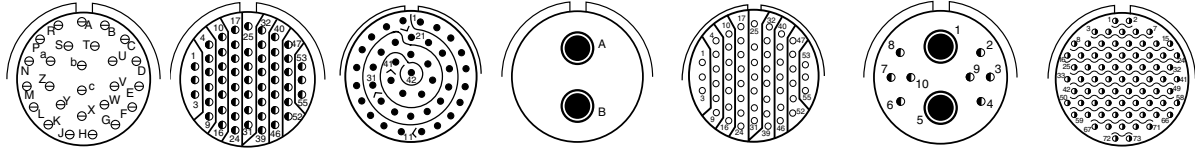

Shell Size & Insert Arrg. for:

Series I LJT	16-26	16-35	16-42	16-55		
Series II JT	17-26	17-35	17-42	17-55		
Series III TV	17-26	17-35		17-52	17-60	17-73 HD
Service Rating	I	M	M	M	M	I/Coax N
Number of Contacts	26	55	42	2	55	8 2 73
Contact Size	20	22D	22	8 Twinax	22M	22D 8 Coax 23

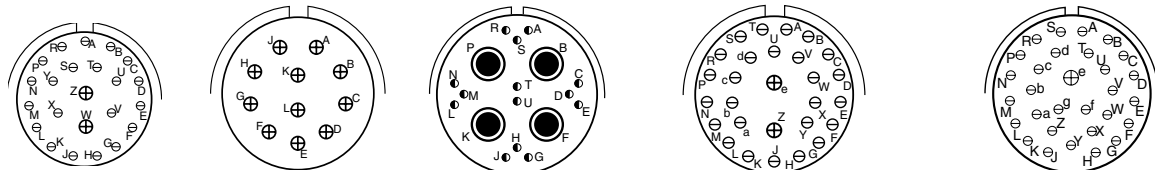

Shell Size & Insert Arrg. for:

Series II JT	16-99	18-11		18-28	18-30
Series I LJT	17-99	19-11	19-18	19-28	19-30
Series III TV	17-99	19-11	19-18	18-28	
Service Rating	I	II	M	M	I
Number of Contacts	21 2	11	14 4	26 2	29 1
Contact Size	20 16	16	22D 8 Twinax	20 16	20 16

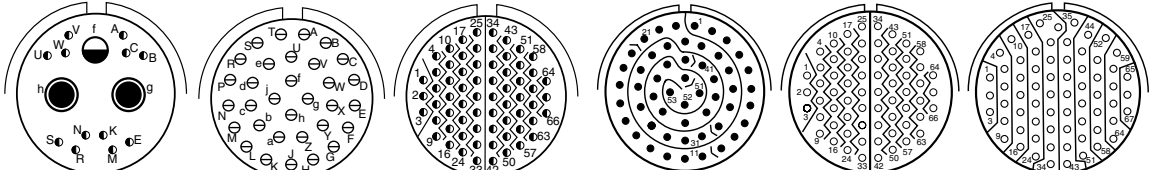

Shell Size & Insert Arrg. for:

Series II JT	18-32	18-35	18-53	18-66	
Series I LJT	19-32	19-35	19-53	19-66	19-67
Series III TV	19-31	19-32	19-35		
Service Rating	M	1	M	M	M
Number of Contacts	2 1 12	32	66	53	66 67
Contact Size	8 Coax 12 22D	20	22D	22	22M 22M

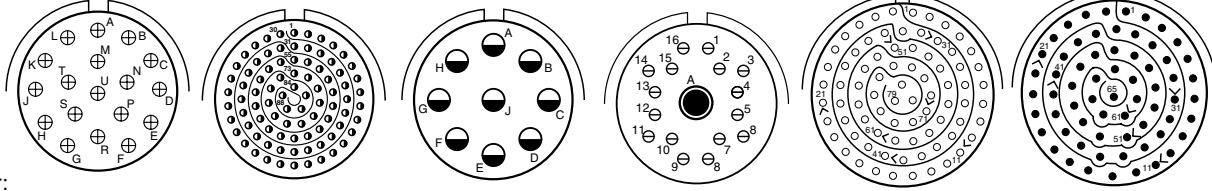

Shell Size & Insert Arrg. for:

Series II JT	18-68	18-96		20-1	20-2
Series I LJT	19-68			21-1	21-2
Series III TV		19-88 HD		19-AD	
Service Rating	I	N	I	Inst.	M II
Number of Contacts	18	88	9	16 1	79 65
Contact Size	16	23	12	20 8 Twinax	22M 22

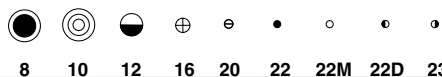

CONTACT LEGEND

HD: High Density HD38999 (use size 23 contacts only)

- 38999
- III
- HD
- Dualoc
- II
- I
- SJT
- Accessories
- Aquacon
- Herm/Seal
- PCB

- HIGH SPEED
- Fiber Optics
- Contacts
- Connectors
- Cables

- EMI Filter
- Transient

- 26482
- Matrix 2

- 83723 III
- Matrix | Pyle

- 26500
- Pyle

- 5015
- Crimp Rear Release Matrix

- 22992
- Class 1

- Back-Shells

- Options
- Others

38999

Front face of pin inserts illustrated

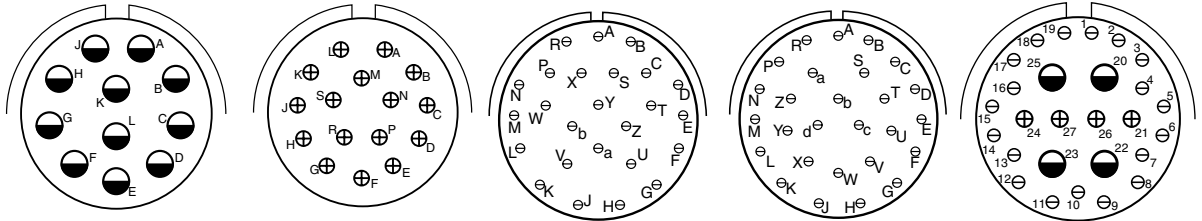

Shell Size & Insert Arrg. for:

Series II JT	20-11	20-16			
Series I LJT	21-11	21-16	21-25	21-27	
Series III TV	21-11	21-16			21-29
Service Rating	I	II	I	I	I
Number of Contacts	11	16	25	27	19 4 4
Contact Size	12	16	20	20	20 16 12

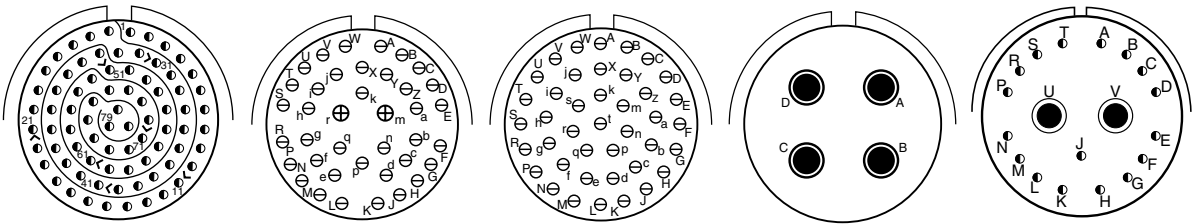

Shell Size & Insert Arrg. for:

Series II JT	20-35	20-39	20-41		
Series I LJT	21-35	21-39	21-41	21-75	21-79
Series III TV	21-35	21-39	21-41	21-75	21-79
Service Rating	M	I	I	N	II
Number of Contacts	79	37 2	41	4	17 (See Note)
Contact Size	22D	20 16	20	(See Note)	22D

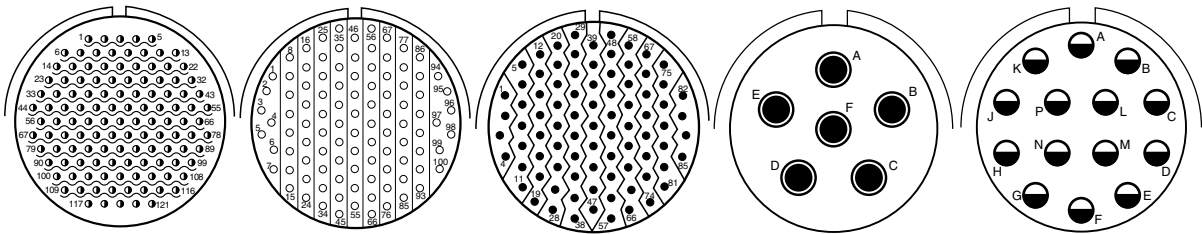

Shell Size & Insert Arrg. for:

Series II JT	22-1	22-2		22-14
Series I LJT	23-1	23-2	23-6	23-14
Series III TV	21-121 HD		23-6	
Service Rating	N	M	M	I
Number of Contacts	121	100	6	14
Contact Size	23	22M	8 Twinax	12

HD: High Density HD38999 (use size 23 contacts only)

Note: MS connector 21-75 is supplied with four size 8 twinax contacts. Commercial connector 21-75 is supplied with four size 8 coax contacts. MS connector 21-79 has provision for two size 8 coax contacts. Coax contacts are not supplied unless specified by customers.

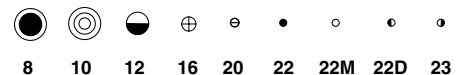

CONTACT LEGEND

Front face of pin inserts illustrated



Shell Size & Insert Arrg. for:

Series II JT	22-21	22-32	22-35
Series I LJT	23-21	23-32	23-34
Series III TV	23-21		23-35
Service Rating	II	I	M
Number of Contacts	21	32	100
Contact Size	16	20	22D

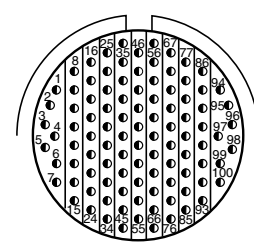
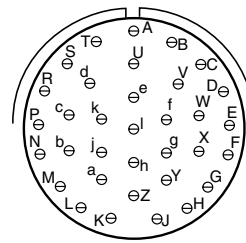
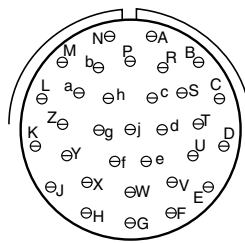

Shell Size & Insert Arrg. for:

Series II JT	22-53	22-55	22-55	23-97
Series I LJT	23-53	23-55		
Series III TV	23-53	23-54	23-55	
Service Rating	I	M	I	II
Number of Contacts	53	40 9 4	55	16
Contact Size	20	22D 16 12	20	16

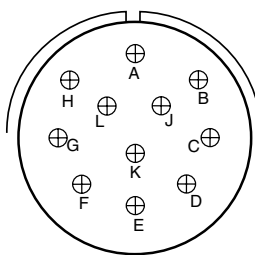
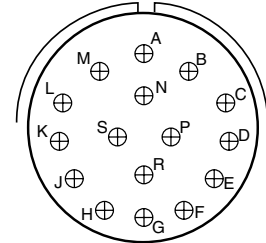
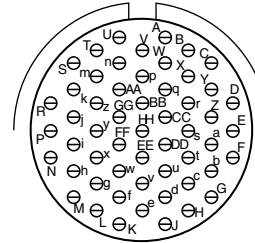
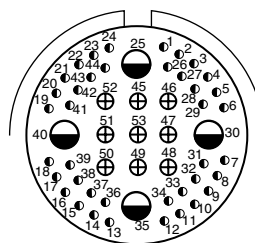

Shell Size & Insert Arrg. for:

Series II JT	23-99	23-151 HD	24-1	24-2
Series I LJT			25-1	25-2
Series III TV				
Service Rating	II	N	M	M
Number of Contacts	11	151	128	100
Contact Size	16	23	22M	22

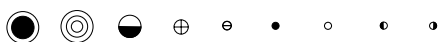
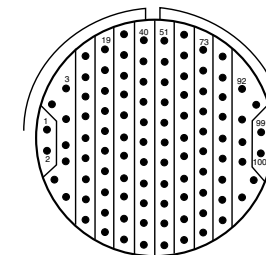
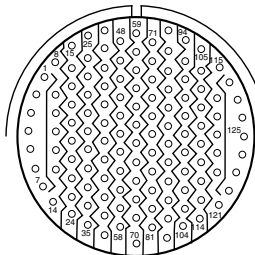
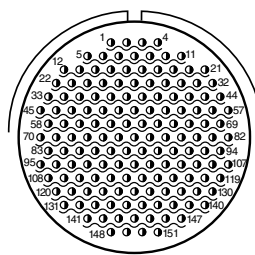

CONTACT LEGEND 8 10 12 16 20 22 22M 22D 23

HD: High Density HD38999 (use size 23 contacts only)

38999

- III
- HD
- Dualok
- II
- I
- SJT
- Accessories
- Aquacon
- Herm/Seal
- PCB

- HIGH SPEED
- Fiber Optics
- Contacts Connectors Cables

EMI Filter Transient

26482 Matrix 2

83723 III Matrix | Pyle

26500 Pyle

5015 Crimp Rear Release Matrix

22992 Class I

Back-Shells

Options Others

Front face of pin inserts illustrated

38999

- III
- HD
- Dualok
- II
- I
- SJT
- Accessories
- Aquacon
- Herm/Seal
- PCB

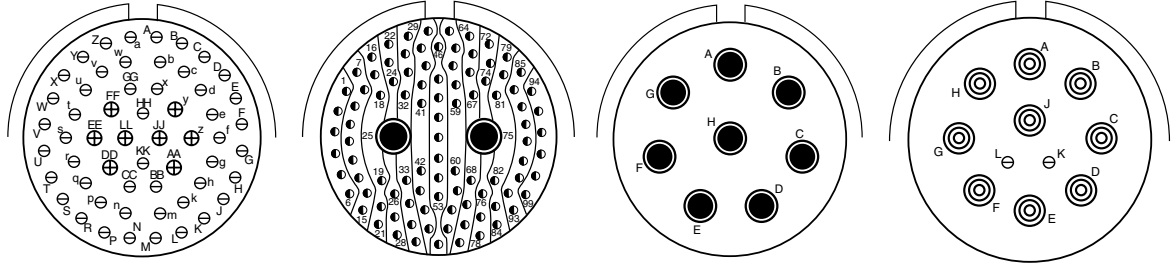

Shell Size & Insert Arrg. for:

Series	24-4	25-7	25-8	25-11***
Series II JT	24-4			
Series I LJT	25-4	25-7		25-11
Series III TV	25-4	25-7	25-8	25-11***
Service Rating	I	M	Twinax	N
Number of Contacts	48 8	97 2	8	2 9
Contact Size	20 16	22D 8 Twinax	8 Twinax	20 10

- HIGH SPEED
- Fiber Optics
- Contacts Connectors Cables

- EMI Filter Transient

- 26482 Matrix 2

- 83723 III Matrix | Pyle

- 26500 Pyle

- 5015 Cimp Rear Release Matrix

- 22992 Class I

- Back-Shells

- Options Others

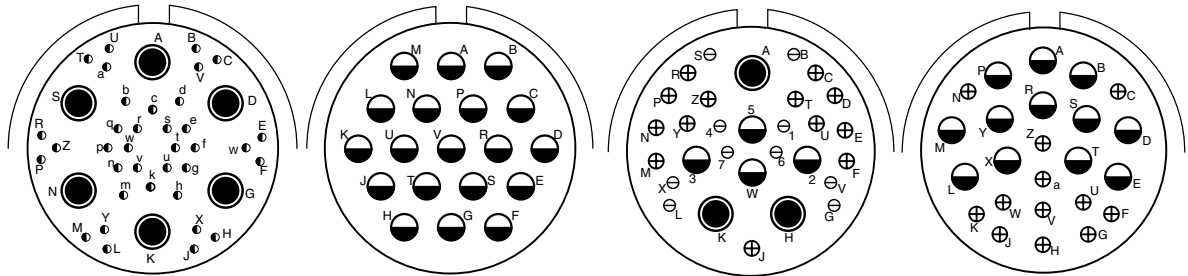

Shell Size & Insert Arrg. for:

Series	24-19	25-19	25-20	25-24
Series II JT	24-19			
Series I LJT	25-19	25-19	25-20	25-24
Series III TV	25-17	25-19	25-20***	25-24
Service Rating	M	I	N	I
Number of Contacts	36 6	19	10 13 3 4	12 12
Contact Size	22D 8 Twinax	12	20 16 8 Twinax 12 Coax	16 12

(With Matched Impedance)

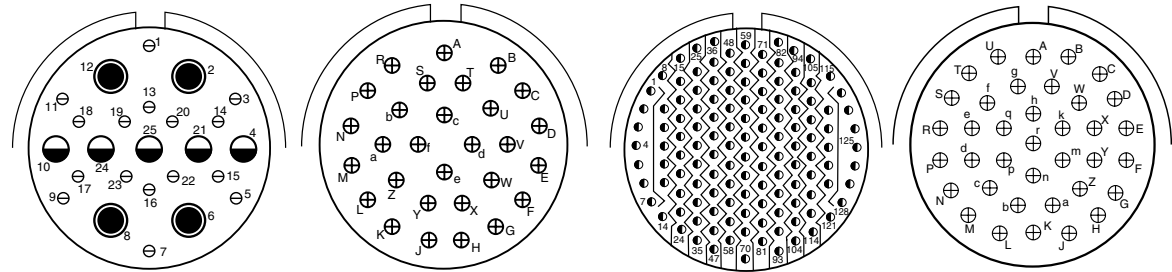

Shell Size & Insert Arrg. for:

Series	24-29	25-29	25-35	25-37
Series II JT	24-29			
Series I LJT	25-29	25-29	25-35	25-37
Series III TV	25-26	25-29	25-35	25-37
Service Rating	I	I	M	I
Number of Contacts	16 5 4	29	128	37
Contact Size	20 12 8 Coax	16	22D	16

*** For use in MIL-STD-1760 applications (see pages 43 and 44).

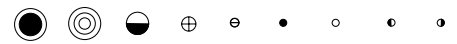

CONTACT LEGEND 8 10 12 16 20 22 22M 22D 23

Front face of pin inserts illustrated

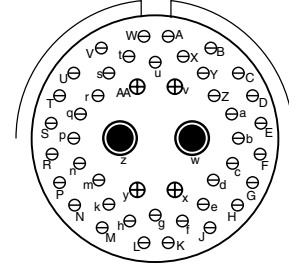
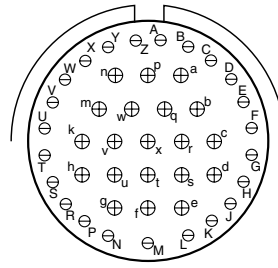

Shell Size & Insert Arrg. for:

Series	Shell Size & Insert Arrg.	Service Rating	N/Inst.			I	
Series II JT	25-43						
Series I LJT	25-43				23	20	
Series III TV	25-43				25-43	25-46	
Number of Contacts			22	3	11	2	3
Contact Size			22D	20	16	12 Coax	8 Twinax

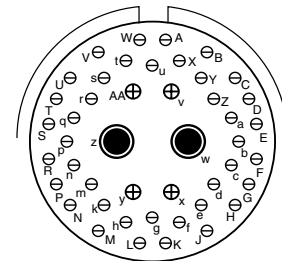
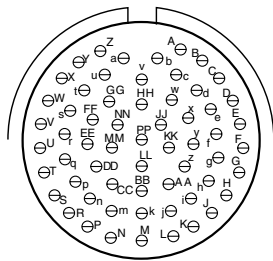

Shell Size & Insert Arrg. for:

Series	Shell Size & Insert Arrg.	Service Rating	I			
Series II JT	24-61					
Series I LJT	25-61					
Series III TV	25-61					
Number of Contacts			61	8	4	
Contact Size			20	16	8	

Ground Plane Only

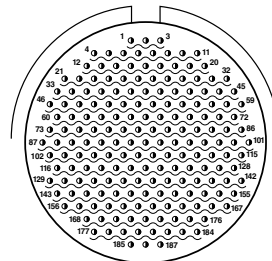
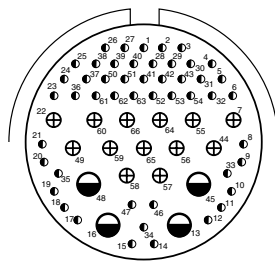

Shell Size & Insert Arrg. for:

Series	Shell Size & Insert Arrg.	Service Rating	Size 22D=M, Balance =I			N
Series II JT	25-F4					
Series I LJT	25-187 HD					
Series III TV	25-187 HD					
Number of Contacts			49	13	4	187
Contact Size			22D	16	12	23

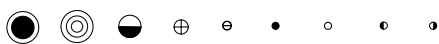

CONTACT LEGEND 8 10 12 16 20 22 22M 22D 23

† Coax contacts for RG180/U or RG195/U cable.

HD: High Density HD38999 (use size 23 contacts only)

38999

- III
- HD
- Duallok
- II
- I
- SJT
- Accessories
- Aquacon
- Herm/Seal
- PCB

- HIGH SPEED
- Fiber Optics
- Contacts Connectors Cables

EMI Filter Transient

26482 Matrix 2

83723 III Matrix | Pyle

26500 Pyle

5015 Crimp Rear Release Matrix

22992 Class I

Back-Shells

Options Others

38999

Front face of pin inserts illustrated

- III
- HD
- Dualok
- II
- I
- SJT
- Accessories
- Aquacon
- Herm/Seal
- PCB

- HIGH SPEED
- Fiber Optics
- Contacts Connectors Cables

- EMI Filter Transient

- 26482 Matrix 2

- 83723 III Matrix | Pyle

- 26500 Pyle

- 5015 Crimp Rear Release Matrix

- 22992 Class I

- Back-Shells

- Options Others

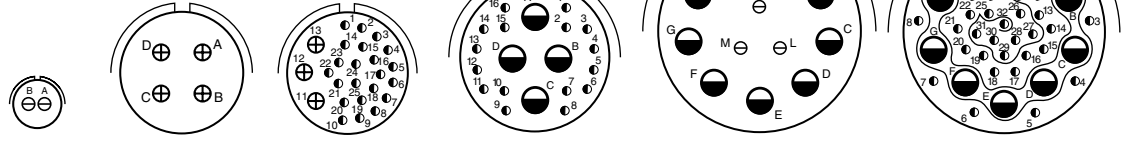

Shell Size & Insert Arrg. for:

Series III TV	9-2	15-4*	15-25	17-20	21-12	21-21
Service Rating	I	II	M	M	I	M/Inst.
Number of Contacts	2	4	22 3	16 4	3 9	32 9
Contact Size	20	16	22D 16	22D 12	20 12	22D 12

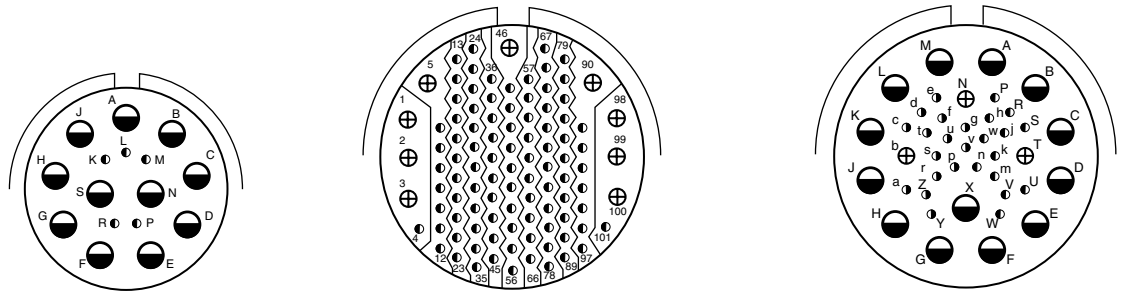

Shell Size & Insert Arrg. for:

Series III TV	21-99	25-92	25-97
Service Rating	M	M	M
Number of Contacts	5 11	92 9	26 3 13
Contact Size	22D 12	22D 16	22D 16 12

NOTE: Some specials shown here were formerly known as Pyle arrangements. Consult Amphenol for how to order information for connectors with these inserts. For further information on special arrangements consult Amphenol Aerospace, Sidney NY.

* Pyle 15-4 does not mate with Amphenol Tri-Start 15-4 insert.



CONTACT LEGEND 8 10 12 16 20 22 22M 22D 23*

Front face of pin inserts illustrated

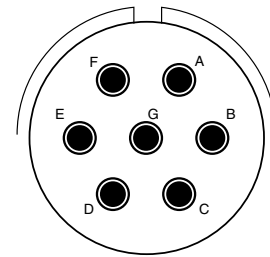
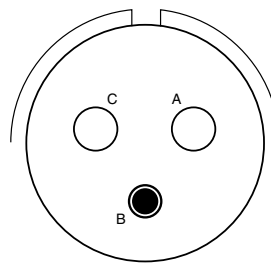
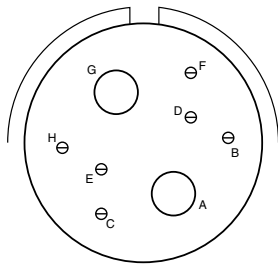

Shell Size & Insert Arrg. for:

Series III TV	25-16	25L-3	25L-7
Service Rating	M	II	II
Number of Contacts	6 2	1 2	7
Contact Size	20 4	8 4	8

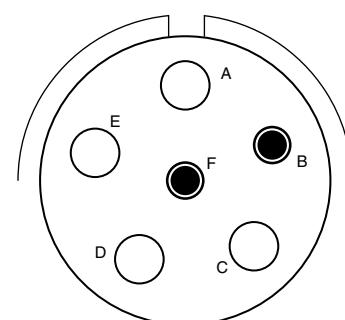
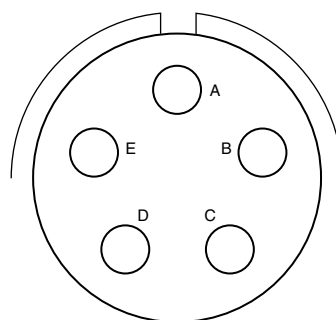
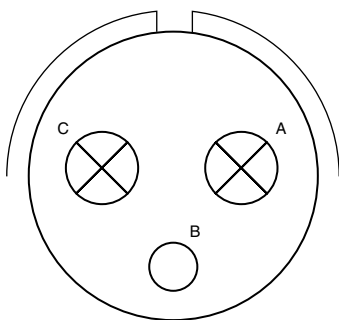

Shell Size & Insert Arrg. for:

Series III TV	33-3	33-5	33-6
Service Rating	II	II	II
Number of Contacts	1 2	5	2 4
Contact Size	4 0	4	8 4



Shell Size & Insert Arrg. for:

Series III TV	37-5
Service Rating	II
Number of Contacts	4
Contact Size	0

NOTE: Some specials shown here were formerly known as Pyle arrangements. Consult Amphenol for how to order information for connectors with these inserts.

Consult Amphenol Aerospace for longer shell drawings.

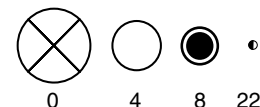

CONTACT LEGEND

38999

III
HD
Dualok
II
I
SJT
Accessories
Aquacon
Herm/Seal
PCB

HIGH SPEED
Fiber Optics
Contacts Connectors Cables

EMI Filter Transient

26482 Matrix 2

83723 III Matrix | Pyle

26500 Pyle

5015 Crimp Rear Release Matrix

22992 Class 1

Back-Shell's

Options Others

38999

III
HD
Dualok
II
I
SJT
Accessories
Aquacon
Herm/Seal
PCB

CONTACT RATING FOR TV III, HD, JT II, LJT I, SJT

Contact Size	Test Current (Amps)		Maximum Millivolt Drop Crimp*	Maximum Millivolt Drop	
	Crimp	Hermetic		Solder*	Hermetic*
23	5	3	73	20	85
22M	3	2	45	20	60
22D	5	3	73		85
22	5	3	73	20	85
20	7.5	5	55	20	60
16	13	10	49	20	85
12	23	17	42	20	85
10 (Power)	33	NA	33	NA	NA
8 (Power)	46	NA	26	NA	NA
4	80	NA	23	NA	NA
0	150	NA	21	NA	NA

Contact Size	Crimp Well Data		Solder Well Data	
	Well Diameter	Normal Well Depth	Well Diameter	Nominal Well Depth
23	.0345 ± .0010	.141	.0345 ± .0010	.130
22M	.028 ± .001	.141	.029 +.004 -.000	
22D	.0345 ± .0010	.141	.036 +.004 -.000	.094
22	.0365 ± .0010	.141	.036 +.004 -.000	.094
20	.047 ± .001	.209	.044 +.004 -.004	.125
16	.067 ± .001	.209	.078 +.000 -.004	.141
12	.100 ± .002	.209	.116 +.004 -.002	.141
10 (Power)	.137 ± .002	.355	NA	NA
8	.181 ± .002	.490	NA	NA
4	.281 ± .002	.490	NA	NA
0	.453 ± .002	.585	NA	NA

*When tested using silver plated wire.

SERVICE RATING**

Service Rating	Suggested Oper. Voltage (Sea Level)		Test Voltage (Sea Level)	Test Voltage 50,000 Ft.	Test Voltage 70,000 Ft.	Test Voltage 110,000 Ft.
	AC (RMS)	DC				
M	400	500	1300 VRMS	550 VRMS	350 VRMS	200 VRMS
N	300	450	1000 VRMS	400 VRMS	260 VRMS	200 VRMS
I	600	850	1800 VRMS	600 VRMS	400 VRMS	200 VRMS
II	900	1250	2300 VRMS	800 VRMS	500 VRMS	200 VRMS

**Please note that the establishment of electrical safety factors is left entirely in the designer's hands, since he is in the best position to know what peak voltage, switching surges, transients, etc. can be expected in a particular circuit.

MIL-DTL-38999 Series III STANDARD 500 CYCLE CONTACTS FOR TV AND CTV, P & S

Contact Size	TV/CTV Pins		TV/CTV Sockets	
	Military No.	Supersedes	Military No.	Supersedes
8 (Coax)*	M39029/60-367	MS27536	M39029/59-366	MS27535
8 (Power)	Contact Factory	"	"	"
8 (Twinax)	M39029/90-529**	N/A	M39029/91-530	N/A
10 (Power)	M39029/58-528	N/A	M39029/56-527	N/A
12	M39029/58-365	MS27493-12	M39029/56-353	MS27490-12
16	M39029/58-364	MS27493-16	M39029/56-352	MS27490-16
20	M39029/58-363	MS27493-20	M39029/56-351	MS27490-20
22D	M39029/58-360	MS27493-22D	M39029/56-348	MS27490-22D
4	N/A	N/A	N/A	N/A
0	N/A	N/A	N/A	N/A

MIL-DTL-38999 Series III SEALING PLUGS

Contact Size	Commercial No.	Military No.
8 (Coax)	10-482099-8	N/A
8 (Twinax)	T3-4008-59P	N/A
8 (Power)	10-405996-83	MS27488-8-3
10 (Power)	T3-4010-59P	M85049/81-10
12	10-405996-122	MS27488-12-2
16	10-405996-162	MS27488-16-2
20	10-405996-202	MS27488-20-2
22D	10-405996-222	MS27488-22-2
4	10-405996-43	MS27488-4-3
0	10-405996-03	MS27488-0-3

Above part numbers include standard 500 cycle finish designation - gold plating over suitable underplate in accordance with SAE AS39029. For other finish variations, consult Amphenol Aerospace.

*For use with RG180B/U and RG195A/U cable. For other size 8 coax or optional sizes 12 and 16 coax contacts available for use in Tri-Start connectors, see High Speed Contact section in this catalog or consult Amphenol Aerospace.

** For use with M17/M176-00002 cable.

† Optional design - see slash sheet MS39029.

For other contact options available for use in Tri-Start connectors (wire wrap, thermocouple, fiber optic), consult Amphenol.

MIL-DTL-38999 Series III 1500 CYCLE CONTACTS FOR CTV, CLASSES H & J

Contact Size	CTV Pins			CTV Sockets		
	Commercial No.	Military No.	Supersedes	Commercial No.	Military No.	Supersedes
12	10-597072-2X	M39029/107-623	-	10-597073-2X	M39029/106-617	-
16	10-597068-2X	M39029/107-622	-	10-597069-2X	M39029/106-616	-
20	10-597064-2X	M39029/107-621	-	10-597065-2X	M39029/106-615	-
22D	10-597058-3X	M39029/107-620	-	10-597061-2X	M39029/106-614	-

MIL-DTL-38999 Series II JT/ Series I LJT/SJT Series CRIMP CONTACTS

Contact Size	JT/LJT/SJT Pins MS No.	JT Socket MS No.	LJT/SJT Sockets MS No.	Contact Size	JT/LJT Pins MS No.	JT Socket MS No.	LJT/SJT Sockets MS No.
8 (Coax)*	M39029/60-367	NA	M39029/59-366	20	M39029/58-363	M39029/57-357	M39029/56-351
8 (Twinax)	M39029/90-529**	NA	M39029/91-530	22	M39029/58-362	M39029/57-356	M39029/56-350
10 (Power)	M39029/58-528	NA	M39029/56-527	22M	M39029/58-361	M39029/57-355	M39029/56-349
12	M39029/58-365	M39029/57-359	M39029/56-353	22D	M39029/58-360	M39029/57-354	M39029/56-348
16	M39029/58-364	M39029/57-358	M39029/56-352				

HIGH SPEED
Fiber Optics

Contacts Connectors Cables
EMI Filter Transient

26482 Matrix 2

83723 III Matrix I/Pyle

26500 Pyle

5015 Crimp Rear Release Matrix

22992 Class I

Back-Shells

Options Others

THERMOCOUPLE CONTACTS Series II JT/ I LJT

Contact Size	Material	JT/LJT Pins	JT Sockets	LJT Sockets
20	Chromel	10-407862-310	10-407863-310	10-407236-310
	Alumel	10-407862-320	10-407863-320	10-407865-320
	Iron	10-407862-335	10-407863-335	10-407865-335
	Constantan	10-407862-342	10-407863-342	10-407865-342

Partial Listing. If you do not see the contact for your application, consult Amphenol Aerospace.

THERMOCOUPLE CONTACTS PYLE VERSION Series II JT/ I LJT

Contact Size	Pins (II JT/ I LJT)		Sockets (LJT)		Material
	Spec Number	Pyle Number	Spec Number	Pyle Number	
22D	M39029/87-472	T3-4022-10P	M39029/88-484	T3-4122-10P	CHROMEL
22D	M39029/87-471	T3-4022-10R	M39029/88-483	T3-4122-10R	ALUMEL
20	M39029/87-476	T3-4020-10P	M39029/88-488	TS-4120-10P	CHROMEL
20	M39029/87-475	T3-4020-10R	M39029/88-487	T3-4120-10R	ALUMEL
16	M39029/87-480	T3-4016-10P	M39029/88-492	T3-4116-10P	CHROMEL
16	M39029/87-479	T3-4016-10R	M39029/88-491	T3-4116-10R	ALUMEL

Above part numbers include standard finish designation - gold plating over suitable underplate in accordance with MIL-DTL-39029. For other finishes, consult Amphenol Aerospace. Note: 22M and 22D contacts are interchangeable. *For use with RG180B/U and RG195A/U cable. For other size 8 coax or optional sizes 12 and 18 coax contacts available for use in JT/LJT connectors, see High Speed Contacts section of this catalog.** For use with 17/M176-00002 cable.

SEALING PLUGS Series II JT/ I LJT

Contact Size	Commercial No.	Military No.
8 (Coax)	10-482099-8	MS27488-8
8 (Twinax)	T3-4008-59P	N/A
10 (Power)	10-576225	N/A
12	10-405996-122	MS27488-12-2
16	10-405996-162	MS27488-16-2
20	10-405996-202	MS27488-20-2
22	10-405996-222	MS27488-22-2
22M	10-405996-222	MS27488-22-2
22D	10-405996-222	MS27488-22-2

SEALING PLUGS SJT

Contact Size	Commercial No.
8 (Coax)	10-482099-8
8 (Twinax)	10-482099-8
10 (Power)	NA
12	10-405996-012 Yellow
16	10-405996-016 Blue
20	10-405996-020 Red
22	10-405996-022 Black
22M	10-405996-022 Black
22D	10-405996-022 Black

FINISH DATA MIL-DTL-38999, Tri-Start Series III TV

Aluminum Shell Components Non-Hermetic*		
Finish	Service Class	
	Military	Commercial
Anodic Coating (Non-Conductive)	C*	RX**
Electroless Nickel	F (Metal)*	RF
	M (Composite)	
Olive Drab Cadmium Plate Nickel Base	W (Metal)*	RW
	J (Composite)	
Stainless Steel with Nickel Plate (non-firewall)	L	
Stainless Steel with Nickel Plate (firewall)	S	RS
	K	RK
Stainless Steel	T*	DT
Durmalon plated	Z*	DZ

Hermetic Shell Components		
Material/Finish	Service Class	
	Military	Commercial
Stainless Steel	Y	Y
Stainless Steel with Nickel Plate	N	YN

**Add Suffix (005) to part number.

FINISH DATA MIL-DTL-38999, Series I LJT, II JT

Finish	Aluminum Shell Components Non-Hermetic			Indicated Finish Standard for JT Types Listed Below	Indicated Finish Standard for LJT Types Listed Below
	Military	Commercial	Finish Plus "SR" Suffix		
Cadmium Plated Nickel Base	MS (A)	-	(SR)	JT/JTG/JTL/JTP	LJT/LJTP
Anodic Coating (Alumilite)	MS (C)	(005)	(300)	JTS/JTPS/JTLS	LJTSP/LJTS
Chromate Treated (Iridite 14-2)		(011)	(344)	JTN/JTPN/JTLN	LJTNP/LJTPN
Olive Drab Cadmium Plate Nickel Base	MS (B)	(014)	(386)		
Electroless Nickel	MS (F)	(023)	(424)		
Nickel-PTFE Durmalon		(038)			

Finish	Hermetic Connectors		Indicated Finish Standard for JT Types Listed Below	Indicated Finish Standard for LJT Types Listed Below
	Military	Commercial		
Carbon Steel Shell Tin Plated Shell and Contacts			JT()H / JT()Y JTL()H / JTL()Y	LJT()Y LJT()H
Carbon Steel Shell Tin Plated Shell and Gold Plated Contacts	MS (D)			
Stainless Steel Shell Gold Plated Contacts	MS (E)	(162)	JTS()Y JTLS()Y	LJTS()Y

38999

III

HD

Dualok

II

I

SJT

Accessories

Aquacon

Herm/Seal

PCB

HIGH SPEED

Fiber Optics

Contacts Connectors Cables

EMI Filter Transient

26482 Matrix 2

83723 III Matrix | Pyle

26500 Pyle

5015 Crimp Rear Release Matrix

22992 Class 1

Back-Shell's

Options Others



Tri-Start™ MIL-DTL-38999 Series III with Metal Shells - Aluminum, Stainless Steel, Class K Firewall

Amphenol® Tri-Start MIL-DTL-38999* Series III Connectors offer the highest performance capabilities for both general duty and severe environment applications. Meeting or exceeding MIL-DTL-38999 Series III requirements, the Tri-Start connector with standard metal shells (aluminum or stainless steel with several finish options) offers these features:

- **EMI Shielding** - solid metal-to-metal coupling, grounding fingers, electroless nickel plating, and thicker wall sections provide superior EMI shielding capability of 65dB minimum at 10 GHz
- **Contact Protection** - recessed pins in this 100% scoop-proof connector minimize potential contact damage
- **Moisture Resistance** - improved interfacial seal design helps prevent electrolytic erosion of contacts
- **Corrosion Resistance** - shells of stainless steel or cadmium over nickel plating withstand a 500 hour salt spray exposure
- **Vibration/Shock** - operates under severe high temperature vibration, through 200°C
- **Firewall Capability** - available in a stainless steel shell, class RK, RS
- **Lockwiring Eliminated** - unique, self-locking, quick coupling connector eliminates lockwiring
- **Quick Coupling** - completely mates and self-locks in a 360° turn of the coupling nut
- **Inventory Support Commonality** - uses standard MIL-DTL-38999 contacts, application tools, insert arrangements
- **Electrostatic Discharge Protection (ESD)** - protection for sensitive circuitry without diodes, varistors, etc., with the use of the Faraday Cage principle which shunts high voltage, high current discharge events (see page 331)
- **Hermetic**- air leakage limited to 1 X 10⁻⁷ cm³ per second optional
- **Qualified Specifications** - Stainless Steel qualified to BACC63DB and BACC63DC specifications

Optional Shell Geometries

Amphenol offers a number of different shell configurations to fit your needs.

- Deep Reach Shells - For increased panel thickness
- Stand-off Flange Shells - For attachments to Printed Circuit Boards.
- Connector with Integral Strain Reliefs

* MIL-DTL-38999 Series III supersedes MIL-C-38999 Series III.

Applicable Patents:

Tri-Start™ Connector Patent 4,109,990.

Composite Connector Patents:

4,268,103; 4,648,670; 4,682,832; 4,703,987.

Clutch-Lok® Patent 6,152,753.



Series III Composite Tri-Start, Qualified to MIL-DTL-38999, Rev. J

MIL-Qualified to MIL-DTL-38999, Rev. K, the Amphenol® Composite Tri-Start Connector offers a lightweight, corrosion resistant connector with the same high performance features as its metal counterpart. The Composite Tri-Start Connector also includes the following features:

- **Lightweight** - 17% – 70% weight savings (17–40% weight savings vs. Aluminum) (60–70% weight savings vs. Stainless steel) See Composite weight comparison chart on page 23.
- **Corrosion Resistance** - available in standard MIL-DTL-38999 olive drab cadmium (-65°C to 175°C) and electroless nickel plating (-65°C to 200°C), both withstanding 2000 hours of salt spray exposure. The base material is able to withstand an indefinite exposure to salt spray.
- **Durability** - 1500 couplings minimum (in reference to connector couplings, not contacts)
- **Extended Life Contact** - Mil-approved plating process which provides 1500 couplings minimum
- Qualified to BACC63CT and BACC63CU specifications



CLUTCH-LOK™ MIL-DTL-38999 Series III High Vibration Connector

The Tri-Start option CLUTCH-LOK offers all advantages of stainless steel/Class K firewall for MIL-DTL-38999 Series III connectors, plus a unique clutch design that actually tightens itself under vibration. Features include:

- High degree of differential torque
- No settling back to the next ratchet tooth
- Completely intermateable with all existing MIL-DTL-38999 Series III connectors
- Offers advantage in inaccessible, hard to reach areas where mating torque is difficult to apply and complete coupling is not verifiable by inspection

See page 32 for description, 25 – 27 for ordering.

38999

III
HD
Dualok
II
I
SJT
Accessories
Aquacon
Herm/Seal
PCB

HIGH SPEED
Fiber Optics
Contacts Connectors Cables

EMI Filter Transient

26482 Matrix 2

83723 III Matrix Pyle

26500 Pyle

5015 Crimp Rear Release Matrix

22992 Class I

Back-Shells

Options Others

Series III, TV Tri-Start Connectors, offer more versatility & options than any other interconnection family!

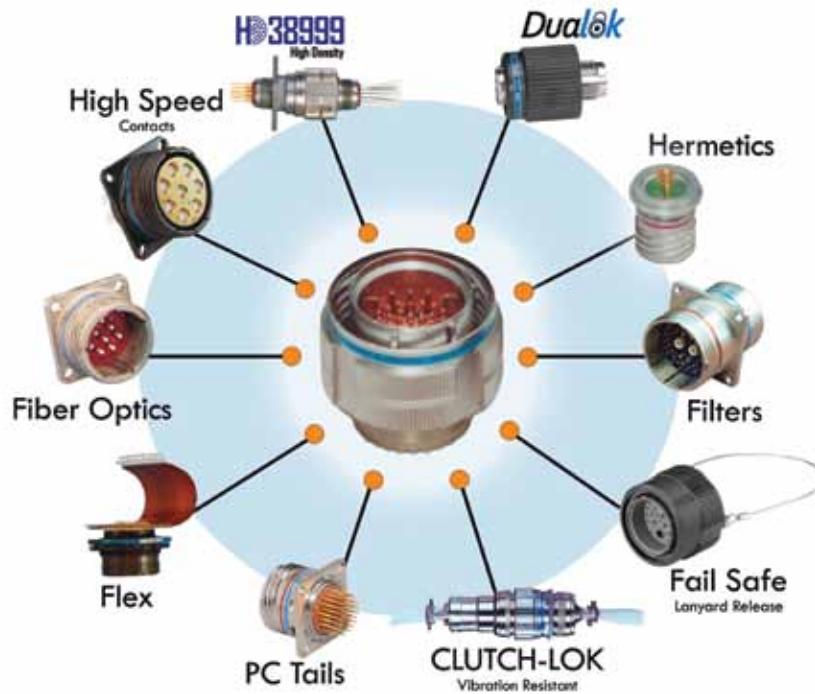

High reliability and increased versatility best describe Amphenol MIL-DTL-38999, Series III circular connectors. Originally designed for the harshest of environments and most demanding of applications, Amphenol MIL-DTL-38999 Series III, Tri-Start connectors continue to evolve in pace with the needs of an ever-changing market.

Amphenol Tri-Start connectors can be configured with a number of application specific technologies like High Density HD38999, Duallok, Filters, Hermetics, PC Tails, Fiber Optics, Flex, CLUTCH-LOK, Fail Safe, and contacts. Flexibility aids in design optimization through the combination of different technologies within a common, time-tested, harsh environment connector body.

For more information about options, please call 800-678-0141 or visit www.amphenol-aerospace.com.

Performance

Designed for Performance

Numerous advantages in performance capability are designed into the Amphenol Tri-Start Connector. A positive metal to metal coupling design, grounding fingers, and electroless nickel plating provide superior EMI shielding capability of 65 dB minimum at 10 GHz.

Acme threads provide coupling durability. Thicker wall sections and a greater coupling surface area improve strength and shock resistance. Blunting of the thread on both the coupling nut and receptacle eliminates cross coupling. The connector quickly mates and self locks in a 360° turn of the coupling nut.

Elongated mounting holes permit the Tri-Start Connector to intermount with various existing MIL-Spec box or wall mount receptacles, giving it a design replacement advantage.

Shells of stainless steel or cadmium over nickel plating prevent severe corrosion. Resistance is tested through exposure to a 500 hour salt spray. Composite versions provide protection from salt spray exposure for 2000 hours. Other finish options are available; see how to order Tri-Start metal and Tri-Start Composite.

Recessed pins minimize potential contact damage in this 100% scoop-proof connector. In a blind mating application, mating shells cannot “scoop” the pins and cause a shorting or bending of contacts.

The design of the Amphenol Tri-Start interfacial seal meets the MIL-DTL-38999 Series III requirements for electrolytic erosion resistance.

A rigid dielectric insert with excellent electrical characteristics provides durable protection to the contacts. The socket contacts are probe proof, and all contacts are rear removable. They are plated in the standard 50 micro inches minimum gold, with 100 micro inches as an option, and are available in standard Tri-Start insert arrangements and special Pyle® insert arrangements in sizes 10 power, 12, 16, 20 and 22D contacts. Special insert patterns are also available with larger contacts in sizes 4 and 0.

38999

III

HD

Dualok

II

I

SJT

Accessories

Aquacon

Herm/Seal

PCB

HIGH SPEED

Fiber Optics

Contacts
Connectors
Cables

EMI Filter
Transient

26482
Matrix 2

83723 III
Matrix | Pyle

26500
Pyle

5015
Crimp Rear Release
Matrix

22992
Class I

Back-
Shells

Options
Others

MIL-DTL-38999, Series III TV

Weight Comparisons (Composite vs. Metal)

Depending on the shell style, shell size and contact count, weight savings can range from 17% to 40% compared to standard aluminum product.

Tri-Start Weight in Ounces (includes contacts)

Weight

	Wall Mount Receptacle (00 • Military D38999/20)						Jam Nut Receptacle (07) • Military D38999/24						Plug (06) • Military D38999/26					
	Stainless Steel		Aluminum		Composite		Stainless		Aluminum		Composite		Stainless Steel		Aluminum		Composite	
	Pin	Socket	Pin	Socket	Pin	Socket	Pin	Socket	Pin	Socket	Pin	Socket	Pin	Socket	Pin	Socket	Pin	Socket
9-35	.7216	.7840	.3248	.3777	.2588	.3121	1.1472	1.2096	.4416	.5040	.3489	.4413	1.0736	1.1360	.4236	.4625	.2606	.2994
9-98	.7216	.7776	.2496	.3056	.1664	.2224	1.1472	1.2032	.4416	.4976	.3744	.4640	1.0736	1.1296	.3968	.4624	.2991	.2337
11-35	.9488	1.0800	.3632	.4960	.2753	.4081	1.4304	1.5632	.5936	.7264	.4679	.6007	1.2480	1.3808	.5312	.6389	.3450	.4582
11-98	.9488	1.0620	.3632	.4768	.2753	.3889	1.4304	1.5440	.5936	.7072	.4679	.5815	1.2480	1.3616	.5330	.6283	.3468	.4457
13-8	1.2096	1.3888	.4800	.6592	.3696	.5488	1.9104	2.0896	.7664	.9456	.6560	.8352	1.8048	1.9840	.7936	.9728	.5237	.5952
13-35	1.2160	1.4320	.4864	.7024	.3762	.5922	1.9168	2.1328	.7728	.9888	.6136	.8296	1.8112	2.0272	.8000	.8472	.5301	.6531
13-98	1.2160	1.4016	.4864	.6720	.3762	.5618	1.9168	2.1024	.7728	.9584	.6136	.7992	1.8112	1.9968	.7978	.9856	.5244	.7157
15-5	1.5312	1.7904	.6352	.8944	.5027	.7619	2.3792	2.6384	.9728	1.2320	.7749	1.0341	2.2704	2.5456	.9632	1.1719	.6450	.8467
15-18	1.5456	1.8416	.7760	.9456	.6432	.8128	2.3936	2.6896	.9872	1.2832	.8544	1.1504	2.2848	2.5808	.9776	1.2736	.6594	.8208
15-35	1.5424	1.8768	.6464	.9808	.5139	.8483	2.3904	2.7344	.9840	1.3280	.7861	1.1301	2.2816	2.6256	1.2179	1.3184	.8961	1.0002
17-6	2.1488	2.5904	.9360	1.3776	.7812	1.2228	2.9152	3.3568	1.2336	1.6752	.9940	1.4356	2.5008	3.1024	1.1408	1.7424	.8160	1.4176
17-26	2.1344	2.5600	.9216	1.3472	.7668	1.1924	2.9008	3.3264	1.2192	1.6448	.9796	1.4052	2.4864	2.9120	1.1264	1.3343	.8017	.8062
17-35	2.1360	2.6640	.9232	1.4512	.7684	1.2964	2.9024	3.4304	1.2208	1.7488	.9812	1.5092	2.4880	3.0160	1.1280	1.5497	.8033	1.2144
19-11	2.2592	2.6656	.9696	1.4528	.7925	1.2757	3.4352	3.9184	1.4720	1.9552	1.2033	1.6865	2.9808	3.4640	1.3472	1.8304	.9632	1.4464
19-32	2.1888	2.7264	.9760	1.5136	.7989	1.3365	3.4416	3.9792	1.4784	2.0160	1.2097	1.7473	2.9872	3.5248	1.3536	1.8912	.9696	1.5072
19-35	2.1920	2.8432	.9792	1.6304	.8021	1.4533	3.4448	4.0960	1.4816	2.1328	1.2129	1.8641	2.9904	3.6416	1.3568	2.0080	.9728	1.6240
21-11	2.7456	3.4640	1.3088	2.0272	1.1088	1.8272	3.9712	4.6896	1.8128	2.5312	1.6128	2.3312	3.4448	4.1632	1.7344	2.5312	1.3039	1.8710
21-16	2.6784	3.3168	1.2416	1.8800	1.0422	1.6806	3.9040	4.5424	1.7456	2.3840	1.4505	2.0889	3.3776	4.0160	1.6672	2.3168	1.2352	1.8736
21-35	2.6672	3.4992	1.2304	2.0624	1.0310	1.8630	3.8928	4.7248	1.7344	2.5664	1.4393	2.2713	3.3664	4.1984	1.6560	2.2309	1.2255	1.8003
21-41	2.6768	3.3600	1.2400	1.9232	1.0406	1.7238	3.9024	4.5856	1.7440	2.4272	1.4489	2.1321	3.3760	3.5792	1.6656	1.8688	1.2336	1.4368
23-21	3.0352	3.8624	1.4496	2.2768	1.2279	2.0551	4.2368	5.0640	1.9440	2.7712	1.6368	2.4640	3.7920	4.6192	1.9216	2.7488	1.4637	2.2896
23-35	3.0240	4.0448	1.4384	2.4592	1.2167	2.2375	4.2256	5.2464	1.9328	2.9536	1.6256	2.6464	3.7808	4.8016	1.9104	2.6087	1.4525	2.1507
23-53	2.8992	3.9072	1.4560	2.4816	1.2343	2.2599	4.2432	5.1088	1.9504	2.8160	1.6432	2.5088	3.7984	4.6640	1.9280	2.7936	1.4672	2.2384
25-4	3.4512	4.4800	1.7312	2.8816	1.4864	2.1904	4.8048	5.8272	2.2016	3.2480	1.9568	2.8720	4.2224	5.2496	2.2128	3.2560	1.7133	2.4163
25-19	3.5312	4.7264	1.8112	3.0064	1.5664	2.7616	4.8848	6.0816	2.2816	3.4784	2.0368	3.2336	4.3024	5.4992	2.2928	3.4896	1.7933	2.7058
25-20	3.8190	4.7150	2.0173	3.1125	1.7733	2.8512	5.1430	6.0380	2.4877	3.5421	2.1872	3.2416	4.4350	5.3300	2.2580	3.0182	1.8288	2.8928
25-35	3.4416	4.6656	1.7216	2.9456	1.4776	2.7016	4.7952	6.0192	2.1920	3.4160	1.8915	3.1155	4.2128	5.4368	2.2032	3.4272	1.7037	2.9277
25-61	3.4304	4.4848	1.7282	2.7648	1.4841	2.5208	4.7840	5.8384	2.1808	3.2352	1.8803	2.9347	4.2016	5.2560	2.1920	3.2464	1.6912	2.7456

All weight measurements are for reference only.

38999

- III
- HD
- Dualok
- II
- I
- SJT
- Accessories
- Aquacon
- Herm/Seal
- PCB

- HIGH SPEED
- Fiber Optics
- Contacts Connectors Cables

EMI Filter
Transient

26482
Matrix 2

83723 III
Matrix | Pyle

26500
Pyle

5015
Crmp Rear Release Matrix

22992
Class 1

Back-Shell's

Options
Others

38999

- III
- HD
- Dualok
- II
- I
- SJT
- Accessories
- Aquacon
- Herm/Seal
- PCB

HIGH SPEED

- Fiber Optics
- Contacts
- Connectors
- Cables

EMI Filter Transient

26482 Matrix 2

83723 III Matrix | Pyle

26500 Pyle

5015 Crimp Rear Release Matrix

22992 Class I

Back-Shells

Options Others

TRI-START, SERIES III TYPICAL SHIELDING EFFECTIVENESS TEST DATA

EMI/EMP SHIELDING EFFECTIVENESS dB
TESTING BY TRIAXIAL METHOD

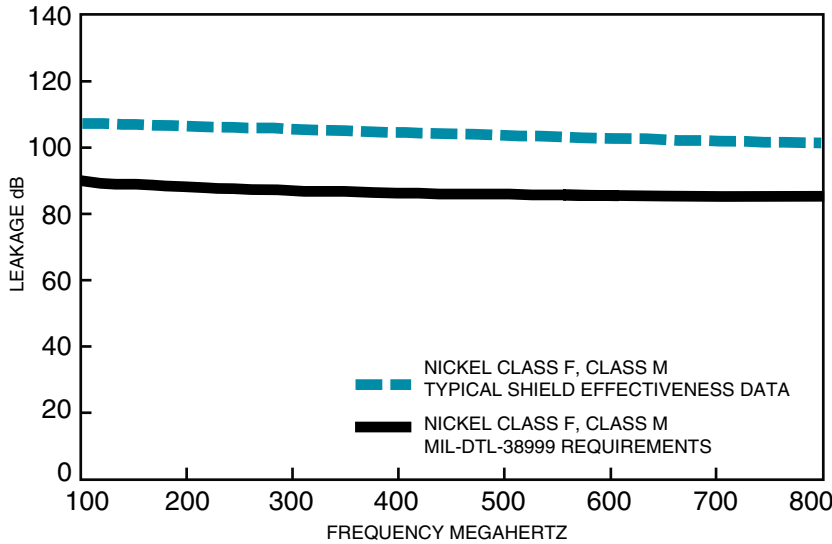

Amphenol® Tri-Start connectors provide EMI/EMP shielding capability which exceeds MIL-DTL-38999 Series III requirements.

The TV and CTV Series III connector with standard solid metal-to-metal coupling, EMI grounding fingers and conductive finishes have proven to be the ultimate in EMI/EMP shielding effectiveness. The charts illustrate shielding effectiveness data which is typical of Tri-Start connectors tested with the nickel finish (Class F-metal, Class M-composite) over a wide frequency range.

The vibration capability of the Tri-Start Series is shown in the chart below. This illustrates the most severe vibration envelope of any qualified connector available today. These capabilities along with a +200°C, -65°C temperature rating and superior moisture sealing protection provide the user with a connector that can withstand the most rigorous application.

TRI-START, SERIES III TYPICAL SHIELDING EFFECTIVENESS TEST DATA

EMI/EMP SHIELDING EFFECTIVENESS dB
TESTING BY MODE STIRRING METHOD

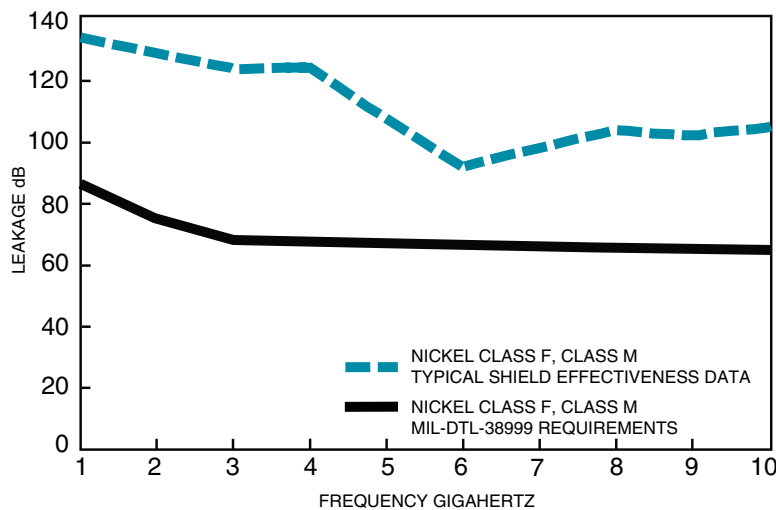

TRI-START VIBRATION CRITERIA

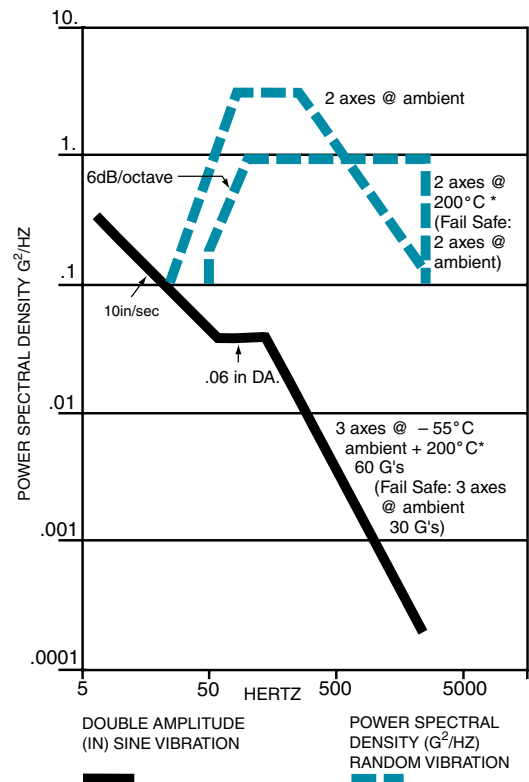

* Dependant on shell finish

Test data beyond 2GHz is subject to equipment variation.

NOTE: For test data information on the new Clutch-Lok Tri-Start, high vibration connectors, consult Amphenol Aerospace.

Easy Steps to build a part number... Tri-Start Series III TV

1.	2.	3.	4.	5.	6.	7.
Commercial	Shell Style	Service Class	Shell Size– Insert Arrangement	Contact Type	Alternate Keying Position	Special Variations
TVPS	00	RF	9-35	P	B	(XXX)
Military	Shell Style	Service Class	Shell Size– Insert Arrangement	Contact Type	Alternate Keying Position	
D38999/	20	J	G35	P	N	

Step 1. Select a Connector Type

Do you need a Mil-Spec marked connector?

Military-MIS-Spec Market	
D38999	Military MIL-DTL-38999 Series III Connector

If you don't need Mil-Spec Marked Connector select from the choices below.

Next question to help you decide. What Shell Material & Temperature rating do you need?

Aluminum 175°C	
TV	Tri-Start 175°C
TVP	Panel mounted receptacle 175°C
Aluminum, Aluminum Bronze & Steel 200°C	
TVS	200°C rated
TVPS	Panel mounted, 200°C rated receptacle
Composite 175°C	
CTV	Composite 175°C
CTVP	Panel mounted composite receptacle 175°C
Composite 200°C	
CTVS	200°C rated, composite
CTVPS	Composite Panel mounted, 200° rated receptacle
Steel 200°C	
MTV	CLUTCH-LOK connector with "MS" stamping (Note: remove dashes in how to order part number when ordering CLUTCH-LOK)

Step 2. Select a Shell Style

COMMERCIAL				MILITARY			Designates
TVP, TVPS, CTVP, CTVPS	TV, CTV	TVS	CTVS	CLUTCH-LOK	D38999 Military	D38999 Military Composite	
00					20	20	Wall Mount Receptacle
02							Box Mount Receptacle
					21		Box Mount Receptacle Hermetic
	01	01	01				Line Receptacle
	06	06	06		26	26	Straight Plug
	07	07	07		24	24	Jam Nut Receptacle
	09	09					Flange Mounted Plug
					23		Jam Nut Receptacle Hermetic
		I			25		Solder Mount Receptacle Hermetic
		HI			27		Weld Mounted Receptacle, (Hermetic) Only
	56	56	56				Straight plug with Dualok
				26		26	CLUTCH-LOK high vibration straight plug (Class RK only)
					29		Lanyard release plug with pin contacts
					30		Lanyard release plug with socket contacts
					31		Lanyard release plug for MIL-STD-1760 with pin contacts
					32		Plug protection cap
					33		Receptacle protection cap

Wall Mount Receptacle (00, 20)



Line Receptacle (01)



Box Mount Receptacle (02, 21)



Straight Plug (06)



Jam Nut Receptacle (07, 24)



Flange Mounting Plug (09)



Deep Reach Receptacle Consult Amphenol Aerospace



Solder Mount Hermetic Receptacle (I, 25)



Lanyard Release Plug (29, 30, 31)

38999

III
HD
Dualok
II
I
SJT
Accessories
Aquacon
Herm/Seal
PCB

HIGH SPEED
Fiber Optics
Contacts Connectors Cables

EMI Filter Transient

26482 Matrix 2

83723 III Matrix | Pyle

26500 Pyle

5015 Crimp Rear Release Matrix

22992 Class 1

Back-Shell's

Options Others

38999

Step 3. Select a Service Class

1. Connector Type	2. Shell Style	3. Service Class RX	4. Shell Size-Insert Arrg.	5. Contact Type	6. Alternate Position	7. Special Variations
-------------------	----------------	-------------------------------	----------------------------	-----------------	-----------------------	-----------------------

TV	TVP	CTV	CTVP	CTVS, CTVPS	TVS	TVPS	CLUTCH- LOK	Military	Finish	Description
					RB	RB			Aluminum Bronze	TBD Corrosion resistant aluminum bronze for marine & other high corrosion applications, 200°C.
								C	Anodic Coating	Non-conductive, anodic coated aluminum, 500 hour salt spray, 200°C.
RX	RX				RX	RX				TBD Consult Amphenol Aerospace for details, options and availability of non-cadmium or ROHS Compliant Finishes.
				RF-Composite	RF-Metal	RF-Metal		F-Metal M-Composite	Electroless Nickel	Electroless nickel plated aluminum (composite) optimum EMI shielding effectiveness -65dB @ 10GHz specification min., 48 hour salt spray, 200°C (Composite-2000 hours dynamic salt spray).
				RGF-Composite	RGF-Metal	RGF-Metal			Electroless Nickel	Electroless nickel plated ground plane aluminum (composite), 200°C
								G	Electroless Nickel	Space grade, electroless nickel, 48 hour salt spray, 200°C
RGW-Metal	RGW-Metal	RGW-Composite	RGW-Composite						Olive Drab Cadmium	Olive drab cadmium plated ground plane aluminum (composite), 175°C
					RK**	RK**	RK**	K	Passivated Stainless Steel	Corrosion resistant stainless steel, fire-wall capability, plus 500 hour salt spray resistance, EMI -45 dB @ 10 GHz specification min., 200°C
					RKN	RKN			Passivated Stainless Steel	Corrosion resistant stainless steel, non-firewall capability, plus 500 hour salt spray resistance, EMI -45 dB @ 10 GHz specification min., 200°C
					RL	RL		L	Stainless Steel w/ Nickel Plate	Corrosion resistant steel, electro deposited nickel, 500 hour salt spray, 200°C, non firewall, EMI shielding -65dB @ 10GHz specification min.
RW-Metal	RW-Metal	RW-Composite	RW-Composite					W-Metal J-Composite	Olive Drab Cadmium	Corrosion resistant olive drab cadmium plate aluminum (composite), 500 hour salt spray, EMI Shielding -50 dB@10 GHz specification min., 175°C (Composite - 2000 hours dynamic salt spray).
					Y	Y		Y	Stainless Steel	Hermetic seal, passivated stainless steel, 200°C
					RS*	RS*	RS*	S	Stainless Steel w/ Nickel Plate	(Non-hermetic connectors), Nickel plated, corrosion resistant steel, firewall capability, 500 hour salt spray, 200°, EMI shielding -65dB @ 10GHz specification min.
					YN	YN		N	Stainless Steel w/ Nickel Plate	(Hermetic connectors), Nickel plated corrosion resistant steel, 200°C
DT	DT							T	Durmalon plated	Nickel-PTFE alternative to Cadmium. Corrosion resistant, 500 hour salt spray, EMI -50dB at 10GHz specification min., 175°C
DZ	DZ							Z	Zinc-Nickel Plated	TBD Zinc-Nickel Alternative to Cadmium, corrosion resistant, 500 hour salt spray, Conductive, -65°C to +175°C, EMI Shielding -50 dB @ 10 GHz specification min.

* Consult Amphenol Aerospace for availability. **Coaxial arrangements are not available in these classes.

Quadrax or Differential Twinax:

The incorporation of Quadrax or Differential Twinax contacts requires a modified connector to accommodate keyed contacts.

* D38999/26KJ20PN, is a series III stainless steel plug with twin axial and coaxial contacts that may not meet the firewall requirement of the specification. D38999/26KJ61HN, is a series III stainless steel plug with high durability contacts. However, the connector will be limited to 500 cycles of durability. Insert arrangements using multi-axial (i.e. coax, twinax, triax shielded) contacts should not be used in firewall applications.

Step 4. Select a Shell Size & Insert Arrangement see pages 6-9

Double Start Threads	Triple Start Threads										Mil Shell Size Amphenol Shell size
	A	B	C	D	E	F	G	H	J		
7	7H	9	11	13	15	17	19	21	23	25	

1. Connector Type	2. Shell Style	3. Service Class	4. Shell Size-Insert Arrg. 23-2	5. Contact Type	6. Alternate Position	7. Special Variations
-------------------	----------------	------------------	---	-----------------	-----------------------	-----------------------

Shell Size & Insert Arrangement are on pages 6-9. First number represents Shell Size, second number is the Insert Arrangement.

* Size 7 and 7H are Double Start Threads only

Step 5. Select a Contact Type

	Designates
P	Pin Contacts
S	Socket Contacts
H	1500 Cycle Pin Contacts
J	1500 Cycle Socket Contacts
A	Same as "P" except supplied less pin Contacts
B	Same as "S" except supplied less socket contacts (A & B designate nonstandard contact applications)
X	Eyelet contacts, hermetics only

Step 6. Select an Alternate Keying Position

Key/Keyway Position

Shell Size	Key & Keyway Arrangement Identification Letter	AR° or AP° BSC	BR° or BP° BSC	CR° or CP° BSC	DR° or DP° BSC
7, 7H	N*	120	240		
	A	132	248		
	B	80	230	NA	NA
	C	140	275		
	D	155	234		
9	N*	105	140	215	265
	A	102	132	248	320
	B	80	118	230	312
	C	35	140	205	275
	D	64	155	234	304
11, 13, and 15	N*	95	141	208	236
	A	113	156	182	292
	B	90	145	195	252
	C	53	156	220	255
	D	119	146	176	298
17 and 19	N*	80	142	196	293
	A	135	170	200	310
	B	49	169	200	244
	C	66	140	200	257
	D	62	145	180	280
21, 23, and 25	N*	80	142	196	293
	A	135	170	200	310
	B	49	169	200	244
	C	66	140	200	257
	D	62	145	180	280
25L, 33, and 37	N*	80	142	188	293
	A	135	170	188	310
	B	49	169	188	244
	C	66	140	188	257
	D	62	145	188	280
	E	79	153	197	272

* An "N" designation is used on D38999 military part number but not on the commercial versions

Step 7. Special Variations

Consult Amphenol Aerospace for variations.

1.	2.	3.	4.	5.	6.	7.
Connector Type	Shell Style	Service Class	Shell Size-Insert Arr.	Contact Type	Alternate Position	Special Variations
				P	B	

A plug with a given rotation letter will mate with a receptacle with the same rotation letter. The angles for a given connector are the same whether it contains pins or sockets. Master key stays fixed, minor keys rotate. Inserts are not rotated in conjunction with the master key/keyway.

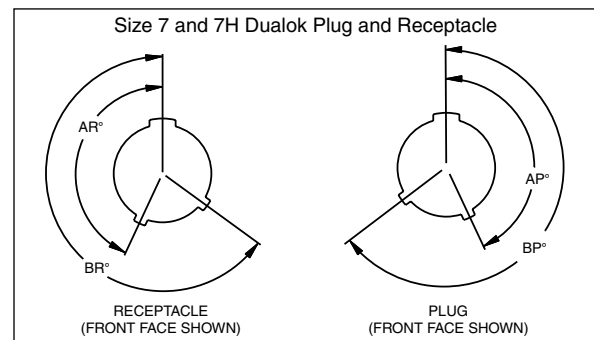
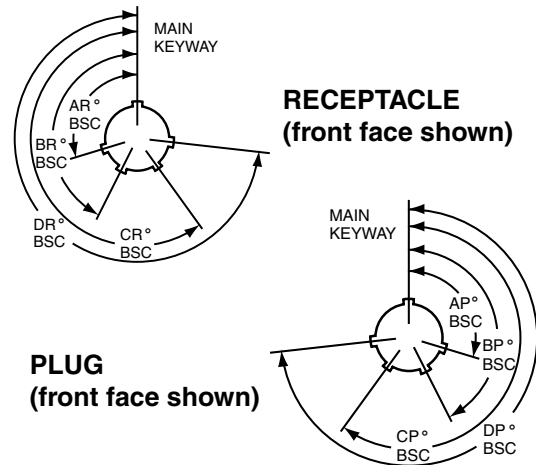

1.	2.	3.	4.	5.	6.	7.
Connector Type	Shell Style	Service Class	Shell Size-Insert Arr.	Contact Type	Alternate Position	Special Variations
						(xxx)

38999

- III
- HD
- Dualok
- II
- I
- SJT
- Accessories
- Aquacon
- Herm/Seal
- PCB

- HIGH SPEED
- Fiber Optics
- Contacts
- Connectors
- Cables

EMI Filter
Transient

26482
Matrix 2

83723 III
Matrix | Pyle

26500
Pyle

5015
Crmp Rear Release Matrix

22992
Class 1

Back-Shell's

Options
Others

38999

Easy Steps to build a part number... Boeing BACC63 CT & CU

1. 2. 3. 4. 5. 6. 7. 8.

Boeing Basic Number	Style	Shell Size	Shell Finish & Contact	Insert Arrangement	Contact Type	Alternate Keying Position	Ordering Option
BACC63	CT	15	—	19	P	N	H

Composite

Step 1. Boeing Number BACC63

Step 2. Select a Style

	Designates
CT	Composite Plug
CU	Composite Receptacle

Step 3. Shell Size 15

	Designates
15	One Shell Size

Step 4. Select a Shell Finish & Contact

	Designates
C	CT Style Only. Cadmium Plated, Grounded
D	Cadmium Plated, ungrounded
G	Nickel Plated, Grounded
—	Nickel Plated, Ungrounded

Step 5. Insert Arrangements-
Consult Amphenol Aerospace for insert arrangements available.

Step 6. Select a Contact Type

	Designates
P	Pin
S	Socket

Step 7. Select an Alternate Keying Position

	Designates
N	Normal
A-E	Alternates

Step 8. Ordering Option

	Designates
H	Without Contacts & Seal Plugs
Blank	With Contacts & Seal Plugs

Easy Steps to build a part number... Boeing BACC63 DB & DC

1. 2. 3. 4. 5. 6. 7. 8.

Boeing Basic Number	Style	Shell Size	Separator	Insert Arrangement	Contact Type	Alternate Keying Position	Ordering Option
BACC63	DB	15	—	19	P	N	H
BACC63	DC	17	—	8	P	N	H

Stainless Steel

Step 1. Boeing Number BACC63

Step 2. Select a Style

	Designates
DB	Stainless Steel Plug
DC	Stainless Steel Receptacle

Step 3. Select a Shell Size

	Designates
9-25	Shell Size

Step 4. Separator

	Designates
—	Separator

Step 5. Insert Arrangements-
Consult Amphenol Aerospace for insert arrangements available.

Step 7. Select an Alternate Keying Position

	Designates
N	Normal
A-E	Alternates

Step 8. Ordering Option

	Designates
H	Without Contacts & Seal Plugs
Blank	With Contacts & Seal Plugs

Step 6. Select a Contact Type

	Designates
P	Pin
S	Socket

TVP00R (D38999/20) - Crimp, Metal CTVP00R (D38999/20) - Crimp, Composite

Wall Mounting Receptacle

PART

To complete, see how to order pages 25-27.

Connector Type	Shell Style	Service Class	Shell Size & Insert Arr	Contact Type	Alternate Position	Special Variations
TVP	00	RW	9-35	P	B	(453)
TVPS	00	RK	X-X	X	X	(XXX)
TVPS	00	RF	X-X	X	X	(XXX)
TVPS	00	RS	X-X	X	X	(XXX)
CTVP	00	RW	X-X	X	X	(XXX)
CTVPS	00	RF	X-X	X	X	(XXX)
D38999/	20	X	X-X	X	X	NA



VIEW D FOR SIZE 8 COAXIAL ONLY, RELATIVE TO -A-

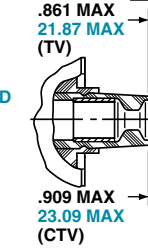

PANEL HOLE DIMENSIONS

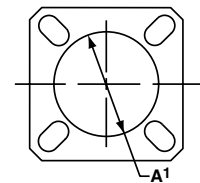

BACK PANEL MOUNTING

VIEW D FOR SIZE 8 TWINAX ONLY, RELATIVE TO -A-

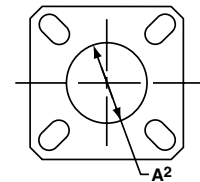
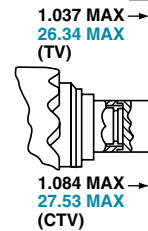

FRONT PANEL MOUNTING

† Red band indicates fully mated

†† Blue band indicates rear release contact retention system

Shell Size	MS Shell Size Code	B Thread Class 2A 0.1P=0.3L-TS (Plated)	L Max. (TV)	L' Max. (CTV)	M +.000 - .005 (TV)	M' +.000 - .005 (CTV)	R ¹	R ²	S Max.	T ±.008	Z Max. (TV)	Z' Max. (CTV)	A ¹ Back Panel Mount	A ² Front Panel Mount	AA Max. Panel Thickness	LL +.006 - .000 (TV)	LL1 ±.005 (CTV)	TT ±.008
9	A	.6250	.469	.514	.820	.773	.719	.594	.948	.128	.153	.198	.650	.510	.234	.905	.908	.216
11	B	.7500	.469	.514	.820	.773	.812	.719	1.043	.128	.153	.198	.800	.620	.234	.905	.908	.194
13	C	.8750	.469	.514	.820	.773	.906	.812	1.137	.128	.153	.198	.910	.740	.234	.905	.908	.194
15	D	1.0000	.469	.514	.820	.773	.969	.906	1.232	.128	.153	.198	1.040	.900	.234	.905	.908	.173
17	E	1.1875	.469	.514	.820	.773	1.062	.969	1.323	.128	.153	.198	1.210	1.010	.234	.905	.908	.194
19	F	1.2500	.469	.514	.820	.773	1.156	1.062	1.449	.128	.153	.198	1.280	1.130	.234	.905	.908	.194
21	G	1.3750	.500	.545	.790	.741	1.250	1.156	1.575	.128	.183	.228	1.410	1.250	.204	.905	.904	.194
23	H	1.5000	.500	.545	.790	.741	1.375	1.250	1.701	.154	.183	.228	1.530	1.360	.204	.905	.904	.242
25	J	1.6250	.500	.545	.790	.741	1.500	1.375	1.823	.154	.183	.228	1.660	1.470	.204	.905	.904	.242

Inches

Shell Size	MS Shell Size Code	L Max. (TV)	L' Max. (CTV)	M +.00 - .13 (TV)	M' +.00 - .13 (CTV)	R ¹	R ²	S Max.	T ±.20	V Thread Metric	Z Max. (TV)	Z' Max. (CTV)	A ¹ Back Panel Mount	A ² Front Panel Mount	AA Max.	LL +.15 - .00 (TV)	LL1 ±.13 (CTV)	TT ±.20
9	A	11.91	13.06	20.83	19.63	18.26	15.09	24.1	3.25	M12X1-6g	3.89	5.03	16.66	13.11	5.94	22.99	23.06	5.49
11	B	11.91	13.06	20.83	19.63	20.62	18.26	26.5	3.25	M15X1-6g	3.89	5.03	20.22	15.88	5.94	22.99	23.06	4.93
13	C	11.91	13.06	20.83	19.63	23.01	20.62	28.9	3.25	M18X1-6g	3.89	5.03	23.42	19.05	5.94	22.99	23.06	4.93
15	D	11.91	13.06	20.83	19.63	24.61	23.01	31.3	3.25	M22X1-6g	3.89	5.03	26.59	23.01	5.94	22.99	23.06	4.39
17	E	11.91	13.06	20.83	19.63	26.97	24.61	33.7	3.25	M25X1-6g	3.89	5.03	30.96	25.81	5.94	22.99	23.06	4.93
19	F	11.91	13.06	20.83	19.63	29.36	26.97	36.9	3.25	M28X1-6g	3.89	5.03	32.94	28.98	5.94	22.99	23.06	4.93
21	G	12.70	13.84	20.07	18.82	31.75	29.36	40.1	3.25	M31X1-6g	4.65	5.79	36.12	32.16	5.18	22.99	22.96	4.93
23	H	12.70	13.84	20.07	18.82	34.93	31.75	43.3	3.91	M34X1-6g	4.65	5.79	39.29	34.93	5.18	22.99	22.96	6.15
25	J	12.70	13.84	20.07	18.82	38.10	34.93	46.4	3.91	M37X1-6g	4.65	5.79	42.47	37.69	5.18	22.99	22.96	6.15

Millimeters

All dimensions for reference only

Designates true position dimensioning

38999

- III
- HD
- Dualok
- II
- I
- SJT
- Accessories
- Aquacon
- Herm/Seal
- PCB

- HIGH SPEED
- Fiber Optics
- Contacts Connectors Cables

- EMI Filter Transient
- Matrix 2
- 26482
- 83723 III

- Matrix 1 Pyle
- 26500
- Pyle

- 5015
- Crimp Rear Release Matrix

- 22992
- Class 1

- Back-Shell's

- Options Others

Box Mounting Receptacle

38999

- III
- HD
- Dualok
- II
- I
- SJT
- Accessories
- Aquacon
- Herm/Seal
- PCB

- HIGH SPEED
- Fiber Optics
- Contacts
- Connectors
- Cables

- EMI Filter
- Transient

- 26482
- Matrix 2

- 83723 III
- Matrix (Pyle)

- 26500
- Pyle

- 5015
- Crimp Rear Release Matrix

- 22992
- Class I

- Back-Shells

- Options
- Others

PART

To complete, see how to order pages 25-27.

Connector Type	Shell Style	Service Class	Shell Size & Insert Arrg	Contact Type	Alternate Position	Special Variations
TVP	02	RW	9-35	P	B	(453)
TVPS	02	RK	X-X	X	X	(XXX)
TVPS	02	RF	X-X	X	X	(XXX)
TVPS	02	RS	X-X	X	X	(XXX)
CTVP	02	RW	X-X	X	X	(XXX)
CTVPS	02	RF	X-X	X	X	(XXX)

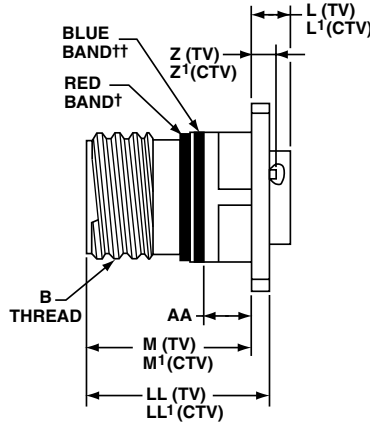
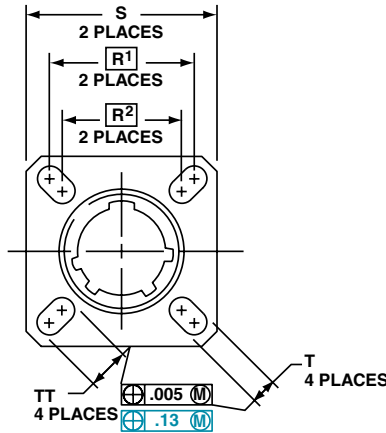

PANEL HOLE DIMENSIONS

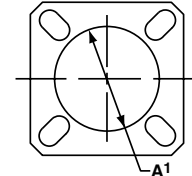

BACK PANEL MOUNTING

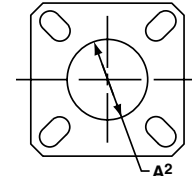

FRONT PANEL MOUNTING

† Red band indicates fully mated

†† Blue band indicates rear release contact retention system

Consult Amphenol Aerospace for availability of composite box mount receptacles.

Inches

Shell Size	MS Shell Size Code	B Thread Class 2A 0.1P=0.3L-TS (Plated)	L Max. (TV)	L' Max. (CTV)	M +.000 - .005 (TV)	M' +.000 - .005 (CTV)	R ¹	R ²	S Max.	T ±.008	Z Max. (TV)	Z' Max. (CTV)	A ¹ Back Panel Mount	A ² Front Panel Mount	AA Max. Panel Thickness	LL +.006 - .000 (TV)	LL1 ±.005 (CTV)	TT ±.008
9	A	.6250	.205	.250	.820	.773	.719	.594	.948	.128	.153	.198	.650	.510	.234	.905	.908	.216
11	B	.7500	.205	.250	.820	.773	.812	.719	1.043	.128	.153	.198	.800	.620	.234	.905	.908	.194
13	C	.8750	.205	.250	.820	.773	.906	.812	1.137	.128	.153	.198	.910	.740	.234	.905	.908	.194
15	D	1.0000	.205	.250	.820	.773	.969	.906	1.232	.128	.153	.198	1.040	.900	.234	.905	.908	.173
17	E	1.1875	.205	.250	.820	.773	1.062	.969	1.323	.128	.153	.198	1.210	1.010	.234	.905	.908	.194
19	F	1.2500	.205	.250	.820	.773	1.156	1.062	1.449	.128	.153	.198	1.280	1.130	.234	.905	.908	.194
21	G	1.3750	.235	.280	.790	.741	1.250	1.156	1.575	.128	.183	.228	1.410	1.250	.204	.905	.904	.194
23	H	1.5000	.235	.280	.790	.741	1.375	1.250	1.701	.154	.183	.228	1.530	1.360	.204	.905	.904	.242
25	J	1.6250	.235	.280	.790	.741	1.500	1.375	1.823	.154	.183	.228	1.660	1.470	.204	.905	.904	.242

Millimeters

Shell Size	MS Shell Size Code	L Max. (TV)	L' Max. (CTV)	M +.00 - .13 (TV)	M' +.00 - .13 (CTV)	R ¹	R ²	S Max.	T ±.20	Z Max. (TV)	Z' Max. (CTV)	A ¹ Back Panel Mount	A ² Front Panel Mount	AA Max.	LL +.15 - .00 (TV)	LL1 ±.13 (CTV)	TT ±.20
9	A	5.21	6.35	20.83	19.63	18.26	15.09	24.1	3.25	3.89	5.03	16.66	13.11	5.94	22.99	23.06	5.49
11	B	5.21	6.35	20.83	19.63	20.62	18.26	26.5	3.25	3.89	5.03	20.22	15.88	5.94	22.99	23.06	4.93
13	C	5.21	6.35	20.83	19.63	23.01	20.62	28.9	3.25	3.89	5.03	23.42	19.05	5.94	22.99	23.06	4.93
15	D	5.21	6.35	20.83	19.63	24.61	23.01	31.3	3.25	3.89	5.03	26.59	23.01	5.94	22.99	23.06	4.39
17	E	5.21	6.35	20.83	19.63	26.97	24.61	33.7	3.25	3.89	5.03	30.96	25.81	5.94	22.99	23.06	4.93
19	F	5.21	6.35	20.83	19.63	29.36	26.97	36.9	3.25	3.89	5.03	32.94	28.98	5.94	22.99	23.06	4.93
21	G	5.97	7.11	20.07	18.82	31.75	29.36	40.1	3.25	4.65	5.79	36.12	32.16	5.18	22.99	22.96	4.93
23	H	5.97	7.11	20.07	18.82	34.92	31.75	43.3	3.91	4.65	5.79	39.29	34.93	5.18	22.99	22.96	6.15
25	J	5.97	7.11	20.07	18.82	38.10	34.92	46.4	3.91	4.65	5.79	42.47	37.69	5.18	22.99	22.96	6.15

All dimensions for reference only

□ Designates true position dimensioning

Straight Plug

PART

To complete, see how to order pages 25-27.

Connector Type	Shell Style	Service Class	Shell Size & Insert Arrg	Contact Type	Alternate Position	Special Variations
TV	06	RW	9-35	P	B	(453)
TVS	06	RK	X-X	X	X	(XXX)
TVS	06	RF	X-X	X	X	(XXX)
TVS	06	RS	X-X	X	X	(XXX)
CTV	06	RW	X-X	X	X	(XXX)
CTVS	06	RF	X-X	X	X	(XXX)
D38999/	26	X	X-X	X	X	NA



† Blue band indicates rear release contact retention system

Inches

Shell Size	MS Shell Size Code	B Thread 0.1P-0.3L-TS-2B (Plated)	Q Dia. Max.
9	A	.6250	.858
11	B	.7500	.984
13	C	.8750	1.157
15	D	1.0000	1.280
17	E	1.1875	1.406
19	F	1.2500	1.516
21	G	1.3750	1.642
23	H	1.5000	1.768
25	J	1.6250	1.890

All dimensions for reference only.

Millimeters

Shell Size	MS Shell Size Code	Q Max.	V Thread Metric
9	A	21.8	M12X1-6g
11	B	25.0	M15X1-6g
13	C	29.4	M18X1-6g
15	D	32.5	M22X1-6g
17	E	35.7	M25X1-6g
19	F	38.5	M28X1-6g
21	G	41.7	M31X1-6g
23	H	44.9	M34X1-6g
25	J	48.0	M37X1-6g

38999

III
HD
Dualok
II
I
SJT
Accessories
Aquacon
Herm/Seal
PCB

HIGH SPEED
Fiber Optics
Contacts
Connectors
Cables

EMI Filter
Transient

26482
Matrix 2

83723 III
Matrix | Pyle

26500
Pyle

5015
Crimp Rear
Release
Matrix

22992
Class 1

Back-Shell's

Options
Others

38999

PART

To complete, see how to order pages 25-27.

Connector Type	Shell Style	Service Class	Shell Size & Insert Arrg	Contact Type	Alternate Position	Special Variations
TV	26	RK	9-35	P	N	(453)
TV	26	RS	X-X	X	N	(XXX)
MTV	26	RK	X-X	X	N	(XXX)
MTV	26	RS	X-X	X	N	(XXX)

For parts with MS Stamping use MTV26() part number as shown above.

Designed for high vibration and harsh environments such as aircraft gas turbine engines, the CLUTCH-LOK is also an ideal choice for demanding applications such as aircraft, space and military ground vehicles. The unique clutch design of the Amphenol CLUTCH-LOK means that you don't have to compromise the need for quick, smooth mating of plugs and receptacles in order to get increased uncoupling torque.

The CLUTCH-LOK has proven to not only remain mated and pass all the Series III specification requirements, it also has proven to actually tighten itself under vibration. This is a powerful advantage over the traditionally high vibration application connectors. The CLUTCH-LOK is also a tremendous advantage in inaccessible, hard to reach areas where mating torque is difficult to apply and complete coupling is not verifiable by inspection.

CLUTCH-LOK features and benefits:

- High degree of differential torque
- Infinite free coupling and positive metal-to-metal bottoming with each mating
- No settling back to the next ratchet tooth
- Available with stainless steel shells and Class K firewall inserts
- All the advantages of MIL-DTL-38999 Series III including EMI/RFI shielding, electrolytic erosion resistance and contact protection with recessed pins
- Enhanced connector performance at affordable prices
- Completely intermateable with all existing MIL-DTL-38999 Series III connectors
- Fully QPL'd

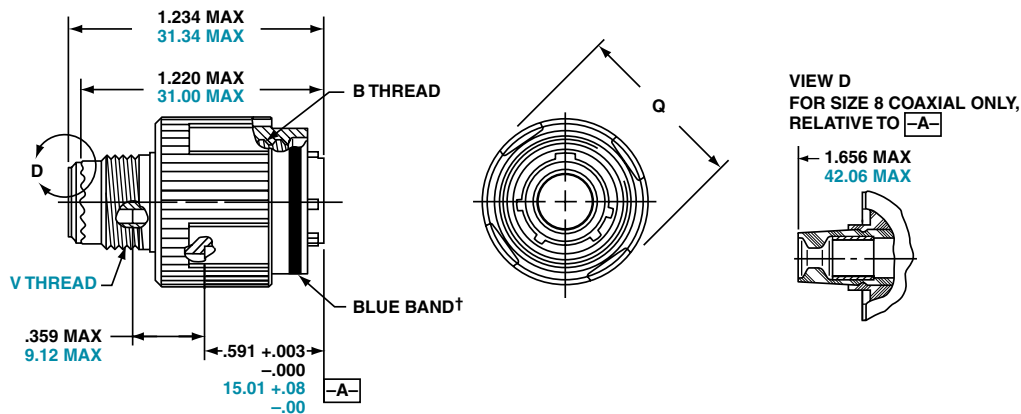

† Blue band indicates rear release contact retention system

Inches

Shell Size	MS Shell Size Code	B Thread 0.1P-0.3L-TS-2B (Plated)	Q Dia. Max.
9	A	.6250	.858
11	B	.7500	.984
13	C	.8750	1.157
15	D	1.0000	1.280
17	E	1.1875	1.406
19	F	1.2500	1.516
21	G	1.3750	1.642
23	H	1.5000	1.768
25	J	1.6250	1.890

Millimeters

Shell Size	MS Shell Size Code	Q Max.	V Thread Metric
9	A	21.8	M12X1-6g
11	B	25.0	M15X1-6g
13	C	29.4	M18X1-6g
15	D	32.5	M22X1-6g
17	E	35.7	M25X1-6g
19	F	38.5	M28X1-6g
21	G	41.7	M31X1-6g
23	H	44.9	M34X1-6g
25	J	48.0	M37X1-6g

All dimensions for reference only.

HIGH SPEED
Fiber Optics
Contacts Connectors Cables
EMI Filter Transient
26482 Matrix 2
83723 III Matrix (Pyle)
26500 Pyle
5015 Crimp Rear Release Matrix
22992 Class L
Back-Shells
Options Others

TV07R (D38999/24) – Crimp, Metal CTV07R (D38999/24) – Crimp, Composite

Jam Nut Receptacle

PART

To complete, see how to order pages 25-27.

Connector Type	Shell Style	Service Class	Shell Size & Insert Arr	Contact Type	Alternate Position	Special Variations
TV	07	RW	9-35	P	B	(453)
TVS	07	RK	X-X	X	X	(XXX)
TVS	07	RF	X-X	X	X	(XXX)
TVS	07	RS	X-X	X	X	(XXX)
CTV	07	RW	X-X	X	X	(XXX)
CTVS	07	RF	X-X	X	X	(XXX)
D38999/	24	X	X-X	X	X	NA

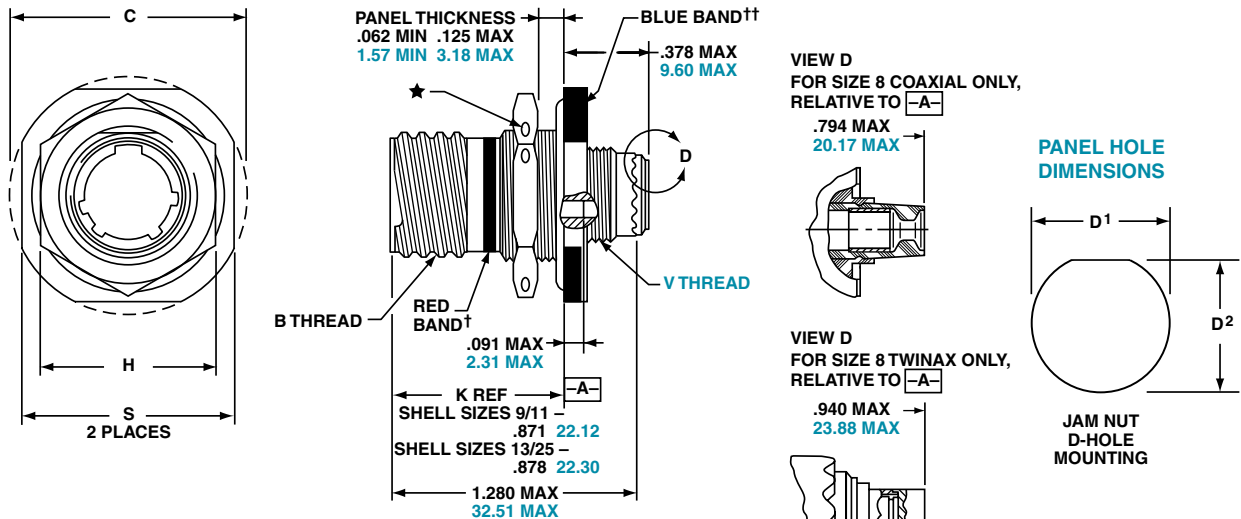

† Red band indicates fully mated

†† Blue band indicates rear release contact retention system

★ .059 dia min.

1.5 dia min., 3 lockwire holes Formed lockwire hole design (6 holes) is optional Inches

Shell Size	MS Shell Size Code	B Thread Class 2A 0.1P-0.3L-TS (Plated)	C Max.	D ¹ +.010 -0.000	D ² +.000 -0.010	H Hex +.017 -0.016	S ±.010
9	A	.6250	1.199	.693	.657	.875	1.062
11	B	.7500	1.386	.825	.770	1.000	1.250
13	C	.8750	1.511	1.010	.955	1.188	1.375
15	D	1.0000	1.636	1.135	1.085	1.312	1.500
17	E	1.1875	1.761	1.260	1.210	1.438	1.625
19	F	1.2500	1.949	1.385	1.335	1.562	1.812
21	G	1.3750	2.073	1.510	1.460	1.688	1.938
23	H	1.5000	2.199	1.635	1.585	1.812	2.062
25	J	1.6250	2.323	1.760	1.710	2.000	2.188

Millimeters

Shell Size	MS Shell Size Code	C Max.	D ¹ +.25 -0.00	D ² +.00 -0.25	H Hex +.43 -0.41	S ±.25	V Thread Metric
9	A	30.45	17.60	16.70	22.23	26.97	M12X1-6g
11	B	35.20	20.96	19.59	25.40	31.75	M15X1-6g
13	C	38.38	25.65	24.26	30.18	34.93	M18X1-6g
15	D	41.55	28.83	27.56	33.32	38.10	M22X1-6g
17	E	44.73	32.01	30.73	36.53	41.28	M25X1-6g
19	F	49.50	35.18	33.91	39.67	46.02	M28X1-6g
21	G	52.65	38.35	37.08	42.80	49.23	M31X1-6g
23	H	55.85	41.53	40.26	46.02	52.37	M34X1-6g
25	J	59.00	44.70	43.43	50.80	55.58	M37X1-6g

All dimensions for reference only NOTE: Deep reach receptacles are available for panel thicknesses up to .750 max.

38999

- III
- HD
- Dualok
- II
- I
- SJT
- Accessories
- Aquacon
- Herm/Seal
- PCB

- HIGH SPEED
- Fiber Optics
- Contacts Connectors Cables

- EMI Filter
- Transient

- 26482
- Matrix 2

- 83723 III
- Matrix | Pyle

- 26500
- Pyle

- 5015
- Crimp Rear Release Matrix

- 22992
- Class 1

- Back-Shell's

- Options
- Others

Line Receptacle

PART

To complete, see how to order pages 25-27.

Connector Type	Shell Style	Service Class	Shell Size & Insert Arrg	Contact Type	Alternate Position	Special Variations
TV	01	RW	9-35	P	B	(453)
TVS	01	RF	X-X	X	X	(XXX)
CTV	01	RW	X-X	X	X	(XXX)
CTVS	01	RF	X-X	X	X	(XXX)

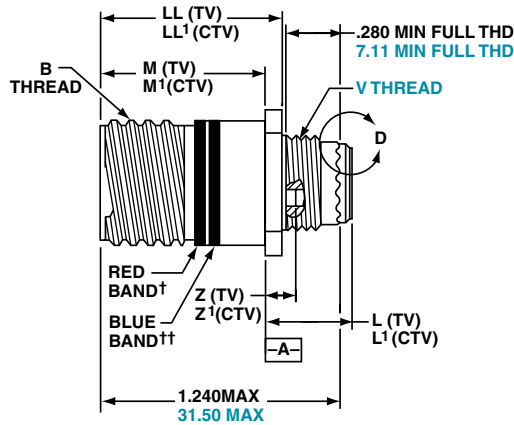
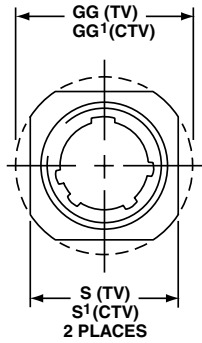

VIEW D
FOR SIZE 8 COAXIAL ONLY,
RELATIVE TO -A-

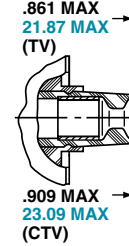

VIEW D
FOR SIZE 8 TWINAX ONLY,
RELATIVE TO -A-

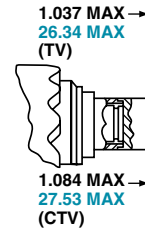

† Red band indicates fully mated

†† Blue band indicates rear release contact retention system

Inches

Shell Size	MS Shell Size Code	B Thread 0.1P-0.3L-TS-2A (Plated)	M +.000 - .005 (TV)	M' +.000 - .005 (CTV)	L Max. (TV)	L' Max. (CTV)	S ±.010 (TV)	S' ±.010 (CTV)	Z Max (TV)	Z' Max (CTV)	GG ±.010 (TV)	GG' ±.010 (CTV)	LL +.006 - .000 (TV)	LL' ±.005 (CTV)
9	A	.6250	.820	.773	.469	.514	.675	.635	.153	.198	.812	.699	.905	.908
11	B	.7500	.820	.773	.469	.514	.800	.765	.153	.198	.905	.875	.905	.908
13	C	.8750	.820	.773	.469	.514	.925	.885	.153	.198	1.093	1.007	.905	.908
15	D	1.0000	.820	.773	.469	.514	1.050	1.100	.153	.198	1.219	1.140	.905	.908
17	E	1.1875	.820	.773	.469	.514	1.238	1.197	.153	.198	1.375	1.229	.905	.908
19	F	1.2500	.820	.773	.469	.514	1.300	1.260	.153	.198	1.469	1.380	.905	.908
21	G	1.3750	.790	.741	.500	.545	1.425	1.385	.183	.228	1.625	1.493	.905	.904
23	H	1.5000	.790	.741	.500	.545	1.550	1.510	.183	.228	1.750	1.626	.905	.904
25	J	1.6250	.790	.741	.500	.545	1.675	1.635	.183	.228	1.875	1.777	.905	.904

Millimeters

Shell Size	MS Shell Size Code	M +.00 - .013 (TV)	M' +.00 - .13 (CTV)	L Max. (TV)	L' Max. (CTV)	S ±.25 (TV)	S' ±.010 (CTV)	V Thread Metric	Z Max (TV)	Z' Max (CTV)	GG ±.25 (TV)	GG' ±.25 (CTV)	LL +.15 - .00 (TV)	LL' ±.13 (CTV)
9	A	20.83	19.63	11.91	13.06	17.15	16.13	M12X1-6g	3.89	5.03	20.62	17.75	22.99	23.06
11	B	20.83	19.63	11.91	13.06	20.32	19.43	M15X1-6g	3.89	5.03	22.99	22.22	22.99	23.06
13	C	20.83	19.63	11.91	13.06	23.50	22.47	M18X1-6g	3.89	5.03	27.76	25.57	22.99	23.06
15	D	20.83	19.63	11.91	13.06	26.67	27.94	M22X1-6g	3.89	5.03	30.96	28.95	22.99	23.06
17	E	20.83	19.63	11.91	13.06	31.45	30.40	M25X1-6g	3.89	5.03	34.93	31.21	22.99	23.06
19	F	20.83	19.63	11.91	13.06	33.02	32.00	M28X1-6g	3.89	5.03	37.31	35.05	22.99	23.06
21	G	20.07	18.82	12.70	13.84	36.20	35.18	M31X1-6g	4.65	5.79	41.28	37.92	22.99	22.96
23	H	20.07	18.82	12.70	13.84	39.37	38.35	M34X1-6g	4.65	5.79	44.45	41.30	22.99	22.96
25	J	20.07	18.82	12.70	13.84	42.55	41.53	M37X1-6g	4.65	5.79	47.63	45.13	22.99	22.96

All dimensions for reference only

- 38999
- III
- HD
- Dualok
- II
- I
- SJT
- Accessories
- Aquacon
- Herm/Seal
- PCB

- HIGH SPEED
- Fiber Optics
- Contacts Connectors Cables

- EMI Filter Transient

- 26482 Matrix 2

- 83723 III Matrix (Pyle)

- 26500 Pyle

- 5015 Crimp Rear Release Matrix

- 22992 Class I

- Back-Shells

- Options Others

TV09R – Crimp, Metal Flange Mounting Plug

PART

To complete, see how to order pages 25-27.

Connector Type	Shell Style	Service Class	Shell Size & Insert Arrg	Contact Type	Alternate Position	Special Variations
TV	09	RW	9-35	P	B	(453)
TVS	09	RF	X-X	X	X	(XXX)

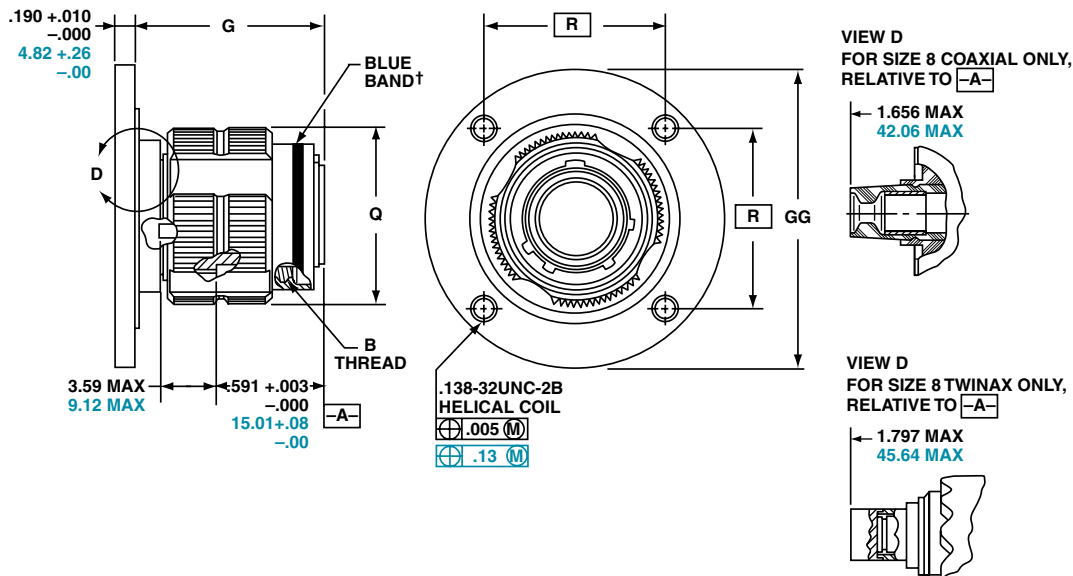

† Blue band indicates rear release contact retention system

Inches

Shell Size	MS Shell Size Coded	B Thread 0.1P-0.3L-TS-2A (Plated)	G $\pm .060$	Q Dia. Max	R	GG Dia $\pm .005$
9**	A	.6250	1.106	.859	1.038	1.838
11	B	.7500	1.106	.969	1.115	1.948
13**	C	.8750	1.106	1.141	1.240	2.124
15	D	1.0000	1.106	1.266	1.327	2.248
17	E	1.1875	1.106	1.391	1.417	2.375
19	F	1.2500	1.356	1.500	1.557	2.495
21	G	1.3750	1.356	1.625	1.624	2.568
23	H	1.5000	1.356	1.750	1.713	2.723
25	J	1.6250	1.356	1.875	1.801	2.848

Millimeters

Shell Size	MS Shell Size Coded	G $\pm .152$	Q Dia. Max	R	GG Dia $\pm .13$
9**	A	28.09	21.82	26.37	46.69
11	B	28.09	24.62	28.32	49.48
13**	C	28.09	28.98	31.50	53.95
15	D	28.09	32.16	33.71	57.10
17	E	28.09	35.33	35.99	60.33
19	F	34.44	38.10	39.55	63.37
21	G	34.44	41.28	41.25	65.23
23	H	34.44	44.45	43.51	69.16
25	J	34.44	47.63	45.75	72.34

All dimensions for reference only

** Partially tooled. Consult Amphenol Aerospace for availability

 Designates true position dimensioning

38999

- III
- HD
- Dualok
- II
- I
- SJT
- Accessories
- Aquacon
- Herm/Seal
- PCB

- HIGH SPEED
- Fiber Optics
- Contacts Connectors Cables

EMI Filter Transient

26482 Matrix 2

83723 III Matrix | Pyle

26500 Pyle

5015 Crimp Rear Release Matrix

22992 Class 1

Back-Shell's

Options Others

38999

PART #

To complete, see how to order pages 25-27.

Connector Type	Shell Style	Service Class	Shell Size & Insert Arrg	Contact Type	Alternate Position	Special Variations
TVPS	02	Y	9-35	P	B	(453)
TVPS	02	YN	X-X	X	X	(XXX)
D38999/	21	X	X-X	X	X	NA



† Red band indicates fully mated

NOTE: Consult Amphenol Aerospace for availability of non-glass-sealed versions with printed circuit tail contacts.

Inches

Shell Size	MS Shell Size Coded	B Thread 0.1P-0.3L-TS (Plated)	R1	R2	S ±.010	T ±.008	TT ±.008
9	A	.6250	.719	.594	.938	.128	.216
11	B	.7500	.812	.719	1.031	.128	.194
13	C	.8750	.906	.812	1.125	.128	.194
15	D	1.0000	.969	.906	1.219	.128	.173
17	E	1.1875	1.062	.969	1.312	.128	.194
19	F	1.2500	1.156	1.062	1.438	.128	.194
21	G	1.3750	1.250	1.156	1.562	.128	.194
23	H	1.5000	1.375	1.250	1.688	.154	.242
25	J	1.6250	1.500	1.375	1.812	.154	.242

Millimeters

Shell Size	MS Shell Size Coded	R1	R2	S ±.25	T ±.20	TT ±.20
9	A	18.26	15.09	23.83	3.25	5.49
11	B	20.62	18.26	26.19	3.25	4.93
13	C	23.01	20.62	28.58	3.25	4.93
15	D	24.61	23.01	30.96	3.25	4.39
17	E	26.97	24.61	33.32	3.25	4.93
19	F	29.36	26.97	36.53	3.25	4.93
21	G	31.75	29.36	39.67	3.25	4.93
23	H	34.93	31.75	42.88	3.91	6.15
25	J	38.10	34.93	46.02	3.91	6.15

All dimensions for reference only

 Designates true position dimensioning

TVS07Y (D38999/23) – Hermetic

Stainless Steel

Jam Nut Receptacle

PART

To complete, see how to order pages 25-27.

Connector Type	Shell Style	Service Class	Shell Size & Insert Arrg	Contact Type	Alternate Position	Special Variations
TVS	07	Y	9-35	P	B	(453)
TVS	07	YN	X-X	X	X	(XXX)
D38999/	23	X	X-X	X	X	NA

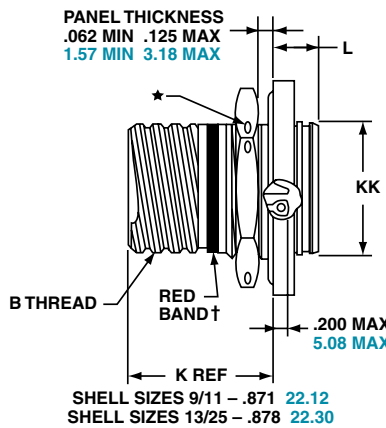
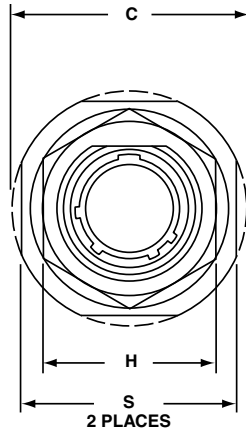

PANEL HOLE DIMENSIONS

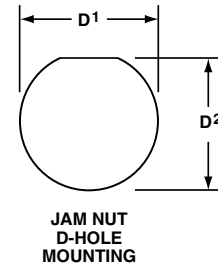

† Red band indicates fully mated

★ .059 dia min.

1.5 dia min. 3 lockwire holes

Formed lockwire hole design (6 holes) is optional.

Inches

Shell Size	MS Shell Size code	B Thread Class 2A 0.1P-0.3L-TS (Plated)	C Max	D ¹ +.010 - .000	D ² +.000 - .010	H Hex +.017 - .016	L Max	S ±.010	KK +.011 - .000
9	A	.6250	1.199	.693	.657	.875	.357	1.062	.642
11	B	.7500	1.386	.825	.770	1.000	.357	1.250	.766
13	C	.8750	1.511	1.010	.955	1.188	.357	1.375	.892
15	D	1.0000	1.636	1.135	1.085	1.312	.357	1.500	1.018
17	E	1.1875	1.761	1.260	1.210	1.438	.357	1.625	1.142
19	F	1.2500	1.949	1.385	1.335	1.562	.381	1.812	1.268
21	G	1.3750	2.073	1.510	1.460	1.688	.381	1.938	1.392
23	H	1.5000	2.199	1.635	1.585	1.812	.381	2.062	1.518
25	J	1.6250	2.323	1.760	1.710	2.000	.381	2.188	1.642

Millimeters

Shell Size	MS Shell Size code	C Max	D ¹ +.25 - .00	D ² +.00 - .25	H Hex +.43 - .41	L Max	S ±.25	KK +.28 - .00
9	A	30.45	17.60	16.70	22.23	9.07	26.97	16.31
11	B	35.20	20.96	19.59	25.40	9.07	31.75	19.46
13	C	38.38	25.65	24.26	30.18	9.07	34.93	22.66
15	D	41.55	28.83	27.56	33.32	9.07	38.10	25.86
17	E	44.73	32.01	30.73	36.53	9.07	41.28	29.01
19	F	49.50	35.18	33.91	39.67	9.68	46.02	32.21
21	G	52.65	38.35	37.08	42.80	9.68	49.23	35.36
23	H	55.85	41.53	40.26	46.02	9.68	52.37	38.56
25	J	59.00	44.70	43.43	50.80	9.68	55.58	41.71

All dimensions for reference only

38999

- III
- HD
- Dualok
- II
- I
- SJT
- Accessories
- Aquacon
- Herm/Seal
- PCB

- HIGH SPEED
- Fiber Optics
- Contacts
- Connectors
- Cables

- EMI Filter
- Transient

- 26482
- Matrix 2

- 83723 III
- Matrix | Pyle

- 26500
- Pyle

- 5015
- Crimp Rear Release Matrix

- 22992
- Class 1

- Back-Shell

- Options
- Others

Solder Mounting Receptacle

38999

- III
- HD
- Dualok
- II
- I
- SJT
- Accessories
- Aquacon
- Herm/Seal
- PCB

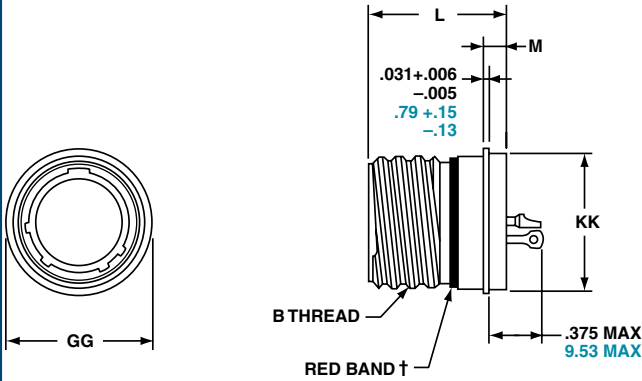

PART #

To complete, see how to order pages 25-27.

Connector Type	Shell Style	Service Class	Shell Size & Insert Arrg	Contact Type	Alternate Position	Special Variations
TVS	I	Y	9-35	P	B	(453)
TVS	I	YN	X-X	X	X	(XXX)
D38999/	25	X	X-X	X	X	NA

† Red band indicates fully mated

Inches

Millimeters

Shell Size	MS Shell Size Code	B Thread Class 2A 0.1P-0.3L-TS (Plated)	L +.011 - .005	M +.006 - .005	GG Dia. +.011 - .010	KK Dia +.011 - .005
9	A	.6250	.806	.125	.750	.672
11	B	.7500	.806	.125	.844	.781
13	C	.8750	.806	.125	.969	.906
15	D	1.0000	.806	.125	1.094	1.031
17	E	1.1875	.806	.125	1.218	1.156
19	F	1.2500	.806	.125	1.312	1.250
21	G	1.3750	.806	.125	1.438	1.375
23	H	1.5000	.838	.156	1.563	1.500
25	J	1.6250	.838	.156	1.688	1.625

Shell Size	MS Shell Size Code	L +.28 - .00	M +.15 - .13	GG Dia. +.28 - .25	KK Dia +.03 - .13
9	A	20.47	3.18	19.05	17.07
11	B	20.47	3.18	21.44	19.84
13	C	20.47	3.18	24.61	23.01
15	D	20.47	3.18	27.79	26.19
17	E	20.47	3.18	30.94	29.36
19	F	20.47	3.18	33.32	31.75
21	G	20.47	3.18	36.53	34.93
23	H	21.29	3.96	39.70	38.10
25	J	21.29	3.96	42.88	41.28

TVSHIY (D38999/27) – Hermetic, Stainless Steel

Weld Mounting Receptacle

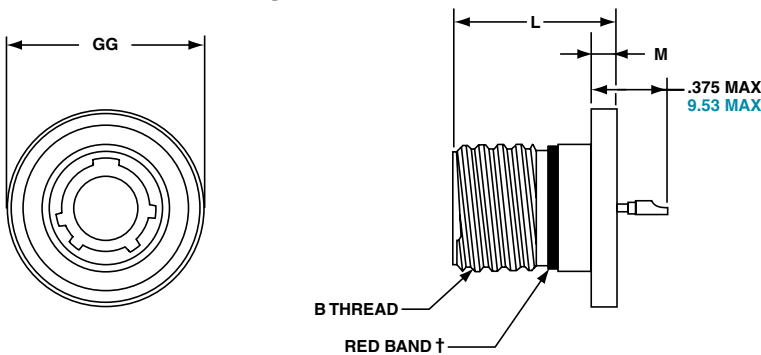

PART #

To complete, see how to order pages 25-27.

Connector Type	Shell Style	Service Class	Shell Size & Insert Arrg	Contact Type	Alternate Position	Special Variations
TVS	HI	Y	9-35	P	B	(453)
TVS	HI	YN	X-X	X	X	(XXX)
D38999/	27	X	X-X	X	X	NA

† Red band indicates fully mated

Inches

Millimeters

Shell Size	MS Shell Size Code	B Thread Class 2A 0.1P-0.3L-TS (Plated)	L +.011 - .000	M +.006 - .005	GG Dia. +.011 - .010
9	A	.6250	.806	.125	.973
11	B	.7500	.806	.125	1.095
13	C	.8750	.806	.125	1.221
15	D	1.0000	.806	.125	1.347
17	E	1.1875	.806	.125	1.434
19	F	1.2500	.806	.125	1.579
21	G	1.3750	.806	.125	1.721
23	H	1.5000	.838	.156	1.886
25	J	1.6250	.838	.156	1.973

Shell Size	MS Shell Size Code	L +.28 - .00	M +.15 - .13	GG Dia. +.25 - .00
9	A	20.47	3.18	24.71
11	B	20.47	3.18	27.81
13	C	20.47	3.18	31.01
15	D	20.47	3.18	34.21
17	E	20.47	3.18	36.42
19	F	20.47	3.18	40.11
21	G	20.47	3.18	43.71
23	H	21.29	3.96	47.90
25	J	21.29	3.96	50.11

All dimensions for reference only

- High Speed
- Fiber Optics
- Contacts Connectors Cables
- EMI Filter Transient
- 26482 Matrix 2
- 83723 III Matrix | Pyle
- 26500 Pyle
- 5015 Crimp Rear Release Matrix
- 22992 Class 1
- Back-Shells
- Options Others

Series III, TV Breakaway Fail Safe Connectors Quick-Disconnect with an Axial Pull of Lanyard

38999

III
HD
Dualok
II
I
SJT
Accessories
Aquacon
Herm/Seal
PCB

HIGH SPEED
Fiber Optics
Contacts Connectors Cables

EMI Filter Transient

26482 Matrix 2

83723 III Matrix Pyle

26500 Pyle

5015 Crimp Rear Release Matrix

22992 Class 1

Back-Shells

Options Others

Amphenol® Tri-Start Breakaway Fail Safe Connectors provide unequalled performance in environments requiring instant disengagement.

Designed to provide quick disconnect of a connector plug and receptacle with an axial pull on the lanyard. The “Breakaway” Fail Safe connector family offers a wide range of electrical and mechanical features:

- Instant decoupling and damage free separation
- Completely intermateable with standard receptacles (D38999/20 and /24)
- Inventory support commonality through the use of standard insert arrangements and contacts

Breakaway unmating is initiated by applying a pull force to the lanyard which causes the operating sleeve on the plug to move away from the receptacle. Coupling segments on the plug then move away from the mating receptacle while expanding, thus releasing the receptacle. After completion of the unmating sequence, spring compression returns the sleeve and segments to their original positions. Unmating of the plug may also be accomplished by normal rotation of the coupling ring without affecting the breakaway capability.



Amphenol offers a variety of lanyard plug styles including MIL-STD-1760 types 1, 2 and 6 for Stores Management applications.

The Tri-Start Breakaway Fail Safe connector exceeds the MIL-Spec Series III requirements for EM/EMP shielding and features include:

- Solid metal-to-metal coupling
- EMI grounding fingers
- Conductive finishes

Amphenol Breakaway Fail Safe connectors are qualified to MIL-DTL-38999/29, /30 and /31 (for MIL-STD-1760 Stores Management applications). In fact, Amphenol offers more qualified Breakaway shell size and insert combinations than any other QPL supplier.

In addition to standard Breakaway connectors, Amphenol also manufactures custom breakaway connectors including those with:

- Highly durable non-metallic operating sleeves in a variety of lengths and diameters
- Increased pull-force capability
- Low-profile designs
- Custom lanyard lengths and backshells
- Low force separation capabilities
- Low insertion/separation force contacts
- Non-cadmium finishes

Whether you need a standard Breakaway, one of our custom Breakaways or a unique Breakaway design, please contact your local Amphenol representative.

Contact Amphenol Aerospace for more information on breakaway, quick-disconnect connectors. Other Amphenol circular families (MIL-DTL-26482, MIL-DTL-83723) also offer breakaway quick-disconnect connectors.

See accessories for breakaway connectors on page 111.

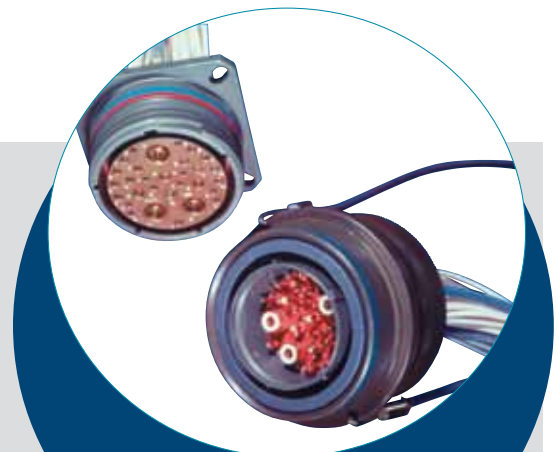

Breakaway with Coax Contacts



Special configuration Fail Safe used on space telescope application.

Lanyard is replaced by a swivel ring for remote disconnect and “wing arms” have been added for manual actuation accessibility by gloved astronauts.

D38999/29 & D38999/30 – Series III TV Breakaway Fail Safe-Crimp, Metal Lanyard Release Plug

38999

- III
- HD
- Dualok
- II
- I
- SJT
- Accessories
- Aquacon
- Herm/Seal
- PCB

- HIGH SPEED
- Fiber Optics
- Contacts Connectors Cables

- EMI Filter Transient

- 26482 Matrix 2

- 83723 III Matrix | Pyle

- 26500 Pyle

- 5015 Crimp Rear Release Matrix

- 22992 Class I

- Back-Shells

- Options Others

PART #	Connector Type	Shell Style	Shell Size & Insert Arrg	Lanyard Length Code	Contact Type/ Alternate Insert Rotation	
To complete, see how to order pages 41-42.	D38999	29	29	E	P	(Pins Only)
	D38999	30	X-X	X	X	(Sockets Only)
	88	5565	X-X	X	X	
	91	5565	X-X	X	X	

METAL

.374 MAX
9.50 MAX
OUTER SLEEVE MOVEMENT
DURING UNMATING THREAD RELEASE

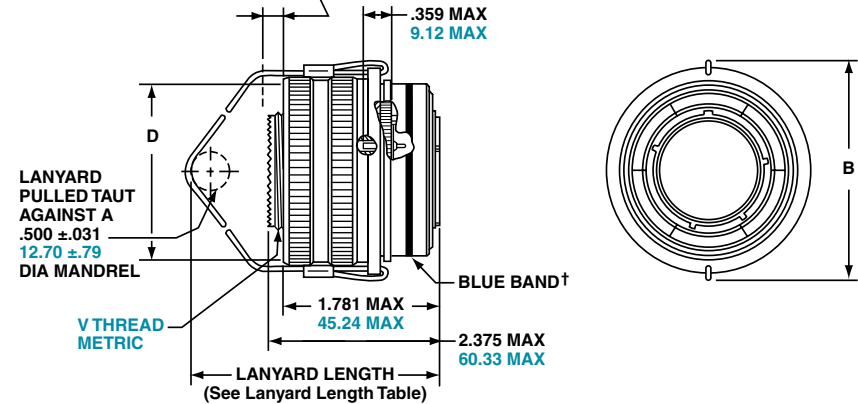

† Blue band indicates rear release contact retention system

Inches

Shell Size	MS Shell Size Code	B Max	D Max Accessory Dia.
11	B	1.846	1.109
13	C	1.972	1.250
15	D	2.079	1.375
17	E	2.205	1.500
19	F	2.301	1.625
21	G	2.472	1.750
23	H	2.594	1.875
25	J	2.705	2.000

Millimeters

Shell Size	MS Shell Size Code	B Max	D Max Accessory Dia.	V Thread Metric
11	B	46.89	28.17	M15X1.0-6g
13	C	50.09	31.75	M18X1.0-6g
15	D	52.81	34.93	M22X1.0-6g
17	E	56.01	38.10	M25X1.0-6g
19	F	58.45	41.28	M28X1.0-6g
21	G	62.79	44.45	M31X1.0-6g
23	H	65.89	47.63	M34X1.0-6g
25	J	68.71	50.08	M37X1.0-6g

All dimensions for reference only

Easy Steps to build a part number... **Military**

1. 2. 3. 4. 5. 6. 7.

DOD Number Prefix	Spec Sheet Number	Service Class	Shell Size	Insert Arrangement	Lanyard Length Code	Alternate Keying Position
D38999/	29	F	E	35	P	N

Step 1. DOD Number Prefix

D38999/ designates MIL-DTL-38999, Series III, Tri-Start Connector

Step 2. Select a Specification Sheet Number

29	Designates Lanyard Release Plug with pin contacts
30	Designates Lanyard Release Plug with socket contacts

Step 4. & 5 Insert Availability

Step 3. Select a Service Class

F	Designates electroless nickel plated aluminum, optimum EMI shielding effectiveness -65dB@10 GHz specification min., 48 hour salt spray, 200°C
W	Designates corrosion resistant olive drab cadmium plate aluminum, 500 hour extended salt spray, EMI -50dB@10 GHz specification min., 175°C

Commercial Basic Part# Shell & Insert Arrg. Code	Shell Size-Insert Arrangement	Military Shell Size-Insert Arrangement	Service Rating	Total Contacts	Contact Size							
					22D	20	16	12	12 Coax	8 Coax	8 Twinax	
88/91-556508	11-2	N/A	I	2			2					
06	11-35	N/A	M	13	13							
07	11-98	N/A	I	6		6						
10	13-4	N/A	I	4			4					
11	13-8	N/A	I	8		8						
14	13-35	N/A	M	22	22							
13	13-98	N/A	I	10		10						
18	15-5	N/A	II	5			5					
23	15-15	N/A	I	15		14	1					
22	15-18	N/A	I	18		18						
19	15-19	N/A	I	19		19						
20	15-35	N/A	M	37	37							
21	15-97	N/A	I	12		8	4					
27	17-6	E-6	I	6				6				
28	17-8	E-8	II	8			8					
29	17-26	E-26	I	26		26						
30	17-35	E-35	M	55	55							
31	17-99	E-99	I	23		21	2					
37	19-11	F-11	II	11			11					
39	19-32	F-32	I	32		32						
40	19-35	F-35	M	66	66							
47	21-11	G-11	I	11				11				
48	21-16	G-16	II	16			16					
49	21-35	G-35	M	79	79							
51	21-39	G-39	I	39		37	2					
50	21-41	G-41	I	41		41						
57	23-21	H-21	II	21			21					
58	23-35	H-35	M	100	100							
59	23-53	H-53	I	53		53						
61	23-54	H-54	M	53	40		9	4				
60	23-55	H-55	I	55		55						
71	25-4	J-4	I	56		48	8					
66	25-19	J-19	I	19				19				
74	25-20	J-20	N	30		10	13		4		3	
72	25-24	J-24	I	24			12	12				
67	25-29	J-29	I	29			29					
68	25-35	J-35	M	128	128							
69	25-43	J-43	I	43		23	20					
73	25-46	J-46	I	46		40	4			2*		
70	25-61	J-61	I	61		61						

- III
- HD
- Dualok
- II
- I
- SJT
- Accessories
- Aquacon
- Herm/Seal
- PCB

- HIGH SPEED
- Fiber Optics
- Contacts Connectors Cables

- EMI Filter
- Transient

- 26482
- Matrix 2

- 83723 III
- Matrix | Pyle

- 26500
- Pyle

- 5015
- Crimp Rear Release Matrix

- 22992
- Class 1

- Back-Shell's

- Options
- Others

38999

- III
- HD
- Dualok
- II
- I
- SJT
- Accessories
- Aquacon
- Herm/Seal
- PCB

HIGH SPEED

- Fiber Optics
- Contacts Connectors Cables

EMI Filter Transient

26482 Matrix 2

83723 III Matrix | Pyle

26500 Pyle

5015 Crimp Rear Release Matrix

22992 Class I

Back-Shells

Options Others

Step 6. Military/ Commercial
Lanyard Length Code

Table II

Lanyard Length (in.) ± .236	Lanyard Length (mm) ± 6.0	Lanyard Length Code For Part Number
4.016	102	A
4.528	115	B
5.000	127	C
5.512	140	D
6.024	153	E
6.535	166	F
7.008	178	G
7.520	191	H
7.992	203	I
8.503	216	J
9.016	229	K
9.528	242	L
10.000	254	M
10.512	267	N
11.024	280	P
11.535	293	R
12.008	305	S
12.520	318	T
13.031	331	U
14.016	356	V
15.000	381	W
16.024	407	X
17.008	432	Y
18.031	458	Z

Step 7. Military Alternate Keying Position
For alternate positions of connector (to prevent cross-mating) see alternate positioning on page 27. (N indicates normal)

Easy Steps to build a part number... Commercial

FAIL SAFE 88-5565() & 91-5565()

Ordering procedure for example part number 88-556529-EP is shown below:

1.	2.	3.	4.	5.	6.
Service Class	Connector Type Identification	Shell Size & Insert Arrg. Code	Required Field	Lanyard Length Code	Contact Type/Alternate Keying Position
88	5565	29	0	E	P

Step 1. Select a Service Class

88	Designates corrosion resistant olive drab cadmium plate over nickel, 500 hour extended salt spray, EMI -50dB @ 10 GHz specification min., 175°C
91	Designates electroless nickel plated aluminum, optimum EMI shielding effectiveness -65dB @ 10 GHz specification min., 48 hour salt spray, 200°C

These are standard finishes. Consult Amphenol Aerospace for other variations.

Step 2. Select a Connector Type Identification

5565	Designates MIL-DTL-38999, Series III Tri-Start Lanyard Release Plug
------	---

Step 3. Select a Commercial Shell Size & Insert Arrangement Code

MIL-DTL-38999, see insert availability chart on page 41.

Step 4. Required Field

0	The required field is always a 0
---	----------------------------------

Step 5. Select a Lanyard Length Code

See Table II (to the left) for lanyard length code number.

Step 6. Select a Contact Type/Alternate Keying Position

P designates pin, S designates socket for normal positioning of contacts. When an alternate position of the connector is required to prevent cross-mating, a different letter (other than P or S) is used. See alternate positioning on page 27, then convert to Amphenol Commercial coding by the following chart.

Pin Contacts		Socket Contacts	
MS Letter	Amphenol letter	MS Letter	Amphenol Letter
PN	P (normal)	SN	S (normal)
PA	G	SA	H
PB	I	SB	J
PC	K	SC	L
PD	M	SD	N
PE	R	SE	T

Lanyard Release Plug

PIN CONTACTS ONLY,
SHELL SIZE 25 ONLY



TYPE 6



TYPE 2



TYPE 1
(LONGER SHELL)

† Blue band indicates rear release contact retention system
** Lanyard pulled taut against a .500 ± .13 dia. Mandrel
All dimensions for reference only

Pin Contact Data for MIL-STD-1760

Insert Arrangement	Service Rating	Total Contacts	Contact			
			20	16	12 (Coax)	8 (Twinax)
25-20	N	30	10	13	4	3

Contacts for 25-20 Pattern

Shell Size	Arrg. Number	Number of Contacts	Size Contacts	Service Rating	Contact Location	Standard Contacts	
						Pin	Socket
25	-20	3	8	Twinax	A, H, K	M39029/90-529	M39029/91-530
		4	12	Coax	2,3	M39029/28-211	M39029/75-416
					W, 5	M39029/102-558	M39029/103-559
		13	16	N	C, D, E, F, J, M, N, P, R, T, U, Y, Z	M39029/58-364	M39029/56-352
10	20	N	B, G, L, S, V, X, 1, 4, 6, 7	M39029/58-363	M39029/56-351		

Insert Arrangement	Service Rating	Total Contacts	Contact Size	
			20	10 (power)
25-11	N	11	2	9

*Part number reference.
To complete, see how to order page 41.

- D38999/31
- 88-555875/76 } Type 6
 - 91-555875/76 }
 - 88-558518/19 } Type 2
 - 91-558518/19 }
 - T3W-16B25-XXXX — Type 1

*To order by Commercial Part numbers consult Amphenol.

Tri-Start Lanyard Separation Forces

Shell Size	Straight Plug (lbs. max.)	15 Degree Pull (lbs. max.)
25	90	100

**INSERT AVAILABILITY
FAIL SAFE D38999/31
FOR MIL-STD-1760**

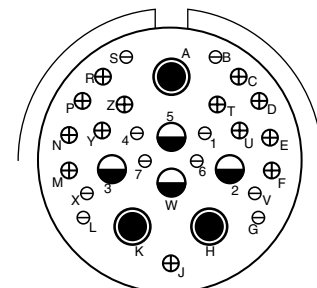

25-20

Primary Interface Signal Set

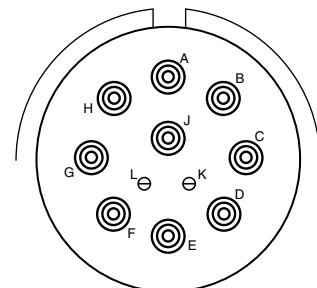

25-11

Auxiliary Power Signal Set

Contact Legend



8 (twinax) 10 (power) 12 (coax) 16 20

38999

III
HD
Dualok
II
I
SJT
Accessories
Aquacon
Herm/Seal
PCB

HIGH SPEED
Fiber Optics
Contacts Connectors Cables

EMI Filter
Transient

26482
Matrix 2

83723 III
Matrix | Pyle

26500
Pyle

5015
Crimp Rear Release Matrix

22992
Class 1

Back-Shell's

Options
Others

- 38999
- III
- HD
- Dualok
- II
- I
- SJT
- Accessories
- Aquacon
- Herm/Seal
- PCB

- HIGH SPEED
- Fiber Optics
- Contacts Connectors Cables

- EMI Filter Transient

- 26482 Matrix 2

- 83723 III Matrix | Pyle

- 26500 Pyle

- 5015 Crimp Rear Release Matrix

- 22992 Class I

- Back-Shells

- Options Others

HOW TO ORDER - BY MILITARY PART NUMBER FAIL SAFE D38999/31

Ordering procedure for example part number D38999/31WE20PN1 is shown below:

Easy Steps to build a part number... Military

1.	2.	3.	4.	5.	6.	7.	8.
DOD Number Prefix	Spec Sheet Number	Service Class	Lanyard Length Code	Insert Arrangement	Contact Style	Alternate Keying Position	Type Number
D38999/	31	W	E	20	P	N	1

1. Select a DOD Number Prefix

	Designates
D38999/	MIL-DTL-38999, Series III Tri-Start Connectors

2. Specification Sheet Number

	Designates
31	Designates Lanyard Release Plug for MIL-STD-1760 with pin contacts

3. Select a Service Class

	Designates
F	Electroless nickel plated aluminum, optimum EMI shielding effectiveness –65dB @ 10 GHz specification min., 48 hour salt spray, 200°C
W	Corrosion resistant olive drab cadmium plate aluminum, 500 hour extended salt spray, EMI –50dB @ 10 GHz specification min., 175°C

4. Select a Lanyard Length Code

Lanyard Length (in.) ±.236	Lanyard Length (mm.) ± 6.0	Lanyard Length Code for Part Number
6.024	153.0	E
6.535	166.0	F
7.008	178.0	G
7.520	191.0	H
7.992	203.0	I
8.504	216.0	J
9.016	229.0	K
9.528	242.0	L

5. Select an Insert Arrangement

Only 11 or 20 are available contact arrangement numbers. See page 43.

6. Contact Style – P & A are Valid Options

	Designates
P	Replaces the “no designation” option in the PIN on revision C and earlier revision of the Mil-Spec.
A	Designates supplied less contacts.

7. Alternate Keying Position

	Designates
N	Is required for normal position.

8. Type Number

Type 1, 2 or 6. See drawings on page 43.

For accessories for lanyard release plugs see Accessories section.

D38999 Type Hybrid Breakaway – Series III

Lower Profile Lanyard Release Plug, Crimp, Metal shells with Composite Operating Sleeve

New Hybrid Lanyard Breakaway Fail Safe connector with a composite thermoplastic outer operating sleeve for greater durability.

This new hybrid breakaway is the breakaway of choice for the Navy F-18 Program. Amphenol's hybrid lanyard design offers greater durability over D38999 aluminum and composite designs because of its ability to handle abuse taken after weapons release.

Other advantages include:

- Lower profile compared to full metal breakaway Fail Safe connectors
- Less weight

This Hybrid Breakaway meets the applicable requirements of MIL-DTL-38999/31 including random & sine vibration, ice resistance, fluid immersion and hydrolytic stability tests. (Test reports are available upon request).

Currently the hybrid breakaway is available in shell sizes 25 and 17. It uses standard inserts available for breakaway plugs sizes 25 and 17, and is also available with inserts 25-20 and 25-11 for MIL-STD-1760. Consult Amphenol Aerospace for ordering of the new hybrid breakaway connectors. These hybrid connectors will accommodate the standard backshells for breakaway connectors shown on Accessories section or the backshell section.



New Hybrid Lanyard Release Plugs (Metal inside shells and Composite, lower profile outer sleeves)

Condition/Test	Description	Reference
Durability	400 complete mating/unmating cycles	MIL-DTL-38999/31D
High Impact Shock	Nine hammer blows from 1,3 and 5 feet, three each in three axes on mounting panel.	MIL-S- 901D
Vibration	10 to 2000Hz in three perpendicular axes, 4 hours in each axis for a total of 12 hours with no fracturing or breaking of parts.	MIL-STD-202F, Method 204
Ice Resistance	Pull tested after conditioned with Ice water at -18C for 35 minutes.	MIL-DTL-38999/31D
Fail Safe Disengagement	Rotationally unmated 180° from full mate position and pull tested in both a straight direction and at 15°.	MIL-DTL-38999/31D
High Speed Pull Separation	100 cycles at 30 feet per second.	MIL-DTL-38999/31D

Stores Management Type II, Rail Launch

Plugs and Receptacles that meet MIL-STD-1760

Amphenol provides a Breakaway Rail Launch connector that is designed for use on aircraft that carry rail launch missiles such as AMRAAM.

These connectors are designed for blindmating of stores on rail launch applications. They consist of a buffer plug and a missile receptacle that meet the specifications of MIL-STD-1760 Stores Management.

Other features and benefits include:

- Designed to MIL-C-83538 specifications
- Bayonet and push pull coupling
- Use standard MIL-DTL-38999 crimp termination with power, coax and twinax contacts also available
- Buffer provides flame barrier
- Buffers are replaceable

Consult Amphenol Aerospace for more information and ordering.



Stores Management Type II Rail Launch Connectors

38999

III

HD

Dualok

II

I

SJT

Accessories

Aquacon

Herm/Seal

PCB

HIGH SPEED

Fiber Optics

Contacts Connectors Cables

EMI Filter Transient

26482 Matrix 2

83723 III Matrix | Pyle

26500 Pyle

5015 Crimp Rear Release Matrix

22992 Class 1

Back-Shell's

Options Others