

1 Features

- Designed for 2.4 GHz applications: Bluetooth®, Wi-Fi® (802.11a/b/g/n), ZigBee®, etc., as well as 2.3 GHz WiMAX™, 2.5 GHz WiMAX™ and WiBro applications.
- Easy to integrate
- High efficiency
- Intended for snap-in mounting
- Supplied in bulk

2 Description

Picea is intended for use with all 2.4 GHz applications and it has an antenna blade made of a flexible material that can be rotated 360 degrees.

The antenna is intended for snap-in mounting and it uses a ground plane in order to radiate efficiently. The ground plane must extend underneath the antenna itself.

3 Applications

- Development tools
- Test equipment
- Access points, routers, etc



4 Part number

Picea: B5771 (PCB thickness = 1.6 mm)

5 General data

Product name	Picea 2.4 GHz
Part Number	B5771
Frequency	2.4 – 2.5 GHz
Polarization	Linear
Operating temperature	-40 °C to +85 °C
Impedance with matching	50 Ω
Weight	3.3 g
Antenna type	Swivel
Dimensions	14.9 x 12 x 48 [mm]

Note: Picea is not intended for outdoor use or applications.

6 Electrical characteristics

	Typical performance	Conditions
Peak gain	2.1 dBi	All data measured on Antenova's reference board, part number B5771-U1 Data given for the 2.4 – 2.5 GHz frequency range
Average gain	-1.5 dBi	
Average efficiency	70%	
Maximum Return Loss	-12 dB	
Maximum VSWR	1.7:1	

7 Electrical performance

7-1 Return Loss

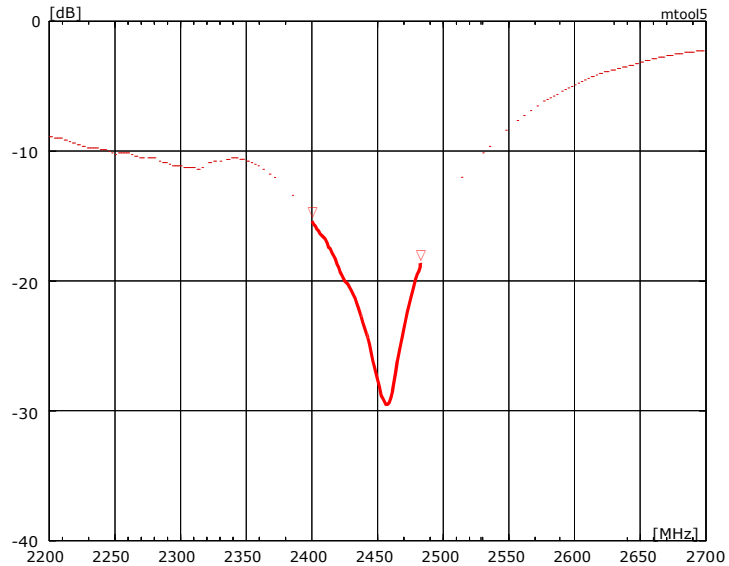

7-2 VSWR

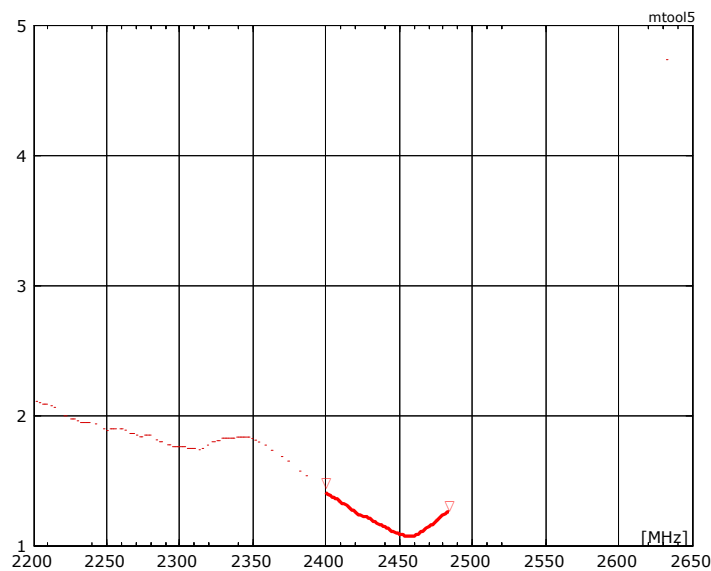

7-3 Antenna patterns

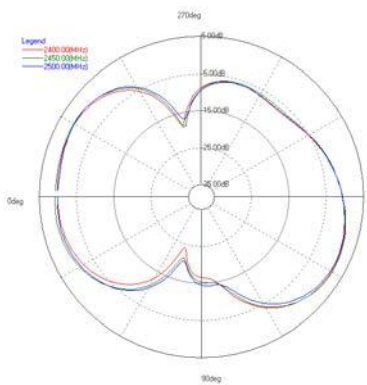
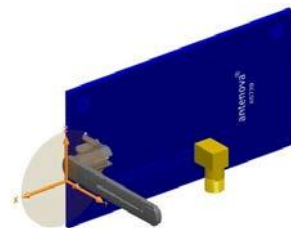
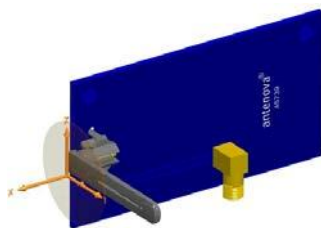
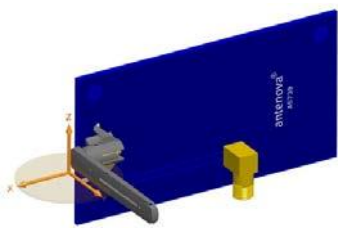
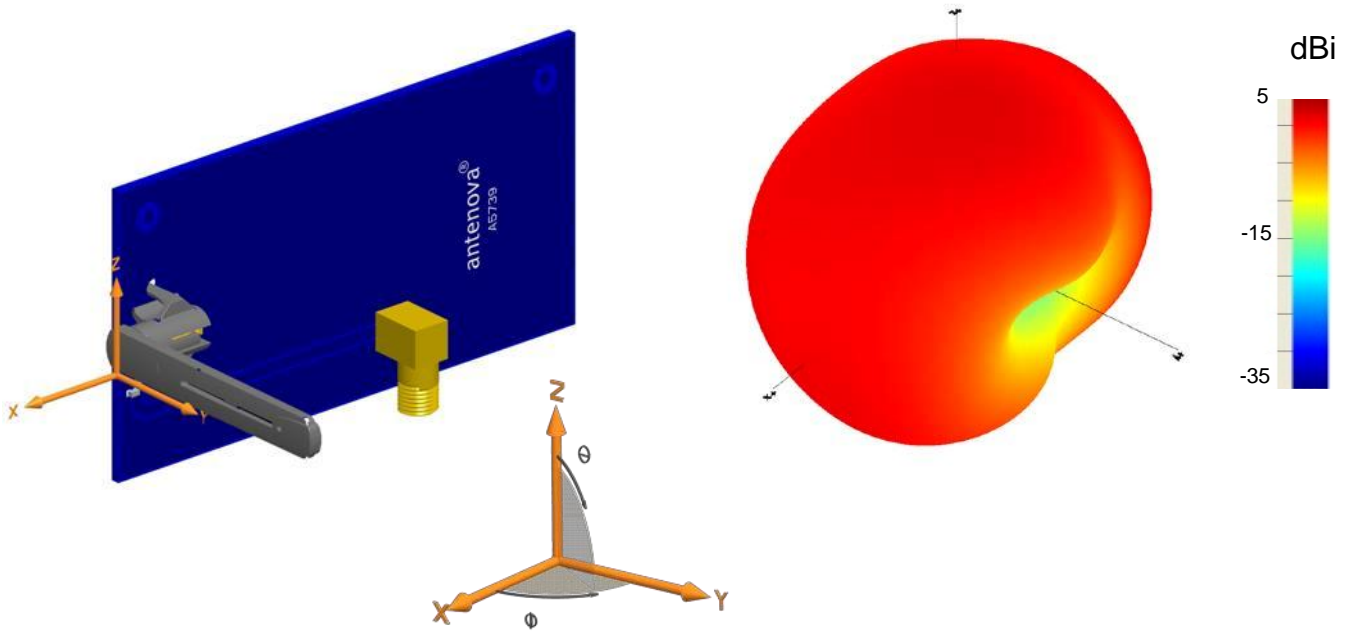

XY plane

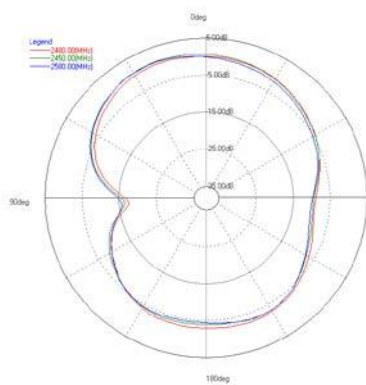

ZY plane

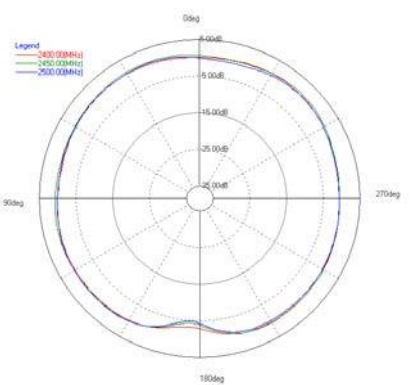

XZ plane

Patterns show combined polarisations
measured on reference board B5771-U1

8 Antenna dimensions

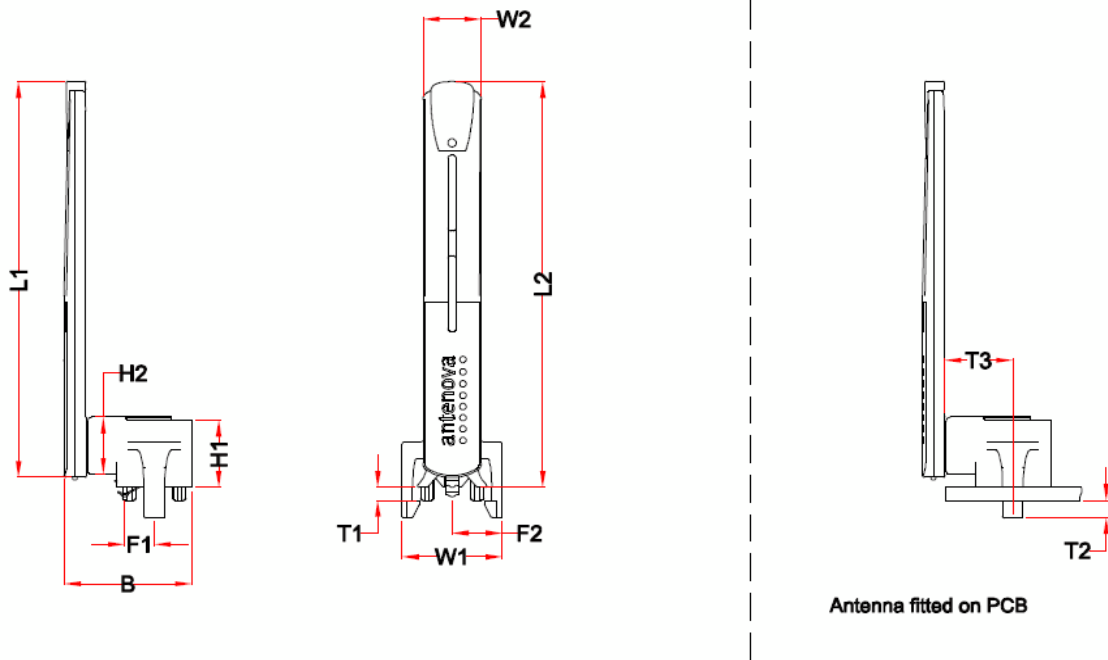

L1	L2	W1	W2	H1	H2	F1	F2	T1	T2	T3	B
Length	Length	Width	Width	Height	Height	Feed	Feed	PCB Thickness			
48.3 ± 0.3	49.5 ± 0.3	12 ± 0.2	7.0 ± 0.2	8.55 ± 0.2	7.1 ± 0.2	3.55 ± 0.2	6 ± 0.2	1.6 ± 0.05	2.1 ± 0.2	8.0 ± 0.2	14.9 ± 0.2

Dimensions in mm

9 Antenna footprint

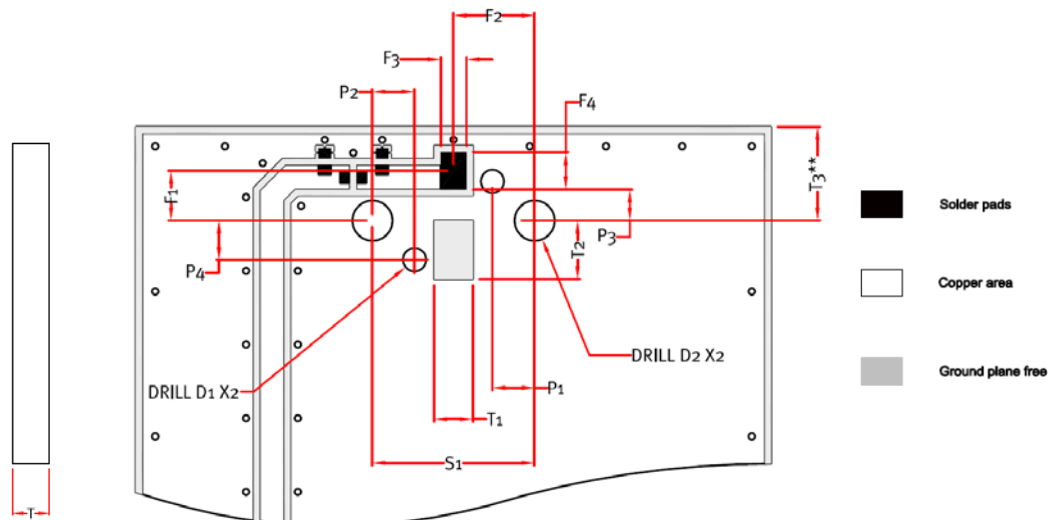

Picea (Part No: B5771)

* CAD files of the antenna footprint are available to download from www.antenova-m2m.com

F1	F2	F3	F4	S1	P1/P2	P3/P4	D1	D2	T	T1	T2	T3
Feed	Feed	Feed	Feed	Snap-in	Position	Position	Diameter	Diameter	PCB Thickn.			
4 ± 0.1	6 ± 0.1	2 ± 0.1	2.25 ± 0.1	12.5 ± 0.1	3.25 ± 0.1	3.0 ± 0.1	1.8 ± 0.1	3.1 ± 0.1	1.6 ± 0.1	3.0 ± 0.1	4.5 ± 0.1	Max 7.2

Dimensions in mm

10 Electrical interface

10-1 Transmission lines

- All transmission lines should be designed to have a characteristic impedance of 50 Ω
- The length of the transmission lines should be kept to a minimum
- Any other parts of the RF system like transceivers, power amplifiers, etc, should also be designed to have an impedance of 50 Ω

Once the material for the PCB has been chosen (PCB thickness and dielectric constant), a coplanar transmission line can easily be designed using any of the commercial software packages for transmission line design. For the chosen PCB thickness, copper thickness and substrate dielectric constant, the program will calculate the appropriate transmission line width and gaps on either side of the track so the characteristic impedance of the coplanar transmission line is 50 Ω .

10-2 Matching circuit

The antenna requires a matching circuit that must be optimized for each customer's product. The matching circuit will require up to three components and the following pad layout should be designed into the device so the correct circuit can be installed:

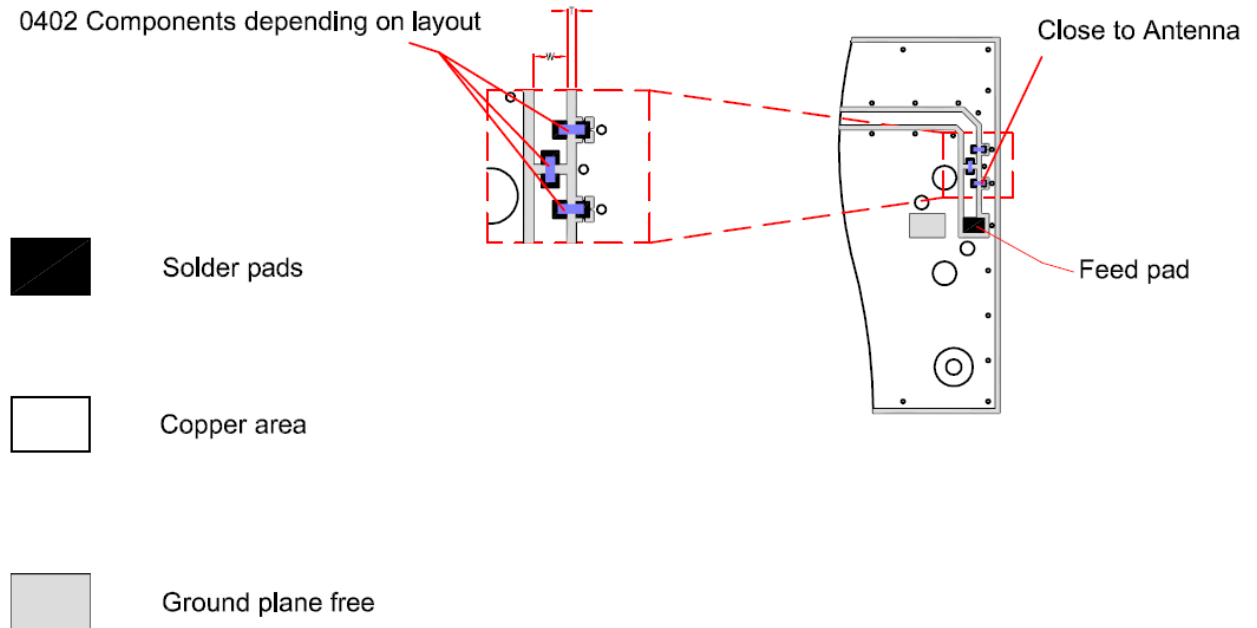

In addition to the matching circuit, a separate DC blocking capacitor will also be required between the radio and the antenna matching circuit.

Note: The component values for the matching circuit will vary depending on the size of the PCB and surrounding components. The impedance of the antenna should be measured before selecting suitable matching components. Antenova M2M offers this service on request. Contact sales@antenova-m2m.com for further information.

10-3 Antenna placement

Antenova M2M strongly recommends placing the antenna near the edge of the board.

10-4 Reference board

The reference board has been designed for evaluation purposes of Picea 2.4 GHz and it includes a SMA female connector

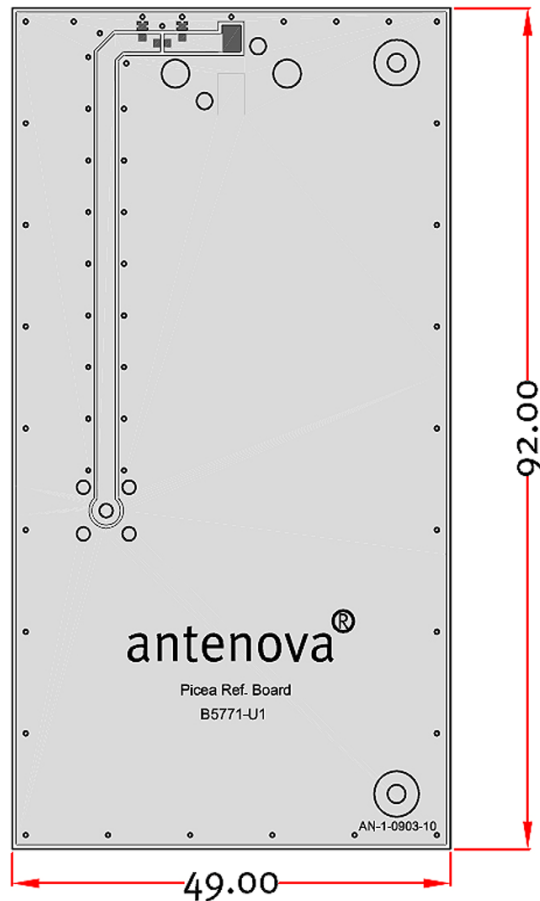

Dimensions in mm

To order a reference board contact sales@antneova-m2m.com.

11 Hazardous material regulation conformance

The antenna has been tested to conform to RoHS requirements. A certificate of conformance is available from Antenova M2M's website.

12 Packaging

12-1 Optimal storage conditions

Temperature	-10°C to 40°C
Humidity	Less than 75% RH
Shelf Life	48 Months
Storage place	Away from corrosive gas and direct sunlight

12-2 Packaging information

The antennas are delivered in bulk, enclosed in plastic bags.

12-3 Bag label information

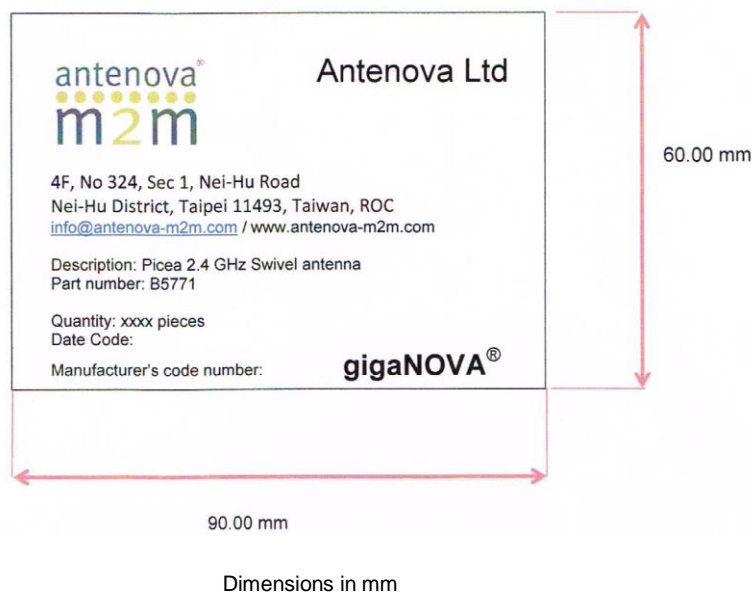



www.antenova-m2m.com

Corporate Headquarters

Antenova Ltd.
2nd Floor, Titan Court
3 Bishop Square
Hatfield
AL10 9NA

North America Headquarters

Antenova Ltd.
100 Brush Creek Road, Suite 103
Santa Rosa
California 95404
USA

Asia Headquarters

Antenova Asia Ltd.
4F, No. 324, Sec. 1, Nei-Hu Road
Nei-Hu District
Taipei 11493
Taiwan, ROC

Tel: +44 1223 810600
Email: sales@antenova-m2m.com

Tel: +1 707 890 5202
Email: sales@antenova-m2m.com

Tel: +886 (0) 2 8797 8630
Fax: +886 (0) 2 8797 6890
Email: sales@antenova-m2m.com

Copyright® Antenova Ltd. All Rights Reserved. Antenova®, Antenova M2M®, gigaNOVA®, the Antenova product family names, and the Antenova and Antenova M2M logos are trademarks and/or registered trademarks of Antenova Ltd. Any other names and/or trademarks belong to their respective companies.

The materials provided herein are believed to be reliable and correct at the time of print. Antenova does not warrant the accuracy or completeness of the information, text, graphics or other items contained within these information. Antenova further assumes no responsibility for the use of this information, and all such information shall be entirely at the user's risk.



Certificate No: 4598

Antennas for Wireless M2M Applications