

UG1410A



- Protected rocker
- Illuminated or non-illuminated
- VDE (EN 61058-1) approved
- Sealed to IP65

### ELECTRICAL SPECIFICATIONS

- Current/voltage rating :
  - functions 1 (ON-OFF) and 6 (ON-ON) : 15A 12VDC, 10A 24VDC max., 10mA 14VDC min.
  - functions 4 (ON ON ON) and 4-1R (ON ON MOM) : 8A 12VDC, 5A 24VDC max.
  - other functions : 10A 12VDC, 8A 24VDC max.
- Initial contact resistance : 10 mΩ max. at 1A 2VDC
- Insulation resistance : 1.000 MΩ min. at 500VDC
- Dielectric strength : 2.000 Vrms 50 Hz min. between terminals
- Electrical life : 10.000 cycles min.
- Mechanical life : 2 position models : 100.000 cycles min.  
3 position models : 30.000 cycles min.

### MATERIALS

- Case : thermoplastic UL94-V0
- Terminals : brass, silver plated
- Contacts : silver grain
- Contact roller : brass, nickel plated

### AGENCY APPROVAL



EN 61058-1

12(4)A 250VAC  
T85/55°C

**Availability** : double pole models, functions ON-OFF and ON-ON.

**Marking** : to order switches marked VDE, add "VDE" at the end of model number.

### ENVIRONMENTAL SPECIFICATIONS

- Degree of protection : IP65 according to IEC 60529
- Shock resistance : 100 g according to IEC 512-4, test 6c
- Vibration resistance : 10-500 Hz - 10 g according to IEC 512-4, test 6d
- Salt spray resistance : 96 hours according to IEC 512-6, test 11f
- Operating temperature : 2 position models : -40°C to + 85°C  
3 position models : -10°C to + 65°C

### MATRIX MOUNTING

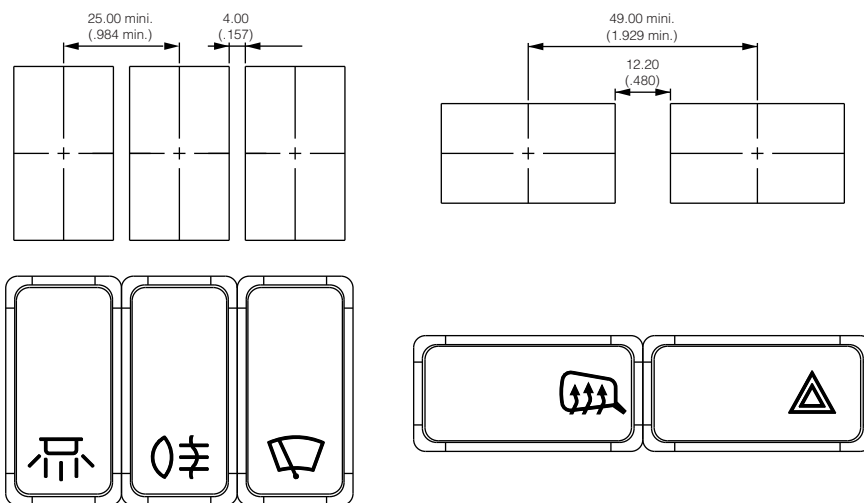

Packaging unit : 40 pieces



Sealing boots are available to protect the switches against dust and water. They are presented in section H.

**Dimensions** : First dimensions are in mm while inches are shown as bracketed numbers.

The company reserves the right to change specifications without notice.

# KG series

## Power rocker switches

### Case

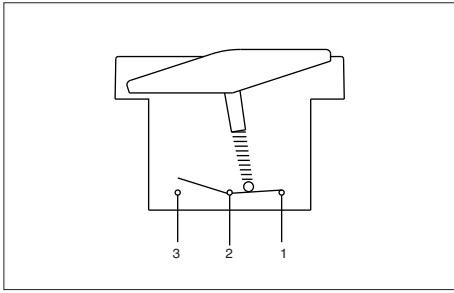

#### PANEL CUT-OUT

Panel thickness :  
0,8 mm to 4,6 mm  
Recommended thickness :  
between 2 mm and 3,5 mm

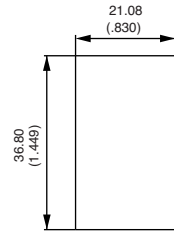

#### MODEL STRUCTURE

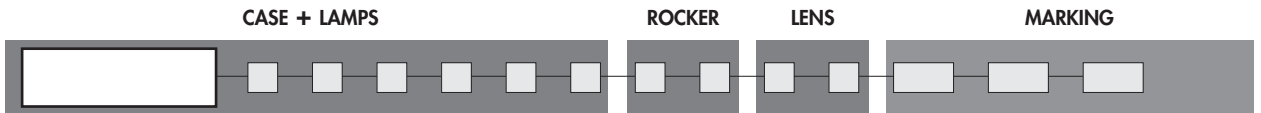

Single pole	Double pole	2-3	1-2
KG31	KG41	ON - OFF	
	KG44*	ON ON ON	
	KG44-1R*	ON ON MOM	
KG35	KG45	MOM - ON	
KG36	KG46	ON - ON	
KG37	KG47	MOM OFF MOM	
KG38	KG48	ON OFF MOM	
KG39	KG49	ON OFF ON	

5-6	4-5

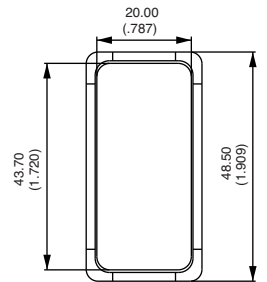
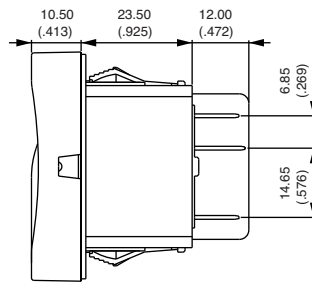
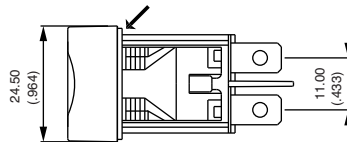

→ Flat seal

\* Function 4 : single pole in double pole case

#### TERMINALS

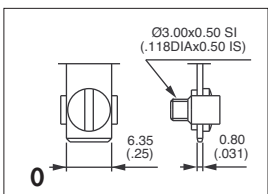
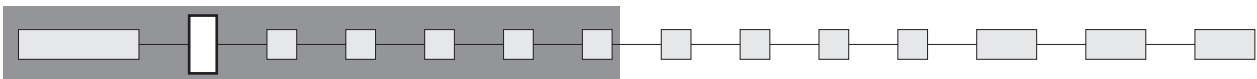

Screw

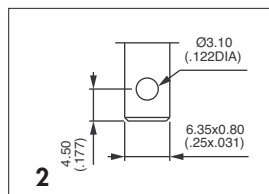

Solder lug / quick-connect

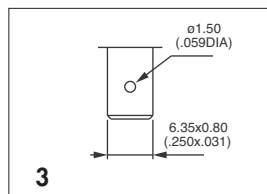

Quick-connect

Terminals 1 to 6 are marked on the case.

Side A : terminals 1 and 4  
Side B : terminals 3 and 6

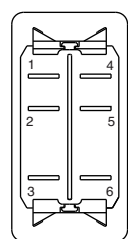

Side B

#### CONTACT MATERIALS

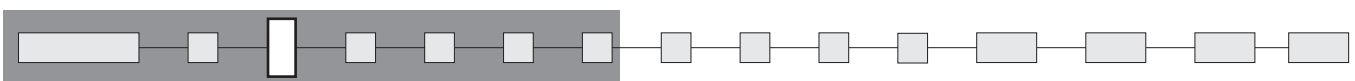

A Silver grain

**BEZEL**

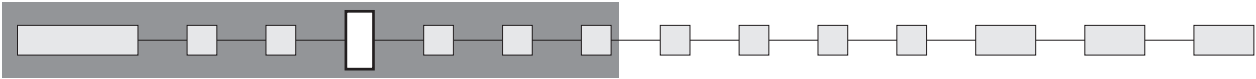

2 Black, sealed to IP65

**LAMPS**

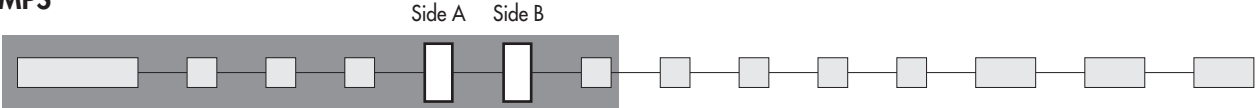

Complete each enlarged box with one of the codes listed below.

X	Without lamp
A	6V LED red
B	6V LED green
C	6V LED yellow
D	12V LED red
E	12V LED green
F	12V LED yellow
G	18V LED red
H	18V LED green
I	18V LED yellow

J	24V LED red
K	24V LED green
L	24V LED yellow
M	Neon 125V
N	Neon 250V
O	Filament 6V
P	Filament 12V
R	Filament 24V
S	Fluorescent 220V
T	Fluorescent 110V

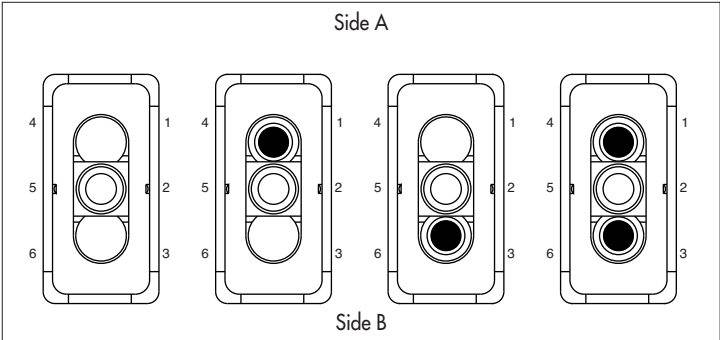

White and blue LEDs : on request.

**LAMP WIRING**

The lamp wiring diagram is shown on the case.

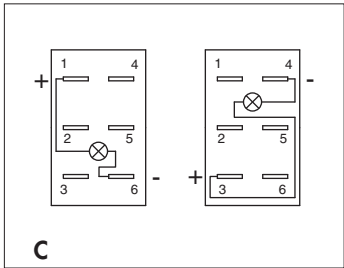
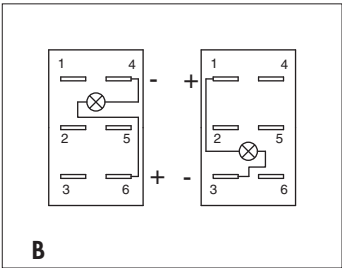
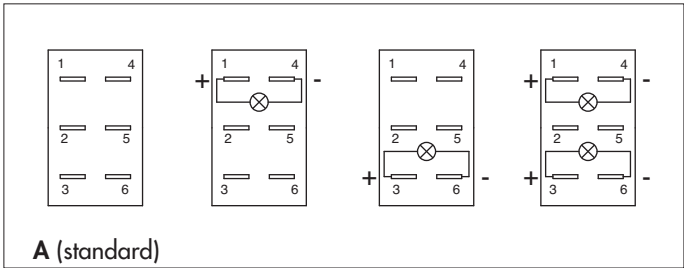
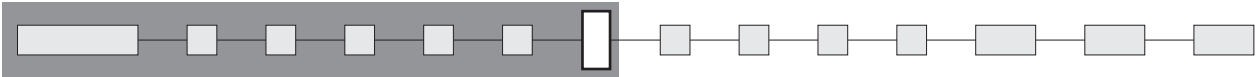

Note : If not available, terminals are added to connect the LED.

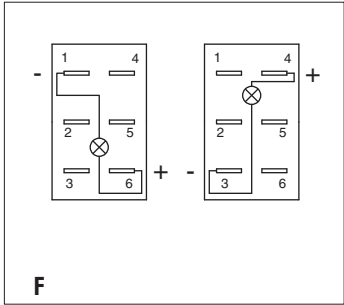
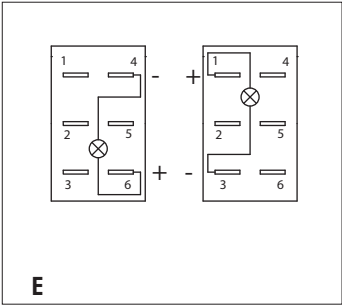
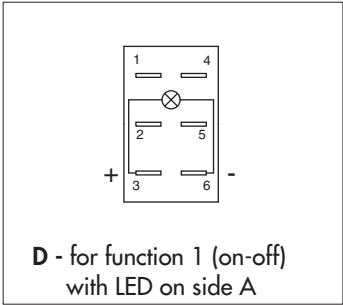

To order case only (without rocker), finish your order number with the lamp wiring code.

# KG series

## Power rocker switches

Rocker - Lenses

### ROCKER COLOUR

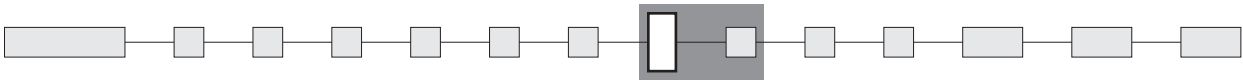

1	Blue
1/4	Dark blue
2	Black
3	Green
4	Grey

5	Yellow
6	Red
7	Ivory
9	Orange

### ROCKER SHAPE

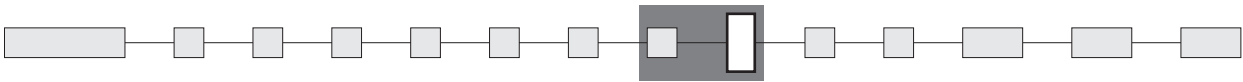

1

Full rocker



4

Opening on side A



6

Opening on side B



8

Opening on sides A and B

Other rocker shapes on customer specifications : on request.

To order rocker only (without case), begin the order number with code KGR, then follow the order format from "rocker colour" until the end of the options.

### LENS COLOUR

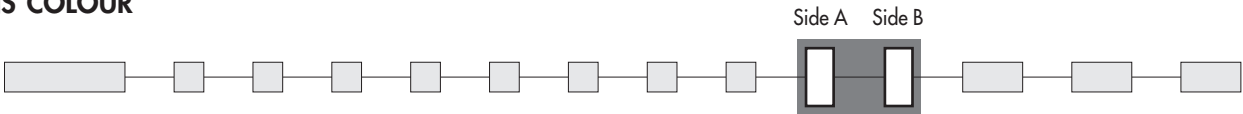

Complete each enlarged box with one of the codes listed below.

X	No lens
1	Blue *
3	Green *
6	Red
9	Orange
B	White
T	Translucent

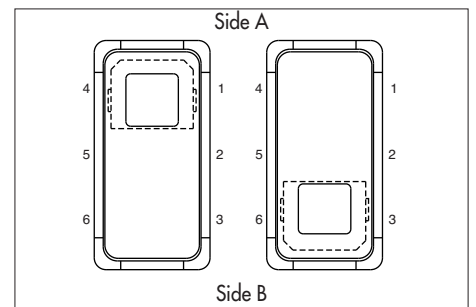

\* Blue or green lens recommended with fluorescent lamp.

To order lenses only, begin the order number with the codes :  
KGLA for lens A and KGLB for lens B,  
then follow the order format from "lens colour" until the end of the options.

# KG series

## Power rocker switches

### Marking

#### MARKING

If no marking required, leave all boxes blank.

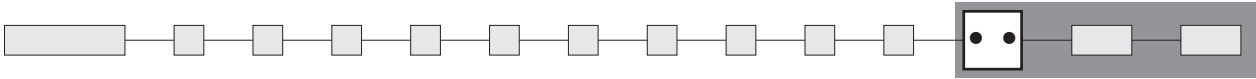

Select one option from each of the tables below.

MARKING METHOD	
C	Hot stamping

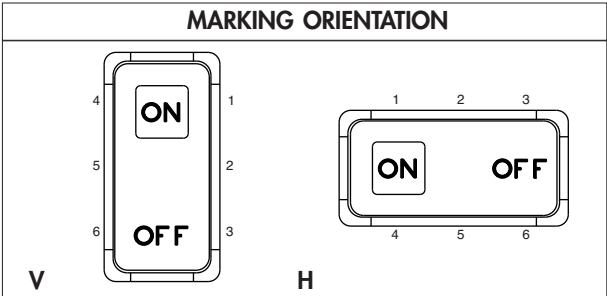

Other orientations :  
on request

#### SYMBOLS

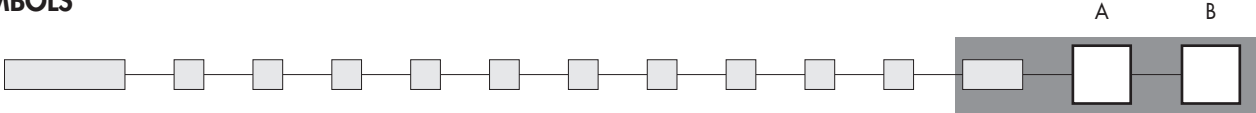

**XX** No symbol

**Available symbols** : see end of section D.

#### Marking colour

White marking for black rockers - Black marking for colour rockers  
Other : on request.

#### Marking area

For illuminated versions. The symbol will be included in the hatched area.

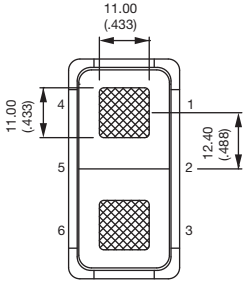
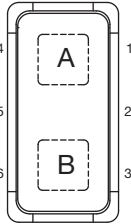

# K range

## Power rocker switches and indicators

### Symbols

UG1410A

Most symbols meet the ISO 7000 standard "graphical symbols for use on equipments" (code given in bracket in the description). Contact us for symbols not featured in the following tables.

**Legend scale :**

KR series : 1:1

KL, KG and KI series : depending on space available on the product (see "Symbols" section at the end of each series).









































CODE	SYMBOL	DESCRIPTION	CODE	SYMBOL	DESCRIPTION	CODE	SYMBOL	DESCRIPTION
XX	None	-	16		Revolving light	32		Emergency first aid vehicle (2565)
01	ON	-	17		Rear ventilator	33		Load tipping (1557)
02	OFF	-	18		Heating (0637)	34		Loading light (2457)
03	○	-	19		Door opening	35		Tractor, rear-ward (1667)
04	I	-	20		Windshield demister/defroster (0635)	36		Combine, direction of movement (1678)
05	II	-	21		Windshield wiper (0086)	37		Use no forks (2406)
06	STOP	-	22		Windshield washer (0088)	38		Transmission (1166)
07	A	Stop	23		Ventilator fan (0089)	39		Working spot light (1145)
08	M	Motion	24		Side mirror defroster	40		Engine (0640)
09		Up motion	25		Restarting pump	41		Horn (0244)
10		Down motion	26		Front fog lights (0633)	42		Lock (1656)
11		Hot	27		Rear fog lights (0634)	43		Taxi sign light (2551)
12		Cold	28		Propulsion system trim	44		Working light (1204)
13		Hazard warning (0085)	29		Beacon (1141)	45		Working light symmetric (1204)
14		Traveller lighting	30		Anchor	46		-
15		Driver lighting (1421)	31		Electric motor (0011)	47	ASM	-

Most symbols meet the ISO 7000 standard "graphical symbols for use on equipments" (code given in bracket in the description). Contact us for symbols not featured in the following tables.

**Legend scale :**

KR series : 1:1

KL, KG and KI series : depending on space available on the product (see "Symbols" section at the end of each series).

CODE	SYMBOL	DESCRIPTION	CODE	SYMBOL	DESCRIPTION	CODE	SYMBOL	DESCRIPTION
48		All wheel drive	64		Indicator	80		Front windshield heating
49		Differential lock (1662)	65		Brake release	81	AUS	Aus
50		-	66		Baggage room left door	82		Radiator fan
51		-	67		Baggage room right door	83		Remove retarder
52		-	68		Power blinds	84		Restricted speed
53	N	-	69		Engine idle control	85		Preheater
54		Rear window wiper (0097)	70	CRUISE RES/SET	Cruise res/set	86		ABS detection
55		Rear window washer (0099)	71		Driver windows up/down	87		ECAS detection
56		Lower load (2223)	72		Middle door opening	88		Engine stop
57		Cab lock (1560)	73		Front door opening	89	CRUISE RES/CAN	Cruise res/cancel
58		Extraction	74		Lighting in baggage room	90		ECAS reset
59		Pumping in	75	CRUISE ON/OFF	Cruise on/off	91		Driver windows heating
60		Rear PTO (1572)	76	TV	TV	92	CRUISE SET+/SET-	Cruise set
61		Front PTO	77		Pump	93		Air bag up/down
62		Rockshaft down	78	WC	Toilet	94		Read lighting
63		Rockshaft up	79		Toilet decontamination	95		Lighting main switch

# K range

## Power rocker switches and indicators





































### Symbols

Most symbols meet the ISO 7000 standard "graphical symbols for use on equipments" (code given in bracket in the description). Contact us for symbols not featured in the following tables.

#### Legend scale :

KR series : 1:1

KL, KG and KI series : depending on space available on the product (see "Symbols" section at the end of each series).

CODE	SYMBOL	DESCRIPTION	CODE	SYMBOL	DESCRIPTION	CODE	SYMBOL	DESCRIPTION
96		Heating using water	AD		-	AV		-
97		Low beam	AE		-	AW		-
98		Position lights	AF		-	AY		-
99		Diesel acceleration	AG		Battery charging condition (0247)	AZ		-
A1		Manual mode	AH		Turn signals (0084)	B1	HIGH	-
A2		Clockwise cabin rotation	AJ		High beam (0082)	B2	LOW	-
A3		Anticlockwise cabin rotation	AK		Differential lock, bogie (2600)	B3		-
A4		-	AL		Brushing with a rotating brush (0070)			
A5		-	AM		Differential lock, transfer case 4x4 (2475)			
A6		Parking brake	AN		Loader bucket, float (1441)			
A7		-	AP		Loader bucket (1437)			
A8		-	AQ		Rear window washer & wiper (0098)			
A9		-	AR		Header Header drive (1579)			
AA		-	AS		Excavator/backhoe boom side shift (2091)			
AB		-	AT		Chemical water treatment (1851)			
AC		-	AU		Grapple skidder, single funct° boom (1762)			



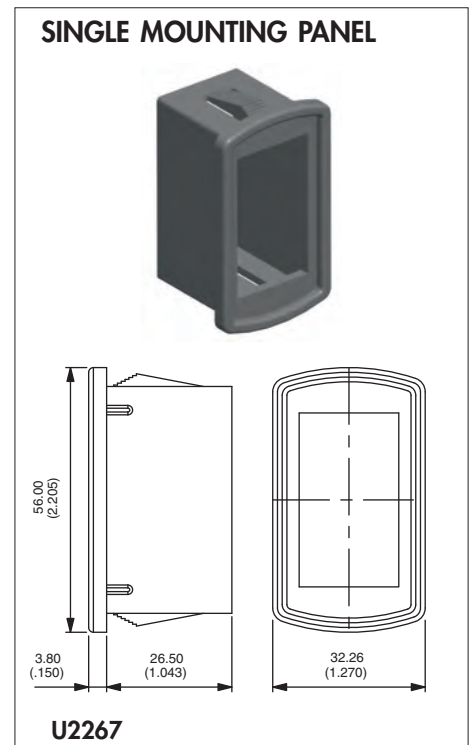
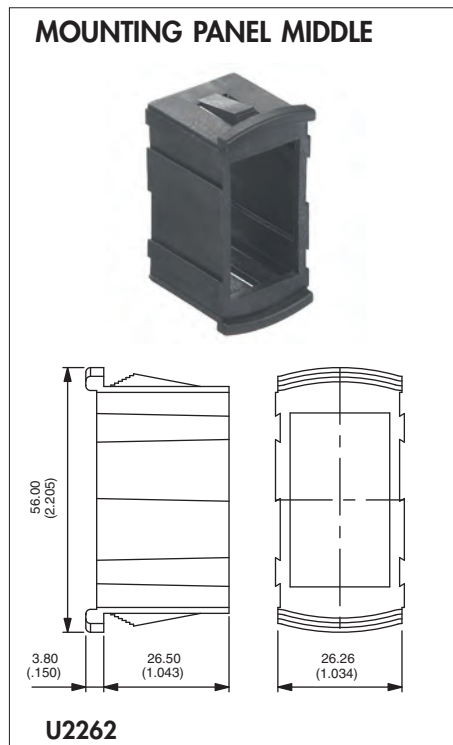
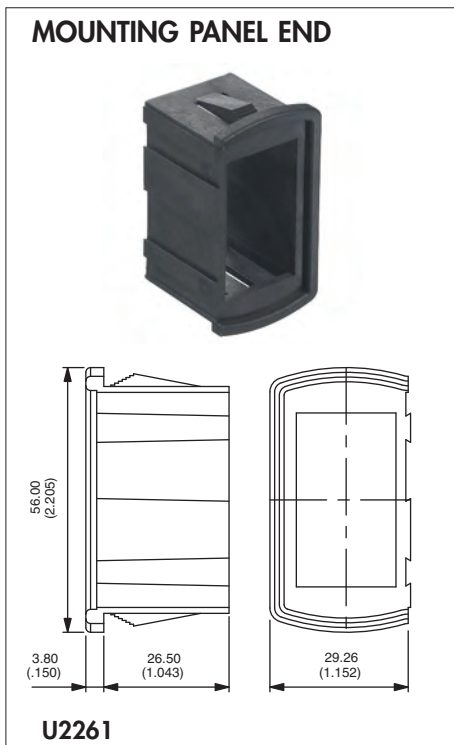

Recommended panel thickness : 1,10 mm - 1,80 mm - 2,60 mm - 3,40 mm - 4,20 mm - 5 mm - 5,80 mm

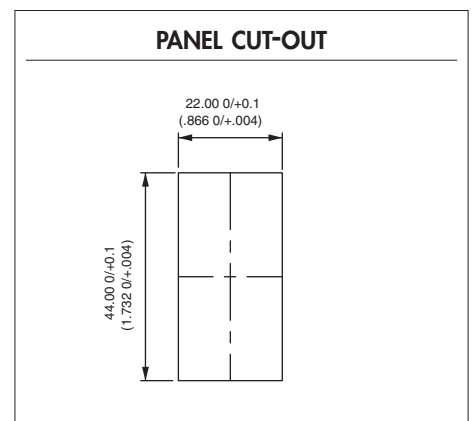
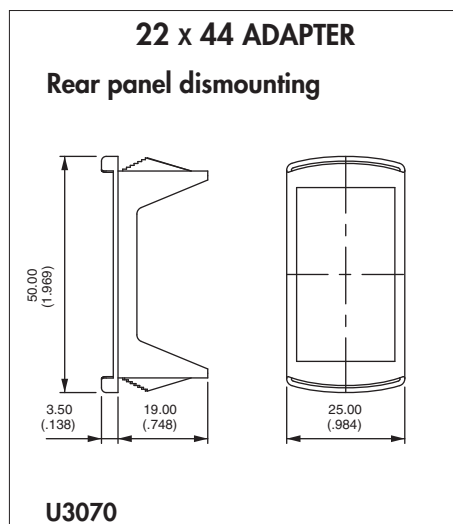
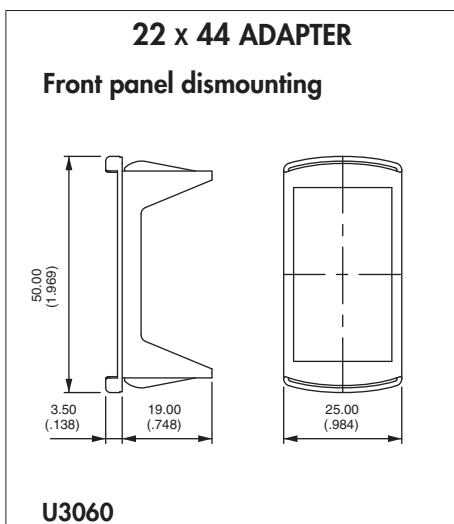
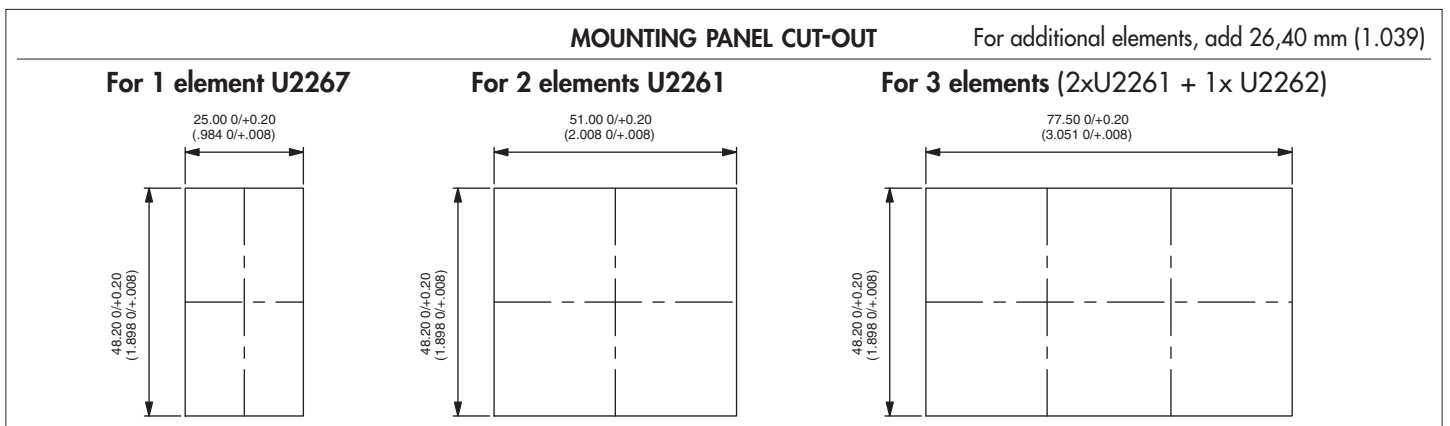

**Adapter colours** (replace 0 with code)  
**1/4** : dark blue - **2** : black - **4** : grey  
**5** : yellow - **6** : red - **7/1** : white

Recommended panel thickness : 0,60 mm to 1,50 mm

Recommended panel thickness : 1,60 mm -0,1/0 to 5,60 mm -0,1/0 in stages of 0,40 mm

# K range

## Power rocker switches and indicators

Accessories for KR, KL and KI series

### ACTUATOR REMOVING TOOL



U3052

2 tools are supplied

#### EXTRACT ACTUATOR (KR ONLY)

Allows the extraction of the rocker / rocker support assembly. Place the 2 claws under the support and push as indicated by the arrow.

#### EXTRACT ROCKER (KR ONLY)

Allows to separate the rocker from its support.

Insert the tool between rocker and support as indicated by the arrow. Pull out the tool in the opposite direction.

#### EXTRACT SWITCH (KR, KL AND KI)

Allows to extract switch from panel mounting units. 2 tools are necessary.

Insert the tools between switch and panel mounting units from the rear to compress the snap-in device. Pull off switch manually.

### CONNECTORS

Standard colour : black. Other colours : on request.  
Connectors cannot be combined with wiring types H and I.



U2260

#### 6 terminal version

For use with terminals type 2, 3, 4 or 5.  
6,35 (1/4) tabs to be fitted by the user  
(example : TE42282-2).  
Can be used for the KG series.

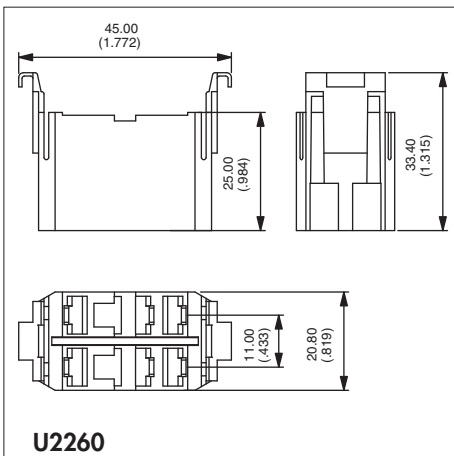

U2260



U2282

#### 10 terminal version

For use with terminals type H or J.  
2,8 (.110) tabs to be fitted by the user  
(example : AMP/Tyco 0-927779-3).

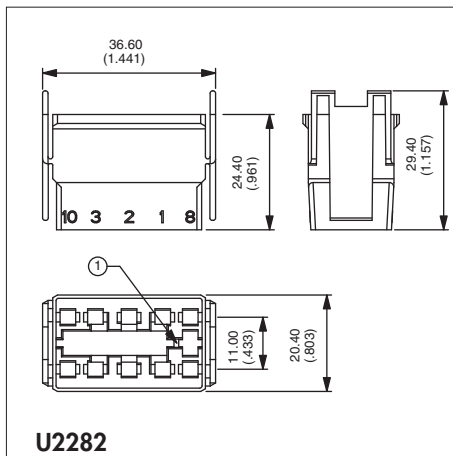

U2282



U2292

#### 10 terminal version

For use with terminals type B, C, E or F.  
6,35 (1/4) tabs to be fitted by the user  
(example : TE42282-2).

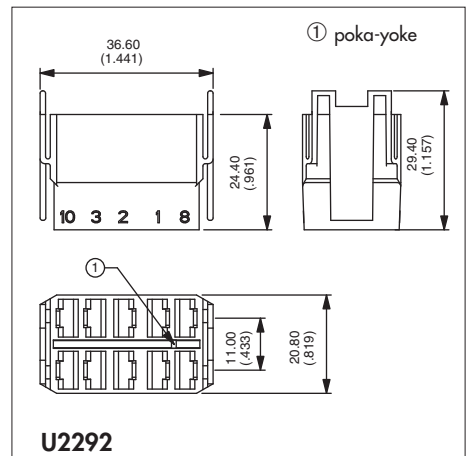

U2292

# K range

## Power rocker switches and indicators

Accessories for KR, KL and KI series

### HOLE PLUGS

Usefull for future extensions.

Code	Colour	Code	Colour
U2271	Blue	U2274	Grey
U2271/4	Dark blue	U2275	Yellow
U2272	Black	U2276	Red
U2273	Green	U2277	Ivory
		U2279	Orange

Recommended panel thickness :  
1,50 mm to 6 mm

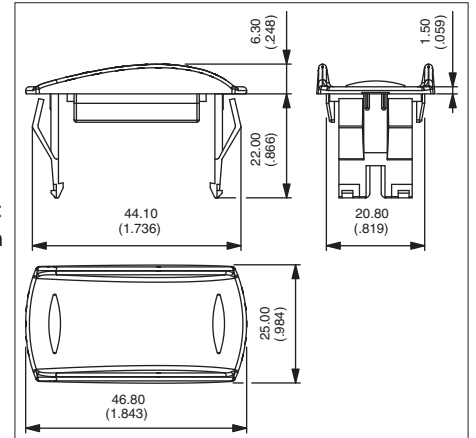

Connectors can be hanged on specific hole plugs. Contact APEM.