

# G series

## Slide switches - telecom grade

*Distinctive features and specifications*

UG1410A



- Panel and PC mount models
- 6 actuator lengths
- Wide variety of contact materials

### ELECTRICAL SPECIFICATIONS

- Max. current/voltage rating with resistive load :
  - silver contacts (codes 1 or 2) : 3A 30VDC
  - gold plated brass contacts (code 0) : 0,4VA 20VAC or DC max.
- Initial contact resistance : 10 m $\Omega$
- Insulation resistance : 1.000 M $\Omega$  min.
- Dielectric strength : 1.000 Vrms 50 Hz min.
- Electrical life with resistive load :
  - silver contacts (codes 1 or 2) : 2 positions : 40.000 cycles
  - 3 positions : 20.000 cycles
  - gold plated brass contacts (code 0) : 60.000 cycles (0,4VA max.)

### MATERIALS

- Case : PES
- Actuator : polyamide, glass filled
- Cover : stainless steel
- Contacts
  - 0 : brass, gold plated
  - 1 : silver
  - 2 : silver, gold plated
  - 5 : special contact, lower rating, minimum quantity : consult factory
- Terminal seal : epoxy

### GENERAL SPECIFICATIONS

- Travel : 2,20 mm (.086), except actuator N on SP model : 2,60 mm (.102)
- Operating temperature : -30°C to +85°C
- Recommended soldering : 300°C 5 sec. max.

The company reserves the right to change specifications without notice.

# G series

## Slide switches - telecom grade

Overview

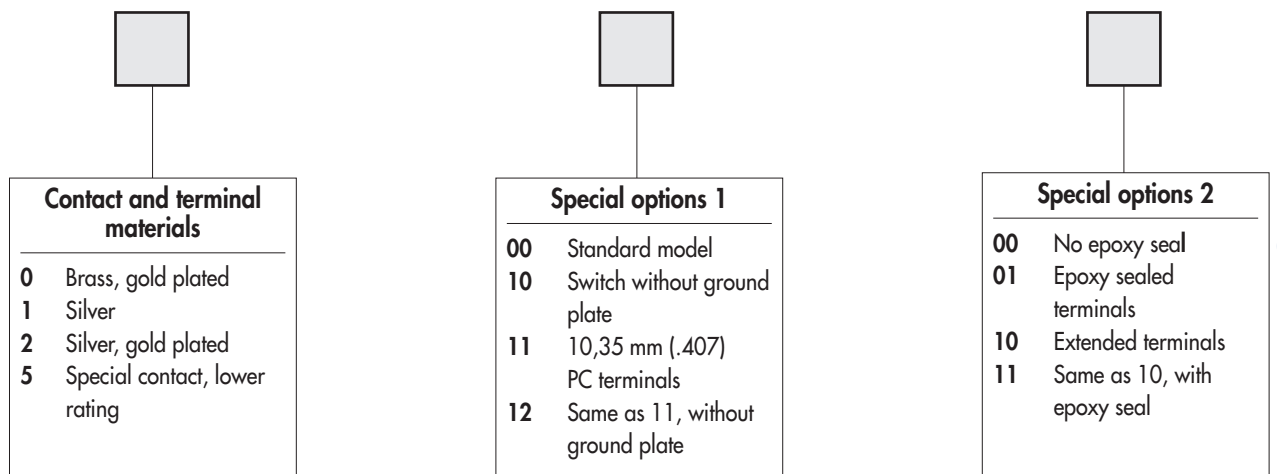
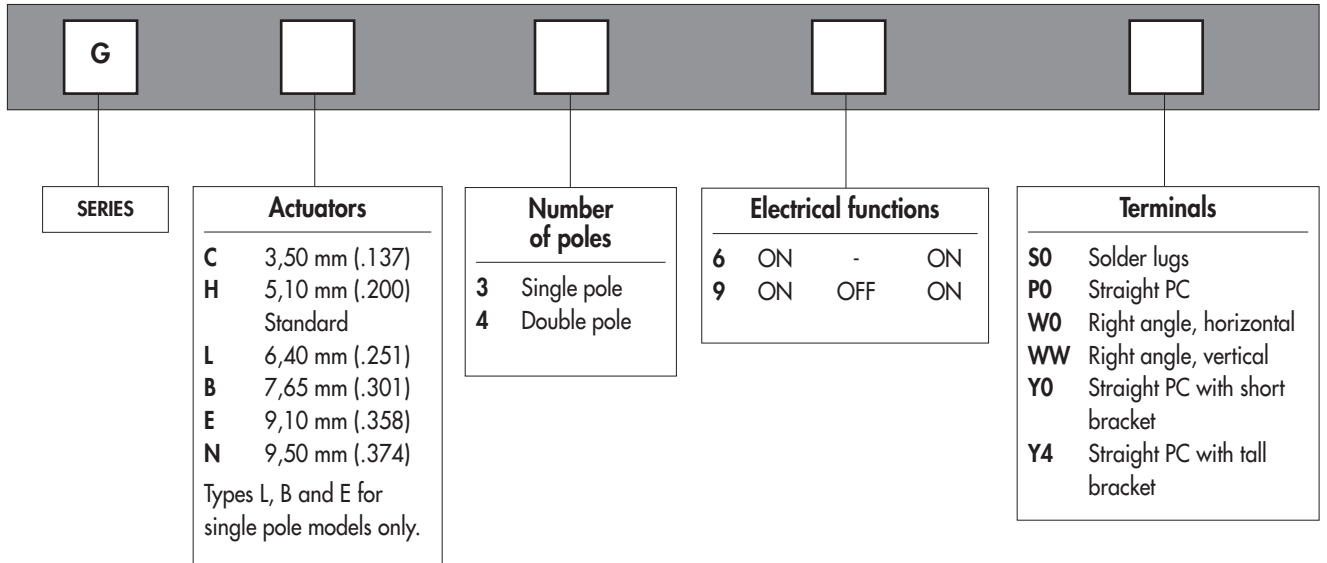

### ABOUT THIS SERIES

On the following pages, you will find successively :

- model structure of switches
- options in the same order as in above chart

**Dimensions** : first dimensions are in mm while inches are shown as bracketed numbers.



**NOTICE** : please note that not all combinations of above numbers are available. Refer to the following pages for further information.



**Packaging unit** : 100 pieces for SP solder lug (S0) and straight terminal (P0) models.  
50 pieces for other models.

# G series

## Slide switches - telecom grade

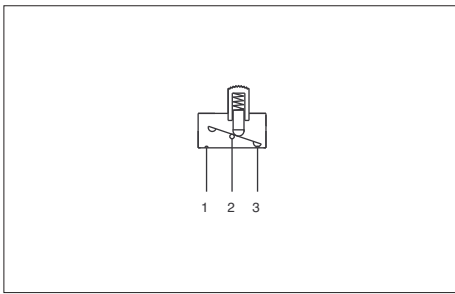

- Solder lug, straight PC or right angle terminals
- Single and double pole configurations

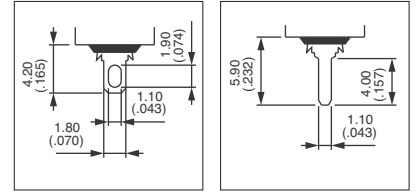

### MODEL STRUCTURE

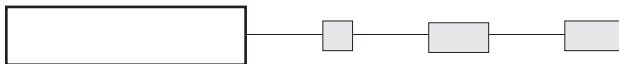

Shown with standard actuator (type H)

### Solder lug terminals



| Single pole   | Double pole   | ON | -   | ON |
|---------------|---------------|----|-----|----|
| <b>GH36S0</b> | <b>GH46S0</b> | ON | -   | ON |
| <b>GH39S0</b> | <b>GH49S0</b> | ON | OFF | ON |

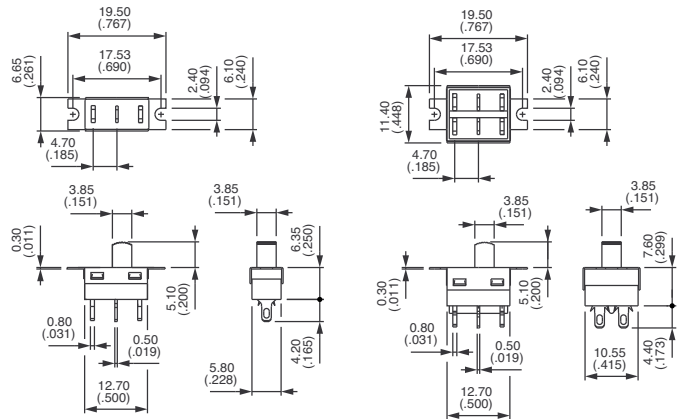

Order with epoxy sealed terminals (option 01).

### Straight PC terminals



| Single pole   | Double pole   | ON | -   | ON |
|---------------|---------------|----|-----|----|
| <b>GH36P0</b> | <b>GH46P0</b> | ON | -   | ON |
| <b>GH39P0</b> | <b>GH49P0</b> | ON | OFF | ON |

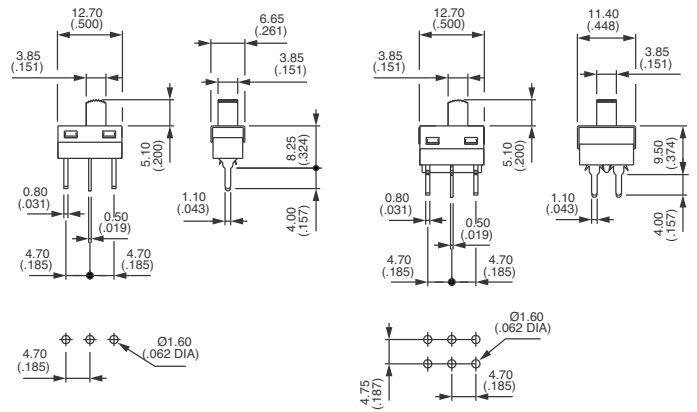

### Right angle terminals - horizontal



| Single pole   | Double pole   | ON | -   | ON |
|---------------|---------------|----|-----|----|
| <b>GH36W0</b> | <b>GH46W0</b> | ON | -   | ON |
| <b>GH39W0</b> | <b>GH49W0</b> | ON | OFF | ON |

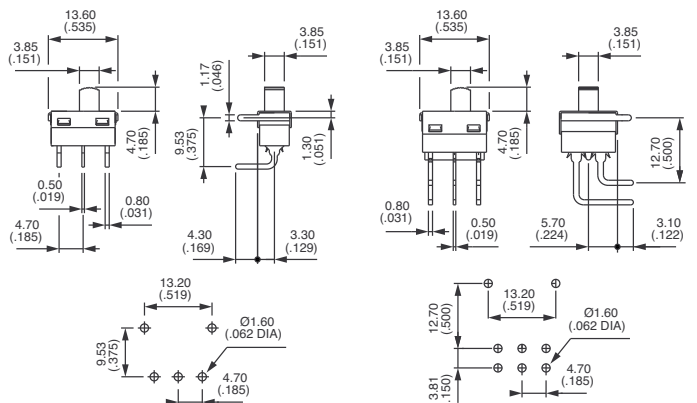

## Right angle terminals - vertical



| Single pole   | Double pole   | ON | -   | ON |
|---------------|---------------|----|-----|----|
| <b>GH36WW</b> | <b>GH46WW</b> | ON | -   | ON |
| <b>GH39WW</b> | <b>GH49WW</b> | ON | OFF | ON |

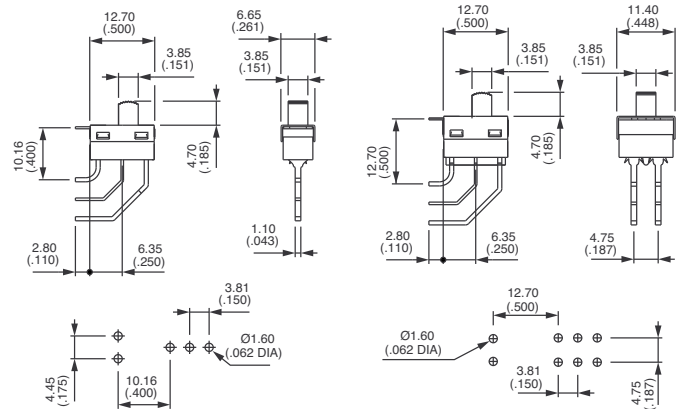

## Straight PC terminals - short bracket : Y0



| Single pole   | Double pole   | ON | -   | ON |
|---------------|---------------|----|-----|----|
| <b>GH36Y0</b> | <b>GH46Y0</b> | ON | -   | ON |
| <b>GH39Y0</b> | <b>GH49Y0</b> | ON | OFF | ON |

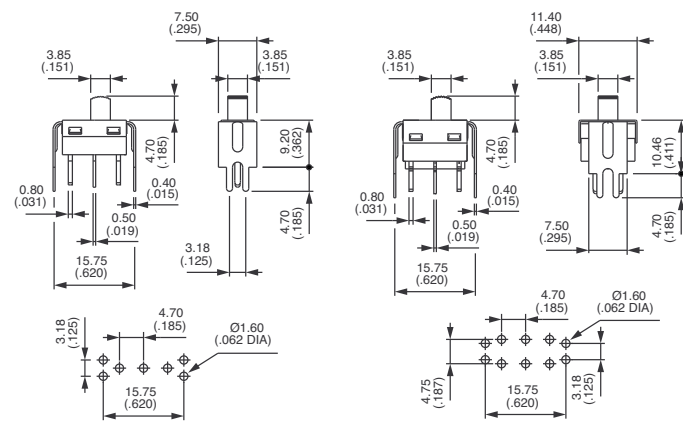

## Straight PC terminals - tall bracket : Y4



| Single pole   | Double pole   | ON | -   | ON |
|---------------|---------------|----|-----|----|
| <b>GH36Y4</b> | <b>GH46Y4</b> | ON | -   | ON |
| <b>GH39Y4</b> | <b>GH49Y4</b> | ON | OFF | ON |

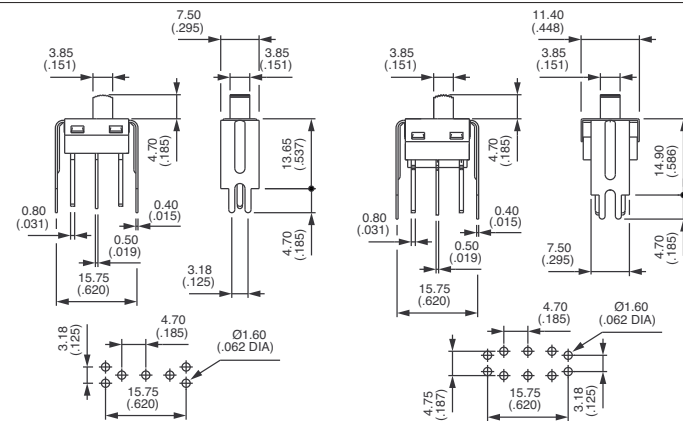

### PANEL CUT-OUT

Solder lug model

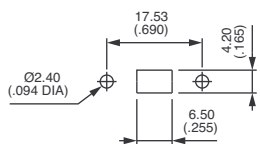

### PCB MOUNTING

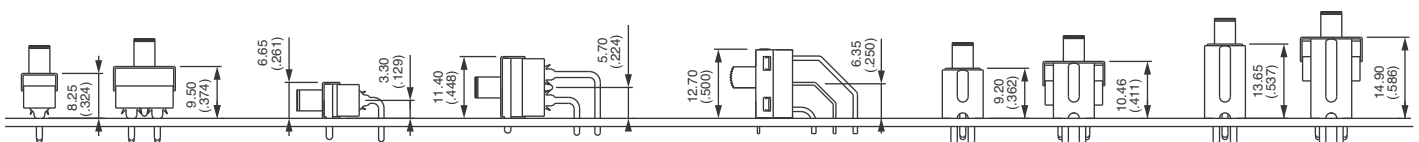

### ACTUATORS

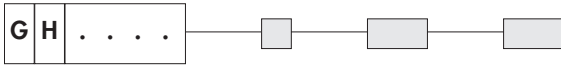

Replace second digit (H) of basic model number with one of the codes below.



Dimensions below are for solder lug (SO) and straight terminals (PO) models.  
For other models (WO - WW - Y0 - Y4), height is less 0,4 mm (.015).

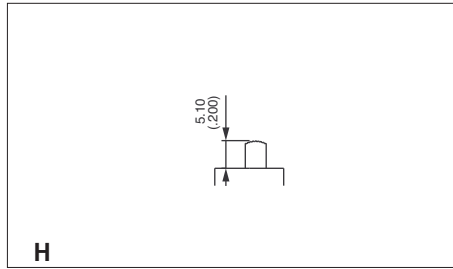
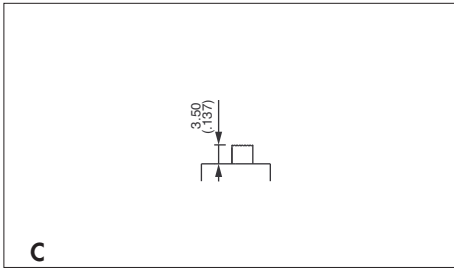

Standard

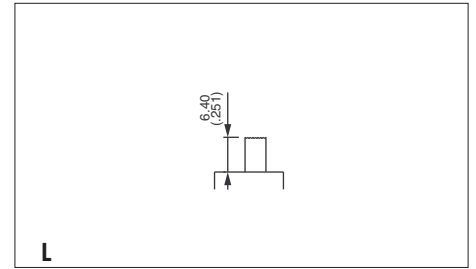

For single pole only

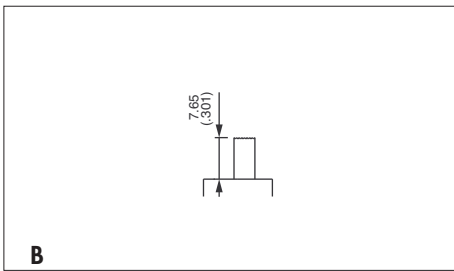

For single pole only

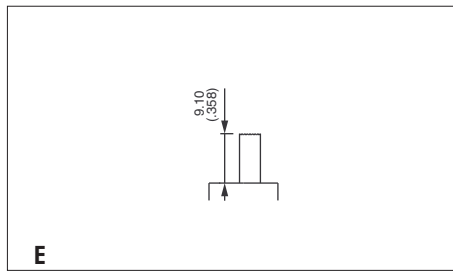

For single pole only

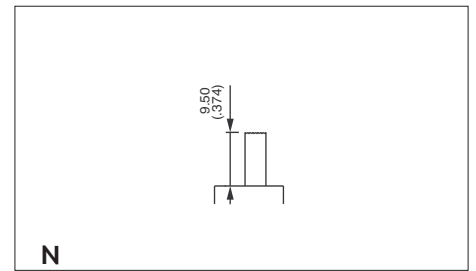

### CONTACT AND TERMINAL MATERIALS

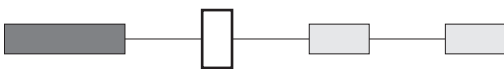

- 0** Brass, gold plated
- 1** Silver
- 2** Silver, gold plated
- 5** Special contact, lower rating, minimum quantity : consult factory



## SPECIAL OPTIONS 1

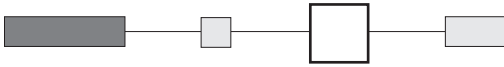

00 Standard switch as presented under "Model Structure"

10 Switch **without ground plate**  
For right angle only (W0 and WW models)

11 **10,35 mm (.407) long PC terminals**

12 **10,35 mm (.407) long PC terminals without ground plate**

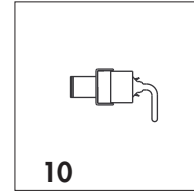

10

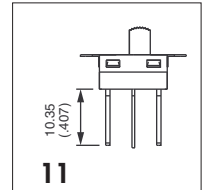

11

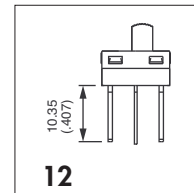

12

## SPECIAL OPTIONS 2

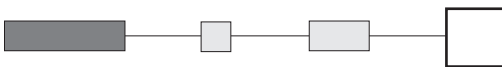

00 No epoxy seal

01 **Epoxy sealed terminals**  
(compulsory on solder lug models)

10 **Extended terminals**  
For vertical right angle (WW models)

11 **Extended terminals as above, with epoxy seal**

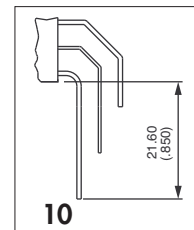

10

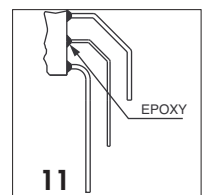

11