

Huanan Electronic Technology Co.,Ltd

4/F, Block B, Anhongji Technology Industrial Estate, Min Zhi Street, Longhua District Shenzhen
City, GuangDong Province, China

TEL: +86 755 -33168098

FAX: +86 755 -23272656

SPECIFICATION FOR LCD MODULE

**MODULE NO.: HTF0177SN-01
DOC.REVISION V1**

Customer Approval:

--

	SIGNATURE	DATE
PREPARED BY (RD ENGINEER)	HA	2012-06-24
PREPARED BY (QA ENGINEER)		
CHECKED BY		
APPROVED BY		

CONTENTS

NO.	ITEM	PAGE
-	Cover	1
-	History of Versions and Modifications	2
-	contents	3
1	General Specifications	4
2	Outline Drawing	5
3	Absolute Maximum Ratings	6
4	Led Backlight Specification and Interface Signal	7
5	Optical Characteristics	10
6	Cell test light waveform	12
7	Precautions for Use of LCD Modules	13

1.General Specifications

Item	Main LCD	Unit	Note
LCD Type	1.77" TFT LCD	-	
Display color	262K		
LCD Duty	1/160	-	
LCD Bias	-	-	
Viewing Direction	12:00	O'Clock	
Viewing Area(W×H)	-	mm	
Active Area(W×H)	28.032X35.04	mm	
Number of Dots	128(R,G,B)×160	mm	
Dot Size(W×H)	-	mm	
Dot Pitch(W×H)		mm	
Controller	ILI9163		
V _{DD}	2.7~3.3V	V	
Outline Dimensions	Refer to outline drawing on next page		
Backlight	LED(white)	-	
Operating Temperature	-20~+70°C	-	
Storage Temperature	-30~+80°C	-	
Weight	TBD	g	
Data Transfer	4 Line serial	-	
Display Type	Transmissive type	-	

Note 1: Select by software, and color tune is slightly changed by temperature and driving voltage.

Note 2: TBD- To Be Determined.

Note 3: Requirements on Environmental Protection:RoHS

3. Outline Drawing

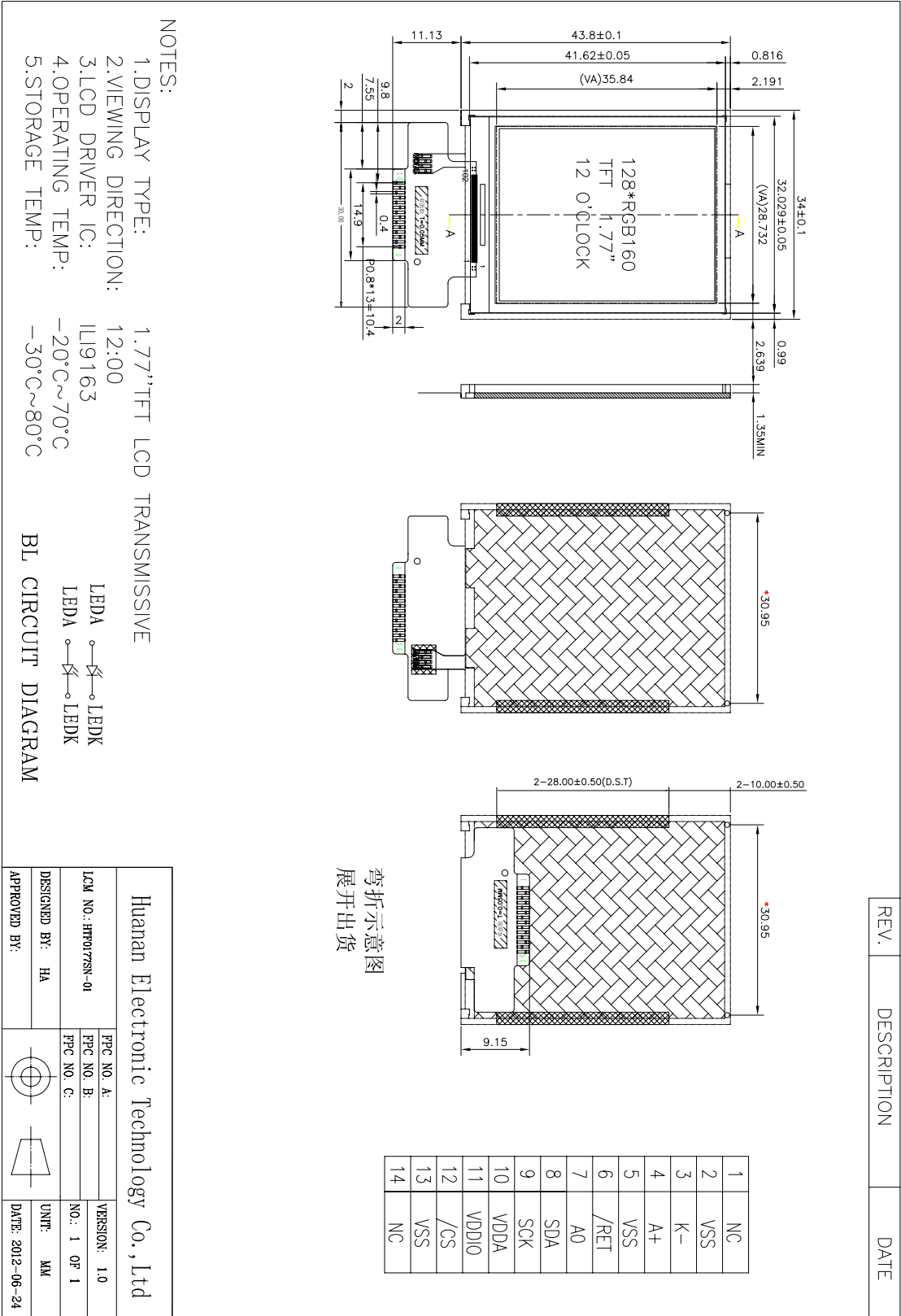

3. Absolute Maximum Raings

ITEM	SYMBOL	MIN.	MAX.	UNIT	NOTE
Operating Ambient Temperature	T _{OP}	-20	+70	°C	
Operating Ambient Humidity	H _{OP}	10	90	% (RH)	
Storage Temperature	T _{STG}	-30	+80	°C	
Storage Humidity	H _{STG}	10	90	% (RH)	

Note 1.

The absolute maximum ratings are the values that must not be exceeded at any time for this product. It is not allowed for any of these ratings to be exceeded. Should a product be used with any of the absolute maximum ratings exceeded, the characteristics of the product may not be recovered, or in an extreme case, the product may be permanently destroyed.

Therefore, when designing a system incorporating the product, make sure that adequate attentions be paid to the variations in the supply voltages, the characteristics of parts that are connected, surges in the input and output lines, and the ambient temperatures.

Note 2.

This specification applys after the driver IC mounting and the FPC mounting.

(This specification isn't applicable at time of driver IC un-mounting and FPC un-mounting.)

LCD should keep the condition that dew dosen't storage in case of driver IC un-mounting and FPC un-mounting. Dew may break the LCD. Especially part is very weak for dew.

4. LED backlight specification and Interface Signal

4.1 LED backlight specification

Item	Symbol	Min	Typ	Max	Unit	Condition
Forward Voltage	Vf	3.0	3.2	3.4	V	If=30mA
Reverse Current	Ir	=====	=====	2*10	uA	Vr= 5 V
C I E	X	0.260		0.300	=====	If=30mA
	Y	0.260		0.300		
Luminance	Lv	1500	1700	=====	cd/m ²	
Uniformity	Δ	80	85	=====	%	
Operating Temperature	Topr	-20	=====	70	°C	=====
Storage Temperature	Tstg	-35	=====	80	°C	=====

4.2 Interface Signal

PIN No.	SYMBOL	Function
1	NC	No connection
2	GND	System Ground
3	LEDK	Backlight LED1 Cathode.
4	LEDA	Backlight LED Anode.
5	GND	System Ground
6	RESET	Reset Signal pin (“Low” is enable)
7	RS	Command/display data select pin
8	SDA	Serial data input
9	SCK	Serial Clock.
10	VCC	Power supply
11	IOVC	Power supply forthe I/Ocircuit.
12	CS	Chip enable,active low
13	GND	System Ground
14	NC	No connection

5. Optical Characteristics

ITEM	SYMBOL	CONDITION	MIN.	TYP.	MAX.	UNIT	REMARK	
Transmittance(%)	T			(5.8)				
Luminance	L		(180)	(200)	—	cd/m ²		
Luminance Uniformity	ΔL		(80)	—	—	%	Note 3	
Contrast Ratio	CR		—	(300)	—		Note 4	
NTSC Ratio	---			(61%)				
Response Time	Tr	$\theta = \psi = 0^\circ$	—	(10)		ms	Note 5	
	Tf		—	(15)		ms		
View angle	Upper	$CR \geq 10$	—	(60)	—	°	Note 6	
	Lower		—	(55)	—	°		
	Left		θ	—	(50)	—		°
	Right			—	(50)	—		°
Color Coordinate	W	x	$\theta = \psi = 0^\circ$	—	(0.313)	—		
		y		—	(0.329)	—		
	R	x		—	(0.6457)	—		
		y		—	(0.3391)	—		
	G	x		—	(0.3438)	—		
		y		—	(0.6012)	—		
	B	x		—	(0.1476)	—		
		Y		—	(0.1110)	—		

Note 1. Ambient condition : 25°C±2°C , 60±10%RH , under 10 Lux in the darkroom .

Note 2. Measure device : BM-5A (TOPCON) , viewing cone=1° , I_L=20mA, after 10 minutes operation.

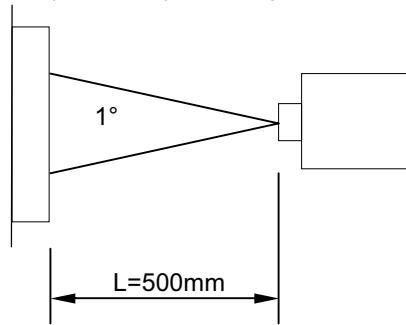

Note 3. Definition of Luminance Uniformity : $\Delta L = L(\text{MIN}) / L(\text{MAX}) \times 100\%$

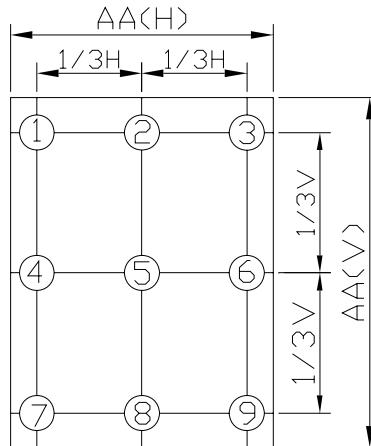

Note 4. Definition of Contrast Ratio :

$$CR = \text{White Luminance (ON)} / \text{Black Luminance (OFF)}$$

Note 5. Definition of response time : The response time is defined as the time interval between the 10% and 90% amplitudes.

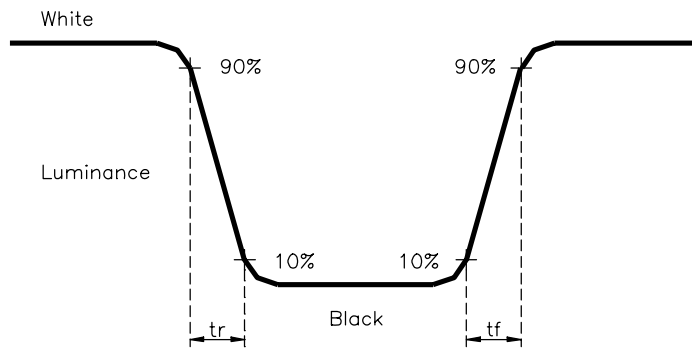

Note 6. Definition of view angle(θ , ψ) :

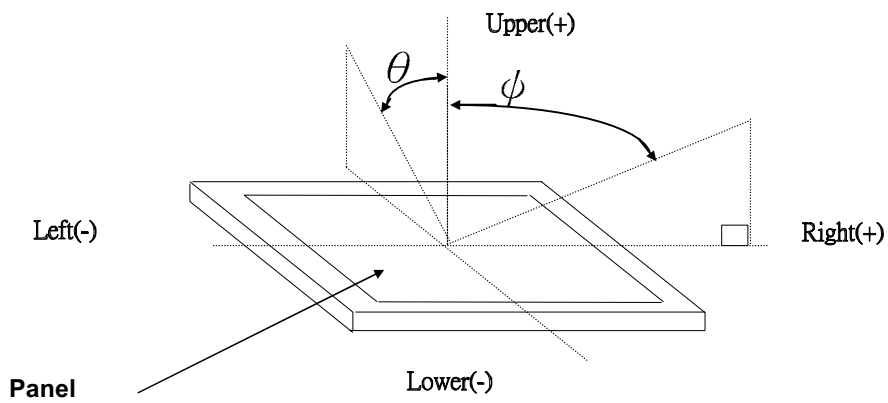

6. Cell test light waveform

EZ-Panel Testing Signal~2G1D1C

Frame	G_ODD	G_EVEN	D	Vcom
White (W)	H	H	L	DC/GND
Black (BK)	H	H	H	DC/GND
Gray (GY)	H	H	Gray	DC/GND
Scan Line ODD (ZO)	H	L	H	DC/GND
Scan Line EVEN (ZE)	L	H	H	DC/GND

Display Mode: TN, Normally White

Every Frame stay >2sec.

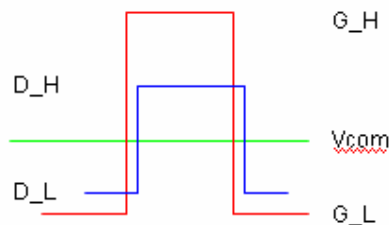
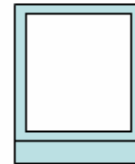

Ex. LC=5V, Vcom=0V

Data H=+/-5V, Data L=0V, Data Gray=+/-3V

Gate H=-6 ~+18V, Gate L=-6V

Just suggestion!

6.1Timing

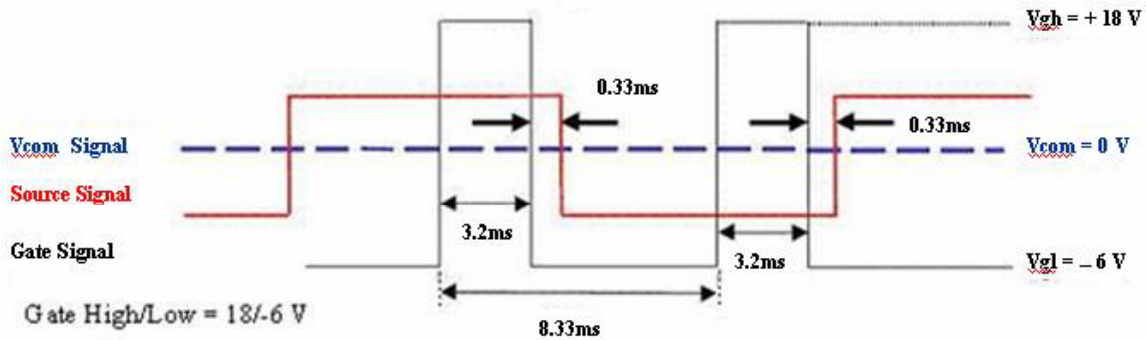

Gate High/Low = 18/-6 V
 LC = 5V
 Then V com = 0V DC
 Data High/Low = V com ± 5V
 Data freq. = 60Hz
 G freq. = 120Hz

7. Precautions for Use of LCD Modules

7.1 Handling Precautions

- 7.1.1 The display panel is made of glass. Do not subject it to a mechanical shock by dropping it from a high place, etc.
- 7.1.2 If the display panel is damaged and the liquid crystal substance inside it leaks out, be sure not to get any in your mouth, if the substance comes into contact with your skin or clothes, promptly wash it off using soap and water.
- 7.1.3 Do not apply excessive force to the display surface or the adjoining areas since this may cause the color tone to vary.
- 7.1.4 The polarizer covering the display surface of the LCD module is and easily scratched. Handle this polarizer carefully.
- 7.1.5 If the display surface is contaminated, breathe on the surface and gently wipe it with a soft dry cloth. If still not completely clear, moisten cloth with one of the following solvents:
- Isopropyl alcohol
 - Ethyl alcohol
- Solvents other than those mentioned above may damage the polarizer. Especially, do not use the following:
- Water
 - Ketone
 - Aromatic solvents
- 7.1.6 Do not attempt to disassemble the LCD Module.
- 7.1.7 If the logic circuit power is off, do not apply the input signals.
- 7.1.8 To prevent destruction of the elements by static electricity, be careful to maintain an optimum work environment.
- a. Be sure to ground the body when handling the LCD Modules.
 - b. Tools required for assembly, such as soldering irons, must be properly ground.
 - c. To reduce the amount of static electricity generated, do not conduct assembly and other work under dry conditions.

- d. The LCD Module is coated with a film to protect the display surface. Be care when peeling off this protective film since static electricity may be generated.

7.2 Storage precautions

7.2.1 When storing the LCD modules, avoid exposure to direct sunlight or to the light of fluorescent lamps.

7.2.2 The LCD modules should be stored under the storage temperature range. If the LCD modules will be stored for a long time, the recommend condition is:

Temperature : $0^{\circ}\text{C} \sim 40^{\circ}\text{C}$

Relatively humidity: $\leq 80\%$

7.2.3 The LCD modules should be stored in the room without acid, alkali and harmful gas.

7.3 The LCD modules should be no falling and violent shocking during transportation, and also should avoid excessive press, water, damp and sunshine.