

## Features

- Frequency Range 2.4 GHz to 2.5 GHz
- Supply Voltage 2.7V to 3.6V
- 32 dB Power Gain
- 23 dBm Linear Output Power for IEEE 802.11b Mode Operation
- EVM < 2.0% at 19 dBm Output Power for IEEE 802.11g Mode Operation
- On-chip Power Detector with 20 dB Dynamic Range
- Power-down Mode and Biasing Control
- Input and Interstage Matching Fully On-chip
- Low Profile Lead-free Plastic Package QFN16 (3 mm × 3 mm × 0.9 mm)

## Applications

- IEEE 802.11b DSSS WLAN
- IEEE 802.11g OFDM WLAN
- Bluetooth 2.0 Enhanced Data Rate
- PC Cards, PCMCIA, Access Points
- 2.4 GHz ISM Band Application

## 1. Description

This power amplifier (PA) is designed for high-performance 802.11b and 802.11g multi-mode applications such as Mini PCI and PCMCIA for portable devices and access points. The low profile plastic package with internal input matching to 50Ω and on-chip interstage matching minimizes the PCB board-space and allows simplified integration with very few passive components. The on-chip power detector provides a voltage linear to the output power, while the standby/bias control logic provides power-saving and shutdown options. The PA is realized as a three stage PA with internal interstage matching and an open-collector output structure.

The power amplifier is designed using Atmel®'s Silicon-Germanium (SiGe<sub>2</sub>) process and provides excellent linearity and noise performance, high gain, and good power-added efficiency.

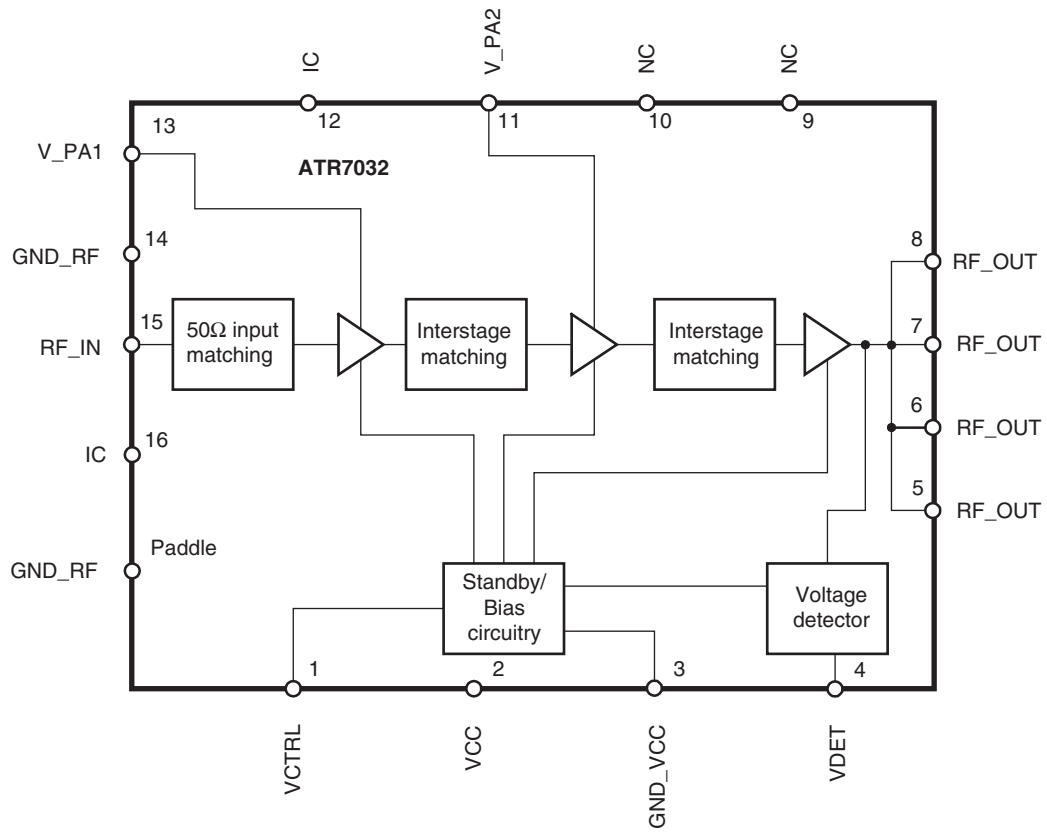


## High Gain Power Amplifier for 802.11b/g WLAN Systems

### ATR7032



Figure 1-1. Block Diagram



## 2. Pin Configuration

Figure 2-1. Pinning QFN16

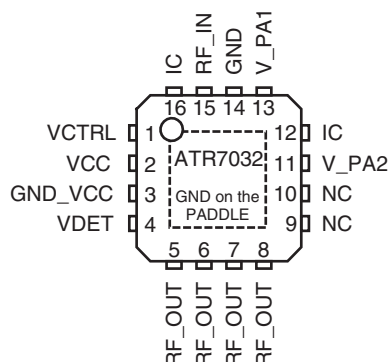


Table 2-1. Pin Description

Pin	Symbol	Function
1	VCTRL	Power-up/biasing control voltage
2	VCC	Supply voltage
3	GND_VCC	Ground
4	VDET	Power detector voltage
5	RF_OUT	RF output
6	RF_OUT	RF output
7	RF_OUT	RF output
8	RF_OUT	RF output
9	NC	Not connected
10	NC	Not connected
11	V_PA2	Supply voltage PA stage 2
12	IC	Internally connected, on-chip matching; must not be externally connected
13	V_PA1	Supply voltage PA stage 1
14	GND	Ground
15	RF_IN	RF input
16	IC	Internally connected, on-chip matching; must not be externally connected
PADDLE	GND	Ground on the PADDLE

### 3. Absolute Maximum Ratings

Stresses beyond those listed under “Absolute Maximum Ratings” may cause permanent damage to the device. This is a stress rating only and functional operation of the device at these or any other conditions beyond those indicated in the operational sections of this specification is not implied. Exposure to absolute maximum rating conditions for extended periods may affect device reliability.

Parameters	Test Conditions	Symbol	Value	Unit
Supply voltage	Without RF	$V_{CC}$	5	V
Supply current		$I_{CC}$	600	mA
Junction temperature		$T_j$	150	°C
Storage temperature		$T_{Stg}$	-40 to +125	°C
Input RF power		$P_{IN}$	12	dBm
Control voltage power up/down and biasing		$V_{VCTRL}$	0 to +3.0	V
ESD protection, all pins	EIA/JESD22-A114-B	$V_{ESD}$	500	V

Note: 1. The part may not survive all maximums applied simultaneously.

### 4. Operating Range

Parameters	Symbol	Value	Unit
Supply voltage range	$V_{CC}$	2.7 to 3.6	V
Ambient temperature range	$T_{amb}$	-40 to +85	°C
Frequency range	f	2400 to 2500	MHz

### 5. Electrical Characteristics

Test Conditions measured on Atmel's evaluation board (unless otherwise stated):  $V_{CC} = 3.3V$ , Frequency = 2.45 GHz,  $T_{amb} = 25^\circ C$

No.	Parameters	Test Conditions	Pin	Symbol	Min.	Typ.	Max.	Unit	Type*
1.0	Control voltage range	PA operating mode		$V_{VCTRL}$	1		2	V	A
1.1		Power down mode		$V_{VCTRL}$			0.2		A
1.2	Current consumption	Quiescent		$I_{CC\_Q}$		90		mA	A
1.3		Power down mode		$I_{CC\_PD}$			10	µA	A
1.4		PA operating mode		$I_{VCTRL}$			100	µA	A

\*) Type means: A = 100% tested, B = 100% correlation tested, C = Characterized on samples, D = Design parameter

## 6. Electrical Characteristics – Unmodulated Carrier

Test Conditions measured on Atmel's evaluation board (unless otherwise stated):  $V_{CC} = 3.3V$ , Frequency = 2.45 GHz,  $T_{amb} = 25^{\circ}C$

No.	Parameters	Test Conditions	Pin	Symbol	Min.	Typ.	Max.	Unit	Type*
2.0	Saturated output power	For reference		$P_{SAT}$		28.5		dBm	C
2.1	P1dB output power			P1dB		27		dBm	A
2.2	Harmonic rejection	$P_{OUT} = 23$ dBm		2f <sub>out</sub> 3f <sub>out</sub>		-45 -30		dBc dBc	C C
2.3	Small signal gain	$I_{CC\_Q}$ , small signal condition		GL		32		dB	A
2.4	Gain variation	2.4 to 2.5 GHz, $I_{CC\_Q}$ , small signal condition -40 to +85°C, $I_{CC\_Q}$ , small signal condition		$G_{varfreq}$		±1.5		dB	C
				$G_{vartemp}$		±1.5		dB	C
2.5	Reverse isolation	$I_{CC\_Q}$ , small signal condition		ISO <sub>r</sub>		40		dB	C
2.6	Input 50Ω VSWR	$I_{CC\_Q}$ , small signal condition		VSWR <sub>IN</sub>		2:1			C
2.7	Output 50Ω VSWR	$I_{CC\_Q}$ , small signal condition, with external matching		VSWR <sub>OUT</sub>		2:1			C

\*) Type means: A = 100% tested, B = 100% correlation tested, C = Characterized on samples, D = Design parameter

## 7. Electrical Characteristics – 11 Mbps CCK Modulation

Test Conditions measured on Atmel's evaluation board (unless otherwise stated):  $V_{CC} = 3.3V$ , Frequency = 2.45 GHz,  $T_{amb} = 25^{\circ}C$ , 11 Mbps CCK modulation with Gaussian transmit filtering of BT = 0.4, conforming to IEEE 802.11b

No.	Parameters	Test Conditions	Pin	Symbol	Min.	Typ.	Max.	Unit	Type*
3.0	Maximum linear output power	ACPR1 ≥ 33 dBc, ACPR2 ≥ 55 dBc		$P_{LIN}$		23		dBm	C
3.1	Linear power gain	$P_{OUT} = 23$ dBm		GL		32		dB	A
3.2	Current consumption	$P_{OUT} = 23$ dBm		$I_{CC}$		220		mA	A

\*) Type means: A = 100% tested, B = 100% correlation tested, C = Characterized on samples, D = Design parameter

## 8. Electrical Characteristics – 54 Mbps OFDM Modulation

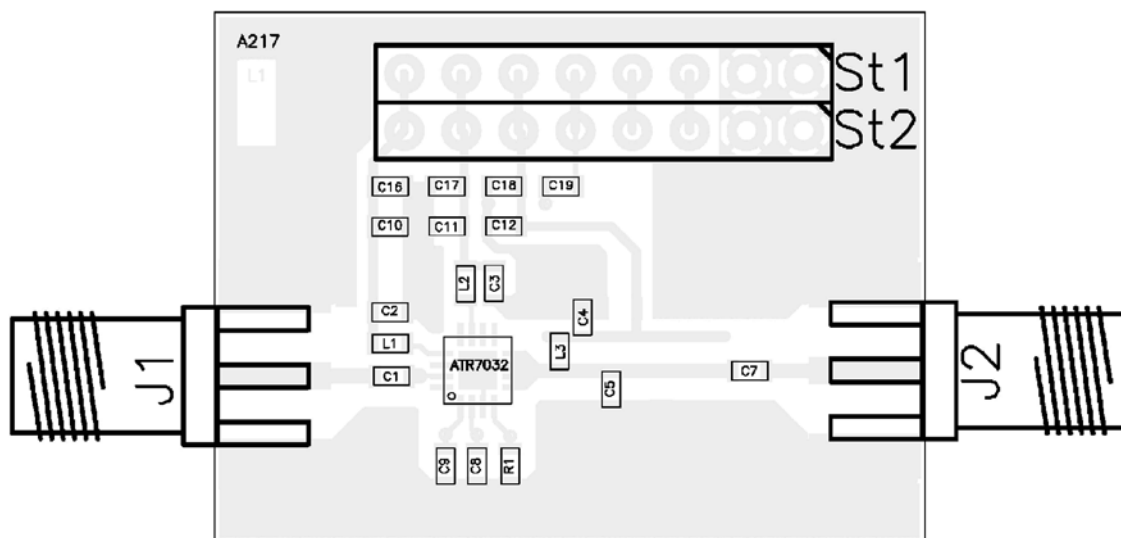
Test Conditions measured on Atmel's evaluation board (unless otherwise stated):  $V_{CC} = 3.3V$ , Frequency = 2.45 GHz,  $T_{amb} = 25^{\circ}C$ , 54 Mbps OFDM modulation, conforming to IEEE 802.11g; 0.7% EVM measurement equipment noise floor is included in the EVM measurement result.

No.	Parameters	Test Conditions	Pin	Symbol	Min.	Typ.	Max.	Unit	Type*
4.0	Error vector magnitude	$P_{OUT} = 19$ dBm		EVM		2.0		%	C
4.1	Linear power gain	$P_{OUT} = 19$ dBm		GL		32		dB	A
4.2	Current consumption	$P_{OUT} = 19$ dBm		$I_{CC}$		150		mA	A

\*) Type means: A = 100% tested, B = 100% correlation tested, C = Characterized on samples, D = Design parameter



**Figure 10-2.** Application Board Layout



**Table 10-1.** Bill of Materials for Application Board

Component	Reference	Value	Size
Capacitor	C <sub>1</sub>	4p7	0603
Capacitor	C <sub>2</sub>	56p	0603
Capacitor	C <sub>3</sub>	56p	0603
Capacitor	C <sub>4</sub>	56p	0603
Capacitor	C <sub>5</sub>	1p8	0603
Capacitor	C <sub>7</sub>	4p7	0603
Capacitor	C <sub>8</sub>	4p7	0603
Capacitor	C <sub>9</sub>	4p7	0603
Capacitor	C <sub>10</sub> <sup>(1)</sup>	10n	0603
Capacitor	C <sub>11</sub> <sup>(1)</sup>	10n	0603
Capacitor	C <sub>12</sub> <sup>(1)</sup>	10n	0603
Capacitor	C <sub>16</sub> <sup>(1)</sup>	1μ	0603
Capacitor	C <sub>17</sub> <sup>(1)</sup>	1μ	0603
Capacitor	C <sub>18</sub> <sup>(1)</sup>	1μ	0603
Capacitor	C <sub>19</sub> <sup>(1)</sup>	1μ	0603
Resistor	R <sub>1</sub>	22k	0603
Inductor	L <sub>1</sub>	15n	0603
Inductor	L <sub>2</sub>	15n	0603
Inductor	L <sub>3</sub>	15n	0603

Note: 1. Components can be omitted depending on application

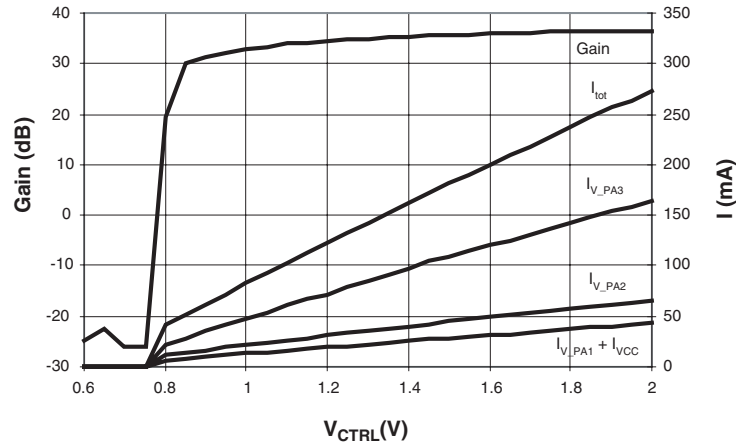
## 10.1 Evaluation Board Set-up Instructions

After connection of all cables (RF and DC):

- $V_{CC}$ ,  $V_{V\_PA1}$ ,  $V_{V\_PA2}$ ,  $V_{RF\_Out} = 3.3V$
- Increase  $V_{CTRL}$  until 90 mA quiescent current without RF signal is reached (~ 1.05V)
- Increase input power until desired linear output power is reached

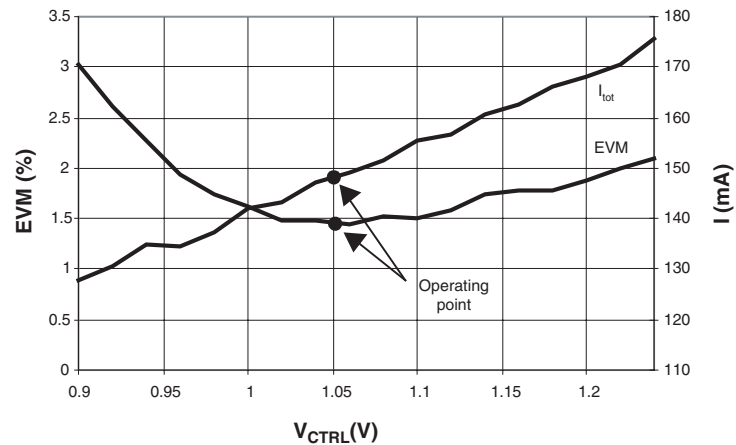
## 11. Typical Operating Characteristics

Figure 11-1. Typical Gain and Current versus Control Voltage:



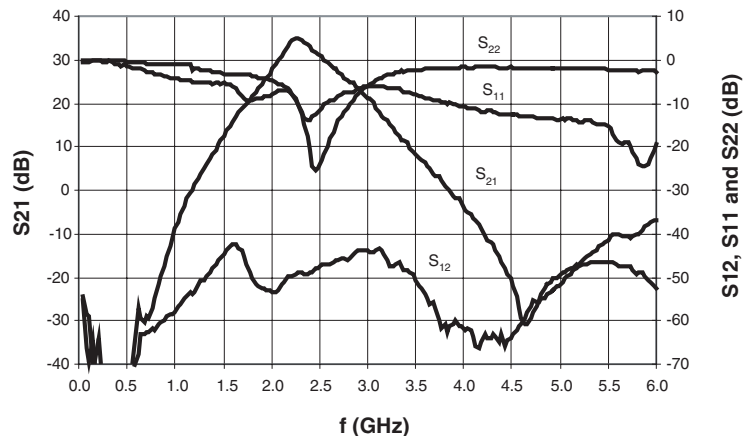
Frequency = 2450 MHz;  $P_{In} = -40$  dBm;  $V_{V\_PA1} = V_{V\_PA2} = V_{RF\_Out} = V_{CC} = 3.3V$

Figure 11-2. Typical Operating Point for 54 Mbps OFDM Modulation: Frequency = 2450 MHz;  $P_{Out} = 19$  dBm;  $V_{V\_PA1} = V_{V\_PA2} = V_{RF\_Out} = V_{CC} = 3.3V$

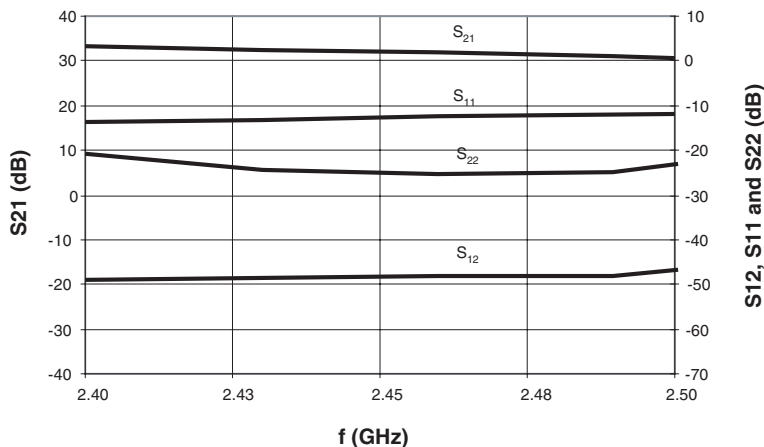




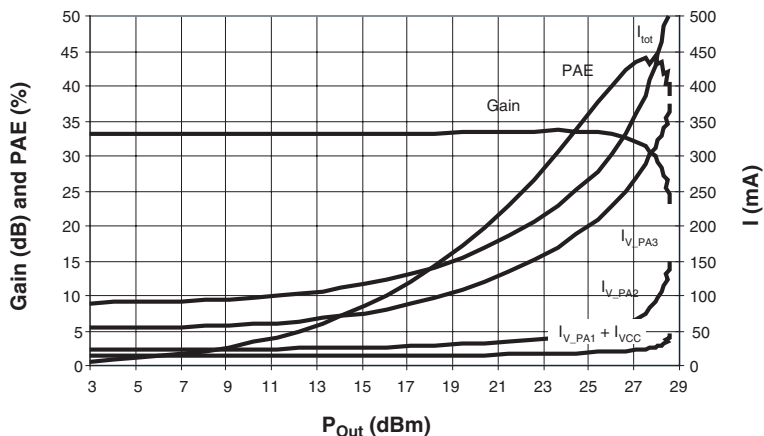
**Figure 11-3.** Typical S-Parameter at Operating Point:  $V_{VCTRL} = 1.05V$ ;  $I_{CC\_Q} = 90\text{ mA}$ ;  
 $V_{V\_PA1} = V_{V\_PA2} = V_{RF\_Out} = V_{CC} = 3.3V$



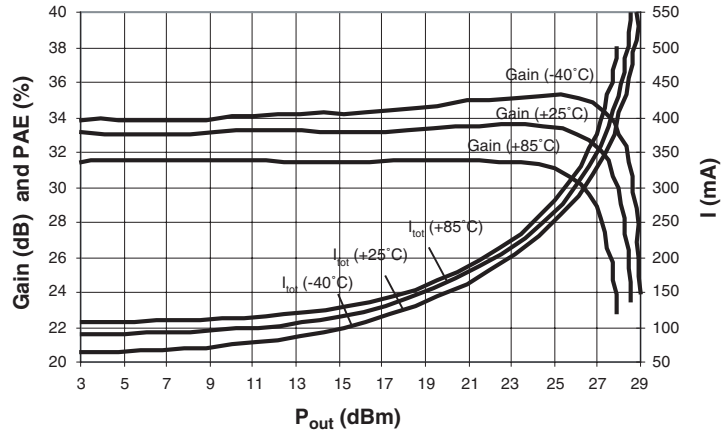
**Figure 11-4.** Typical S-Parameter at Operating Point (Detail):  $V_{VCTRL} = 1.05V$ ;  $I_{CC\_Q} = 90\text{ mA}$ ;  
 $V_{V\_PA1} = V_{V\_PA2} = V_{RF\_Out} = V_{CC} = 3.3V$



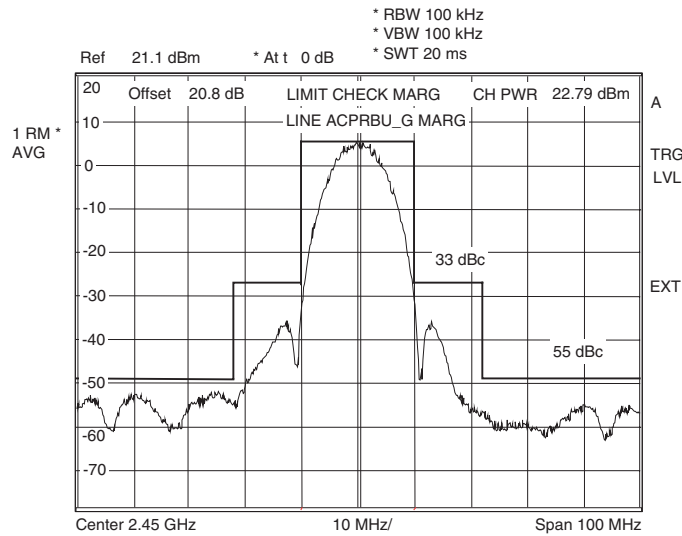
**Figure 11-5.** Typical Power-sweep with Unmodulated Carrier at Operating Point:  
 Frequency = 2450 MHz;  $V_{VCTRL} = 1.05V$ ;  $I_{CC\_Q} = 90\text{ mA}$ ;  
 $V_{V\_PA1} = V_{V\_PA2} = V_{RF\_Out} = V_{CC} = 3.3V$



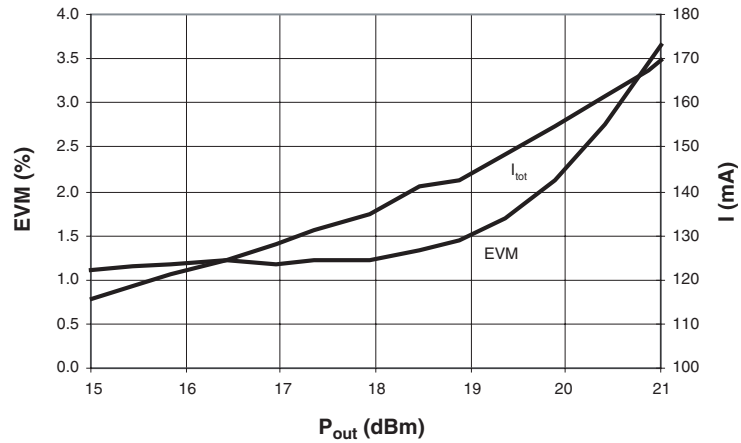
**Figure 11-6.** Typical Power-sweep with Unmodulated Carrier at Operating Point (Temperature Behavior): Frequency = 2450 MHz;  $V_{VCTRL} = 1.05V$ ;  $I_{CC\_Q} = 90\text{ mA}$ ;  $V_{V\_PA1} = V_{V\_PA2} = V_{RF\_Out} = V_{CC} = 3.3V$



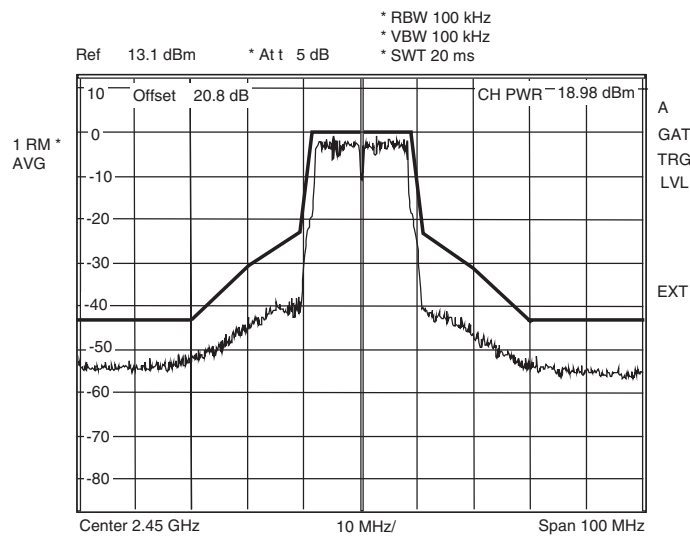
**Figure 11-7.** Typical Spectral Plot Conforming Compliance to 802.11b Spectral Mask for 11 Mbps CCK Modulation at Operating Point:  $P_{Out} = 23\text{ dBm}$ ; Frequency = 2450 MHz;  $V_{VCTRL} = 1.05V$ ;  $I_{CC} = 220\text{ mA}$ ;  $V_{V\_PA1} = V_{V\_PA2} = V_{RF\_Out} = V_{CC} = 3.3V$



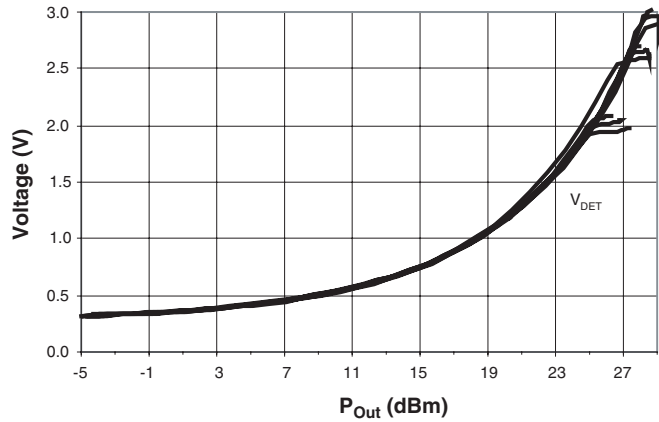
**Figure 11-8.** Typical Power-sweep with 54 Mbps OFDM Modulation at Operating Point:  
 Frequency = 2450 MHz;  $V_{VCTRL} = 1.05V$ ;  $I_{CC\_Q} = 90\text{ mA}$ ;  
 $V_{V\_PA1} = V_{V\_PA2} = V_{RF\_Out} = V_{CC} = 3.3V$



**Figure 11-9.** Typical Spectral Plot Conforming Compliance to 802.11g Spectral Mask for 54 Mbps OFDM Modulation at Operating Point:  
 $P_{Out} = 19\text{ dBm}$ ; Frequency = 2450 MHz;  $V_{VCTRL} = 1.05V$ ;  $I_{CC} = 150\text{ mA}$ ;  
 $V_{V\_PA1} = V_{V\_PA2} = V_{RF\_Out} = V_{CC} = 3.3V$

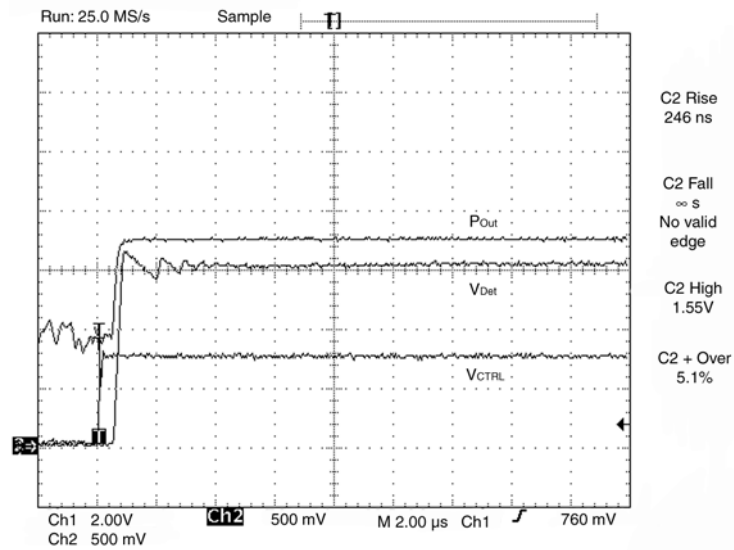


**Figure 11-10.** Typical Detector Voltage versus  $P_{Out}$  for Unmodulated Carrier (Temperature and VCC parameterized): Frequency = 2450 MHz;  $V_{VCTRL} = 1.05V$ ;  $I_{CC\_Q} = 90\text{ mA}$ ;  $V_{V\_PA1} = V_{V\_PA2} = V_{RF\_Out} = V_{CC} = 2.7V, 3.3V, 3.6V$ ;  $T_{amb} = -40^{\circ}C, 25^{\circ}C, 85^{\circ}C$



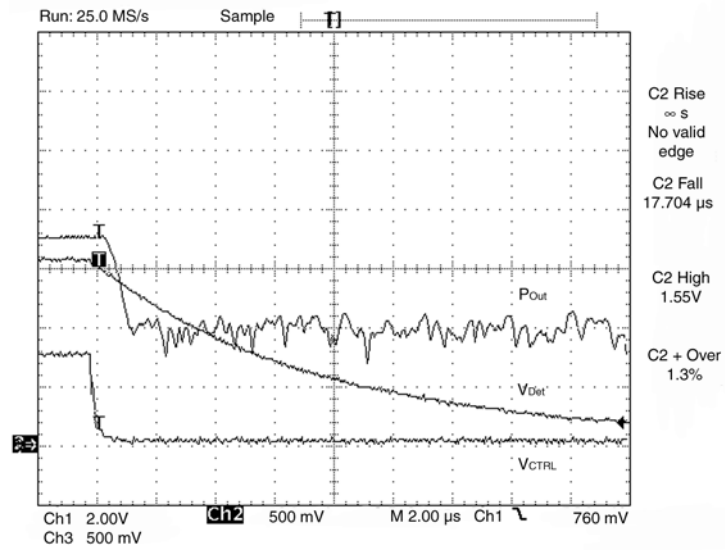
**Figure 11-11.** Power Detector Response (Rising Edge):

$P_{Out} = 23\text{ dBm}$ ; Frequency = 2450 MHz;  $V_{VCTRL} = 1.05V$ ;  $I_{CC\_Q} = 90\text{ mA}$ ;  
 $V_{V\_PA1} = V_{V\_PA2} = V_{RF\_Out} = V_{CC} = 3.3V$



**Figure 11-12. Power Detector Response (Falling Edge):**

$P_{Out} = 23 \text{ dBm}$ ; Frequency = 2450 MHz;  $V_{VCTRL} = 1.05\text{V}$ ;  $I_{CC\_Q} = 90 \text{ mA}$ ;  
 $V_{V\_PA1} = V_{V\_PA2} = V_{RF\_Out} = V_{CC} = 3.3\text{V}$



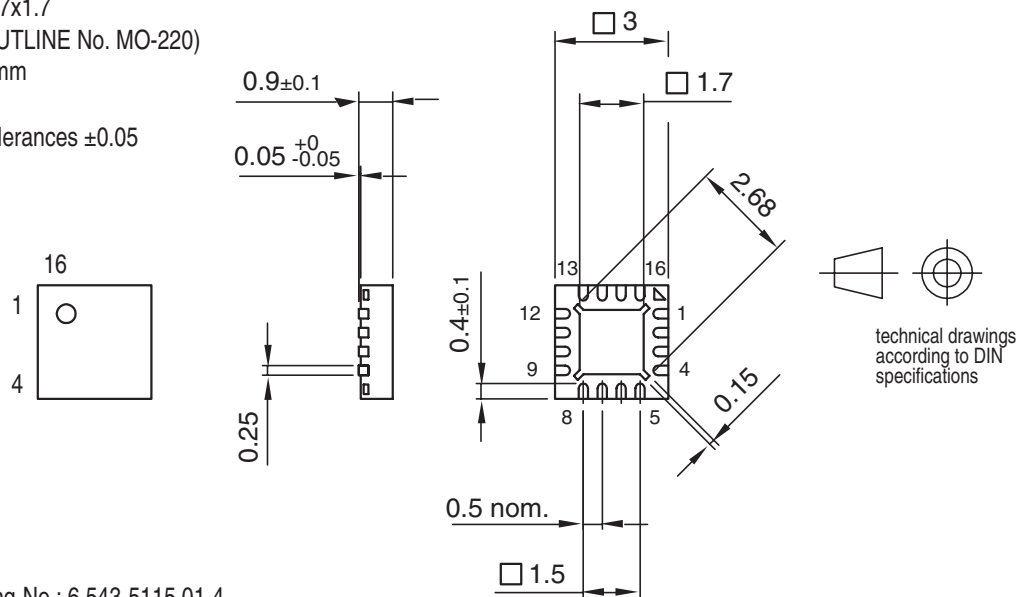
## 12. Ordering Information

Extended Type Number	Package	Remarks	MOQ
ATR7032-PVPW	QFN16, 3 × 3	Taped and 80 mm reeled, RoHs compliant	2000 pcs.
ATR7032-PVQW	QFN16, 3 × 3	Taped and 330 mm reeled, RoHs compliant	8000 pcs.
ATR7032-DEV-BOARD	–	Evaluation board	1

## 13. Package Information

Package: QFN 16 - 3x3  
Exposed pad 1.7x1.7  
(acc. JEDEC OUTLINE No. MO-220)  
Dimensions in mm

Not indicated tolerances  $\pm 0.05$



Drawing-No.: 6.543-5115.01-4

Issue: 1; 07.03.05

Assembly Chip PAC

## 14. Revision History

Please note that the following page numbers referred to in this section refer to the specific revision mentioned, not to this document.

Revision No.	History
4846D-WLAN-10/07	<ul style="list-style-type: none"> <li>Put datasheet in a new template</li> <li>Section 12 "Ordering Information" on page 14 changed</li> </ul>



## Headquarters

---

**Atmel Corporation**  
2325 Orchard Parkway  
San Jose, CA 95131  
USA  
Tel: 1(408) 441-0311  
Fax: 1(408) 487-2600

## International

---

**Atmel Asia**  
Room 1219  
Chinachem Golden Plaza  
77 Mody Road Tsimshatsui  
East Kowloon  
Hong Kong  
Tel: (852) 2721-9778  
Fax: (852) 2722-1369

**Atmel Europe**  
Le Krebs  
8, Rue Jean-Pierre Timbaud  
BP 309  
78054  
Saint-Quentin-en-Yvelines Cedex  
France  
Tel: (33) 1-30-60-70-00  
Fax: (33) 1-30-60-71-11

**Atmel Japan**  
9F, Tonetsu Shinkawa Bldg.  
1-24-8 Shinkawa  
Chuo-ku, Tokyo 104-0033  
Japan  
Tel: (81) 3-3523-3551  
Fax: (81) 3-3523-7581

## Product Contact

---

**Web Site**  
[www.atmel.com](http://www.atmel.com)

**Technical Support**  
[broadcast@atmel.com](mailto:broadcast@atmel.com)

**Sales Contact**  
[www.atmel.com/contacts](http://www.atmel.com/contacts)

**Literature Requests**  
[www.atmel.com/literature](http://www.atmel.com/literature)

---

**Disclaimer:** The information in this document is provided in connection with Atmel products. No license, express or implied, by estoppel or otherwise, to any intellectual property right is granted by this document or in connection with the sale of Atmel products. **EXCEPT AS SET FORTH IN ATMEL'S TERMS AND CONDITIONS OF SALE LOCATED ON ATMEL'S WEB SITE, ATMEL ASSUMES NO LIABILITY WHATSOEVER AND DISCLAIMS ANY EXPRESS, IMPLIED OR STATUTORY WARRANTY RELATING TO ITS PRODUCTS INCLUDING, BUT NOT LIMITED TO, THE IMPLIED WARRANTY OF MERCHANTABILITY, FITNESS FOR A PARTICULAR PURPOSE, OR NON-INFRINGEMENT. IN NO EVENT SHALL ATMEL BE LIABLE FOR ANY DIRECT, INDIRECT, CONSEQUENTIAL, PUNITIVE, SPECIAL OR INCIDENTAL DAMAGES (INCLUDING, WITHOUT LIMITATION, DAMAGES FOR LOSS OF PROFITS, BUSINESS INTERRUPTION, OR LOSS OF INFORMATION) ARISING OUT OF THE USE OR INABILITY TO USE THIS DOCUMENT, EVEN IF ATMEL HAS BEEN ADVISED OF THE POSSIBILITY OF SUCH DAMAGES.** Atmel makes no representations or warranties with respect to the accuracy or completeness of the contents of this document and reserves the right to make changes to specifications and product descriptions at any time without notice. Atmel does not make any commitment to update the information contained herein. Unless specifically provided otherwise, Atmel products are not suitable for, and shall not be used in, automotive applications. Atmel's products are not intended, authorized, or warranted for use as components in applications intended to support or sustain life.

© 2007 Atmel Corporation. All rights reserved. Atmel®, logo and combinations thereof, and others are registered trademarks or trademarks of Atmel Corporation or its subsidiaries. Other terms and product names may be trademarks of others.