Read/Write LF RFID IDIC 100 to 150kHz

DATASHEET

Features

- Contactless power supply
- Contactless Read/Write data transmission
- Radio frequency f_{RF} from 100kHz to 150kHz
- Basic Mode or Extended Mode
- Compatible with Atmel® T5557, ATA5567
- Replacement for Atmel e5551/T5551 in most common operation modes
- Configurable for ISO/IEC 11784/785 compatibility
- Total 363 bits EEPROM memory: 11 blocks (32 bits + 1 lock bit)
 - 7 × 32 bits EEPROM User Memory, including 32-bit Password Memory
 - 2 × 32 bits for unique ID
 - 1 × 32-bit option register in EEPROM to set up the Analog Front End:
 - Clock and gap detection level
 - Improved downlink timing
 - Clamp and modulation voltage
 - Soft modulation switching
 - Write damping like the Atmel T5557/ATA5567 or with resistor
 - Downlink protocol
 - 1 × 32-bit configuration register in EEPROM to set up:
 - Data rate:
 - RF/2 to RF/128, binary selectable or
 - Fixed Basic Mode rates
 - Modulation/coding:
 - Bi-phase, Manchester, FSK, PSK, NRZ
 - Other options:
 - Password Mode
 - Max block feature
 - Direct Access Mode
 - Sequence terminator(s)
 - Blockwise write protection (lock bit)
 - Answer-On-Request (AOR) Mode
 - Inverse data output
 - Disable test mode access
 - Fast downlink (~6Kbits/s versus ~3Kbits/s)
 - OTP functionality
 - Init delay (~67ms)

- High Q-antenna tolerance due to build in options
- Adaptable to different applications: access control, animal ID and waste management
- On-chip trimmed antenna capacitor:
 - 250pF/330pF ($\pm 3\%$)
 - 75pF/130pF (on request)
 - Without on-chip capacitor (on request)
- Pad options
 - Atmel ATA5577M1C
 - $100\mu\text{m} \times 100\mu\text{m}$ for wire bonding or flip chip
 - Atmel ATA5577M2C
 - $200\mu\text{m} \times 400\mu\text{m}$ for direct coil bonding

4. Atmel ATA5577C - Functional Blocks

Figure 4-1. Block Diagram

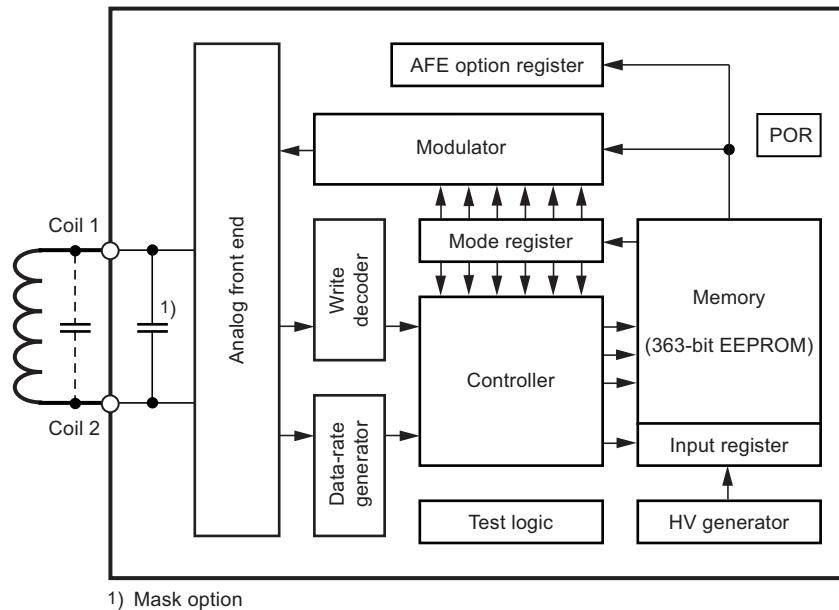

4.1 Analog Front End (AFE)

The AFE includes all circuits that are directly connected to the coil terminals. It generates the IC's power supply and handles the bi-directional data communication with the reader. It consists of the following blocks.

- Rectifier to generate a DC supply voltage from the AC coil voltage
- Clock extractor
- Switchable load between Coil1 and Coil2 for data transmission from the tag to the reader
- Field-gap detector for data transmission from the base station to the tag
- ESD-protection circuitry

4.2 AFE Option Register

The option register maintains a readable shadow copy of the data held in the EEPROM block 3, page 1. This contains the analog front end's level and threshold settings, as well as enhanced downlink protocol selection with which the device can be fine tuned for perfect operation and all application environments. It is continually refreshed during read-mode operation and (re)-loaded after every power-on reset (POR) event or reset command. By default, the option register is pre-programmed according to [Table 10-1 on page 39](#).

4.3 Data-rate Generator

The data rate is binary programmable to operate at any even-numbered data rate between $RF/2$ and $RF/128$, or to any of the fixed, basic-mode data rates ($RF/8$, $RF/16$, $RF/32$, $RF/40$, $RF/50$, $RF/64$, $RF/100$ and $RF/128$).

4.4 Write Decoder

The write decoder detects the write gaps and verifies the validity of the data stream according to the Atmel® e555x downlink protocol (pulse interval encoding).

4.5 HV Generator

This on-chip charge pump circuit generates the high voltage required to program the EEPROM.

4.6 DC Supply

Power is supplied to the IDIC externally via the two coil connections. The IC rectifies and regulates this RF source, and uses it to generate its supply voltage.

4.7 Power-On Reset (POR)

The power-on reset (POR) circuit blocks the voltage supply to the IDIC until an acceptable voltage threshold has been reached.

4.8 Clock Extraction

The clock extraction circuit uses the external RF signal as its internal clock source.

4.9 Controller

The control logic module executes the following functions:

- Load mode register with configuration data from EEPROM block 0 after power on and during reading
- Load option register with the settings for the analog front end stored in EEPROM page 1, block 3 after power on and during reading
- Control all EEPROM memory read/write access and data protection
- Handles the downlink command decoding detecting protocol violations and error conditions

4.10 Mode Register

The mode register maintains a readable shadow copy of the configuration data held in block 0 of the EEPROM. It is continually refreshed during read mode and (re-)loaded after every POR event or reset command. On delivery, the mode register is pre-programmed according to [Table 10-1 on page 39](#).

4.11 Modulator

The modulator encodes the serialized EEPROM data for transmission to a tag reader or base station. Several types of modulation are available including Manchester, bi-phase, FSK, PSK, and NRZ.

4.12 Memory

Figure 4-2. Memory Map

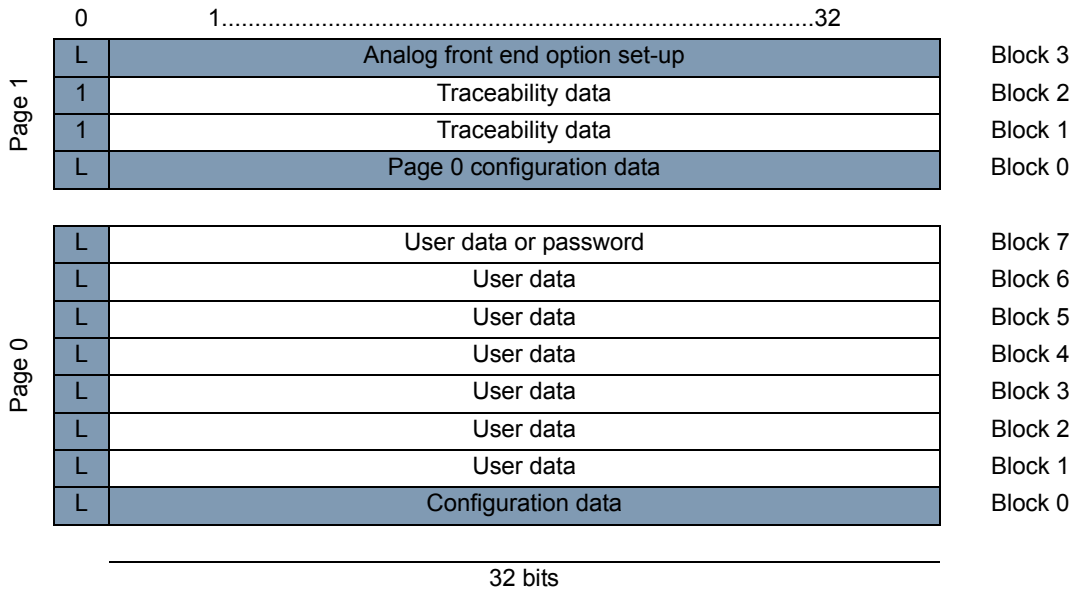

Not transmitted

The memory is a 363-bit EEPROM, which is arranged in 11 blocks of 33 bits each. Each block includes a single lock bit, which is responsible for write-protecting the associated block. Programming takes place on a block basis, so a complete block (including lock bit) can be programmed with a single command. The memory is subdivided into two page areas. Page 0 contains eight blocks, and page 1 contains three blocks. All 33 bits of a block, including the lock bit, are programmed simultaneously.

Block 0 of page 0 contains the mode/configuration data, which is not transmitted during regular-read mode operations. Addressing block 0 will always affect block 0 of page 0 regardless of the page selector. Block 7 of page 0 may be used as a protection password.

Block 3 of page 1 contains the analog front end option register, which is also not transmitted during regular-read mode operation.

Bit 0 of every block is the lock bit for that block. Once locked, the block (including the lock bit itself) is not re-programmable via the RF field.

Blocks 1 and 2 of page 1 contain traceability data and are transmitted with the modulation parameters defined in the configuration register after the opcode “11” is issued by the reader (see [Figure 5-10 on page 19](#) and [Figure 5-11 on page 19](#)). The traceability data blocks are programmed and locked by Atmel®.

4.13 Traceability Data Structure/Unique ID

Blocks 1 and 2 of page 1 contain the traceability data and are programmed and locked by Atmel® during production testing (1). The most significant byte of block 1 is fixed to E0h, the allocation class (ACL), as defined in ISO/IEC 15963-1. The second byte is, therefore, defined in ISO/IEC 7816-6 as Atmel manufacturer ID (15h). The following 5 bits indicate chip ID (CID - "00001b" for Atmel ATA5577M1, and "00010" for Atmel ATA5577M2), and the next bits (IC revision, ICR) are used by Atmel for the IC and/or foundry version of the Atmel ATA5577C.

The lower 40 bits of data encode Atmel's traceability information, and conform to a unique numbering system (unique ID). These 40 data bits contain the lot ID (year, quarter, number), wafer number (Wafer#), and die number of the wafer (DW).

Note: 1. This is only valid for sawn wafer on foil delivery.

Figure 4-3. Atmel ATA5577C Traceability Data Structure

Example:	"E0h"		"15h"				"0000 1b"				"010b"			"9h"		"00b"		"00b"		
	8 bit		8 bit				5 bit				3 bit			4 bit		2 bit		2 bit		
Bit No.	1	...	8	9	...	16	17	...	21	22	...	24	25	...	28	29	30	31	32	
Block 1	ACL		MFC				CID				ICR			Year		Quarter		Number		
Bit value	63	MSB																32		
Bit value	31	LSB																0		
Block 2	Number				Wafer#					DW										
Bit No.	1	...	12	13	...	17	18	...	31	32										
	12 bit				5 bit					15 bit										
Example:	"0000 1010 0100b"				"0110 0b"					"000 0100 1101 0010b"										

(Example is for Atmel ATA5577M1330C, Year: 2009, Quarter: 1st, Number: 0164, Wafer#: 12, DW: 1234)

ACL	Allocation class as defined in ISO/IEC 15963-1 = E0h
MFC	Atmel Corporation manufacturer code as defined in ISO/IEC 7816-6 = 15h
CID	5 bit Chip ID for identification of the different products "00001b" for Atmel ATA5577M1 and "00010b" for Atmel ATA5577M2
ICR	3-bit IC revision to identify foundry and/or revision of IC
Year	1-digit BCD encoded year of manufacturing
Quarter	2 bits for quarter of manufacturing
Number	14 bits of consecutive number
Wafer#	5 bits for wafer number
DW	15 bits designating sequential die number on wafer

5. Operating the Atmel ATA5577C

5.1 Configuring the Atmel ATA5577C

Table 5-1. Block 3 Page 1– Analog Front End Option Set-up

L	1	2	3	4	5	6	7	8	9	10	11	12	13	14	15	16	17	18	19	20	21	22	23	24	25	26	27	28	29	30	31	32
																							0	0	0	0	0	0	0	0	0	0
Lock Bit	Option Key ⁽¹⁾				Soft Modulation	Clamp Voltage	Modulation Voltage	Clock-detection Threshold	Gap-detection Threshold	Write Damping	Demod Delay	Downlink Protocol	Reserved for Future Use (RFU)																			
	0	Unlocked																										1	Locked			
				Off	0	0	0															0	0	Fixed Bit Length								
				One pulse weak	0	1	0															0	1	Long Leading Reference								
				One pulse strong	1	0	0															1	0	Leading Zero Reference								
				Two pulses	1	1	0															1	1	1 of 4 Coding Reference								
				Smooth	1	1	1															0	0	None								
				Clamp med typ ⁽²⁾ . 6V _p	0	0	0															0	1	One pulse								
				RFU	0	1																1	0	Two pulses								
				Clamp low typ ⁽²⁾ . 5V _p	1	0																1	1	RFU								
				Clamp high typ ⁽²⁾ . 8V _p	1	1																0	0	WD + low att.								
				Mod med typ ⁽²⁾ . 2V _p	0	0																0	0	WD + high att.								
				RFU	0	1																0	1	Low att.								
				Mod low typ ⁽²⁾ . 1V _p	1	0																0	1	High att.								
				Mod high typ ⁽²⁾ . 3V _p	1	1																1	0	WD only								
				Clkdet med typ. 550mV _p	0	0																1	0	Off								
				RFU	0	1																1	1	RFU								
				Clkdet low typ. 250mV _p	1	0																1	1	RFU								
				Clkdet high typ. 800mV _p	1	1																										
				Gapdet med typ. 550mV _p	0	0																										
				RFU	0	1																										
				Gapdet low typ. 250mV _p	1	0																										
				Gapdet high typ. 850mV _p	1	1																										

Notes: 1. If the option key is 6 or 9, the front end options are activated. For all other values, they take on the default state (all 0). If the option key is 6, then the complete page 1 (i.e., option register and traceability data) cannot be overwritten by any test write command. This means that if the lock bits of the three blocks of page 1 are set and the option key is 6, then all of page 1's blocks are locked against change.

2. Weak field condition

Table 5-2. Block 0 Page 0 – Configuration Mapping in Basic Mode

L	1	2	3	4	5	6	7	8	9	10	11	12	13	14	15	16	17	18	19	20	21	22	23	24	25	26	27	28	29	30	31	32																		
					0	0	0	0	0	0	0				0								0							0	0																			
Lock Bit	Master Key ^{(1), (2)}												Data Bit Rate				Modulation								PSKCF		AOR		MAX BLOCK		PWD		ST Sequence Terminator		Init Delay															
	0 Unlocked				1 Locked				RF/8 0 0 0 RF/16 0 0 1 RF/32 0 1 0 RF/40 0 1 1 RF/50 1 0 0 RF/64 1 0 1 RF/100 1 1 0 RF/128 1 1 1																0 0 RF/2		0 1 RF/4		1 0 RF/8		1 1 Res.																			
																	0 0 0 0 0 Direct																																	
																	0 0 0 0 1 PSK1																																	
																	0 0 0 1 0 PSK2																																	
																	0 0 0 1 1 PSK3																																	
																	0 0 1 0 0 FSK1																																	
																	0 0 1 0 1 FSK2																																	
																	0 0 1 1 0 FSK1a																																	
																	0 0 1 1 1 FSK2a																																	
																	0 1 0 0 0 Manchester																																	
																	1 0 0 0 0 Bi-phase																																	
																	1 1 0 0 0 Reserved																																	

Notes: 1. If the *Master Key* is 6 the test mode access is disabled
 2. If the *Master Key* is neither 6 nor 9, the extended function mode and *Init Delay* are disabled

Table 5-3. Block 0 Page 0 – Configuration Map in Extended Mode (X-mode)

L	1	2	3	4	5	6	7	8	9	10	11	12	13	14	15	16	17	18	19	20	21	22	23	24	25	26	27	28	29	30	31	32																				
					0	0	0	0							1																																					
Lock Bit	Master Key ^{(1), (2)}												Data Bit Rate				X-mode				Modulation								PSK-CF		AOR		OTP		MAX-BLOCK		PWD		Seq. Start Marker		Fast Downlink		Inverse Data		Init Delay							
	0 Unlocked				1 Locked				n5 n4 n3 n2 n1 n0				RF/(2n+2)				1												0 0 RF/2		0 1 RF/4		1 0 RF/8		1 1 Res.																	
																	Direct		0 0 0 0 0																																	
																	PSK1		0 0 0 0 1																																	
																	PSK2		0 0 0 1 0																																	
																	PSK3		0 0 0 1 1																																	
																	FSK1		0 0 1 0 0																																	
																	FSK2		0 0 1 0 1																																	
																	Manchester		0 1 0 0 0																																	
																	Bi-phase		1 0 0 0 0																																	
																	Differential bi-phase		1 1 0 0 0																																	

Note: 1. If the *Master Key* is 6 and bit 15 is set, the test mode access is disabled and the extended mode is active
 2. If the *Master Key* is 9 and bit 15 is set, the extended mode is enabled

5.2 Soft Modulation Switching

Abrupt rise of the modulation signal at the beginning of modulation - especially in applications with high-quality antennas - could lead to clock losses and, therefore, timing violations. To prevent this, several soft modulation settings can be chosen for a soft transition into the modulation state.

Soft modulation should only be used in combination with modulation schemes and data rates which do not involve high frequency-modulation changes.

Table 5-4. Soft Modulation Switching Scheme

Bit 5-7 (b13 p1)	000	010	100	110	111
Description	No soft modulation	One pulse weak	One pulse strong	Two pulses	Smooth

5.3 Demodulation Delay

Soft modulation will cause imbalance in modulated and unmodulated phases. Depending on the soft modulation setting, the unmodulated phase can be longer than the modulated phase. To balance out this mismatch, the switch point from the modulated to the unmodulated phase can be delayed for one or two pulses.

These delays and soft modulation switching should only be used in combination with modulation schemes and data rates which do not involve high frequency-modulation changes.

Table 5-5. Demodulation Delay Scheme

Bits 19 and 20 (b13 p1)	Description
00	
01	
10	

5.4 Write Damping

Reader-to-tag communication is initialized by sending a start gap from the reader station. To ease gap detection with respect to detecting subsequent field gaps reliably, receive damping and low attenuation are activated by default.

Especially in combination with high quality coils, a higher attenuation factor can be switched on to fasten the relaxation time.

Using antenna coils with low Q-factor might make it feasible to switch off the write damping. This results in better energy balance and, therefore, improved write distance.

5.5 Initialization and Init-Delay

The power-on reset (POR) circuit remains active until an adequate voltage threshold has been reached. This, in turn, triggers the default initialization delay sequence. During this configuration period of about 192 field clocks, the Atmel® ATA5577C is initialized with the configuration data stored in EEPROM block 0 and with the options stored in block 3, page 1.

Tag modulation in regular-read mode will be observed about 3ms after entering the RF field. If the init-delay bit is set, the Atmel ATA5577C variant with damping during initialization remains in a permanent damping state for $t \sim 69\text{ms}$ at $f = 125\text{kHz}$. The Atmel ATA5577C variant without damping will start modulation after $t \sim 69\text{ms}$ without damping.

- Init delay = 0: $T_{\text{INIT}} = 192 \times T_C + T_{\text{POR}} \sim 3\text{ms}$; $T_C = 8\mu\text{s}$ at $f = 125\text{kHz}$
(T_{POR} denotes delay for POR and depends on environmental conditions)
- Init delay = 1: $T_{\text{INIT}} = (192 + 8192) \times T_C + T_{\text{POR}} \sim 69\text{ms}$

Any field gap occurring during this initialization phase will restart the complete sequence. After this initialization time, the Atmel ATA5577C enters regular-read mode, and modulation starts automatically using the parameters defined in the configuration register.

5.6 Modulator in Basic Mode

The modulator consists of data encoders for the following types of modulation in Basic mode:

Table 5-6. Types of Modulation in Basic Mode

Mode	Direct Data Output		
FSK1a ⁽¹⁾	FSK/8 - FSK/5	0 = RF/8	1 = RF/5
FSK2a ⁽¹⁾	FSK/8 - FSK/10	0 = RF/8	1 = RF/10
FSK1 ⁽¹⁾	FSK/5 - FSK/8	0 = RF/5	1 = RF/8
FSK2 ⁽¹⁾	FSK/10 - FSK/ 8	0 = RF/10	1 = RF/8
PSK1 ⁽²⁾	Phase change when input changes		
PSK2 ⁽²⁾	Phase change on bit clock if input high		
PSK3 ⁽²⁾	Phase change on rising edge of input		
Manchester	0 = falling edge, 1 = rising edge		
Bi-phase	1 creates an additional mid-bit change		
NRZ	1 = damping on, 0 = damping off		

- Notes:
1. A common multiple of bit rate and FSK frequencies is recommended.
 2. In PSK mode the selected data rate has to be an integer multiple of the PSK sub carrier frequency.

5.7 Maxblock

After entering regular-read mode, the Atmel ATA5577C transmits the data content starting with block 1. The MAXBLK setting defines how many data blocks will be transmitted.

5.8 Password

When password mode is active (PWD = 1), the first 32 bits after the opcode are regarded as the password. They are compared bit by bit with the contents of block 7, starting at bit 1. If the comparison fails, the Atmel ATA5577C will not program the memory. Instead it will restart in regular-read mode once the command transmission is finished.

Note: In password mode, MAXBLK should be set to a value lower than 7 to prevent the password from being transmitted by the Atmel ATA5577C.

Each transmission of the direct access command (2 opcode bits, 32-bit password, "0" bit, plus 3 address bits = 38 bits) needs about 18ms. Testing all possible combinations (about 4.3 billion) would take about two years.

5.9 Answer-On-Request (AOR) Mode

When the AOR bit in the configuration register is set, the Atmel® ATA5577C does not start modulation in the regular-read mode after loading configuration block 0. The tag waits for a valid AOR data stream (wake-up command) from the reader before modulation is enabled. The wake-up command consists of the opcode ("10" or "11") followed by a valid password. The selected tag will remain active until the RF field is turned off or a new command with a different password is transmitted, which may address another tag in the RF field.

Table 5-7. Atmel ATA5577C - Modes of Operation

PWD	AOR	Behavior of Tag after Reset Command or POR	De-activate Function
1	1	Answer-On-Request (AOR) mode: - Modulation starts after wake up with a matching password - Programming needs valid password	Command with non-matching password deactivates the selected tag
1	0	Password mode: - Modulation in regular-read mode starts after reset - Programming and direct access needs valid password	
0	-	Normal mode: - Modulation in regular-read mode starts after reset - Programming and direct access without password	

Figure 5-1. Answer-on-request (AOR) Mode, Fixed Bit-length Protocol Example

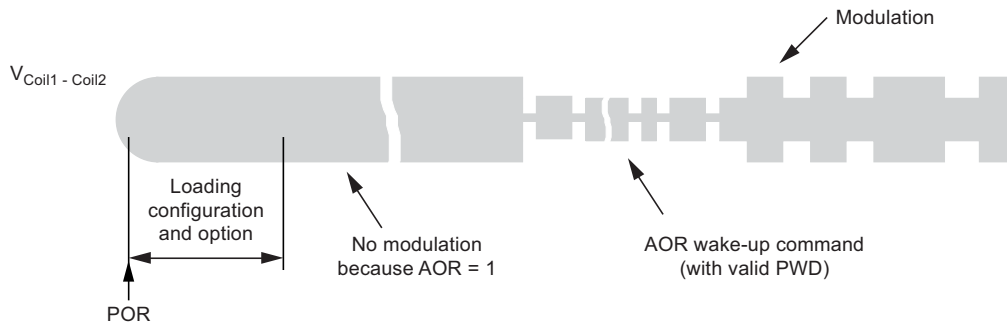
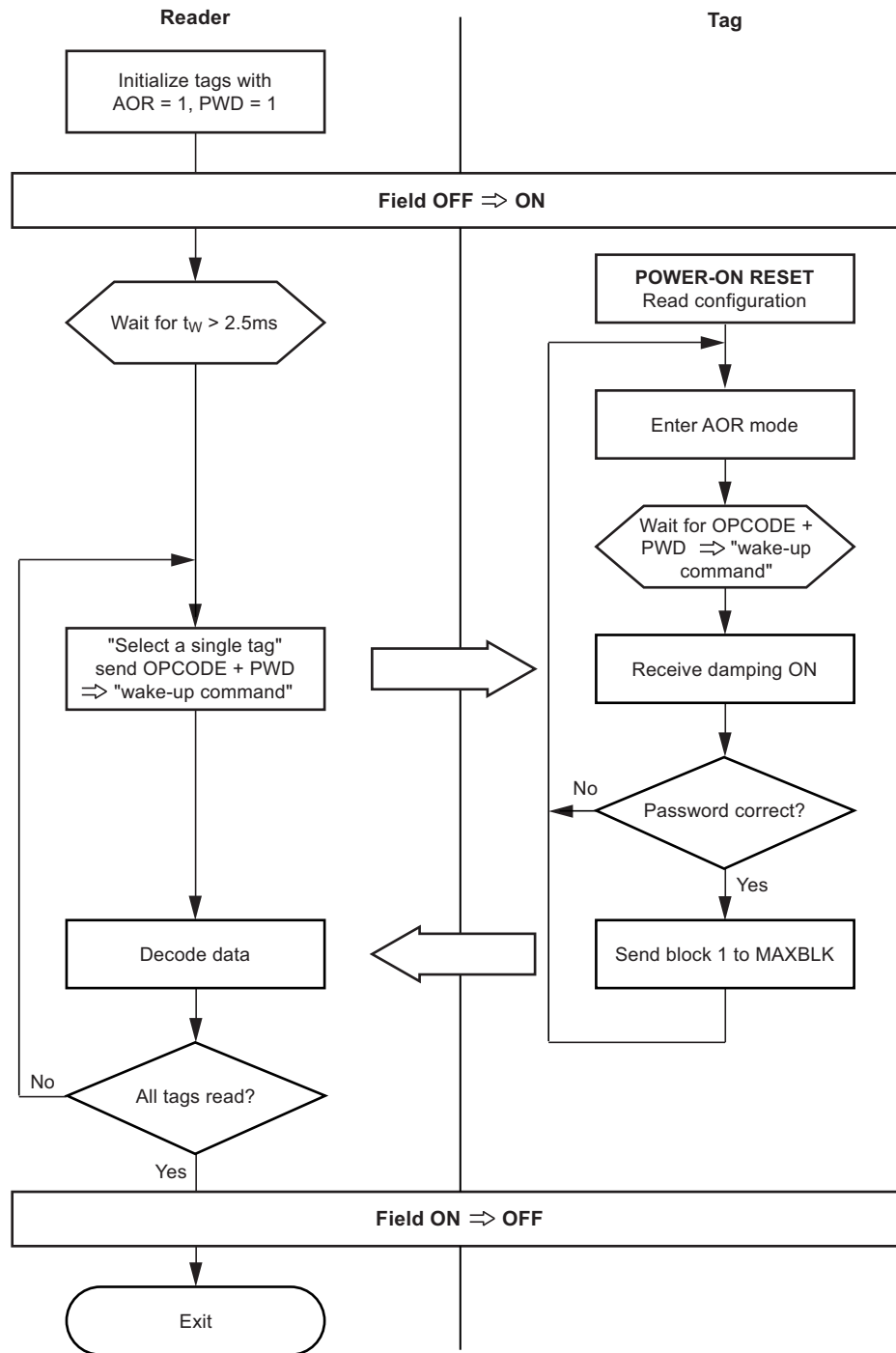

Figure 5-2. Anticollision Procedure Using AOR Mode



5.10 ATA5577C in Extended Mode (X-mode)

In general, setting of the master key (bits 1 to 4) of block 0 to the value 6 or 9 together with the X-mode bit will enable the extended mode functions such as the binary bit-rate generator, OTP functionality, fast downlink, inverse data output and sequence start marker.

- Master key = 9: Test mode access and extended mode are both enabled.
- Master key = 6: Any test mode access will be denied but the extended mode is still enabled.

Any other master key setting will prevent activation of the Atmel® ATA5577C extended mode options, even when the X-mode bit is set.

5.10.1 Modulator in Extended-Mode

Table 5-8. Atmel ATA5577C Types of Modulation in Extended Mode

Mode	Direct Data Output Encoding		Inverse Data Output Encoding		
FSK1(1)	FSK/5 - FSK/8	0 = RF/5; 1 = RF/8	FSK/8 - FSK/5	0 = RF/8; 1 = RF/5	(= FSK1a)
FSK2(1)	FSK/10 - FSK/8	0 = RF/10; 1 = RF/8	FSK/8 - FSK/10	0 = RF/8; 1 = RF/10	(= FSK2a)
PSK1(2)	Phase change when input changes		Phase change when input changes		
PSK2(2)	Phase change on bit clock if input high		Phase change on bit clock if input low		
PSK3(2)	Phase change on rising edge of input		Phase change on falling edge of input		
Manchester	0 = falling edge, 1 = rising edge mid bit		1 = falling edge, 0 = rising edge mid bit		
Bi-phase	1 creates an additional mid-bit change		0 creates an additional mid-bit change		
Differential bi-phase	0 creates an additional mid-bit change		1 creates an additional mid-bit change		
NRZ	1 = damping on, 0 = damping off		0 = damping on, 1 = damping off		

- Notes:
1. A common multiple of bit rate and FSK frequencies is recommended.
 2. In PSK mode the selected data rate has to be an integer multiple of the PSK sub-carrier frequency.

5.10.2 Binary Bit-rate Generator

In extended mode the data rate is binary programmable to operate at any even-numbered data rate between RF/2 and RF/128 as given in the formula below.

$$\text{Data rate} = \text{RF} / (2n + 2)$$

5.10.3 OTP Functionality

If the OTP bit is set to 1, all memory blocks are write protected and behave as if all lock bits are set to 1. If, in addition, the master key is set to 6, the Atmel ATA5577C mode of operation is locked forever (one-time-programming functionality).

If the master key is set to 9, test-mode access allows re-configuration of the tag.

5.10.4 Fast Downlink

In the optional fast downlink mode, the time between two gaps is reduced. In the fixed bit-length protocol mode, there are nominally 12 field clocks for a 0 and 28 field clocks for a 1. When there is no gap for more than 32 field clocks after a previous gap, the Atmel ATA5577C in the fixed bit length protocol mode will exit the downlink mode (refer to [Table 5-10 on page 20](#)).

The fast downlink mode timings for the long-leading-reference protocol are shown in [Table 5-11 on page 21](#), for the leading-zero-reference protocol in [Table 5-12 on page 21](#) and for the 1-of-4-coding protocol in [Table 5-12 on page 21](#).

5.10.5 Inverse Data Output

In extended mode (X-mode), the Atmel ATA5577C supports an inverse data output option. If inverse data is enabled, the modulator shown in Figure 5-3 works on inverted data (see Figure 5-8 on page 14). This function is supported for all basic types of encoding.

Figure 5-3. Data Encoder for Inverse Data Output

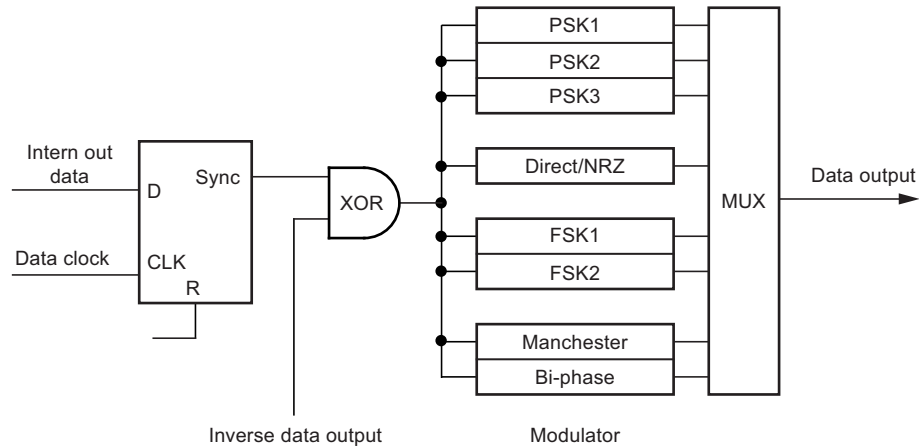

5.11 Tag-to-Reader Communication

During read operation (uplink mode), the data stored within the EEPROM are cycled, and the coil 1 and Coil 2 terminals are load modulated. This resistive load modulation can be detected at the reader device.

5.11.1 Regular-read Mode

In regular-read mode, data from the memory are transmitted serially, starting with block 1, bit 1, up to the last block (for example, 7), bit 32. The last block to be read is defined by the mode parameter field MAXBLK in EEPROM block 0. When the data block addressed by MAXBLK has been read, data transmission restarts with block 1, bit 1.

The user may limit the cyclic data stream in regular-read mode by setting MAXBLK between 0 and 7 (representing each of the eight data blocks). If set to 7, blocks 1 through 7 can be read. If set to 1, only block 1 is transmitted continuously. If set to 0, the contents of the configuration block (normally not transmitted) can be read. In the case of MAXBLK = 0 or 1, regular-read mode cannot be distinguished from block-read mode.

Figure 5-4. Examples of Different MAXBLK Settings

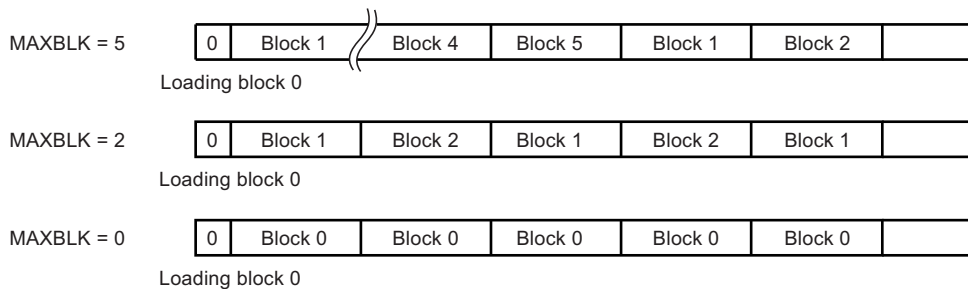

Every time the Atmel® ATA5577C enters regular or block read mode, the first bit transmitted is a logical 0. The data stream starts with block 1, bit 1, continues through MAXBLK bit 32, and, if in regular-read mode, cycles continuously.

Note: This behavior is different from that of the original Atmel e555x, and helps to decode PSK-modulated data.

5.11.2 Block-read Mode

With the direct-access command, only the addressed block is read repetitively. This mode is called block-read mode. Direct access is entered by transmitting the page access opcode (“10” or “11”), a single 0 and the requested 3-bit block address when the tag is in normal mode.

In password mode (PWD bit set), direct access to a single block needs the valid 32-bit password to be transmitted after the page access opcode, followed by a 0 and the 3-bit block address. If the transmitted password does not match the contents of block 7, the Atmel ATA5577C tag returns to regular-read mode.

Note: A direct access to block 0 of page 1 will read the configuration data of block 0, page 0.
A direct access to block 4 to 7 of page 1 reads all data bits as zero.

5.11.3 Sequence Terminator (Basic Mode)

The sequence terminator (ST) is a special damping pattern which is inserted in front of the first block and may be used to synchronize the reader. This sequence terminator is recommended only for FSK and Manchester coding. This basic mode sequence terminator consists of four bit periods. During the first and third bit period, the data value is 1. During the second and fourth bit periods, modulation is switched off (using Manchester encoding, switched on).

Bi-phase modulated data blocks need fixed leading and trailing bits in combination with the sequence terminator to be reliably identified.

The sequence terminator may be individually enabled by setting mode bit 29 (ST = 1) in basic mode (X-mode = 0).

In the regular-read mode, the sequence terminator is inserted at the start of each MAXBLK-limited read data stream.

In block-read mode, after any block write or direct access command, or if MAXBLK was set to 1, the sequence terminator is inserted before the transmission of the selected block.

This behavior is different from that of previous ICs (Atmel e5551/T5551, T5554). For further details, refer to the relevant application notes.

Figure 5-5. Read Data Stream with Sequence Terminator

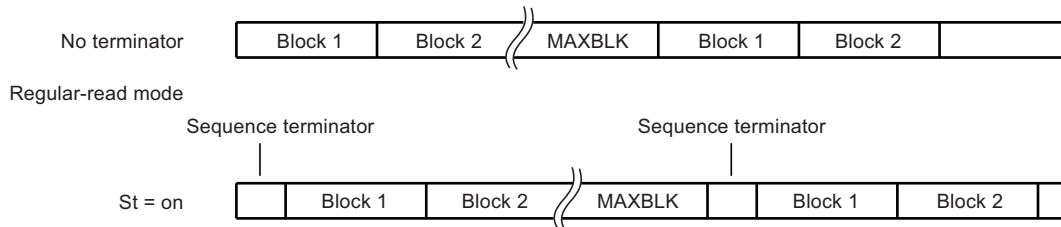
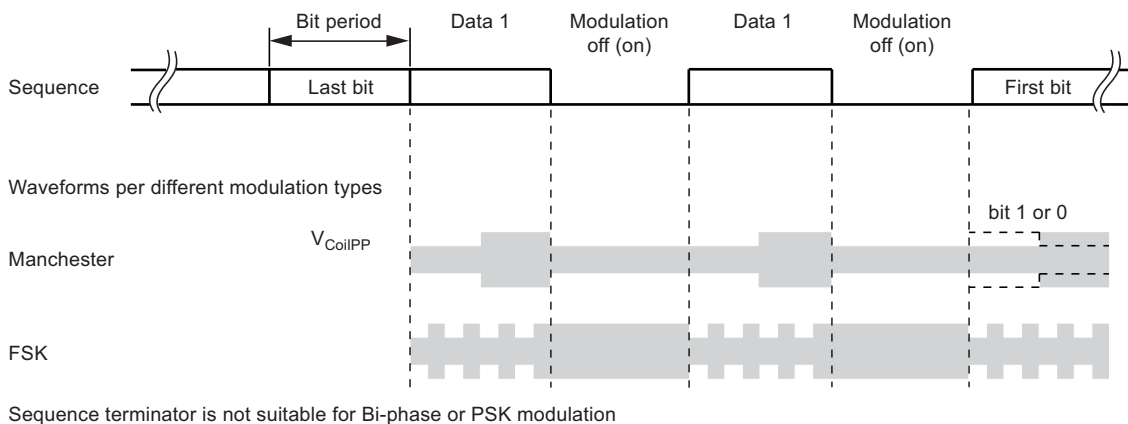

Figure 5-6. Basic Mode Sequence Terminator Waveforms



5.11.4 Sequence Start Marker (X-mode)

The Atmel® ATA5577C sequence start marker is a special damping pattern in extended mode which may be used to synchronize the reader. The sequence start marker consists of two bits ("01" or "10") which are inserted as a header before the first block to be transmitted if, in extended mode, bit 29 is set. At the start of a new block sequence, the value of the two bits is inverted.

Figure 5-7. Atmel ATA5577C Sequence Start Marker in Extended Mode

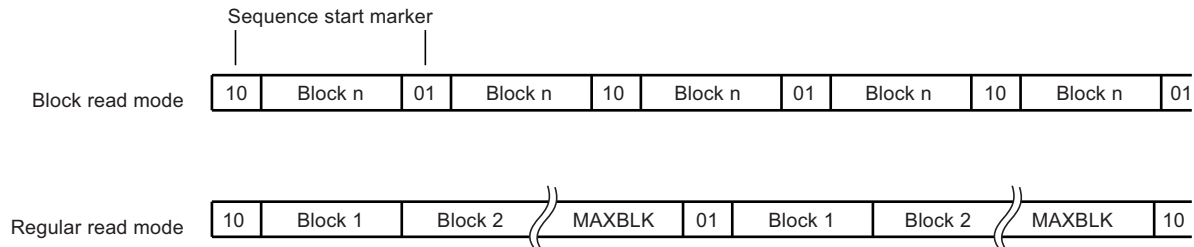

5.12 Reader to Tag Communication

Data is transmitted to the tag by interrupting the RF field with short field gaps (on-off keying) in accordance with the Atmel T5557/ATA5567 write method (downlink mode). The duration of these field gaps is, for example, 100µs. The time between two gaps encodes the 0/1 information to be transmitted (pulse interval encoding). There are four different downlink protocols available, which are selectable via bit 21 and bit 22 in the option register block 3, page 1 (see [Table 5-1 on page 8](#)).

Choosing the default downlink protocol (fixed-bit-length protocol), the time between two gaps is nominally 24 field clocks for a 0 and 56 field clocks for a 1. When there is no gap for more than 64 field clocks after a previous gap, the Atmel ATA5577C exits the downlink mode. The tag starts with the command execution if the correct number of bits were received. If a failure is detected, the Atmel ATA5577C does not continue and enters regular-read mode.

Improved downlink performance could be achieved by choosing self-calibrating downlink protocols. The Atmel ATA5577C offers three different possibilities to achieve better performance using self-calibrating downlink protocols.

- Long leading reference:
Fully forward and backward compatible with former tags and readers.
- Leading zero:
A reader has to send a leading zero in front of the downlink bit stream. This leading zero serves as a reference for the following zero and one bits.
- 1-of-4 coding:
Compact downlink protocol with optimized energy balance

5.12.1 Start Gap

The initial gap is referred to as the start gap. This triggers the reader-to-tag communication. In the option register (block 3, page 1), several settings can be chosen to ease gap detection during this mode of operation; for example, the receive damping can be activated (see [Table 5-1 on page 8](#)). The start gap may need to be longer than subsequent gaps — so-called write gaps — in order to be detected reliably.

A start gap will be accepted at any time after the mode register has been loaded (≥ 3 ms). A single gap will not change the previously selected page (by a previous opcode "10" or "11").

Figure 5-8. Start of Reader-to-tag Communication

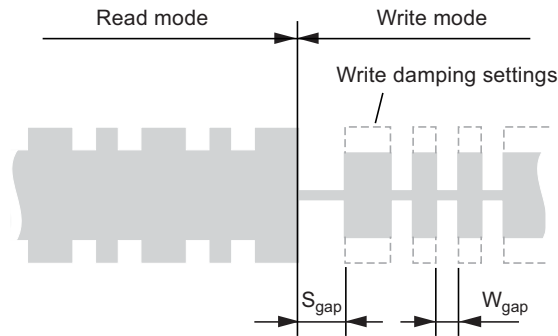

Table 5-9. Gap Scheme

Parameters	Remark	Symbol	Min.	Max.	Unit
Start gap		S_{gap}	8	50	T_C
Write gap	Normal downlink mode	W_{gap}	8	20	T_C

Note: All absolute times assume $T_C = 1 / f_C = 8\mu s$ ($f_C = 125kHz$)

5.12.2 Downlink Data Protocols

The Atmel® ATA5577C expects to receive a dual-bit opcode as a part of a reader command sequence. There are three valid opcodes:

- The opcode “10” precedes all downlink operations for page 0.
- The opcode “11” precedes all downlink operations for page 1. Performing a direct access command on block 0 always provides block 0 page 0 independently of the page selector (see [Figure 4-2 on page 6](#)).
- The RESET opcode “00” initiates an initialization cycle

The fourth opcode “01” precedes all test mode write operations. Any test mode access is ignored after master key (bits 1 to 4) in block 0 has been set to “6”. Any further modifications of the master key are prohibited by setting the lock bit of block 0 or the OTP bit.

Downlink has to follow these rules:

- Standard write needs the opcode, the lock bit, 32 data bits and the 3-bit address (38 bits total)
- Protected write (PWD bit set) requires a valid 32-bit password between the opcode and the data and address bits
Protected write (PWD bit set) in conjunction with the leading-zero-reference protocol or with the 1-of-4-coding protocol requires two padding zero bits between the opcode and the password (see also [Figure 5-17 on page 24](#)). This ensures the uniqueness of the direct access with password and the standard write command (see also [Table 6-1 on page 26](#)).
- For the AOR wake-up command an opcode and a valid password are necessary to select and activate a specific tag

Note: The data bits are read in the same order as written.

If the transmitted command sequence is invalid, the Atmel ATA5577C enters regular-read mode with the previously selected page (by previous opcode “10” or “11”).

Figure 5-9. Complete Writing Sequence with Fixed-bit-length Protocol

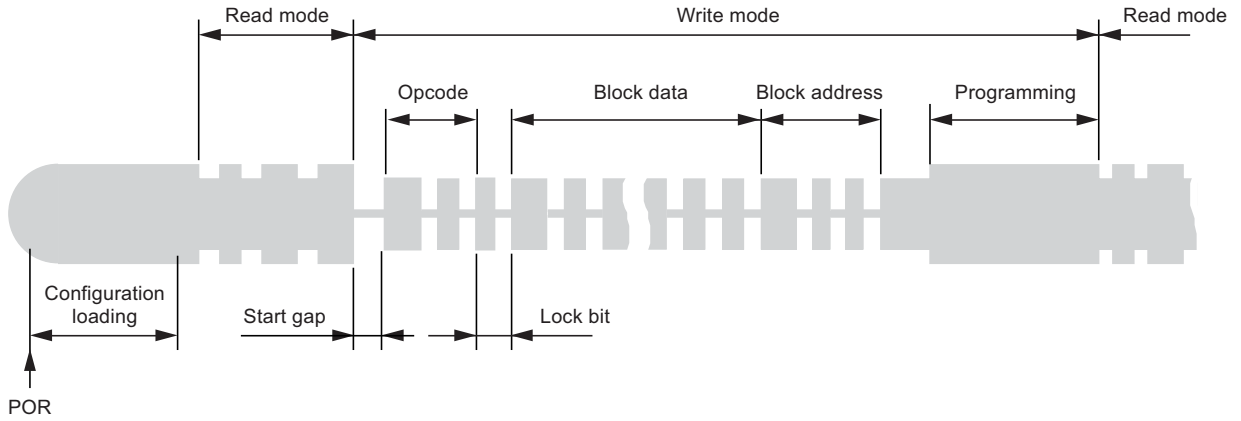

Figure 5-10. Atmel ATA5577C Command Formats Fixed-bit-length Protocol and Long-leading-reference Protocol

	Ref	OP								
Standard write	R**)	1p*)	L	1	Data	32	2	Addr	0	
Protected write	R**)	1p*)	1	Password	32	L	1	Data	32	2 Addr 0
AOR (wake-up command)	R**)	1p*)	1	Password	32					
Direct access (PWD = 1)	R**)	1p*)	1	Password	32	0	2	Addr	0	
Direct access (PWD = 0)	R**)	1p*)	0	2	Addr	0				
Page 0/1 regular read	R**)	1p*)								
Reset command	R**)	00								

*) p = page selector
**) R = Reference pulse if necessary

Figure 5-11. Atmel ATA5577C Command Formats Leading-zero-reference Protocol and 1-of-4-coding Protocol

	Ref	OP								
Standard write	R**)	1p*)	L	1	Data	32	2	Addr	0	
Protected write	R**)	1p*)	00	1	Password	32	L	1	Data	32 2 Addr 0
AOR (wake-up command)	R**)	1p*)	00	1	Password	32				
Direct access (PWD = 1)	R**)	1p*)	00	1	Password	32	0	2	Addr	0
Direct access (PWD = 0)	R**)	1p*)	0	2	Addr	0				
Page 0/1 regular read	R**)	1p*)								
Reset command	R**)	00								

*) p = page selector
**) R = Reference pulse

5.12.3 Fixed-bit-length Protocol

In the fixed-bit-length protocol, the time between two gaps is nominally 24 field clocks for a 0 and 56 field clocks for a 1. When there is no gap for more than 64 field clocks after a previous gap, the Atmel® ATA5577C exits the downlink mode. This protocol is compatible with the Atmel T5557/ATA5567 transponder.

Table 5-10. Downlink Data Coding Scheme with Fixed-bit-length Protocol

Parameter	Remark	Symbol	Normal Downlink			Fast Downlink			Unit
			Min.	Typ.	Max.	Min.	Typ.	Max.	
Start gap		S_{gap}	8	15	50	8	15	50	T_c
Write gap		W_{gap}	8	10	20	8	10	20	T_c
Write data coding (gap separation)	0 data	d_0	16	24	32	8	12	16	T_c
	1 data	d_1	48	56	64	24	28	32	T_c

Note: All absolute times assume $T_c = 1 / f_c = 8\mu s$ ($f_c = 125kHz$)

Figure 5-12. Fixed-bit-length Protocol



5.12.4 Long-leading-reference Protocol

To achieve better downlink performance, an enhanced Atmel ATA5577C reader places a reference pulse in front of the opcode. This reference pulse is used as a timing reference for all following data, thus providing an auto-adjustment for varying environmental conditions. The long-leading-reference protocol allows full compatibility and coexistence of both Atmel T5557/ATA5567 and Atmel ATA5577C devices with both Atmel T5557/ATA5567 compatible readers and advanced Atmel ATA5577C readers. However, only the Atmel ATA5577C devices can profit from the self calibration and the resultant increase in write distance (see [Table 5-1 on page 8](#) for option register settings).

In this mode, the reference pulse in front of the command is monitored. Depending on the pulse length, the remainder of the command is either evaluated using the fixed-bit-length protocol, or is used as a measurement reference to evaluate the following command bits. Otherwise, the following bits are considered as an invalid command.

a) For a reference-based command, the reference pulse (dRef) will have a length of $16 + 32 + 136 = 152$ to 168 field clocks (zero bit + timing bias = reference pulse). Hence, the expected length will lie between 152 and 168 field clocks. The equivalent expected zero-bit length is then extracted and used as a reference for all following bits. The long-leading-reference pulse in this case is used as a timing reference only, and does not contribute to the command data itself (see [Figure 5-13, part a on 21](#)).

b) Should the first bit lie within the fixed-bit-length frame (for example, in normal mode: 0: 16 to 32 clocks; 1: 48 to 64 clocks), the device will then automatically switch to the fixed-bit-length protocol (see [Section 5.12.3 “Fixed-bit-length Protocol” on page 20](#)) and this first pulse will be evaluated as the first command bit. This allows compatibility with long-leading-reference programmed Atmel ATA5577C devices interacting with Atmel T5557/ATA5567 readers, which do not send any reference pulses (see [Figure 5-13, part b on 21](#)).

c) If an Atmel T5557/ATA5567 device interacts with an enhanced Atmel ATA5577C reader, the reference pulse (152 to 168 field clocks) is ignored by the Atmel T5557/ATA5567 and the following data bits will be evaluated correctly. Therefore, an Atmel T5557/ATA5567 device is compatible with an enhanced Atmel ATA5577C reader (see [Figure 5-13, part b on 21](#)).

d) Should the first bit correspond to neither (a) nor (b) then it will be rejected as an invalid command.

Table 5-11. Downlink Data Coding Scheme with Long Leading Reference

Parameter	Remark	Symbol	Normal Downlink			Fast Downlink			Unit
			Min.	Typ.	Max.	Min.	Typ.	Max.	
Start gap		S_{gap}	8	15	50	8	15	50	T_c
Write gap		W_{gap}	8	10	20	8	10	20	T_c
Write data coding (gap separation)	Reference Pulse	d_{ref}	152	160	168	140	144	148	T_c
			136 clocks + 0 data bit			132 clocks + 0 data bit			T_c
	0 data	d_0	$d_{ref} - 143$	$d_{ref} - 136$	$d_{ref} - 128$	$d_{ref} - 135$	$d_{ref} - 132$	$d_{ref} - 124$	T_c
	1 data	d_1	$d_{ref} - 111$	$d_{ref} - 104$	$d_{ref} - 96$	$d_{ref} - 119$	$d_{ref} - 116$	$d_{ref} - 112$	T_c

Note: All absolute times assume $T_c = 1 / f_c = 8\mu s$ ($f_c = 125kHz$)

Figure 5-13. Long-leading-reference Protocol

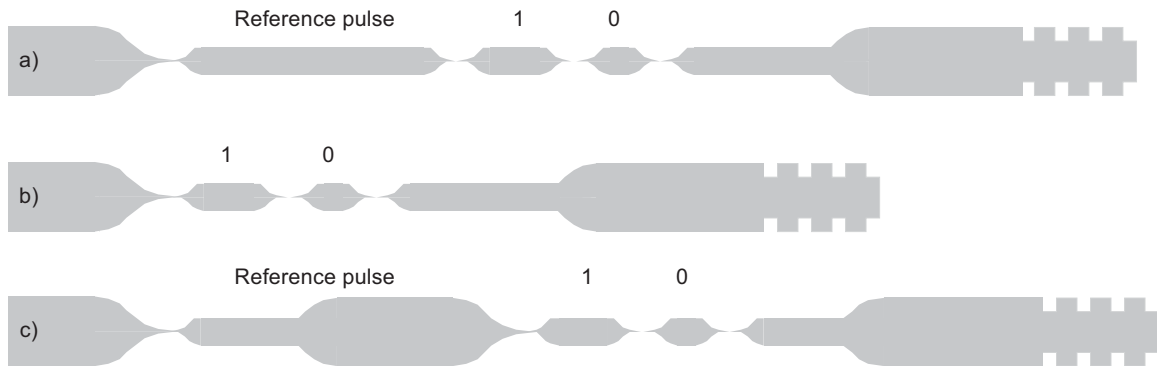

5.12.5 Leading-zero-reference Protocol

If the device is programmed in this mode, it will always expect a reference pulse before the command data itself. This pulse length should correspond exactly to the length of the zero bits in the following command. All further lengths of the zero and one bits of the command are derived from the reference pulse. Therefore, downlink performance is optimal in different environmental conditions.

Table 5-12. Downlink Data Coding Scheme with Leading-zero Reference

Parameter	Remark	Symbol	Normal Downlink			Fast Downlink			Unit
			Min.	Typ.	Max.	Min.	Typ.	Max.	
Start gap		S_{gap}	8	15	50	8	15	50	T_c
Write gap		W_{gap}	8	10	20	8	10	20	T_c
Write data coding (gap separation)	Reference Pulse	d_{ref}	12	–	72	8	–	68	T_c
	0 data	d_0	$d_{ref} - 7$	d_{ref}	$d_{ref} + 8$	$d_{ref} - 3$	d_{ref}	$d_{ref} + 4$	T_c
	1 data	d_1	$d_{ref} + 9$	$d_{ref} + 16$	$d_{ref} + 24$	$d_{ref} + 5$	$d_{ref} + 8$	$d_{ref} + 12$	T_c

Note: All absolute times assume $T_c = 1 / f_c = 8\mu s$ ($f_c = 125kHz$)

Figure 5-14. Leading-zero-reference Protocol

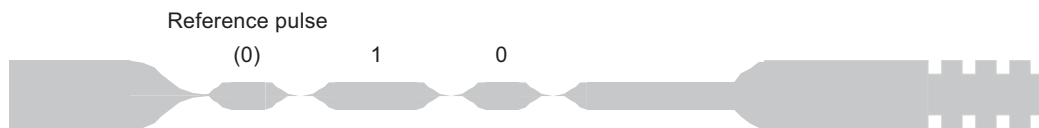

5.12.6 1-of-4-coding Protocol

This protocol codes the data in bit pairs so that the length of each packet can have one of four discrete lengths. This protocol is extremely compact and exhibits the least number of field gaps, which in turn improves the device's ability to extract power from the field. Additionally, a leading reference pulse “00” is placed in front of the downlink command. This serves as a reference pulse for all following data bits, thus providing an auto-adjustment for varying environmental conditions.

Table 5-13. Downlink Data Coding Scheme with 1-of-4 Coding

Parameter	Remark	Symbol	Normal Downlink			Fast Downlink			Unit
			Min.	Typ.	Max.	Min.	Typ.	Max.	
Start gap		S_{gap}	8	15	50	8	15	50	T_c
Write gap		W_{gap}	8	10	20	8	10	20	T_c
Write data coding (gap separation)	Reference pulse “00”	d_{ref}	12	–	72	8	–	68	T_c
	“00” data	d_{00}	$d_{\text{ref}} - 7$	d_{ref}	$d_{\text{ref}} + 8$	$d_{\text{ref}} - 3$	d_{ref}	$d_{\text{ref}} + 4$	T_c
	“01” data	d_{01}	$d_{\text{ref}} + 9$	$d_{\text{ref}} + 16$	$d_{\text{ref}} + 24$	$d_{\text{ref}} + 5$	$d_{\text{ref}} + 8$	$d_{\text{ref}} + 12$	T_c
	“10” data	d_{10}	$d_{\text{ref}} + 25$	$d_{\text{ref}} + 32$	$d_{\text{ref}} + 40$	$d_{\text{ref}} + 13$	$d_{\text{ref}} + 16$	$d_{\text{ref}} + 20$	T_c
	“11” data	d_{11}	$d_{\text{ref}} + 41$	$d_{\text{ref}} + 48$	$d_{\text{ref}} + 56$	$d_{\text{ref}} + 21$	$d_{\text{ref}} + 24$	$d_{\text{ref}} + 28$	T_c

Note: All absolute times assume $T_c = 1 / f_c = 8\mu\text{s}$ ($f_c = 125\text{kHz}$)

Figure 5-15. 1-of-4-coding Protocol

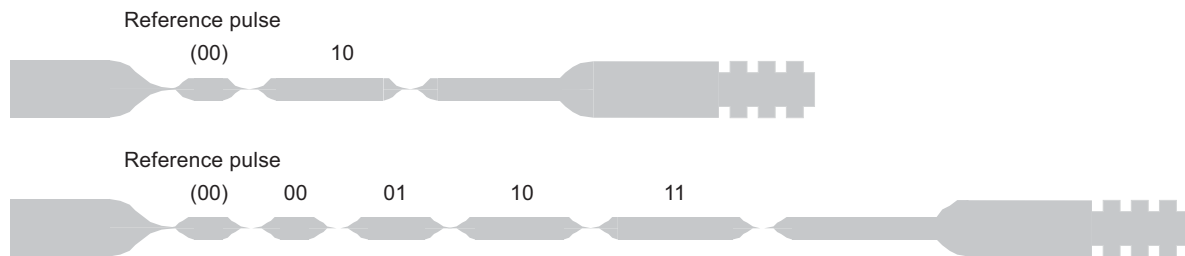
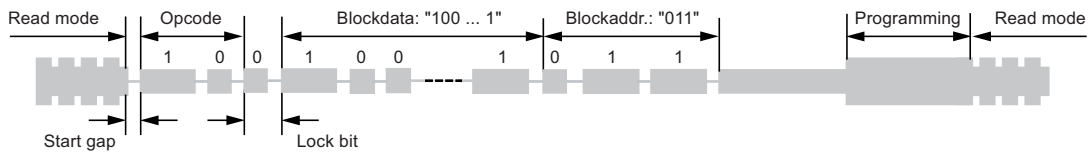
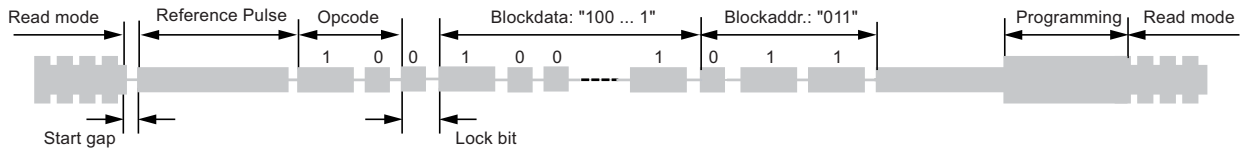

Figure 5-16. Standard Write Sequence Example

a) Fixed-bit-length Protocol



b) Long-leading-reference Protocol



c) Leading-zero-reference Protocol

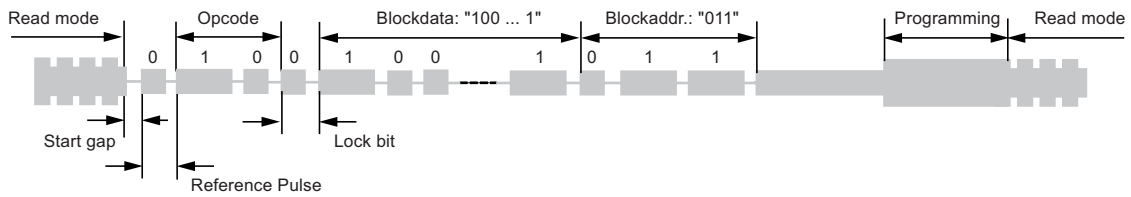

d) 1-of-4-coding Protocol

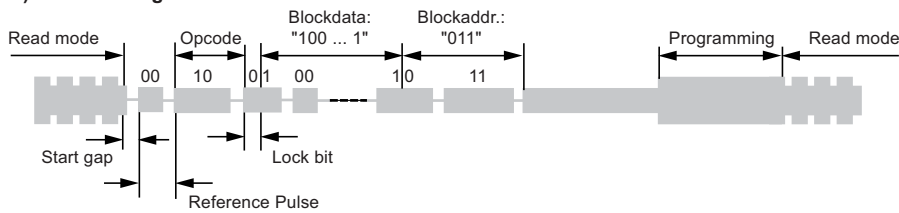
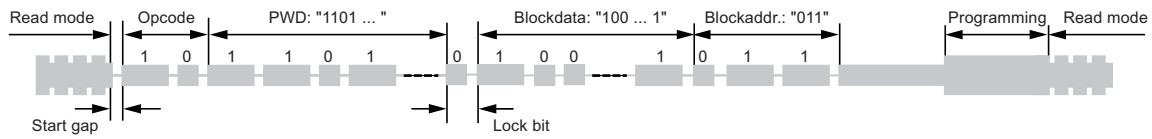
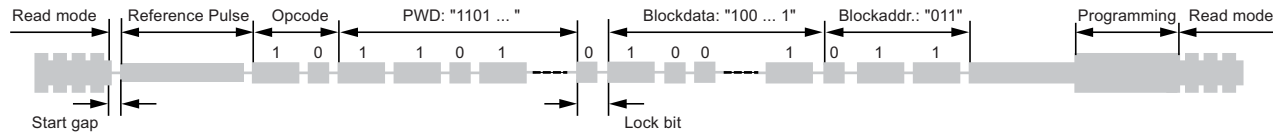

Figure 5-17. Protected Write Sequence Example

a) Fixed-bit-length Protocol



b) Long-leading-reference Protocol



c) Leading-zero-reference Protocol

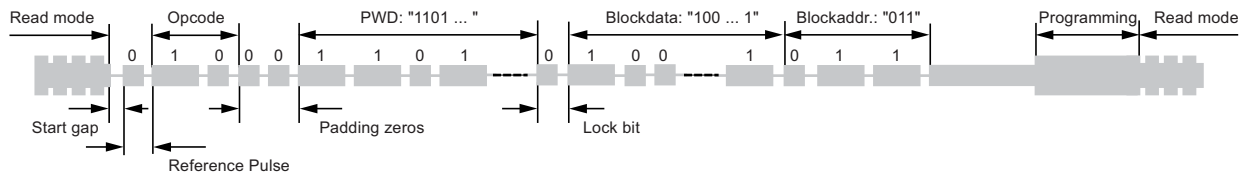

d) 1-of-4-coding Protocol

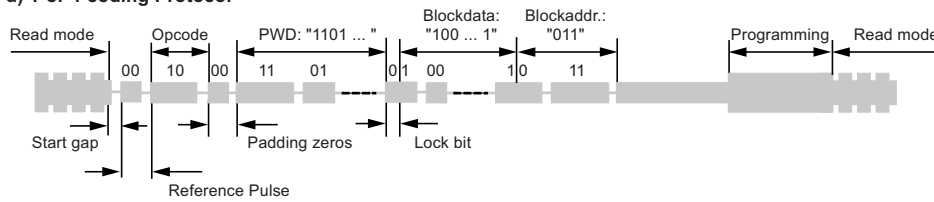

5.13 Programming

When all necessary information has been received by the Atmel® ATA5577C, programming may proceed. There is a clock delay between the end of the writing sequence and the start of programming.

Typical programming time is 5.6ms. This cycle includes a data verification read to grant secure and correct programming. After programming is successfully executed, the Atmel ATA5577C enters block-read mode, transmitting the block just programmed (see [Figure 5-18 on page 25](#)).

Note: This timing and behavior is different from that of the Atmel e55x-family predecessors. For further details, refer to relevant Atmel application notes.

If the command sequence is validated and the addressed block is not write protected, the new data will be programmed into the EEPROM memory. The new state of the block write protection bit (lock bit) will be programmed at the same time accordingly.

Each programming cycle consists of four consecutive steps: erase block, erase verification (data = 0), programming, and write verification (corresponding data bits = 1).

Figure 5-18. Coil Voltage after Programming a Memory Block

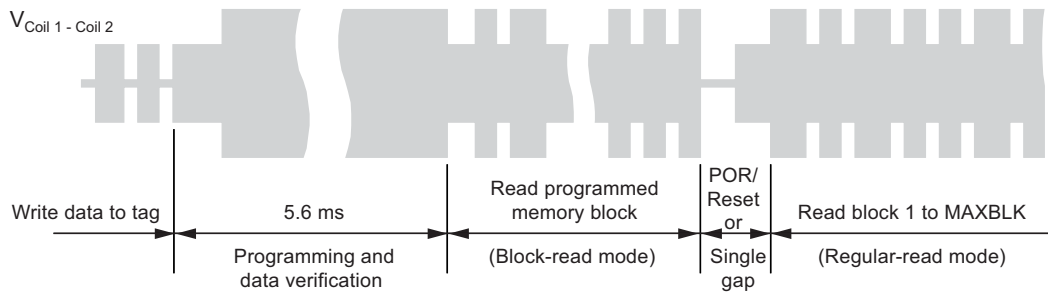

- Notes: 1. Programming of page 1 with following single gap will lead to a page 1 read. To enter regular-read mode, a POR or Reset command has to be performed.

6. Error Handling

Several error conditions can be detected to ensure that only valid bits are programmed into the EEPROM. There are two error types, which lead to two different actions.

6.1 Errors During Command Sequence

The following detectable errors could occur while sending a command sequence to the Atmel® ATA5577C:

- Wrong number of field clocks between two gaps (that is, not a valid 1 or 0 pulse stream)
- Password mode is activated and the password does not match the contents of block 7
- The number of bits received in the command sequence is incorrect

Valid bit counts accepted by the Atmel ATA5577C are listed in the following table.

Table 6-1. Bit Counts of Command Sequences

Command	Protect	Fixed-bit-length Protocol	Long-leading-reference Protocol	Leading-zero-reference Protocol	1-of-4-coding Protocol
Standard write	(PWD = 0)	38 bits	38 bits	38 bits	38 bits
Direct access	(PWD = 0)	6 bits	6 bits	6 bits	6 bits
Password write	(PWD = 1)	70 bits	70 bits	72 bits	72 bits
Direct access with PWD	(PWD = 1)	38 bits	38 bits	40 bits	40 bits
AOR wake up	(PWD = 1)	34 bits	34 bits	36 bits	36 bits
Reset command		2 bits	2 bits	2 bits	2 bits
Page 0/1 regular read		2 bits	2 bits	2 bits	2 bits

If any of these erroneous conditions (except AOR mode) are detected, the Atmel ATA5577C enters regular-read mode, starting with block 1 of the page defined in the command sequence. An erroneous AOR wake-up command will stop modulation (modulation defeat).

6.2 Errors Before/During Programming the EEPROM

If the command sequence was received successfully, the following error could still prevent programming:

- The lock bit of the addressed block is already set
- In case of a locked block, programming mode will not be entered. The Atmel® ATA5577C reverts to block-read mode continuously transmitting the currently addressed block
- If a data verification error is detected after an executed data block programming, the tag will stop modulation (modulation defeat) until a new command is transmitted.

Figure 6-1. Atmel ATA5577C Functional Diagram

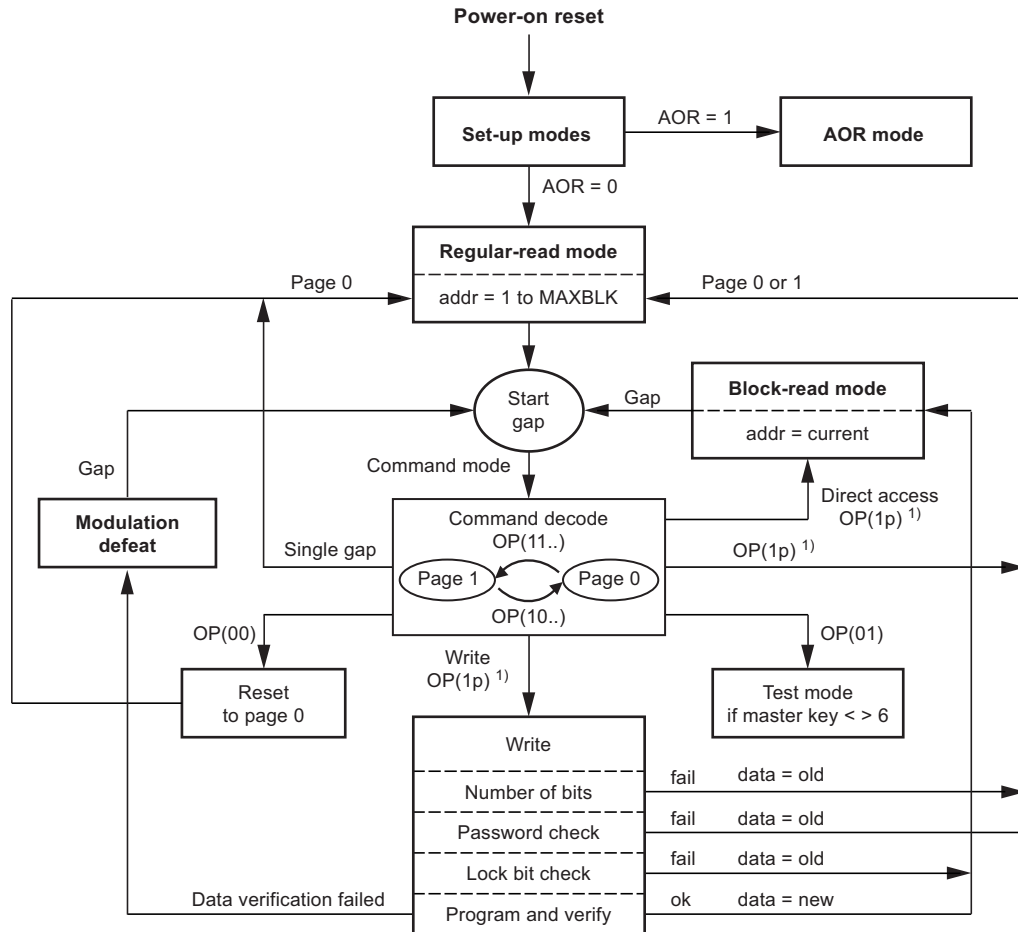

¹⁾ p = page selector

Figure 6-2. Example with Manchester Coding with Data Rate RF/16

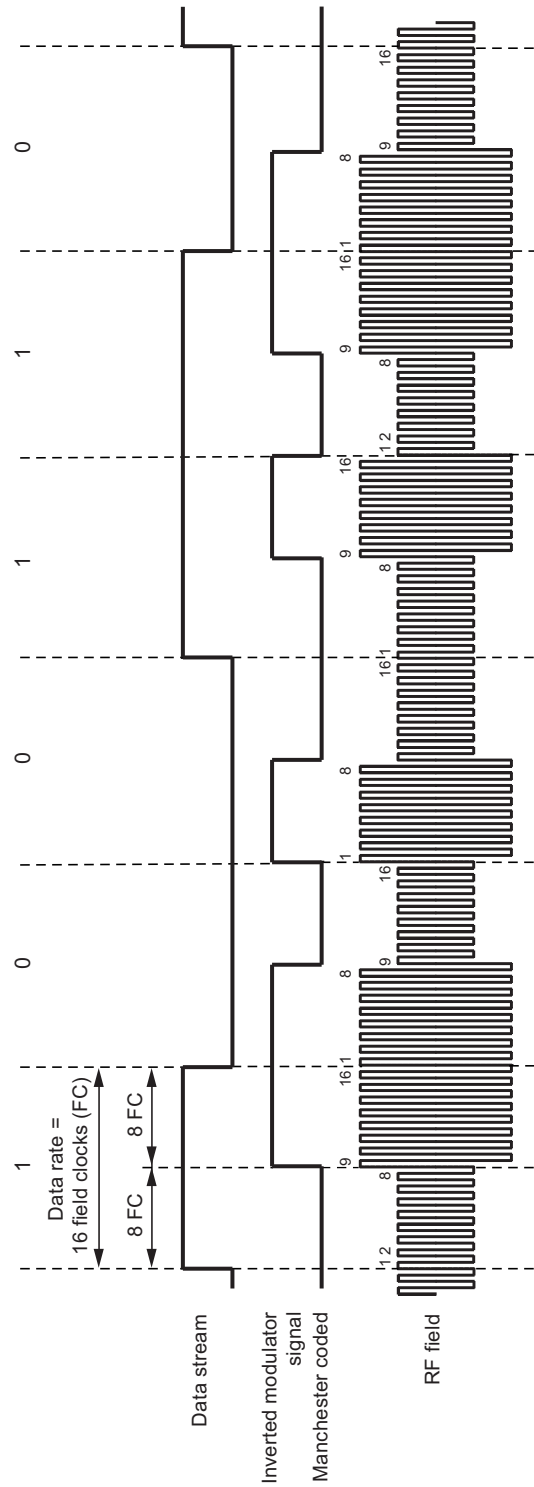

Figure 6-3. Example of Bi-phase Coding with Data Rate RF/16

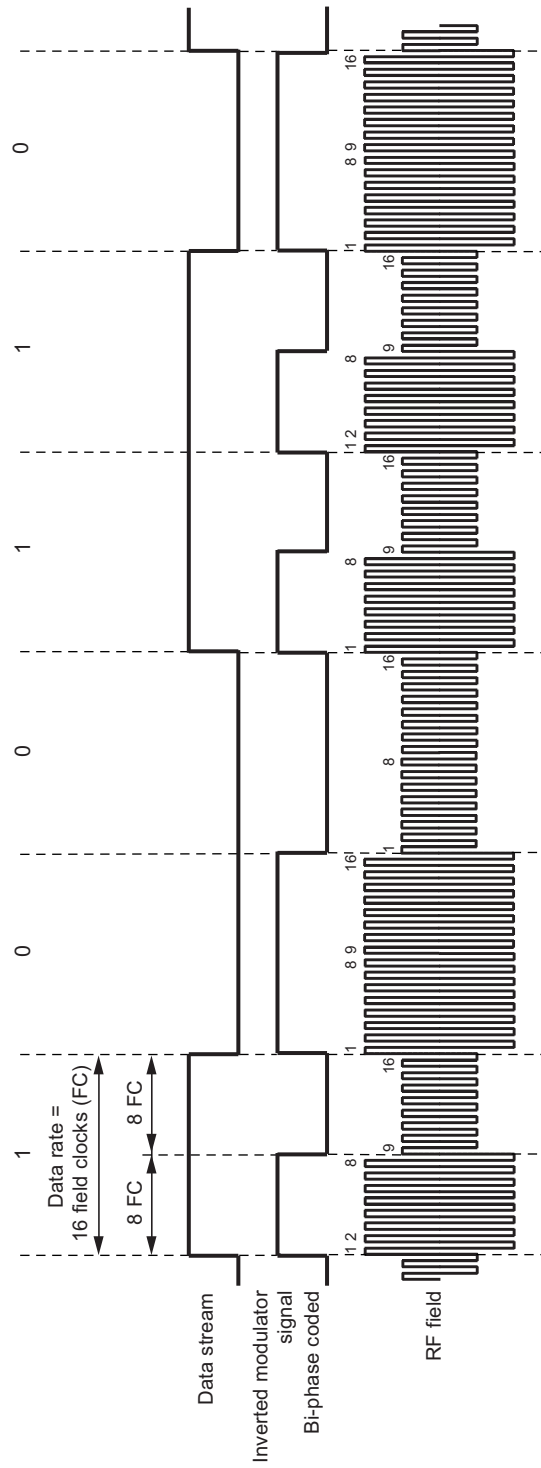

Figure 6-4. Example: FSK1a Coding with Data Rate $RF/40$, Sub-carrier $f_0 = RF/8$, $f_1 = RF/5$

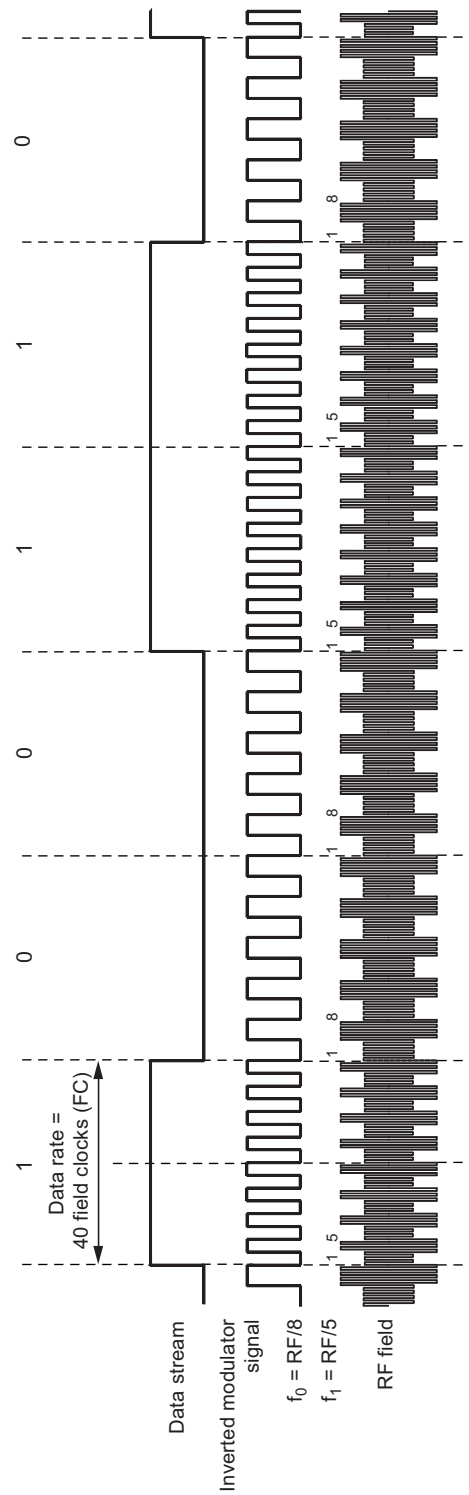

Figure 6-5. Example of PSK1 Coding with Data Rate $R_F/16$

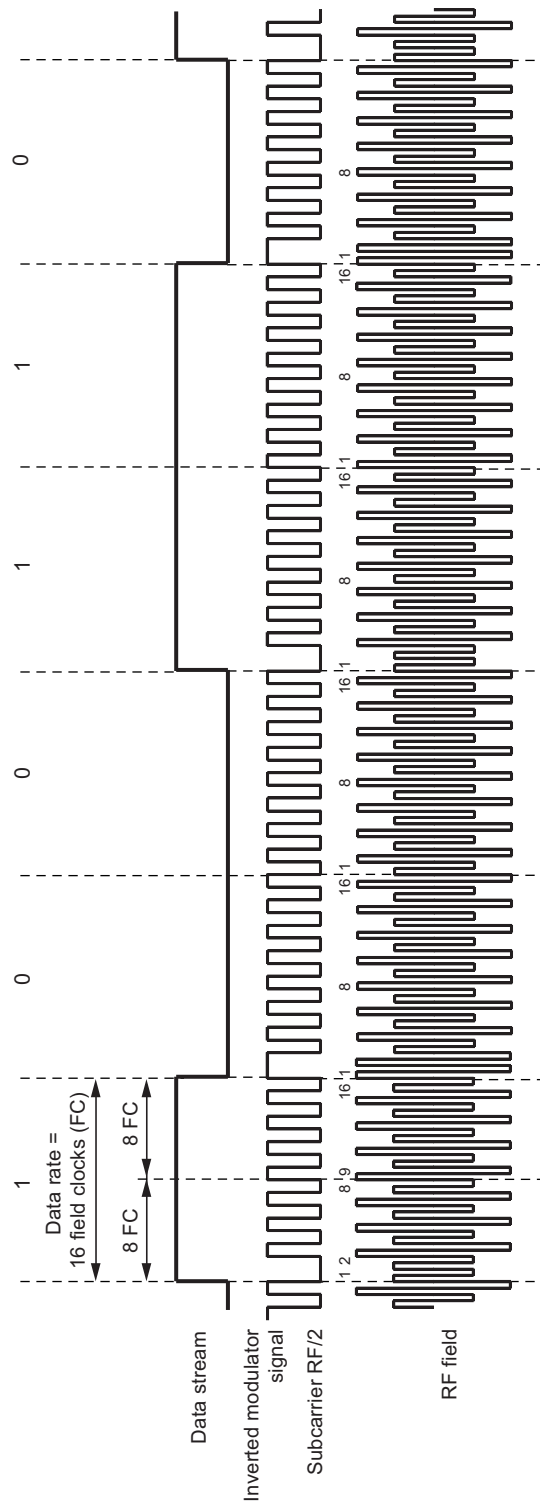

Figure 6-6. Example of PSK2 Coding with Data Rate RF/16

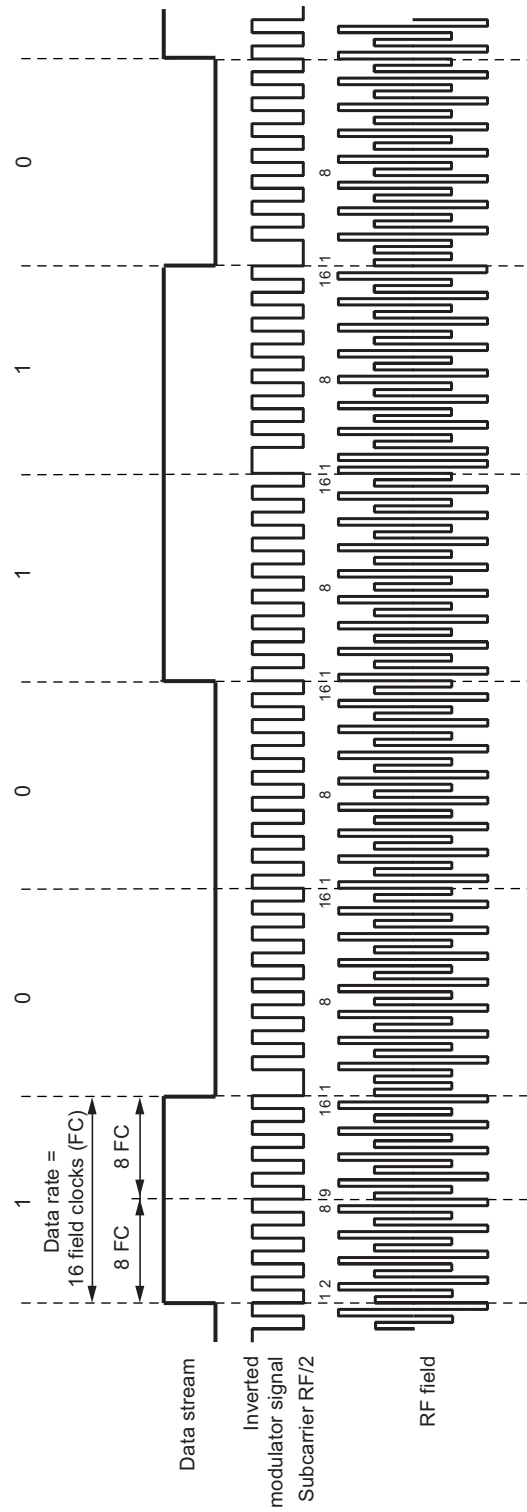
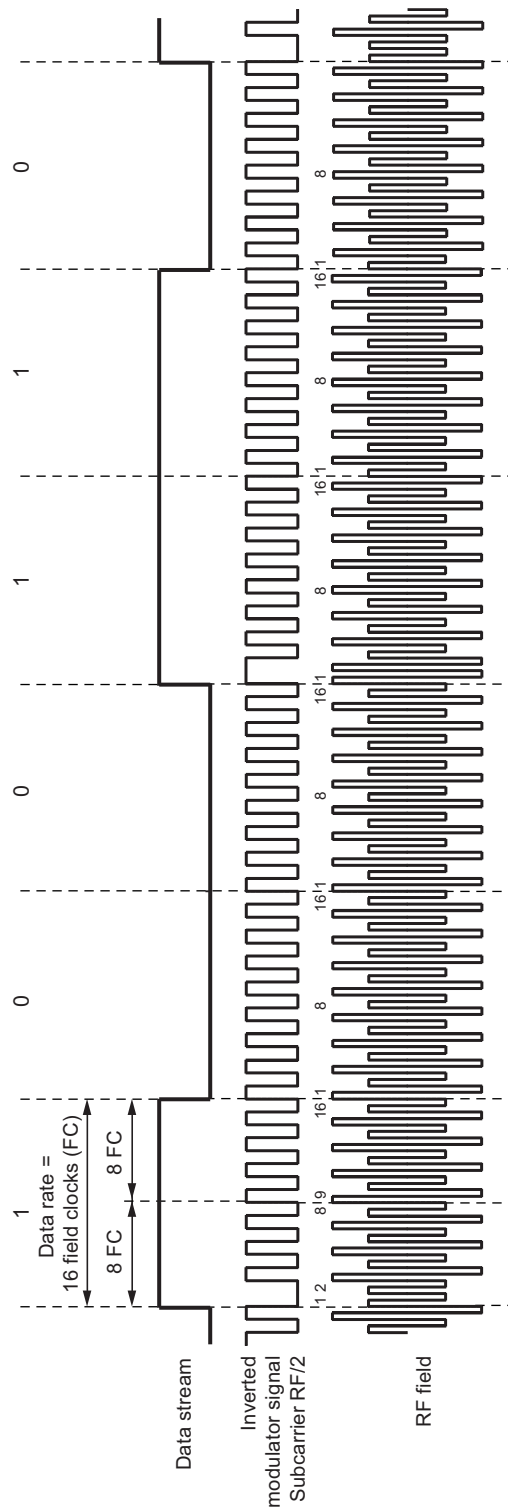

Figure 6-7. Example of PSK3 Coding with Data Rate $RF/16$



7. Animal ID

In ISO11784/11785, the code structure of a 128-bit FDX-B telegram is defined. Following is an example of how to program the Atmel ATA5577C for ISO 11785 FDX-B.

Figure 7-1. Structure of the ISO 11785 FDX-B Telegram

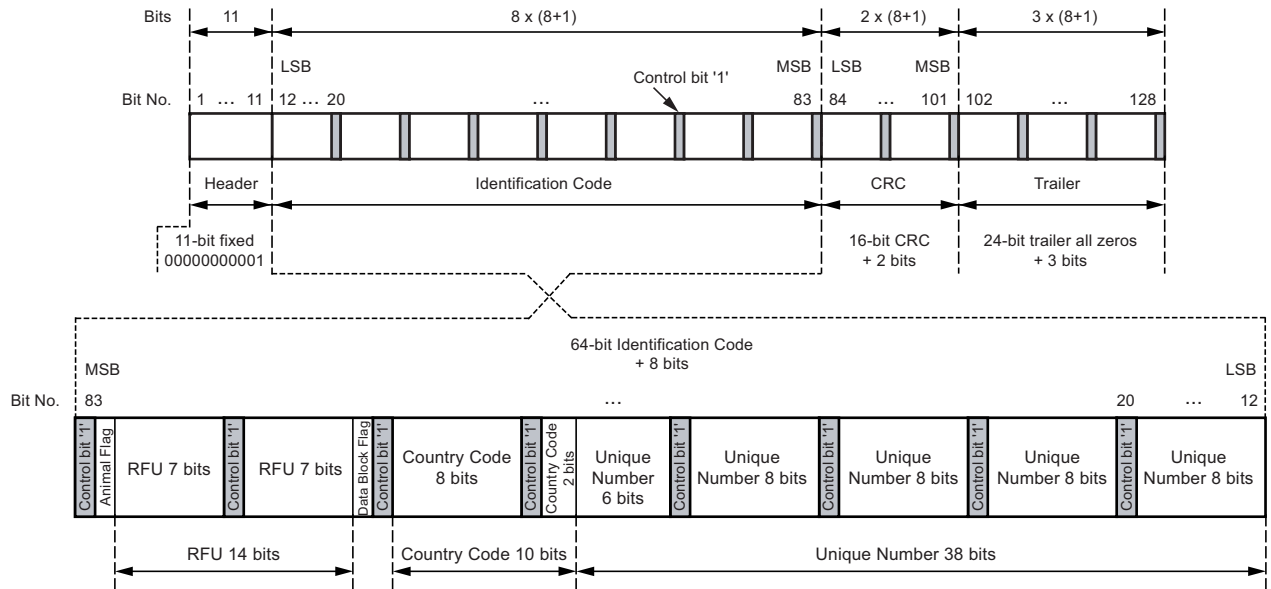

- Notes:
1. Except for the header, every eight bits are followed by one control bit (1), to prevent the header from recurring.
 2. All data is transmitted LSB first.
 3. Country codes are defined in ISO 3166
 4. The bits reserved for future use (RFU) are all set to 0.
 5. If the data block flag is not set, the trailer bits are all set to 0.
 6. CRC is performed on the 64-bit identification code without the control bits. The generator polynomial is $P(x) = x^{16} + x^{12} + x^5 + 1$. Reverse CRC-CCITT (0x 8 408) is used. Data stream is LSB first.

Table 7-1. Example Data for Animal ID

Code	Dec. Value	Hex. Value	Comment
Animal flag	1	1	Use for animal ID
RFU	0	0	Reserved for future use
Data block flag	0	0	No data in trailer
Country code	999	3E7	Country code for demo tags
Unique number	78187493530	123456789A	Any demo number
CRC	36255	8D9F	CRC for the identification code

Programming of the Atmel® ATA5577C for animal ID:

- Encoding of the data is differential bi-phase RF/32
- 128 bits have to be transmitted in regular-read mode (Maxblock = 4)

Table 7-2. Programming the Atmel ATA5577C with Example Data

Block	Address	Value	Comment
Option register	Block 3, page 1	0x 6DD0 0000 ⁽¹⁾	Soft modulation, two pulses recommended
Configuration register	Block 0, page 0	0x 603F 8080	RF/32, differential bi-phase, Maxblock = 4
User data block 1	Block 1, page 0	0x 002B 31EB	Header, unique number
User data block 2	Block 2, page 0	0x 54B2 979F	Unique number (cont.), country code
User data block 3	Block 3, page 0	0x 8040 7F3B	Data block flag, RFU, animal flag, CRC
User data block 4	Block 4, page 0	0x 1804 0201	CRC (cont.), trailer bits

Note: 1. Depending on application, settings may vary

8. Absolute Maximum Ratings

Stresses beyond those listed under “Absolute Maximum Ratings” may cause permanent damage to the device. This is a stress rating only and functional operation of the device at these or any other conditions beyond those indicated in the operational sections of this specification is not implied. Exposure to absolute maximum rating conditions for extended periods may affect device reliability.

Parameters	Symbol	Value	Unit
Maximum DC current into Coil1/Coil2	I_{coil}	20	mA
Maximum AC current into Coil1/Coil2, $f = 125\text{kHz}$	$I_{coil p}$	20	mA
Power dissipation (die) (free-air condition, time of application: 1s)	P_{tot}	100	mW
Electrostatic discharge maximum to ANSI/ESD-STM5.1-2001 standard (HBM)	V_{max}	3000	V
Operating ambient temperature range	T_{amb}	-40 to +85	°C
Storage temperature range (data retention reduced)	T_{stg}	-40 to +150	°C

9. Electrical Characteristics

$T_{amb} = +25^{\circ}\text{C}$; $f_{coil} = 125\text{kHz}$; unless otherwise specified

No.	Parameters	Test Conditions	Symbol	Min.	Typ.	Max.	Unit	Type*
1	RF frequency range		f_{RF}	100	125	150	kHz	
2.1	Supply current (without current consumed by the external LC tank circuit)	$T_{amb} = 25^{\circ}\text{C}^{(1)}$	I_{DD}		1.5	3	μA	T
2.2		Read - full temperature range			2	5	μA	Q
2.3		Programming - full temperature range			25		μA	Q
3.1	Coil voltage (AC supply)	POR threshold (50-mV hysteresis)	$V_{coil pp}$		3.6		V	Q
3.2		Read mode and write command ⁽²⁾		6		V_{clamp}	V	Q
3.3		Program EEPROM ⁽²⁾		8		V_{clamp}	V	Q
4	Start-up time	$V_{coil pp} = 6\text{V}$	$t_{startup}$		2.5		ms	Q
5.1	Clamp voltage (depends on settings in option register)	3-mA current into Coil1/Coil2	$V_{pp clamp lo}$		11		V	Q
5.2			$V_{pp clamp med}$		13		V	Q
5.3			$V_{pp clamp hi}$	14	17	21	V	T
5.4			20-mA current into Coil1/Coil2	$V_{pp clamp med}$	13	15	18	V

*) Type means: T: directly or indirectly tested during production; Q: guaranteed based on initial product qualification data

- Notes:
- I_{DD} measurement set-up: EEPROM programmed to 00 ... 000 (erase all); chip in modulation defeat.
 - Current into Coil1/Coil2 is limited to 10mA.
 - Since EEPROM performance is influenced by assembly processes, Atmel cannot confirm the parameters for -DDW (tested die on unsawn wafer) delivery.
 - See [Section 10. “Ordering Information” on page 38](#).

9. Electrical Characteristics (Continued)

$T_{amb} = +25^{\circ}\text{C}$; $f_{coil} = 125\text{kHz}$; unless otherwise specified

No.	Parameters	Test Conditions	Symbol	Min.	Typ.	Max.	Unit	Type*		
6.1	Modulation parameters (depends on settings in option register)	3-mA current into Coil1/Coil2 and modulation ON	$V_{pp\ mod\ lo}$	2	3	4	V	T		
6.2			$V_{pp\ mod\ med}$		5		V	Q		
6.3			$V_{pp\ mod\ hi}$		7		V	Q		
6.4		20-mA current into Coil1/Coil2 and modulation ON	$V_{pp\ mod\ med}$	6	7.5	9	V	T		
6.5	Thermal stability		$\frac{V_{mod\ lo}}{T_{amb}}$		-1		mV/ $^{\circ}\text{C}$	Q		
7.1	Clock detection level (depends on settings in option register)	$V_{coil\ pp} = 8\text{V}$	$V_{clkdet\ lo}$		250		mV	Q		
7.2			$V_{clkdet\ med}$	400	550	730	mV	T		
7.3			$V_{clkdet\ hi}$		800		mV	Q		
7.4	Gap detection level (depends on settings in option register)	$V_{coil\ pp} = 8\text{V}$	$V_{gapdet\ lo}$		250		mV	Q		
7.5			$V_{gapdet\ med}$	400	550	730	mV	T		
7.6			$V_{gapdet\ hi}$		850		mV	Q		
8	Programming time	From last command gap to re-enter read mode (64 + 648 internal clocks)	T_{prog}	5	5.7	6	ms	T		
9	Endurance	Erase all/Write all ⁽³⁾	n_{cycle}	100000			Cycles	Q		
10.1	Data retention	Top = 55°C ⁽³⁾	$t_{retention}$	10	20	50	Years	Q		
10.2		Top = 150°C ⁽³⁾	$t_{retention}$	96			hrs	T		
10.3		Top = 250°C ⁽³⁾	$t_{retention}$	24			hrs	Q		
11.1	Resonance capacitor	Mask option ⁽⁴⁾	C_r		320	330	340	pF	T	
11.2					242	250	258			
11.3						130				
11.4						75				
11.5						10				Q
12.1	Micromodule capacitor parameters ⁽⁴⁾	Capacitance tolerance T_{amb}	C_r	320	330	340	pF	T		

*) Type means: T: directly or indirectly tested during production; Q: guaranteed based on initial product qualification data

- Notes:
- I_{DD} measurement set-up: EEPROM programmed to 00 ... 000 (erase all); chip in modulation defeat.
 - Current into Coil1/Coil2 is limited to 10mA.
 - Since EEPROM performance is influenced by assembly processes, Atmel cannot confirm the parameters for -DDW (tested die on unsawn wafer) delivery.
 - See [Section 10. "Ordering Information" on page 38.](#)

10.1 Available Order Codes

ATA5577M1330C-DDB
ATA5577M1330C-DDW
ATA5577M1330C-PAE
ATA5577M1330C-UFQW
ATA5577M1330C-PPMY
ATA5577M133SC-DDB
ATA5577M2330C-DBB
ATA5577M2330C-DBQ
ATA5577M233AC-DBB
ATA5577M233SC-DBB

New order codes will be created by customer request if order quantities are over 250k pieces.

10.2 Configuration on Delivery

Table 10-1. Configuration on Delivery

Block	Address	Value	Comment
AFE option set up	Block 3, page 1	0x 0000 0000	All option take on the default state
Configregister	Block 0, page 0	0x 0008 8040	RF/32, Manchester, Maxblock = 2
User data block 1	Block 1, page 0	0x 0000 0000	All "0"
User data block 2	Block 2, page 0	0x 0000 0000	All "0"

Figure 11-2. Sawn Wafer on Foil with Ring (Type 2, Mega Pads and Au Bumps)

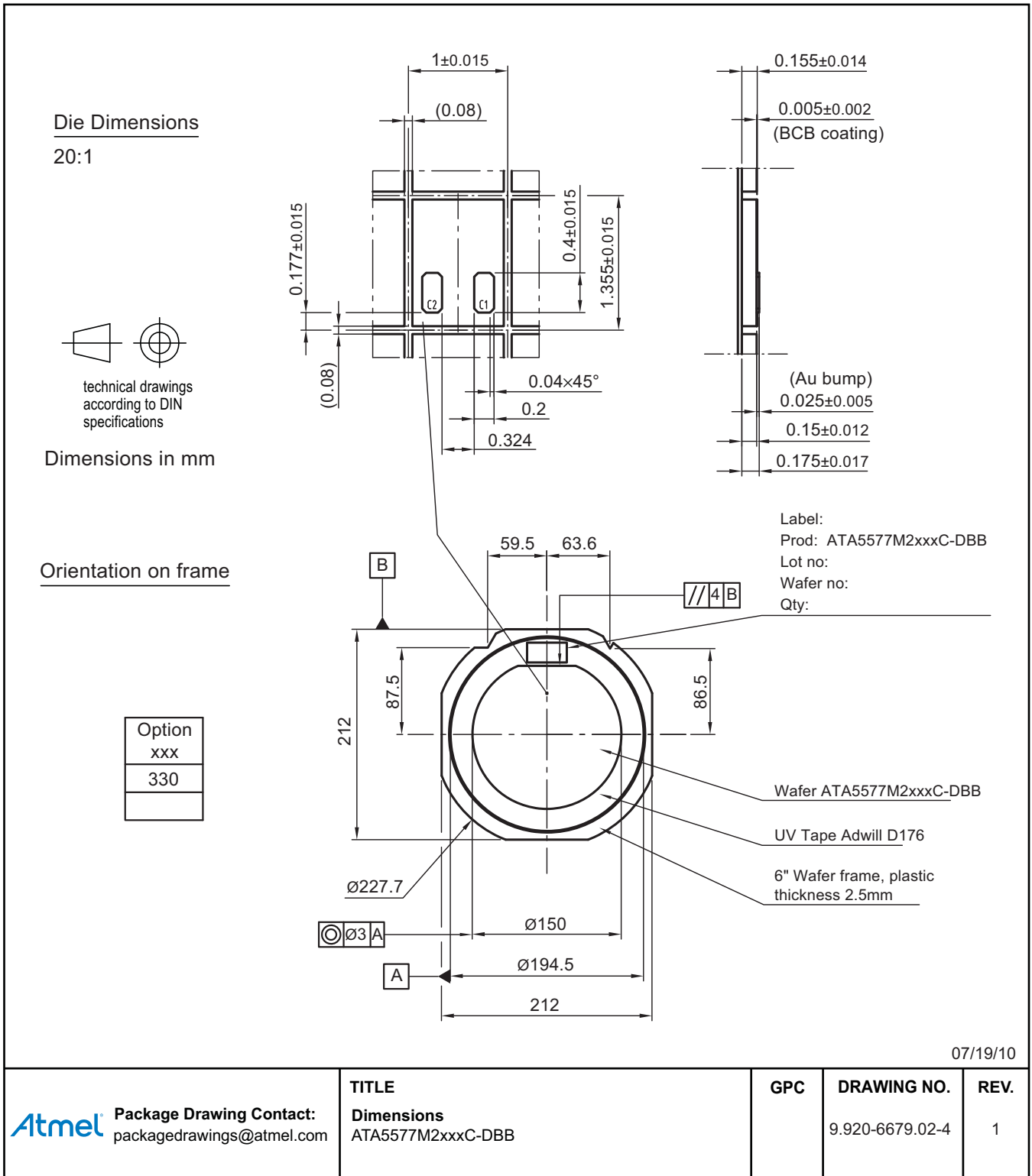

Figure 11-3. Die in Blister Tape

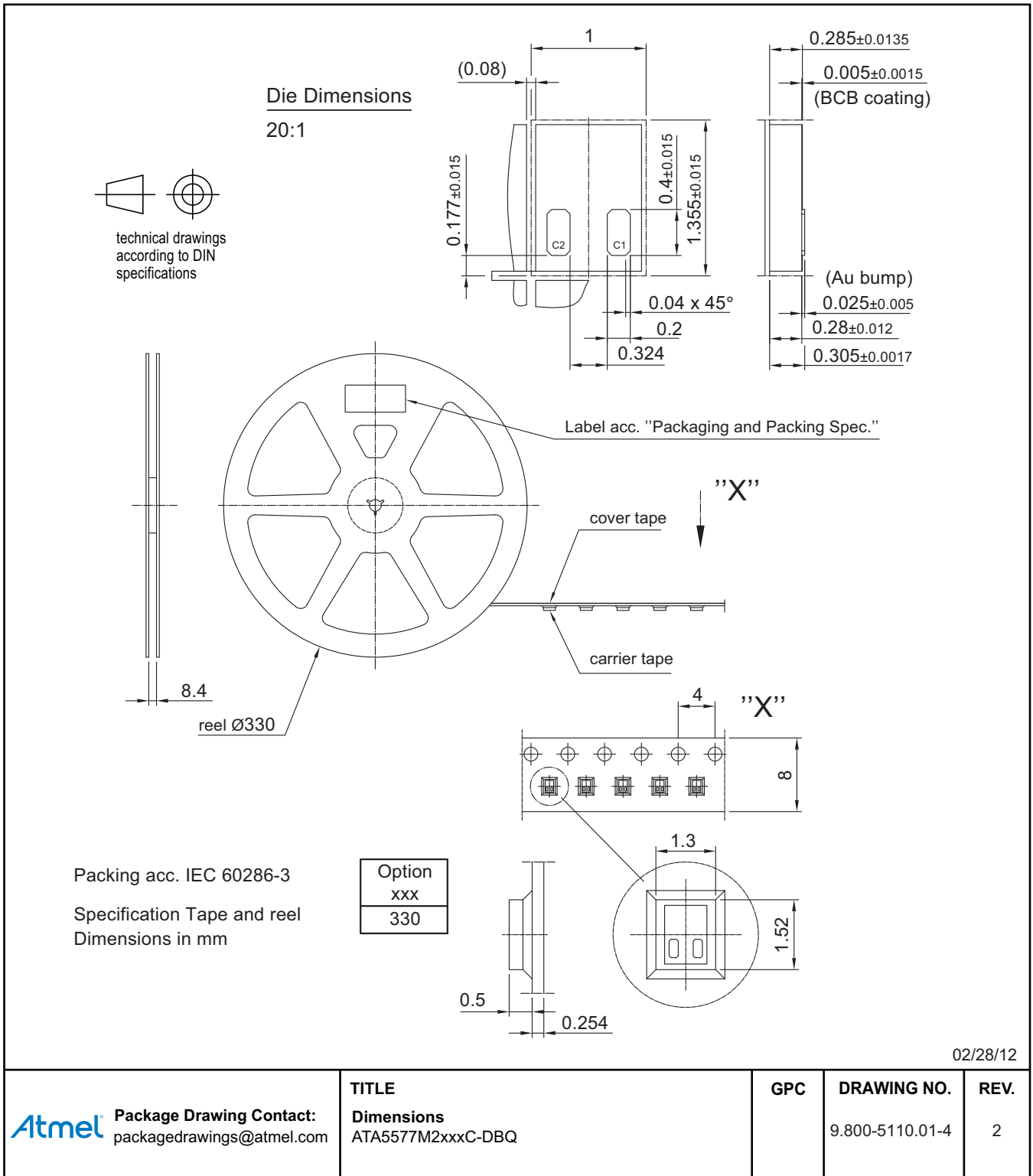

Figure 11-4. NOA3 Micromodule

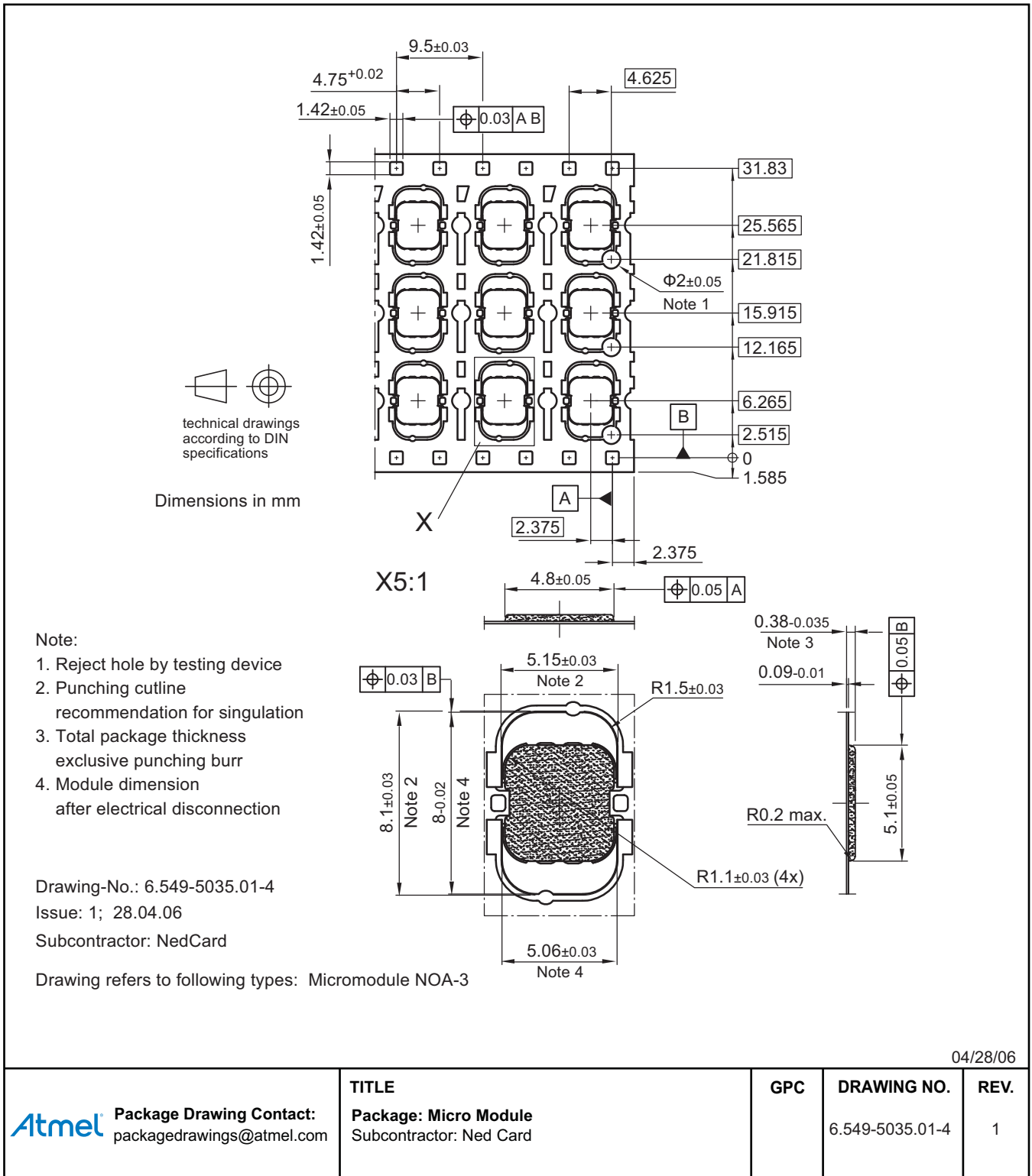

Figure 11-5. Shipping Reel for NOA3 Micromodule

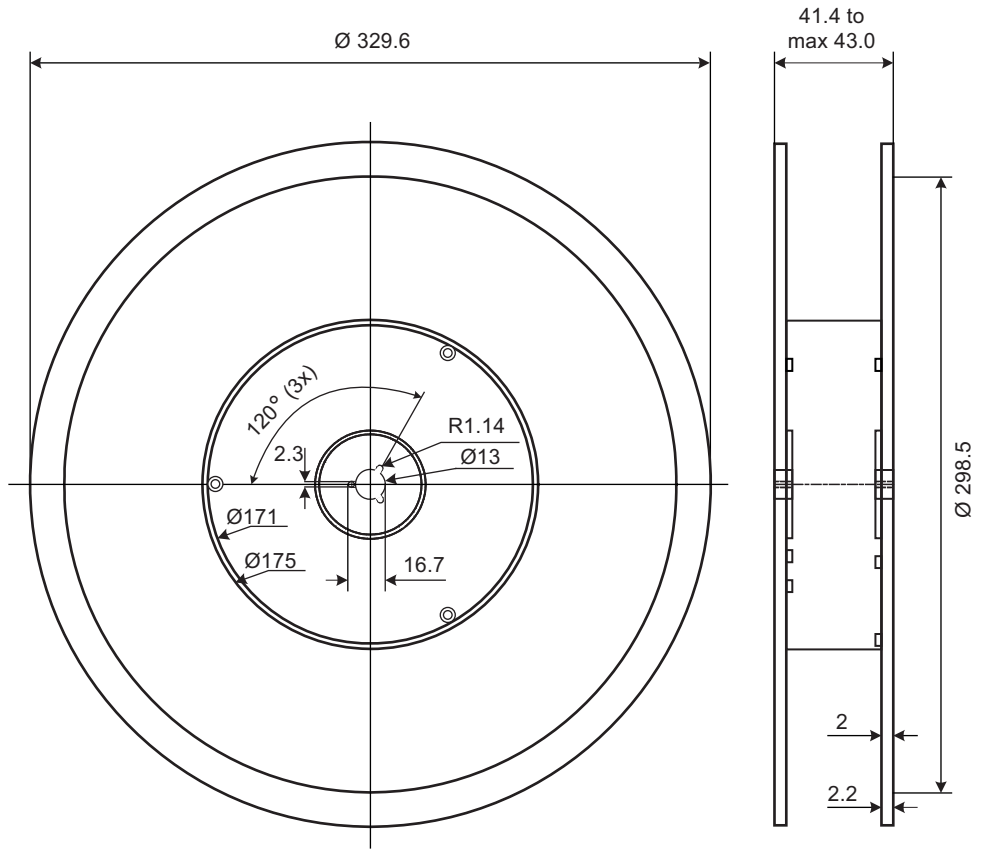
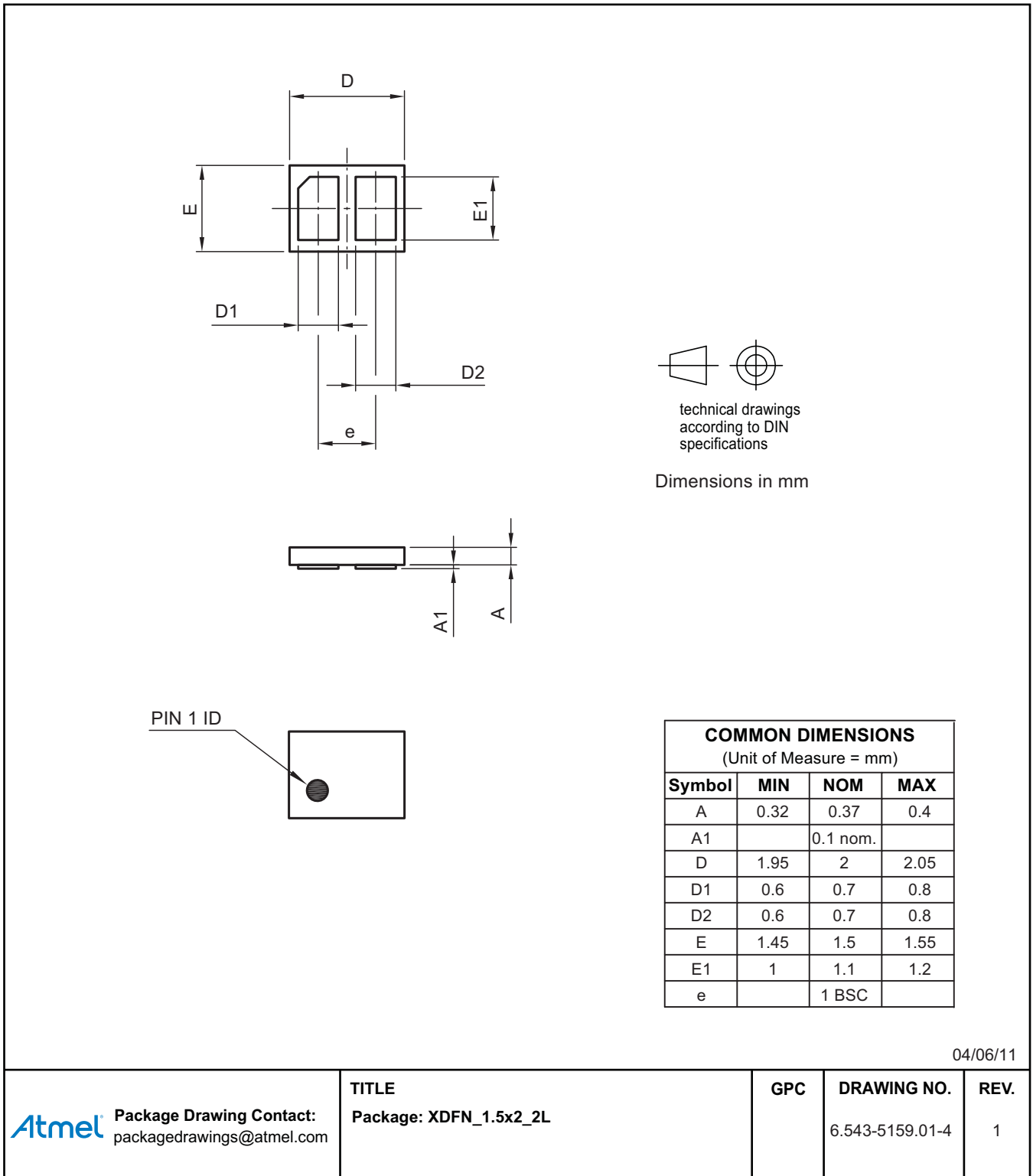

Figure 11-6. XDFN Package



12. Revision History

Please note that the following page numbers referred to in this section refer to the specific revision mentioned, not to this document.

Revision No.	History
9187H-RFID-07/14	<ul style="list-style-type: none">• Section 10 “Ordering Information” on pages 38 to 39 updated• Section 11 “Package Information” on pages 40 to 45 updated
9187G-RFID-04/13	<ul style="list-style-type: none">• Section 10 “Ordering Information” on pages 37 to 38 updated
9187F-RFID-01/13	<ul style="list-style-type: none">• Section 5.5 “Initialization and Init-Delay” on page 11 updated• Figure 5-1 “Answer-on-request (AOR) Mode ...” on page 12 updated• Figure 5-9 “Complete Writing Sequence ...” on page 19 updated• Ordering Information for ATA5577M1cccC-DDW on pages 37 and 38 added
9187E-RFID-07/12	<ul style="list-style-type: none">• Section 10 “Ordering Information” on pages 37 to 38: Ordering codes added
9187D-RFID-04/12	<ul style="list-style-type: none">• Figure 11-4 “Die in Blister Tape” on page 42 added• Figure 11-5 “Die on Sticky Tape” on page 43 updated
9187C-RFID-04/11	<ul style="list-style-type: none">• Figure 11-1 “Pad Layout (Type 1, Standard Pads)” on page 41 removed• Figure 11-2 “Pad Layout (Type 2, Mega Pads)” on page 42 removed
9187BX-RFID-03/11	<ul style="list-style-type: none">• Section 10 “Ordering Information” on page 39 changed• Section 10.1 “Available Order Codes” on page 40 changed• Figure 11-4 “Die in Waffle Pack” on page 44 added



Atmel Corporation 1600 Technology Drive, San Jose, CA 95110 USA T: (+1)(408) 441.0311 F: (+1)(408) 436.4200 | www.atmel.com

© 2014 Atmel Corporation. / Rev.: 9187H–RFID–07/14

Atmel®, Atmel logo and combinations thereof, Enabling Unlimited Possibilities®, AVR®, AVR Studio®, and others are registered trademarks or trademarks of Atmel Corporation in U.S. and other countries. Other terms and product names may be trademarks of others.

DISCLAIMER: The information in this document is provided in connection with Atmel products. No license, express or implied, by estoppel or otherwise, to any intellectual property right is granted by this document or in connection with the sale of Atmel products. EXCEPT AS SET FORTH IN THE ATMEL TERMS AND CONDITIONS OF SALES LOCATED ON THE ATMEL WEBSITE, ATMEL ASSUMES NO LIABILITY WHATSOEVER AND DISCLAIMS ANY EXPRESS, IMPLIED OR STATUTORY WARRANTY RELATING TO ITS PRODUCTS INCLUDING, BUT NOT LIMITED TO, THE IMPLIED WARRANTY OF MERCHANTABILITY, FITNESS FOR A PARTICULAR PURPOSE, OR NON-INFRINGEMENT. IN NO EVENT SHALL ATMEL BE LIABLE FOR ANY DIRECT, INDIRECT, CONSEQUENTIAL, PUNITIVE, SPECIAL OR INCIDENTAL DAMAGES (INCLUDING, WITHOUT LIMITATION, DAMAGES FOR LOSS AND PROFITS, BUSINESS INTERRUPTION, OR LOSS OF INFORMATION) ARISING OUT OF THE USE OR INABILITY TO USE THIS DOCUMENT, EVEN IF ATMEL HAS BEEN ADVISED OF THE POSSIBILITY OF SUCH DAMAGES. Atmel makes no representations or warranties with respect to the accuracy or completeness of the contents of this document and reserves the right to make changes to specifications and products descriptions at any time without notice. Atmel does not make any commitment to update the information contained herein. Unless specifically provided otherwise, Atmel products are not suitable for, and shall not be used in, automotive applications. Atmel products are not intended, authorized, or warranted for use as components in applications intended to support or sustain life.

SAFETY-CRITICAL, MILITARY, AND AUTOMOTIVE APPLICATIONS DISCLAIMER: Atmel products are not designed for and will not be used in connection with any applications where the failure of such products would reasonably be expected to result in significant personal injury or death ("Safety-Critical Applications") without an Atmel officer's specific written consent. Safety-Critical Applications include, without limitation, life support devices and systems, equipment or systems for the operation of nuclear facilities and weapons systems. Atmel products are not designed nor intended for use in military or aerospace applications or environments unless specifically designated by Atmel as military-grade. Atmel products are not designed nor intended for use in automotive applications unless specifically designated by Atmel as automotive-grade.