

Features

- Abot assembly
- Distance sensor and servomotor data

Description

The guide for assembling the Abot robot chassis
Including the basic data

Table of Contents

| | |
|---|----|
| 1. Introduction | 3 |
| 2. Basic data | 3 |
| 2.1 HSR-1425CR Continuous Rotation Servo | 3 |
| 2.2 Pololu Carrier with Sharp GP2Y0D810Z0F Digital Distance Sensor 10cm | 4 |
| 3. Assembling Abot | 5 |
| 3.1 Assemble the wheels | 5 |
| 3.2 Assemble the motors | 6 |
| 3.3 Assemble the ball caster | 8 |
| 3.4 Assemble the Distance Sensor | 9 |
| 3.5 Assemble battery | 10 |
| 3.6 Assemble control unit | 11 |
| 3.7 Add your own stuff | 12 |

1. Introduction

This document provides a step by step assembly guide for Abot
You can also find the Servo and Distance sensor basic data.

2. Basic data

2.1 HSR-1425CR Continuous Rotation Servo

| HSR-1425CR Continuous Rotation Servo | |
|--------------------------------------|--------|
| Motor Ctrl (PWM) | Yellow |
| Motor pwr (4.8-6.0V) | Red |
| Motor GND | Black |



| | |
|-------------------|---|
| Control System | Pulse Width Modulation 20 000uSec Frame |
| Neutral position | 1 500uSec +/-50uSec |
| Direction | Clock wise pulse traveling 1500 to 1900uSec |
| Operating Voltage | 4.8 to 6.0V |
| Idle current | 7.7mA |
| Running current | 150mA no load |

2.2 Pololu Carrier with Sharp GP2Y0D810Z0F Digital Distance Sensor 10cm

| Digital Distance Sensor | |
|--------------------------------------|-----|
| Square pad | GND |
| operating voltage: 2.7 V to 6.2 V | VIN |
| digital out | OUT |

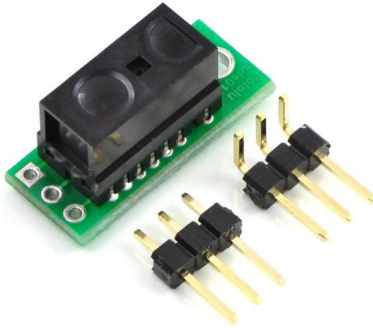

The square pad is ground, the middle pad is VIN (2.7 – 6.2 V), and the remaining pad is the sensor output, OUT. The output, Vo, is driven low when the sensor detects an object; otherwise, the output is high.

The Pololu carrier board lets you interface with the GP2Y0D805 or GP2Y0D810 sensor using a three-pin 0.1" connector, such as the included 3×1 straight male header strip and 3×1 right-angle male header strip.

Feature summary

- operating voltage: 2.7 V to 6.2 V
- average current consumption: 5 mA (typical)
- distance measuring range for GP2Y0D810Z0F: 2 cm to 10 cm (0.8" to 4")
- output type: digital voltage
- steady state response time: 2.56 ms typical (3.77 ms max)

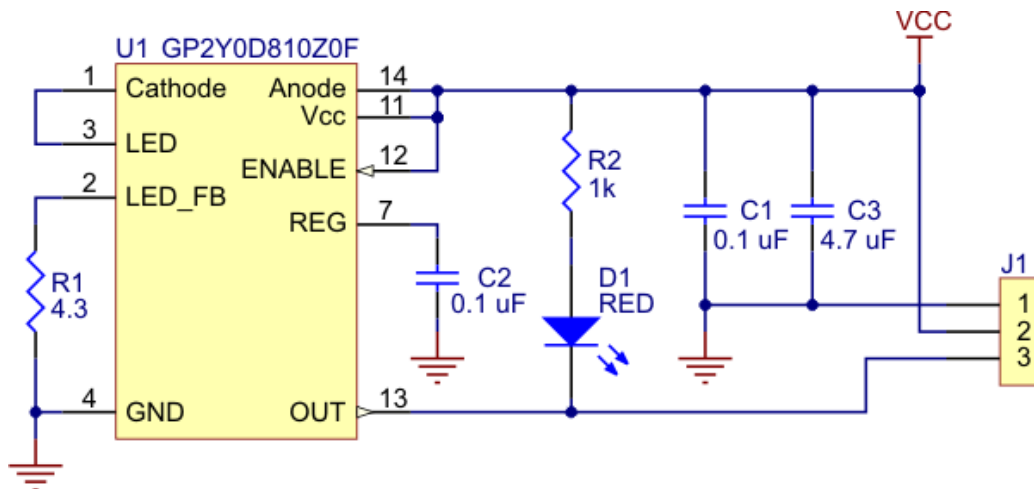

3. Assembling Abot

Tools required

- Screwdriver
- Drill with 2mm bit

3.1 Assemble the wheels

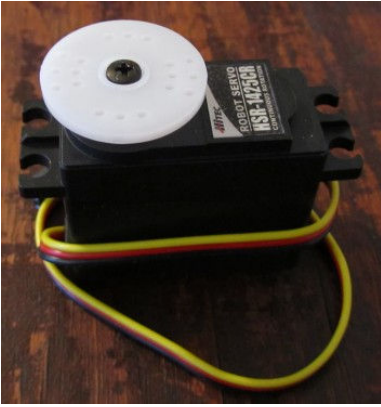

Unpack the motor



Remove the center screw



Use a 2mm drill on the 4 holes for wheel to horn assembly.

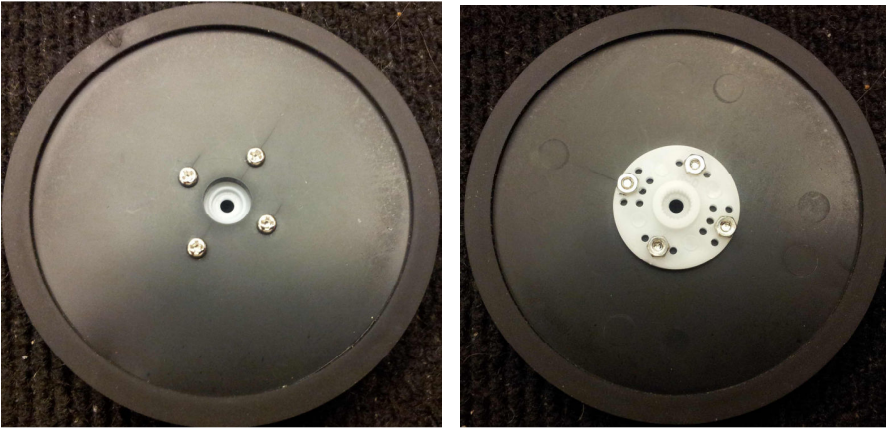

Attach the horn to the wheel using 4x 2mm screws w/nut

3.2 Assemble the motors

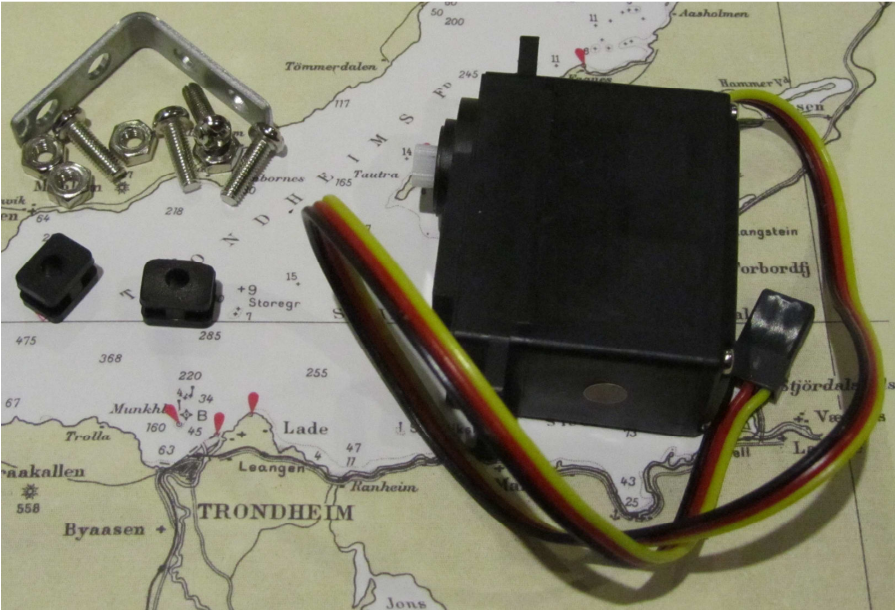

parts

To assemble one bracket you need these

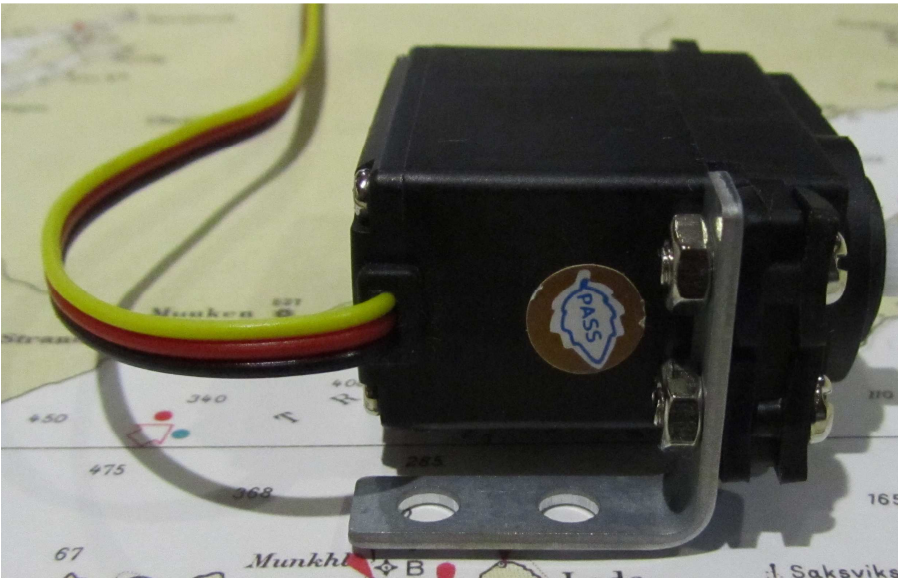

Assemble bracket to motor

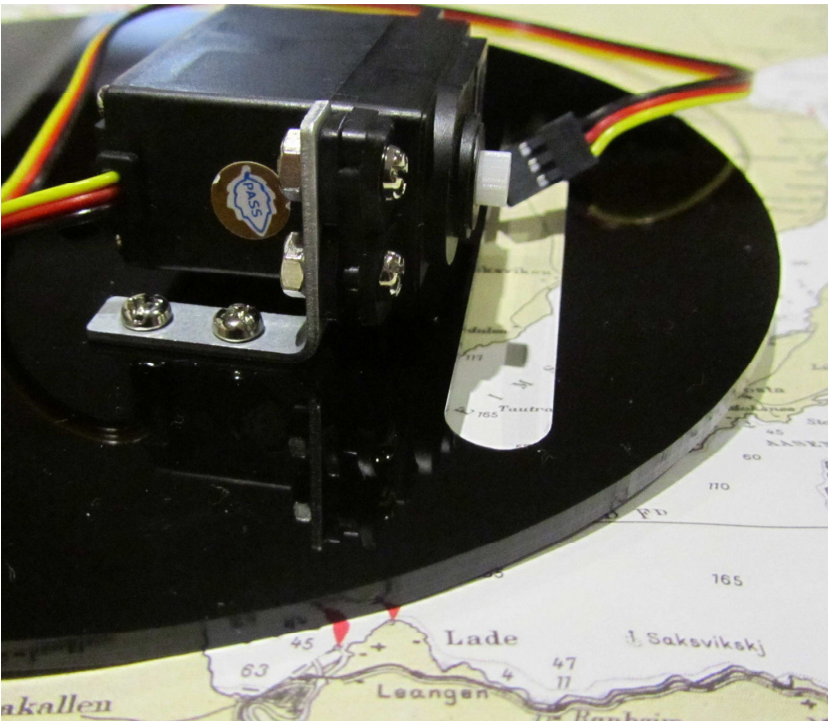

Assemble motor to chassis

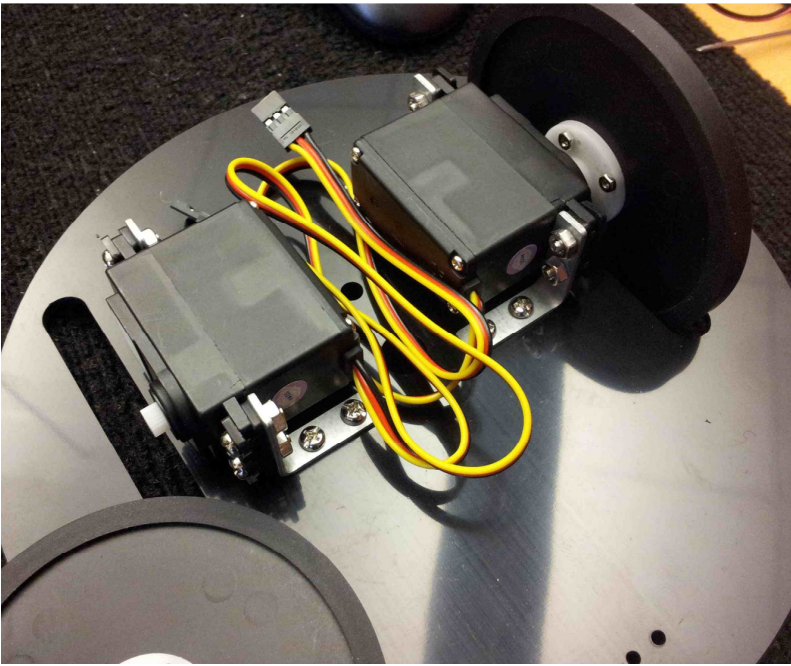

Adjust to align wheels before fasten

3.3 Assemble the ball caster



Open the package and remove the ball.



Attach the ball caster to the base plate with the two shortest screw's (on the opposite side as the motors)

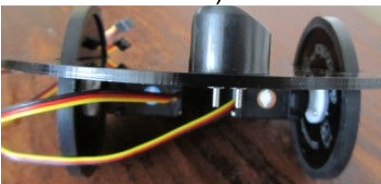



Insert the white cylinders and insert the ball

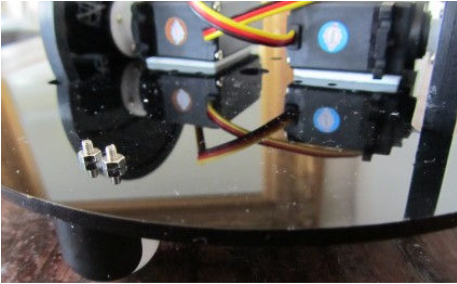

3.4 Assemble the Distance Sensor

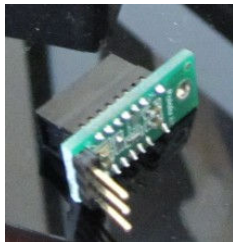

Unpack the sensor and solder the connector

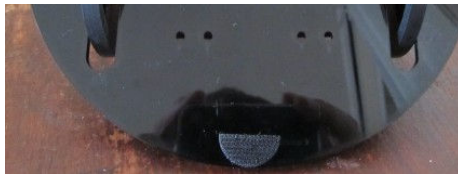
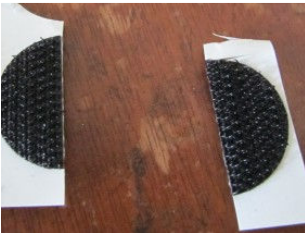

Cutt the Velcron in a sutable size and glue to front

bottom of base plate



Glue the other Velcron part to the sensor



Attach wires and fasten the sensor to the base plate

3.5 Assemble battery



Unpack battery case



Glue Velcron to battery case



Attach other part of Velcron to battery case and remove protection



Glue the Velcron to the base plate by the ball caster.

3.6 Assemble control unit

A number of development boards from Atmel can be used as control unit.

Bellow an example with the Raven kit (ATAVRRZRAVEN) and the MEGA-1284P Xplained (ATMEGA1284P-XPLD)



The wires can be “hidden” between the motors

The Raven or XPLD kit can be fastened to the top of the motors with Velcron

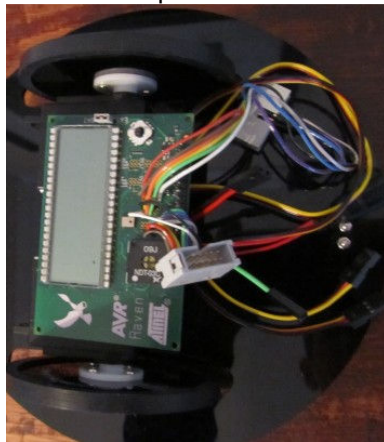

Or behind the motor:

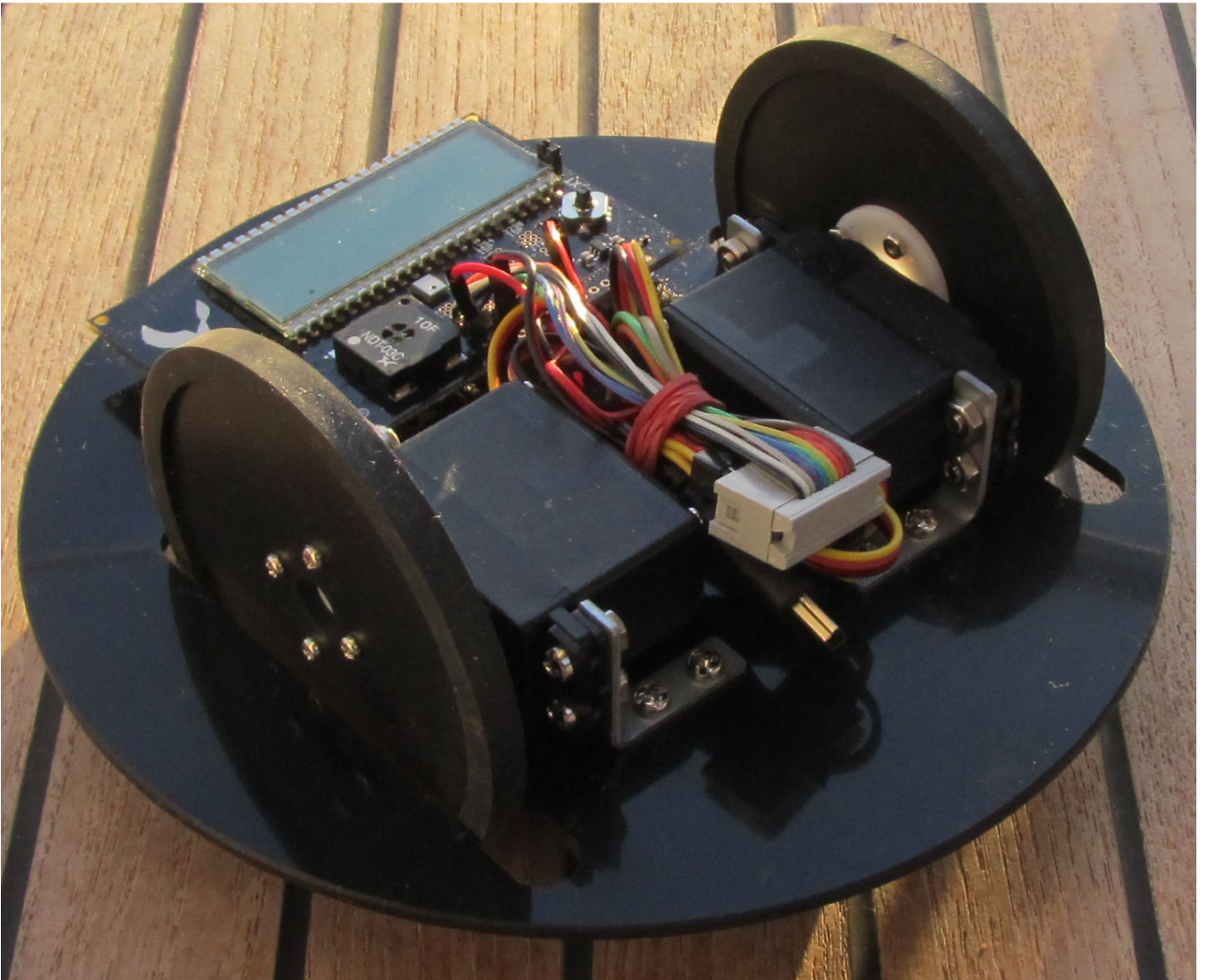

3.7 Add yor own stuff

It is easy to glue or screw new sensors etc. to the chassis.



Atmel Corporation

2325 Orchard Parkway
San Jose, CA 95131
USA

Tel: (+1)(408) 441-0311

Fax: (+1)(408) 487-2600

www.atmel.com

Atmel Asia Limited

Unit 01-5 & 16, 19F
BEA Tower, Millennium City 5
418 Kwun Tong Road
Kwun Tong, Kowloon

HONG KONG

Tel: (+852) 2245-6100

Fax: (+852) 2722-1369

Atmel Munich GmbH

Business Campus
Parking 4
D-85748 Garching b. Munich
GERMANY

Tel: (+49) 89-31970-0

Fax: (+49) 89-3194621

Atmel Japan G.K.

16F Shin-Osaki Kangyo Building
1-6-4 Osaki
Shinagawa-ku, Tokyo 141-0032
JAPAN

Tel: (+81)(3) 6417-0300

Fax: (+81)(3) 6417-0370

© 2012 Atmel Corporation. All rights reserved. / Rev.: **Datasheet-TEMPLATE-01/12**

Atmel®, Atmel logo and combinations thereof, Enabling Unlimited Possibilities®, and others are registered trademarks or trademarks of Atmel Corporation or its subsidiaries. Other terms and product names may be trademarks of others.

Disclaimer: The information in this document is provided in connection with Atmel products. No license, express or implied, by estoppel or otherwise, to any intellectual property right is granted by this document or in connection with the sale of Atmel products. EXCEPT AS SET FORTH IN THE ATMEL TERMS AND CONDITIONS OF SALES LOCATED ON THE ATMEL WEBSITE, ATMEL ASSUMES NO LIABILITY WHATSOEVER AND DISCLAIMS ANY EXPRESS, IMPLIED OR STATUTORY WARRANTY RELATING TO ITS PRODUCTS INCLUDING, BUT NOT LIMITED TO, THE IMPLIED WARRANTY OF MERCHANTABILITY, FITNESS FOR A PARTICULAR PURPOSE, OR NON-INFRINGEMENT. IN NO EVENT SHALL ATMEL BE LIABLE FOR ANY DIRECT, INDIRECT, CONSEQUENTIAL, PUNITIVE, SPECIAL OR INCIDENTAL DAMAGES (INCLUDING, WITHOUT LIMITATION, DAMAGES FOR LOSS AND PROFITS, BUSINESS INTERRUPTION, OR LOSS OF INFORMATION) ARISING OUT OF THE USE OR INABILITY TO USE THIS DOCUMENT, EVEN IF ATMEL HAS BEEN ADVISED OF THE POSSIBILITY OF SUCH DAMAGES. Atmel makes no representations or warranties with respect to the accuracy or completeness of the contents of this document and reserves the right to make changes to specifications and products descriptions at any time without notice. Atmel does not make any commitment to update the information contained herein. Unless specifically provided otherwise, Atmel products are not suitable for, and shall not be used in, automotive applications. Atmel products are not intended, authorized, or warranted for use as components in applications intended to support or sustain life.