

AMMC-5620

6 - 20 GHz High Gain Amplifier

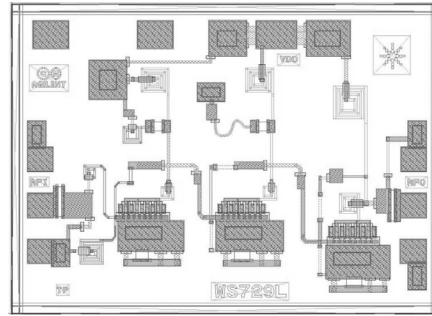

Data Sheet



Chip Size: 1410 x 1010 μm (55.5 x 39.7 mils)

Chip Size Tolerance: $\pm 10 \mu\text{m}$ (± 0.4 mils)

Chip Thickness: $100 \pm 10 \mu\text{m}$ (4 ± 0.4 mils)

Pad Dimensions: $80 \times 80 \mu\text{m}$ (3.1 x 3.1 mils or larger)

Description

Avago Technologies' AMMC-5620 MMIC is a GaAs wide-band amplifier designed for medium output power and high gain over the 6 - 20 GHz frequency range. The 3 cascaded stages provide high gain while the single bias supply offers ease of use. It is fabricated using a PHEMT integrated circuit process. The RF input and output ports have matching circuitry for use in 50- Ω environments. The backside of the chip is both RF and DC ground. This helps simplify the assembly process and reduces assembly related performance variations and costs. For improved reliability and moisture protection, the die is passivated at the active areas. The MMIC is a cost effective alternative to hybrid (discrete FET) amplifiers that require complex tuning and assembly processes.

Features

- Frequency Range: 6 - 20 GHz
- High Gain: 19 dB Typical
- Output Power: 15dBm Typical
- Input and Output Return Loss: < -10 dB
- Positive Gain Slope: $+0.21$ dB/GHz Typical
- Single Supply Bias: 5 V @ 95 mA Typical

Applications

- General purpose, wide-band amplifier in communication systems or microwave instrumentation
- High gain amplifier

AMMC-5620 Absolute Maximum Ratings^[1]

Symbol	Parameters/Conditions	Units	Min.	Max.
V _{DD}	Drain Supply Voltage	V		7.5
I _{DD}	Total Drain Current	mA		135
P _{DC}	DC Power Dissipation	W		1.0
P _{in}	RF CW Input Power	dBm		20
T _{ch}	Channel Temp.	$^{\circ}\text{C}$		+150
T _b	Operating Backside Temp.	$^{\circ}\text{C}$	- 55	
T _{stg}	Storage Temp.	$^{\circ}\text{C}$	- 65	+165
T _{max}	Maximum Assembly Temp. (60 sec max)	$^{\circ}\text{C}$		+300

Note:

1. Operation in excess of any one of these conditions may result in permanent damage to this device.



Note: These devices are ESD sensitive. The following precautions are strongly recommended. Ensure that an ESD approved carrier is used when dice are transported from one destination to another. Personal grounding is to be worn at all times when handling these devices

AMMC-5620 DC Specifications/Physical Properties [1]

Symbol	Parameters and Test Conditions	Units	Min.	Typical	Max.
V_{DD}	Recommended Drain Supply Current	V		5	
I_{DD}	Total Drain Supply Current ($V_{DD} = 5V$)	mA	70	95	130
I_{DD}	Total Drain Supply Current ($V_{DD} = 7V$)	mA		105	
θ_{ch-b}	Thermal Resistance [3] (Backside temperature (T_b) = 25 °C)	°C/W		33	

Notes:

1. Backside temperature $T_b = 25^\circ\text{C}$ unless otherwise noted
2. Channel-to-backside Thermal Resistance (θ_{ch-b}) = 47°C/W at $T_{channel}$ (T_c) = 150°C as measured using infrared microscopy. Thermal Resistance at backside temperature (T_b) = 25°C calculated from measured data.

AMMC-5620 RF Specifications [3]

$T_b = 25^\circ\text{C}$, $V_{DD} = 5V$, $I_{DD} = 95\text{ mA}$, $Z_o = 50\ \Omega$

Symbol	Parameters and Test Conditions	Units	Min.	Typical	Max.
$ S_{21} ^2$	Small-signal Gain	dB	16	19	22
Gain Slope	Positive Small-signal Gain Slope	dB/GHz		+0.21	
RL_{in}	Input Return Loss	dB	10	13	
RL_{out}	Output Return Loss	dB	10	14	
$ S_{12} ^2$	Reverse Isolation	dB		- 55	
P_{-1dB}	Output Power at 1 dB Gain Compression @ 20 GHz	dBm	12.5	15	
P_{sat}	Saturated Output Power (3dB Gain Compression) @ 20 GHz	dBm	14.5	17	
OIP3	Output 3rd Order Intercept Point @ 20 GHz	dBm		23.5	
NF	Noise Figure @ 20 GHz	dB		4.2	5.0

Notes:

3. 100% on-wafer RF test is done at frequency = 6, 13 and 20 GHz, except as noted.

AMMC-5620 Typical Performances ($T_{chuck}=25^{\circ}\text{C}$, $V_{DD}=5\text{V}$, $I_{DD}=95\text{ mA}$, $Z_0=50\Omega$)

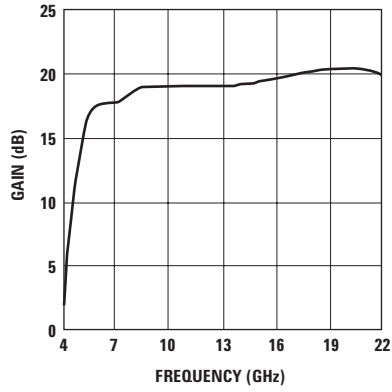

Figure 1. Gain

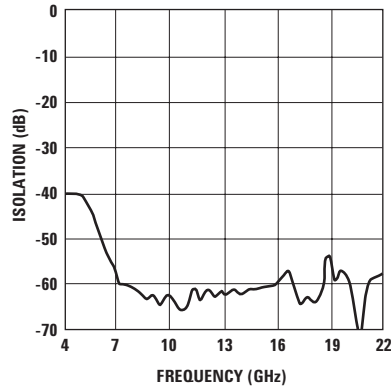

Figure 2. Isolation

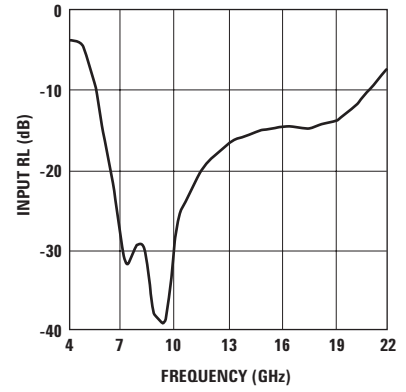

Figure 3. Input Return Loss

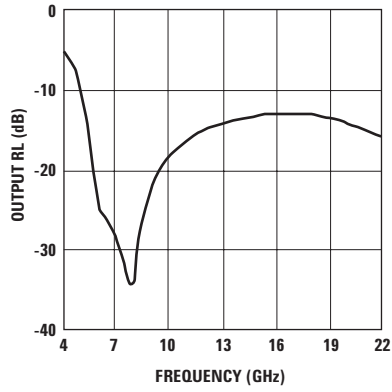

Figure 4. Output Return Loss

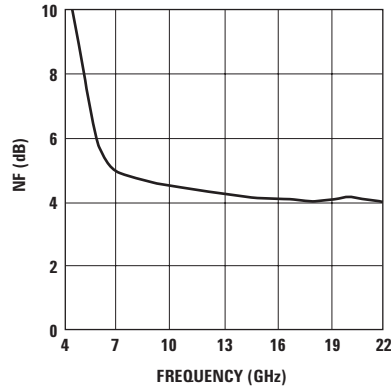

Figure 5. Noise Figure

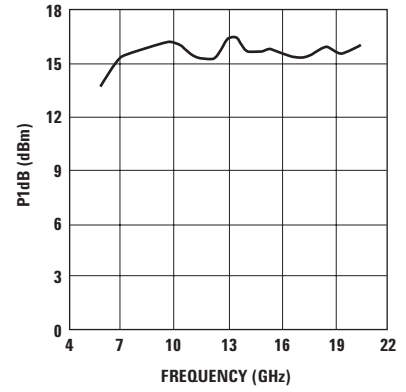

Figure 6. Output Power at 1dB Gain Compression

AMMC-5620 Typical Performances vs. Supply Voltage ($T_b = 25^{\circ}\text{C}$, $Z_0=50\Omega$)

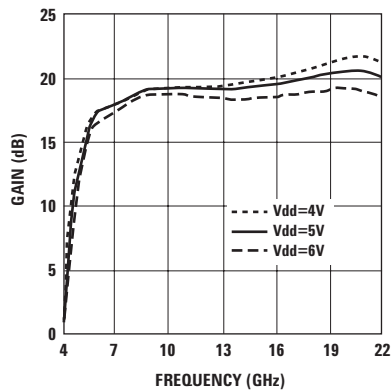

Figure 7. Gain and Voltage

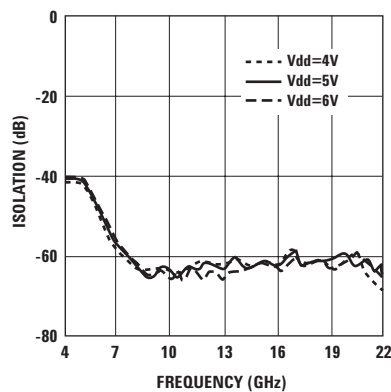

Figure 8. Isolation and Voltage

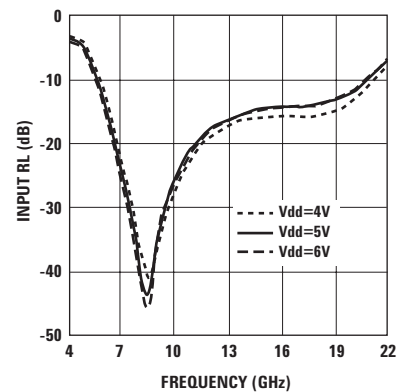

Figure 9. Input Return Loss and Voltage

AMMC-5620 Typical Performances vs. Supply Voltage (cont.) ($T_b = 25^\circ\text{C}$, $Z_o=50\Omega$)

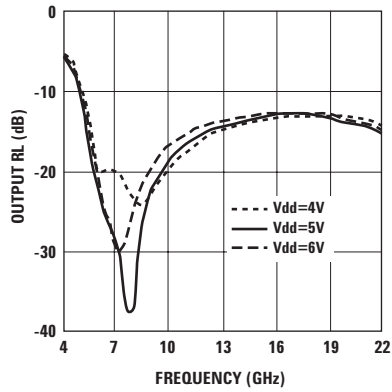

Figure 10. Output Return Loss and Voltage

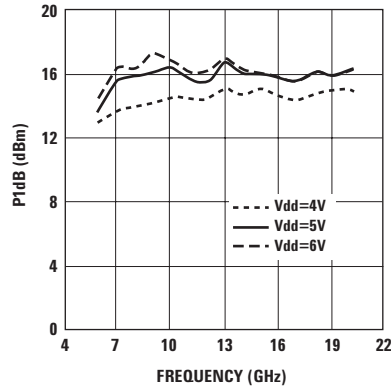

Figure 11. Output Power and Voltage

AMMC-5620 Typical Performance vs. Temperature ($V_{DD} = 5\text{V}$, $Z_o=50\Omega$)

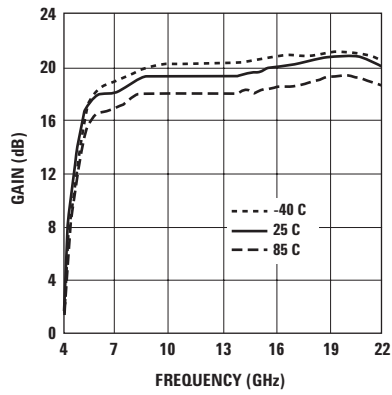

Figure 12. Gain and Temperature

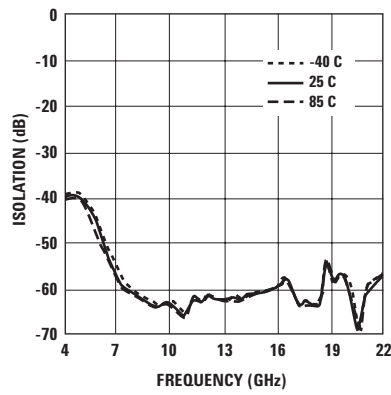

Figure 13. Isolation and Temperature

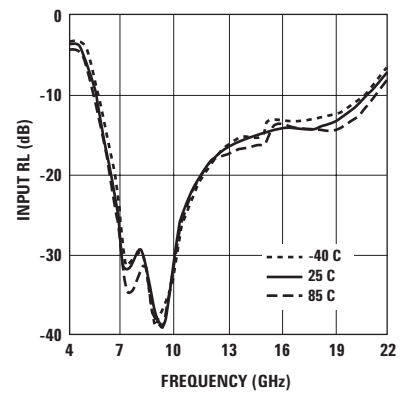

Figure 14. Input Return Loss and Temperature

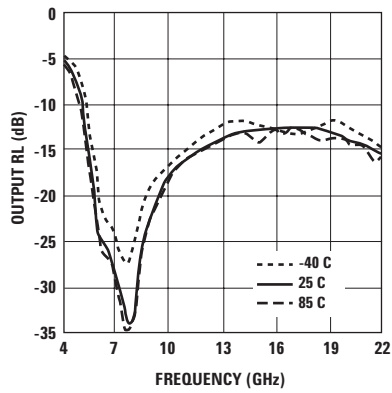

Figure 15. Output Return Loss and Temperature

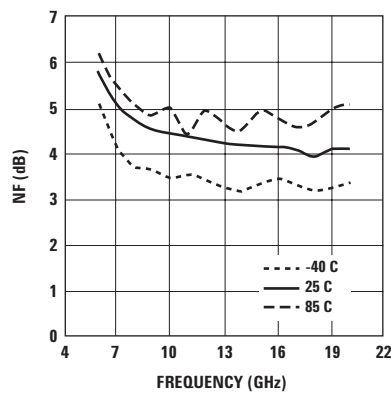

Figure 16. Noise Figure and Temperature

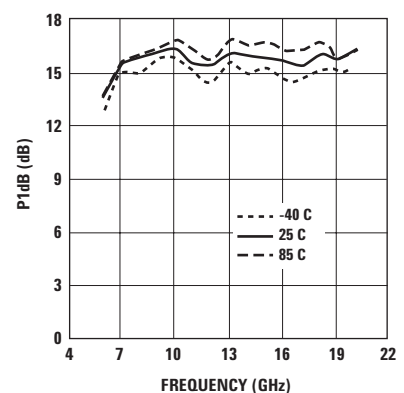

Figure 17. Output Power and Temperature

AMMC-5620 Typical Scattering Parameters ^[1] ($T_b = 25^\circ\text{C}$, $V_{DD} = 5\text{ V}$, $I_{DD} = 107\text{ mA}$)

Freq GHz	S11			S21			S12			S22		
	dB	Mag	Phase	dB	Mag	Phase	dB	Mag	Phase	dB	Mag	Phase
2.00	-2.9	0.72	-147	-23.3	0.07	-176	-50.0	0	46	-1.5	0.85	-72
2.50	-3.3	0.69	-168	-16.1	0.16	146	-46.1	0	-1	-2.5	0.75	-89
3.00	-3.5	0.67	173	-10.0	0.31	114	-44.0	0.01	-46	-3.6	0.66	-104
3.50	-3.7	0.65	154	-4.6	0.59	87	-42.9	0.01	-89	-4.5	0.6	-118
4.00	-3.8	0.64	134	0.8	1.1	62	-42.1	0.01	-132	-5.3	0.54	-136
4.50	-4.0	0.63	111	6.6	2.15	34	-41.5	0.01	-179	-6.7	0.46	-158
5.00	-5.0	0.56	81	12.0	3.96	-5	-42.1	0.01	128	-9.6	0.33	175
5.50	-7.7	0.41	49	15.2	5.73	-50	-44.7	0.01	72	-15.2	0.17	157
6.00	-12.0	0.25	23	16.7	6.84	-91	-49.0	0	19	-21.8	0.08	165
6.50	-16.9	0.14	5	17.0	7.06	-123	-53.7	0	-30	-24.8	0.06	-173
7.00	-21.9	0.08	-8	17.2	7.28	-150	-58.0	0	-78	-26.4	0.05	-164
7.50	-27.2	0.04	-18	17.4	7.41	-173	-60.6	0	-123	-30.0	0.03	-155
8.00	-32.8	0.02	-17	17.9	7.81	164	-61.9	0	-160	-34.5	0.02	-102
8.50	-33.4	0.02	-5	18.2	8.12	142	-64.4	0	-178	-28.3	0.04	-61
9.00	-30.9	0.03	-15	18.4	8.29	121	-64.4	0	-179	-23.8	0.06	-60
9.50	-27.7	0.04	-32	18.4	8.34	101	-63.1	0	-169	-21.2	0.09	-65
10.00	-24.9	0.06	-50	18.4	8.35	83	-63.5	0	157	-19.3	0.11	-72
10.50	-22.6	0.07	-66	18.5	8.37	65	-64.4	0	144	-18.1	0.12	-78
11.00	-20.7	0.09	-80	18.5	8.36	48	-64.4	0	145	-17.1	0.14	-84
11.50	-19.3	0.11	-92	18.5	8.37	32	-64.2	0	130	-16.3	0.15	-90
12.00	-18.2	0.12	-103	18.5	8.38	16	-62.1	0	127	-15.7	0.16	-95
12.50	-17.3	0.14	-113	18.5	8.4	1	-63.3	0	126	-15.1	0.18	-101
13.00	-16.6	0.15	-123	18.5	8.43	-14	-64.4	0	125	-14.7	0.18	-105
13.50	-16.0	0.16	-131	18.6	8.48	-29	-62.1	0	118	-14.4	0.19	-110
14.00	-15.6	0.17	-140	18.6	8.53	-44	-61.9	0	107	-14.2	0.2	-115
14.50	-15.3	0.17	-148	18.7	8.6	-58	-62.1	0	107	-14.0	0.2	-120
15.00	-15.1	0.18	-156	18.8	8.71	-73	-62.9	0	98	-13.7	0.21	-126
15.50	-15.0	0.18	-164	18.9	8.81	-87	-64.1	0	82	-13.6	0.21	-131
16.00	-14.9	0.18	-172	19.1	8.97	-101	-61.2	0	94	-13.4	0.21	-136
16.50	-14.9	0.18	179	19.2	9.11	-116	-60.0	0	95	-13.3	0.22	-140
17.00	-15.0	0.18	170	19.3	9.25	-131	-61.8	0	60	-13.3	0.22	-145
17.50	-15.0	0.18	160	19.5	9.43	-145	-62.1	0	80	-13.2	0.22	-150
18.00	-14.9	0.18	149	19.7	9.62	-161	-61.9	0	70	-13.2	0.22	-154
18.50	-14.7	0.18	137	19.9	9.84	-176	-62.7	0	67	-13.3	0.22	-159
19.00	-14.3	0.19	122	20.0	10	168	-61.9	0	70	-13.4	0.21	-166
19.50	-13.8	0.2	106	20.1	10.2	151	-61.9	0	61	-13.6	0.21	-171
20.00	-13.1	0.22	89	20.2	10.3	134	-60.0	0	45	-14.0	0.2	-177
20.50	-11.9	0.25	72	20.3	10.4	117	-60.9	0	41	-14.1	0.2	179
21.00	-10.5	0.3	53	20.3	10.3	99	-64.1	0	38	-14.6	0.19	173
21.50	-9.0	0.35	36	20.2	10.2	80	-67.5	0	13	-15.1	0.18	168
22.00	-7.5	0.42	19	19.9	9.88	60	-67.5	0	5	-15.5	0.17	162

Note:

Data obtained from on-wafer measurements.

Biasing and Operation

The AMMC-5620 is normally biased with a single positive drain supply connected to the VDD bond pads shown in Figure 19. The recommended supply voltage is 5 V, which results in $I_{DD} = 95 \text{ mA}$ (typical).

No ground wires are required because all ground connections are made with plated through-holes to the backside of the device.

Refer the Absolute Maximum Ratings table for allowed DC and thermal conditions.

Assembly Techniques

The backside of the AMMC-5620 chip is RF ground. For microstripline applications, the chip should be attached directly to the ground plane (e.g., circuit carrier or heat-sink) using electrically conductive epoxy [1,2].

For best performance, the topside of the MMIC should be brought up to the same height as the circuit surrounding it. This can be accomplished by mounting a gold plated metal shim (same length and width as the MMIC) under the chip, which is of the correct thickness to make the chip and adjacent circuit coplanar.

The amount of epoxy used for chip and or shim attachment should be just enough to provide a thin fillet around the bottom perimeter of the chip or shim. The ground plane should be free of any residue that may jeopardize electrical or mechanical attachment.

The location of the RF bond pads is shown in Figure 20. Note that all the RF input and output ports are in a Ground-Signal-Ground configuration.

RF connections should be kept as short as reasonable to minimize performance degradation due to undesirable series inductance. A single bond wire is sufficient for signal connections, however double-bonding with 0.7 mil gold wire or the use of gold mesh is recommended for best performance, especially near the high end of the frequency range.

Thermosonic wedge bonding is the preferred method for wire attachment to the bond pads. Gold mesh can be attached using a 2 mil round tracking tool and a tool force of approximately 22 grams with an ultrasonic power of roughly 55 dB for a duration of $76 \pm 8 \text{ mS}$. A guided wedge at an ultrasonic power level of 64 dB can be used for the 0.7 mil wire. The recommended wire bond stage temperature is $150 \pm 2 \text{ }^\circ \text{C}$.

Caution should be taken to not exceed the Absolute Maximum Rating for assembly temperature and time.

The chip is 100 μm thick and should be handled with care. This MMIC has exposed air bridges on the top surface and should be handled by the edges or with a custom collet (do not pick up die with vacuum on die center.)

This MMIC is also static sensitive and ESD handling precautions should be taken.

Notes:

1. Ablebond 84-1 LM1 silver epoxy is recommended.
2. Eutectic attach is not recommended and may jeopardize reliability of the device.

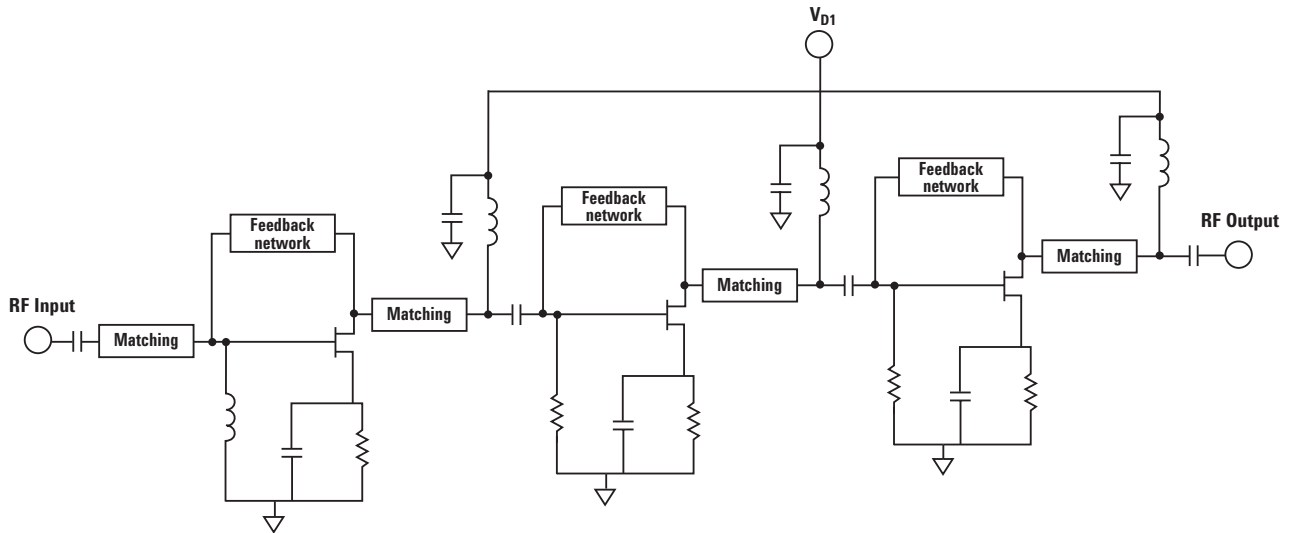

Figure 18. AMMC-5620 Schematic

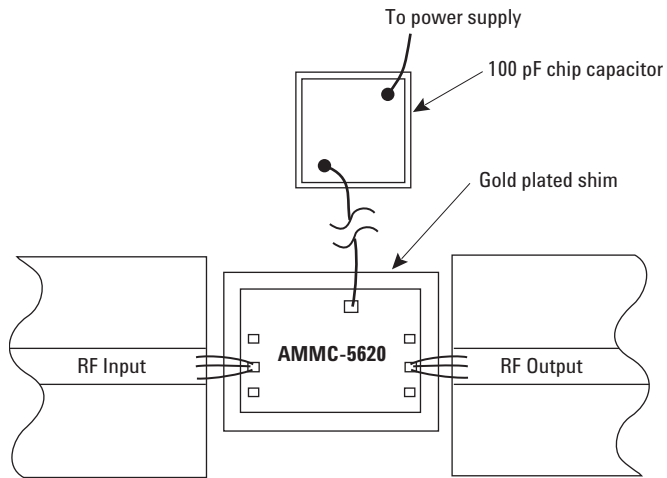

Figure 19. AMMC-5620 Assembly Diagram

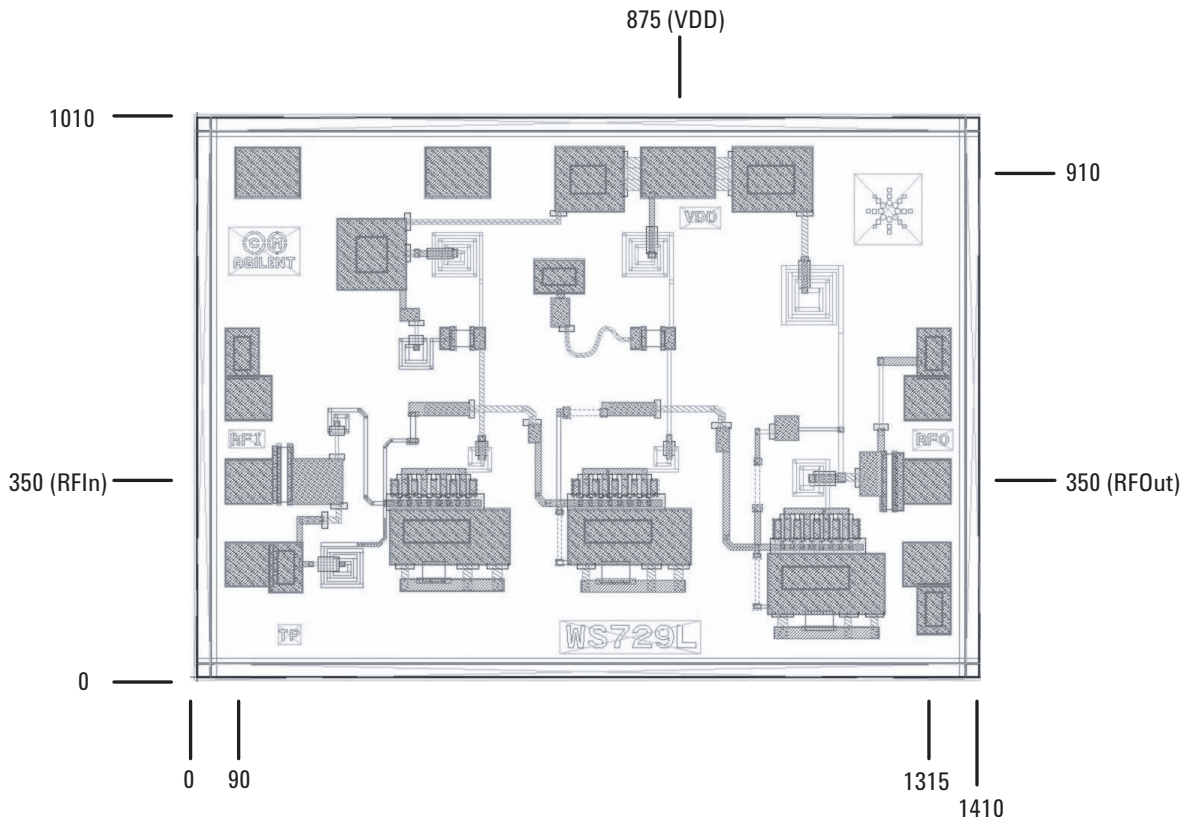

Figure 20. AMMC-5620 Bond Pad Locations.
(dimensions in microns)

Ordering Information:

AMMC-5620-W10 = 10 devices per tray

AMMC-5620-W50 = 50 devices per tray

For product information and a complete list of distributors, please go to our web site: www.avagotech.com

Avago, Avago Technologies, and the A logo are trademarks of Avago Technologies Limited in the United States and other countries. Data subject to change. Copyright © 2005-2008 Avago Technologies Limited. All rights reserved. Obsoletes AV01-0222EN AV02-0528EN - May 21, 2008

