

HEDM-55xx/560x & HEDS-55xx/56xx

Quick Assembly Two and Three Channel Optical Encoders



Data Sheet



Description

The HEDS-5500/5540, HEDS-5600/5640, HEDM-5500/5540 and HEDM-5600 are high performance, low cost, two and three channel optical incremental encoders. These encoders emphasize high reliability, high resolution, and easy assembly.

Each encoder contains a lensed LED source, an integrated circuit with detectors and output circuitry, and a codewheel which rotates between the emitter and detector IC. The outputs of the HEDS-5500/5600 and HEDM-5500/5600 are two square waves in quadrature. The HEDS-5540/5640 and HEDM-5540 also have a third channel index output in addition to the two channel quadrature. This index output is a 90 electrical degree, high true index pulse which is generated once for each full rotation of the codewheel.

The HEDS series utilizes metal codewheels, while the HEDM series utilizes a film codewheel allowing for resolutions to 1024 CPR.

These encoders may be quickly and easily mounted to a motor. For larger diameter motors, the HEDM-5600, and HEDS-5600/5640 feature external mounting ears.

The quadrature signals and the index pulse are accessed through five 0.025 inch square pins located on 0.1 inch centers.

Standard resolutions between 96 and 1024 counts per revolution are presently available. Consult local Avago sales representatives for other resolutions.

Features

- Two channel quadrature output with optional index pulse
- Quick and easy assembly
- No signal adjustment required
- External mounting ears available
- Low cost
- Resolutions up to 1024 counts per revolution
- Small size –40°C to 100°C operating temperature
- TTL compatible
- Single 5 V supply

Applications

The HEDS-5500, 5540, 5600, 5640, and the HEDM-5500, 5540, 5600 provide motion detection at a low cost, making them ideal for high volume applications. Typical applications include printers, plotters, tape drives, positioning tables, and automatic handlers.

Note: Avago Technologies encoders are not recommended for use in safety critical applications. Eg. ABS braking systems, power steering, life support systems and critical care medical equipment. Please contact sales representative if more clarification is needed.

ESD WARNING: NORMAL HANDLING PRECAUTIONS SHOULD BE TAKEN TO AVOID STATIC DISCHARGE.

Package Dimensions

HEDS-5500/5540, HEDM-5500/5540



*Notes:

For the HEDS-5500 and HEDM-5500, Pin #2 is a No Connect.
 For the HEDS-5540 and HEDM-5540, Pin #2 is CH. I, the index output.

HEDS-5600/5640, HEDM-5600, HEDM-5640



*Notes:

For the HEDS-5600 and HEDM-5600, Pin #2 is a No Connect.
 For the HEDS-5640 and HEDM-5640, Pin #2 is CH. I, the index output.

Theory of Operation

The HEDS-5500/5540, HEDS-5600/5640, HEDM-5500/5540 and HEDM-5600 translate the rotary motion of a shaft into either a two- or a three-channel digital output.

As seen in the block diagram, these encoders contain a single Light Emitting Diode (LED) as its light source. The light is collimated into a parallel beam by means of a single polycarbonate lens located directly over the LED. Opposite the emitter is the integrated detector circuit. This IC consists of multiple sets of photodetectors and the signal processing circuitry necessary to produce the digital waveforms.

The codewheel rotates between the emitter and detector, causing the light beam to be interrupted by the pattern of spaces and bars on the codewheel. The photodiodes which detect these interruptions are arranged in a pattern that corresponds to the radius and design of the codewheel. These detectors are also spaced such that a light period on one pair of detectors corresponds to a dark period on the adjacent pair of detectors. The photodiode outputs are then fed through the signal processing circuitry resulting in A, \bar{A} , B and \bar{B} (also I and \bar{I} in the HEDS-5540/5640 and HEDM-5540). Comparators receive these signals and produce the final outputs for channels A and B. Due to this integrated phasing technique, the digital output of channel A is in quadrature with that of channel B (90 degrees out of phase).

In the HEDS-5540/5640 and HEDM-5540, the output of the comparator for I and \bar{I} is sent to the index processing circuitry along with the outputs of channels A and B.

The final output of channel I is an index pulse PO which is generated once for each full rotation of the codewheel. This output PO is a one state width (nominally 90 electrical degrees), high true index pulse which is coincident with the low states of channels A and B.

Block Diagram



Note: Circuitry for CH I is only for HEDS-5540/5640, HEDM-5540/5540 Three Channel Encoder

Definitions

Count (N): The number of bar and window pairs or counts per revolution (CPR) of the codewheel.

One Cycle (C): 360 electrical degrees ($^{\circ}$ e), 1 bar and window pair.

One Shaft Rotation: 360 mechanical degrees, N cycles.

Position Error ($\Delta\theta$): The normalized angular difference between the actual shaft position and the position indicated by the encoder cycle count.

Cycle Error (ΔC): An indication of cycle uniformity. The difference between an observed shaft angle which gives rise to one electrical cycle, and the nominal angular increment of $1/N$ of a revolution.

Pulse Width (P): The number of electrical degrees that an output is high during 1 cycle. This value is nominally 180° e or $1/2$ cycle.

Pulse Width Error (ΔP): The deviation, in electrical degrees, of the pulse width from its ideal value of 180° e.

State Width (S): The number of electrical degrees between a transition in the output of channel A and the neighbouring transition in the output of channel B. There are 4 states per cycle, each nominally 90° e.

State Width Error (ΔS): The deviation, in electrical degrees, of each state width from its ideal value of 90° e.

Phase (ϕ): The number of electrical degrees between the center of the high state of channel A and the center of the high state of channel B. This value is nominally 90° e for quadrature output.

Phase Error ($\Delta\phi$): The deviation of the phase from its ideal value of 90° e.

Direction of Rotation: When the codewheel rotates in the counter-clockwise direction (as viewed from the encoder end of the motor), channel A will lead channel B. If the codewheel rotates in the clockwise direction, channel B will lead channel A.

Index Pulse Width (P_0): The number of electrical degrees that an index output is high during one full shaft rotation. This value is nominally 90° e or $1/4$ cycle.

Absolute Maximum Ratings

Parameter	HEDS-55XX/56XX	HEDM-550X/560X	HEDM-5540/5640
Storage Temperature, T_S	-40°C to 100°C	-40°C to +70°C	-40°C to 85°C
Operating Temperature, T_A	-40°C to 100°C	-40°C to +70°C	-40°C to 85°C
Supply Voltage, V_{CC}	-0.5 V to 7 V	-0.5 V to 7 V	-0.5 V to 7 V
Output Voltage, V_O	-0.5 V to VCC	-0.5 V to VCC	-0.5 V to VCC
Output Current per Channel, I_{OUT}	-1.0 mA to 5 mA	-1.0 mA to 5 mA	-1.0 mA to 5 mA
Vibration	20 g, 5 to 1000 Hz	20 g, 5 to 1000 Hz	20 g, 5 to 1000 Hz
Shaft Axial Play	± 0.25 mm (± 0.010 in.)	± 0.175 mm (± 0.007 in.)	± 0.175 mm (± 0.007 in.)
Shaft Eccentricity Plus Radial Play	0.1 mm (0.004 in.) TIR	0.04 mm (0.0015 in.) TIR	0.04 mm (0.0015 in.) TIR
Velocity	30,000 RPM	30,000 RPM	30,000 RPM
Acceleration	250,000 rad/sec ²	250,000 rad/sec ²	250,000 rad/sec ²

Output Waveforms



Recommended Operating Conditions

Parameter	Sym.	Min.	Typ.	Max.	Units	Notes
Temperature HEDS Series	T _A	-40		100	°C	
Temperature HEDM Series	5500/5600	T _A	-40	70	°C	non-condensing atmosphere
	5540/5640	T _A	-40	85	°C	
Supply Voltage	V _{CC}	4.5	5.0	5.5	Volts	Ripple < 100 mVp-p
Load Capacitance	C _L			100	pF	2.7 kΩ pull-up
Count Frequency	f			100	kHz	Velocity (rpm) x N/60
Shaft Perpendicularity Plus Axial Play (HEDS Series)				± 0.25 (±0.010)	mm (in.)	6.9 mm (0.27 in.) from mounting surface
Shaft Eccentricity Plus Radial Play (HEDS Series)				0.04 (0.0015)	mm (in.) TIR	6.9 mm (0.27 in.) from mounting surface
Shaft Perpendicularity Plus Axial Play (HEDM Series)				± 0.175 (±0.007)	mm (in.)	6.9 mm (0.27 in.) from mounting surface
Shaft Eccentricity Plus Radial Play (HEDM Series)				0.04 (0.0015)	mm (in.) TIR	6.9 mm (0.27 in.) from mounting surface

Note: The module performance is guaranteed to 100 kHz but can operate at higher frequencies. 2.7 kΩ pull-up resistors required for HEDS-5540/5640 and HEDM-5540/5640.

Encoding Characteristics

Part No.	Description	Sym.	Min	Typ.*	Max.	Units	
HEDS-5500	Pulse Width Error	ΔP		7	45	°e	
HEDS-5600 (Two Channel)	Logic State Width Error	ΔS		5	45	°e	
	Phase Error	ΔΦ		2	20	°e	
	Position Error	ΔΘ		10	40	min. of arc	
	Cycle Error	ΔC		3	5.5	°e	
HEDM-5500	Pulse Width Error	ΔP		10	45	°e	
HEDM-5600 (Two Channel)	Logic State Width Error	ΔS		10	45	°e	
	Phase Error	ΔΦ		2	15	°e	
	Position Error	ΔΘ		10	40	min. of arc	
	Cycle Error	ΔC		3	7.5	°e	
HEDS-5540	Pulse Width Error	ΔP		5	45	°e	
HEDS-5640 (Three Channel)	Logic State Width Error	ΔS		5	35	°e	
	Phase Error	ΔΦ		2	15	°e	
	Position Error	ΔΘ		10	40	min. of arc	
	Cycle Error	ΔC		3	5.5	°e	
	Index Pulse Width	P _o	55	90	125	°e	
	CH.I rise after CH.A or CH. B fall	t ₁	-40°C to +100°C	-300	100	250	ns
	CH.I fall after CH.A or CH. B rise	t ₂	-40°C to +100°C	70	150	1000	ns
HEDM-5540	Pulse Width Error	ΔP		10	45	°e	
HEDM-5640 (Three Channel)	Logic State Width Error	ΔS		10	45	°e	
	Phase Error	ΔΦ		2	15	°e	
	Position Error	ΔΘ		10	40	min. of arc	
	Cycle Error	ΔC		6	12	°e	
	Index Pulse Width	P _o	50	90	130	°e	
	CH.I rise after CH.A or CH. B fall	t ₁	-40°C to +85°C	200	1000	1500	ns
	CH.I fall after CH.A or CH. B rise	t ₂	-40°C to +85°C	0	300	1500	ns

Note: See Mechanical Characteristics for mounting tolerances. *Typical values specified at V_{CC} = 5.0 V and 25°C.

Electrical Characteristics

Electrical Characteristic over Recommended Operating Range

Part No.	Parameter	Sym.	Min	Typ.*	Max.	Units	Notes
HEDS-5500	Supply Current	I _{CC}		17	40	mA	
HEDS-5600	High Level Output Voltage	V _{OH}	2.4			V	I _{OH} = -40μA max
	Low Level Output Voltage	V _{OL}			0.4	V	I _{OL} = 3.2mA
	Rise Time	t _r		200		ns	C _L = 25 pF
	Fall Time	t _f		50		ns	R _L = 11 kΩ pull-up
HEDS-5540	Supply Current	I _{CC}	30	57	85	mA	
HEDS-5640	High Level Output Voltage	V _{OH}	2.4			V	I _{OH} = -200μA max
HEDM-5500	Low Level Output Voltage	V _{OL}			0.4	V	I _{OL} = 3.86mA
HEDM-5600	Rise Time	t _r		180		ns	C _L = 25 pF
	Fall Time	t _f		40		ns	R _L = 2.7 kΩ pull-up
HEDM-5500	Supply Current	I _{CC}	30	57	85	mA	
HEDM-5600	High Level Output Voltage	V _{OH}	2.4			V	I _{OH} = -40μA max
	Low Level Output Voltage	V _{OL}			0.4	V	I _{OL} = 3.86mA
	Rise Time	t _r		180		ns	C _L = 25 pF
	Fall Time	t _f		40		ns	R _L = 3.2 kΩ pull-up
HEDM-5540	Supply Current	I _{CC}	30	57	85	mA	
HEDM-5640	High Level Output Voltage	V _{OH}	2.4			V	I _{OH} = -200μA max
	Low Level Output Voltage	V _{OL}			0.4	V	I _{OL} = 3.86mA
	Rise Time	t _r		200		ns	C _L = 25 pF
	Fall Time	t _f		80		ns	R _L = 2.7 kΩ pull-up

* Typical values specified at V_{CC} = 5.0V and 25°C

Mechanical Characteristics

Parameter	Symbol	Dimension	Tolerance ^[1]	Units
Codewheel Fits These Standard Shaft Diameters		2 3 4	+0.000	mm
		5 6 8	-0.015	
		5/32 1/8	+0.0000	in
		3/16 1/4	-0.0007	
Moment of Inertia	J	0.6 (8.0 x 10 ⁻⁶)		g-cm ² (oz-in-s ²)
Required Shaft Length ^[2]		14.0 (0.55)	± 0.5 (± 0.02)	mm (in.)
Bolt Circle ^[3]	2 screw mounting	19.05 (0.750)	± 0.13 (± 0.005)	mm (in.)
	3 screw mounting	20.90 (0.823)	± 0.13 (± 0.005)	mm (in.)
	external mounting ears	46.0 (1.811)	± 0.13 (± 0.005)	mm (in.)
Mounting Screw Size ^[4]	2 screw mounting	M 2.5 or (2-56)		mm (in.)
	3 screw mounting	M 1.6 or (0-80)		mm (in.)
	external mounting ears	M 2.5 or (2-56)		mm (in.)
Encoder Base Plate Thickness		0.33 (0.130)		mm (in.)
Hub Set Screw		(2-56)		(in.)

Notes:

1. These are tolerances required of the user.
2. The HEDS-55x5 and 56x5, HEDM-5505, 5605 provide an 8.9 mm (0.35 inch) diameter hole through the housing for longer motor shafts. See Ordering Information.
3. The HEDS-5540 and 5640 must be aligned using the aligning pins as specified in Figure 3, or using the alignment tool as shown in "Encoder Mounting and Assembly". See also "Mounting Considerations."
4. The recommended mounting screw torque for 2 screw and external ear mounting is 1.0 kg-cm (0.88 in-lbs). The recommended mounting screw torque for 3 screw mounting is 0.50 kg-cm (0.43 in-lbs).

Electrical Interface

To insure reliable encoding performance, the HEDS-5540/5640 and HEDM-5540 three channel encoders require 2.7 k Ω (\pm 10%) pull-up resistors on output pins 2, 3, and 5 (Channels I, A, and B) as shown in Figure 1. These pull-up resistors should be located as close to the encoder as possible (within 4 feet). Each of the three encoder outputs can drive a single TTL load in this configuration. The HEDS-5500, 5600, and HEDM-5500, 5600 two channel encoders do not normally require pull-up resistors. However, 3.2 k Ω pull-up resistors on output pins 3 and 5 (Channels A and B) are recommended to improve rise times, especially when operating above 100 kHz frequencies.



Figure 1. Pull-up Resistors on HEDS-5x40 and HEDM-5540 Encoder Outputs.

Mounting Considerations

The HEDS-5540 and 5640 three channel encoders and the HEDM Series high resolution encoders must be aligned using the aligning pins as specified in Figure 3, or using the HEDS-8910 Alignment Tool as shown in Encoder Mounting and Assembly.

The use of aligning pins or alignment tool is recommended but not required to mount the HEDS-5500 and 5600. If these two channel encoders are attached to a motor with the screw sizes and mounting tolerances specified in the mechanical characteristics section without any additional mounting bosses, the encoder output errors will be within the maximums specified in the encoding characteristics section. The HEDS-5500 and 5540 can be mounted to a motor using either the two screw or three screw mounting option as shown in Figure 2. The optional aligning pins shown in Figure 3 can be used with either mounting option. The HEDS-5600, 5640, and HEDM-5600 have external mounting ears which may be used for mounting to larger motor base plates. Figure 4 shows the necessary mounting holes with optional aligning pins and motor boss.

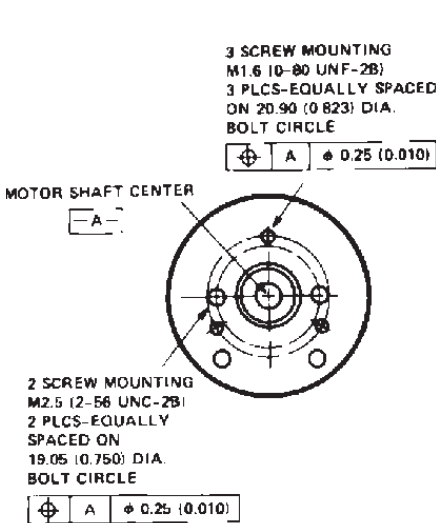

Figure 2. Mounting Holes.

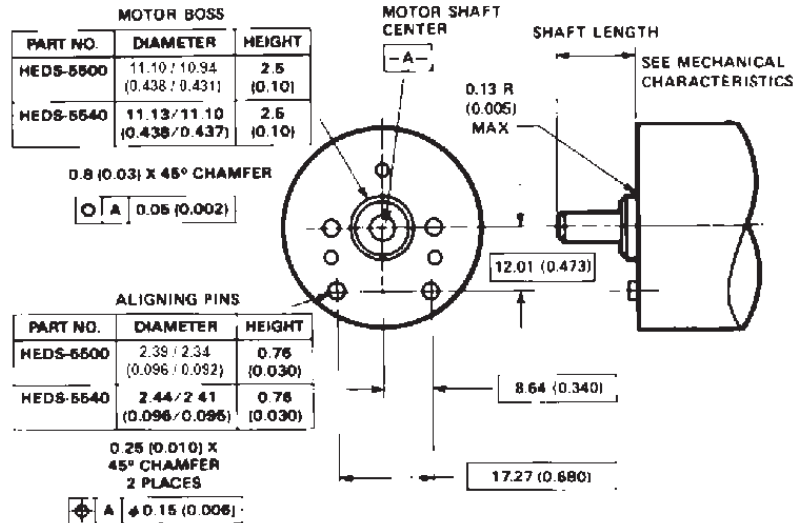

Figure 3. Optional Mounting Aids.



Figure 4. Mounting with External Ears.

Encoder Mounting and Assembly

- 1a. For HEDS-5500 and 5600: Mount encoder base plate onto motor. Tighten screws. Go on to step 2.
 - 1b. For HEDS-5540, 5640 and HEDM-5500, 5600, 5540 : Slip alignment tool onto motor shaft. With alignment tool in place, mount encoder baseplate onto motor as shown above. Tighten screws. Remove alignment tool.
 - 1c. It is recommended that adhesive* is applied to the screw-baseplate interface to prevent screw loosening due to effect of high temperature on plastic
 2. Snap encoder body onto base plate locking all 4 snaps.
 - 3a. Push the hex wrench into the body of the encoder to ensure that it is properly seated into the code wheel hub set screws. Then apply a downward force on the end of the hex wrench. This sets the code wheel gap by levering the code wheel hub to its upper position.
 - 3b. While continuing to apply a downward force, rotate the hex wrench in the clockwise direction until the hub set screw is tight against the motor shaft (The recommended torque to tighten the setscrew is 15-18 ozf.inch). The hub set screw attaches the code wheel to the motor's shaft.
 - 3c. Remove the hex wrench by pulling it straight out of the encoder body.
 4. Use the center screwdriver slot, or either of the two side slots, to rotate the encoder cap dot clockwise from the one dot position to the two dot position. Do not rotate the encoder cap counterclockwise beyond the one dot position.
- The encoder is ready for use!



Connectors

Manufacturer	Part Number
AMP	103686-4 640442-5
Avago (designed to mechanically lock into the HEDS-5XXX, HEDM-5X0X Series)	HEDS-8902 (2 ch.) with 4-wire leads HEDS-8903 (3 ch.) with 5-wire leads
Molex	2695 series with 2759 series term. Single ended cable connector P/N : 0050579405 and P/N : 0016020097.



Figure 5. HEDS-8902 and 8903 connectors

Protective Silicon Cover

Protective Silicon Rubber cover gives an extra protection for HEDS-5xx0 and HEDM-5xx0 family when operating in dusty environment.

The protective silicon cover is installed to HEDS-5xx0 or HEDM-5xx0 prior to the connector to the encoder is installed.

Part Number	HEDS-8907-001
Material	Silicon Rubber- Semi transparent-ESD protective material
Used With	HEDS-5xx0 and HEDM-5xx0
Temperature Range	-40°C to 100°C

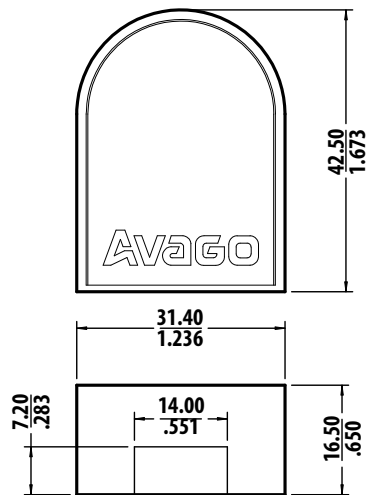

1. Dimensions are in $\frac{\text{millimeters}}{\text{Inches}}$
2. All tolerances are within ± 0.5

Typical Interfaces

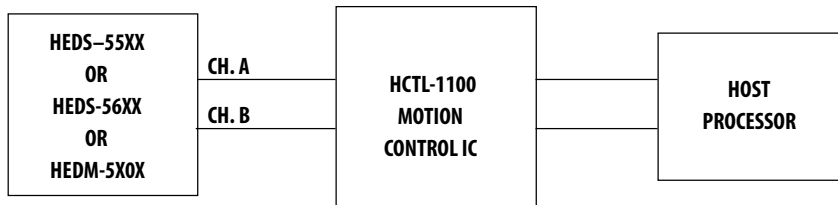
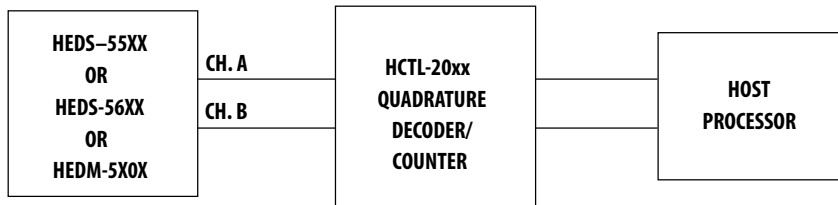

Ordering Information

Encoders with Film Codewheels

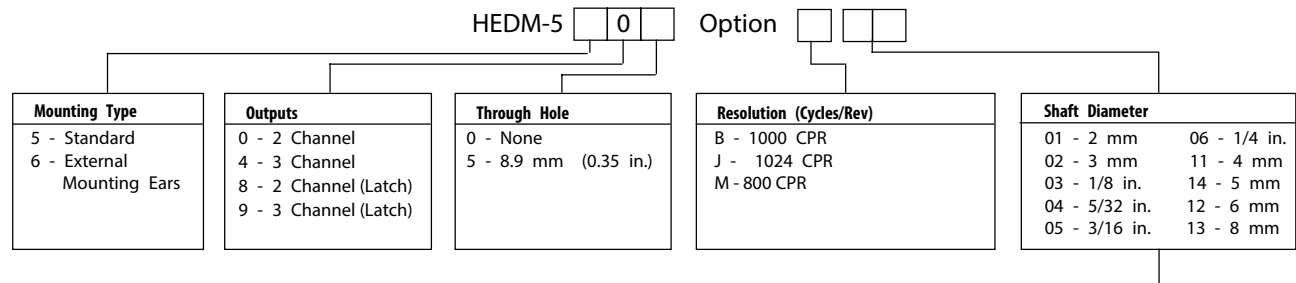

HEDS-8910 0 Alignment Tool

(Included with each order of HEDM-550X/560X two channel encoders and HEDM-554X three Channel encoders)

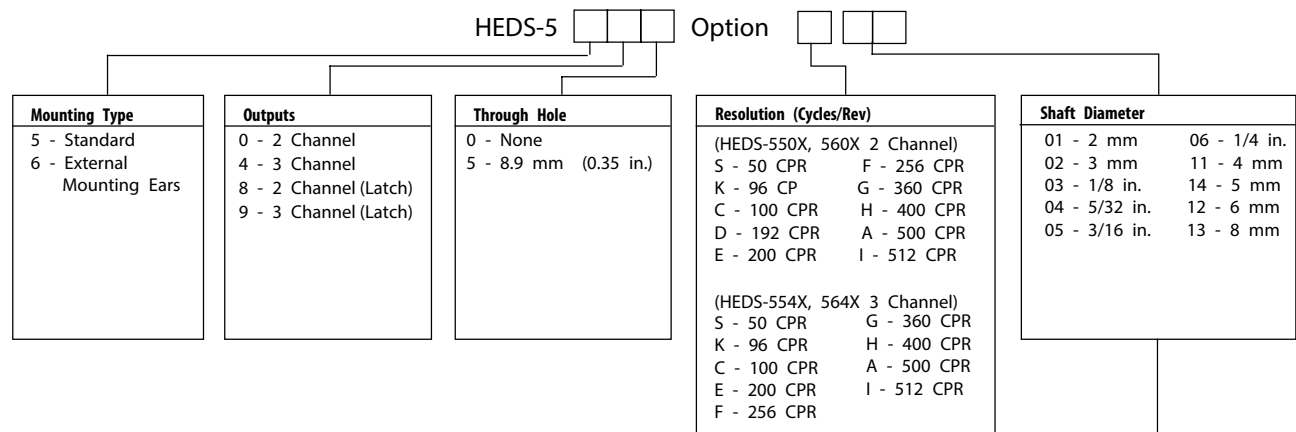

HEDS-8910 0 Alignment Tool

(Included with each order of HEDS-554X/564X three channel encoders)

		01	02	03	04	05	06	11	12	13	14
HEDM-5500	B	*	*				*	*	*	*	*
	J		*				*		*	*	*
HEDM-5505	B			*							
	J			*			*			*	
HEDM-5540	B	*	*		*			*		*	*
HEDM-5540	M						*				*
HEDM-5545	B									*	
HEDM-5600	B						*			*	
	J						*				
HEDM-5605	B						*				
	J						*				
HEDM-5640	M						*				*
HEDS-5500	A	*	*	*	*	*	*	*	*	*	*
	C	*	*	*	*	*	*	*	*	*	*
	E		*		*	*	*	*	*		*
	F	*	*		*	*	*	*	*		*
	G		*			*	*		*		*
	H					*	*		*		*
	I	*	*	*	*	*	*	*	*	*	*
	K				*	*	*	*			
	S										*
HEDS-5505	A				*		*			*	*
	C				*		*		*		*
	E				*		*				*
	F				*		*				*
	G				*		*				
	H						*				*
	I				*		*			*	
	K				*						
HEDS-5540	A	*	*	*	*	*	*	*	*	*	*
	C	*	*				*	*	*	*	*
	E						*	*	*		
	F	*						*			*
	G						*				
	H						*				*
	I	*	*				*	*	*	*	*

		01	02	03	04	05	06	11	12	13	14
HEDS-5545	A									*	*
	C									*	
	H						*				*
	I						*				
HEDS-5600	A						*		*	*	*
	C						*		*		*
	E						*				
	G						*			*	
	H						*		*		
	I	*						*			
HEDS-5605	A						*			*	
	C						*				
	E						*				
	F									*	
	G						*				
	H						*				*
	I						*				
HEDS-5640	A						*		*	*	
	E						*				
	F						*				
	H						*				
	I						*				
HEDS-5645	A						*		*	*	
	C									*	
	E									*	
	G									*	
	H						*		*		*
	I									*	

For product information and a complete list of distributors, please go to our web site: www.avagotech.com

Avago, Avago Technologies, and the A logo are trademarks of Avago Technologies in the United States and other countries. Data subject to change. Copyright © 2005-2014 Avago Technologies. All rights reserved. AV02-1046EN - November 20, 2014

