

# MGA-31389

## 0.1W High Gain Driver Amplifier

50MHz ~ 2GHz



# Data Sheet

### Description

Avago Technologies MGA-31389 is a high performance Driver Amplifier MMIC, housed in a standard SOT-89 plastic package. The device features flat high gain with excellent input and output return loss, as well as superior linearity performance. The device can be easily matched to obtain desired performance.

MGA-31389 is especially ideal for 50 Ω wireless infrastructure application within the 50 MHz to 2GHz frequency range applications. With high IP3 and low noise figure and wideband operation, the MGA-31389 may be utilized as a driver amplifier in the transmit chain and as a second stage LNA in the receiver chain.

This device uses Avago Technologies proprietary 0.25 μm GaAs Enhancement mode PHEMT process.

### Pin connections and Package Marking

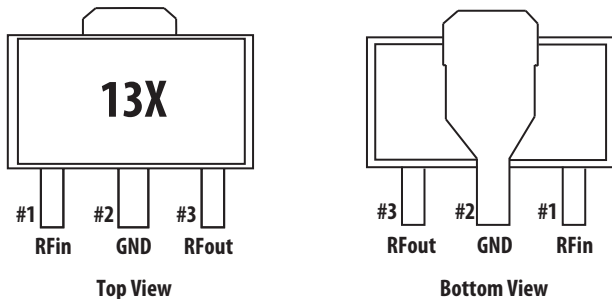

Note:

Package marking provides orientation and identification

"13" = Device Code

"X" = Date Code character identifies month of manufacturing



**Attention: Observe precautions for handling electrostatic sensitive devices.**  
ESD Machine Model = 75 V  
ESD Human Body Model = 1000 V  
Refer to Avago Application Note A004R:  
Electrostatic Discharge, Damage and Control.

### Features

- ROHS compliant
- Halogen free
- High IP3 at low DC bias power<sup>(1)</sup>
- High gain, with good gain flatness
- Low noise figure
- Advanced enhancement mode PHEMT Technology
- Excellent uniformity in product specification
- SOT-89 standard package

### Specifications

**At 0.9 GHz, Vd = 5 V, Id = 73 mA (typ) @ 25° C**

- OIP3 = 38.6 dBm
- Noise Figure = 2.0 dB
- Gain = 21.3 dB, Gain flatness (± 50 MHz) = 0.14 dB
- P1dB = 22.2 dBm
- IRL = 30.5 dB, ORL = 14.7 dB

Note:

1. The MGA-31389 has a superior LFOM of 13.3 dB. Linearity Figure of Merit (LFOM) is essentially OIP3 divided by DC bias power.

### Simplified Schematic

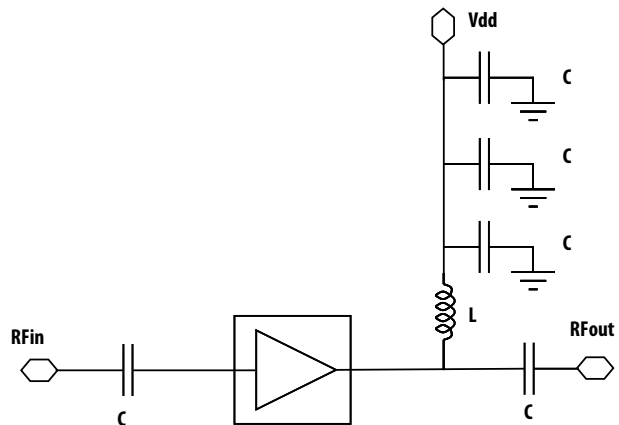

Figure 1. Simplified Schematic diagram

### MGA-31389 Absolute Maximum Rating <sup>(1)</sup> T<sub>A</sub>=25° C

Symbol	Parameter	Units	Absolute Max.
V <sub>d, max</sub>	Drain Voltage, RF output to ground	V	5.5
P <sub>d</sub>	Power Dissipation <sup>(2)</sup>	mW	605
P <sub>in</sub>	CW RF Input Power	dBm	20
T <sub>j</sub>	Junction Temperature	°C	150
T <sub>STG</sub>	Storage Temperature	°C	-65 to 150

### Thermal Resistance

#### Thermal Resistance <sup>(3)</sup>

(V<sub>d</sub> = 5.0 V, T<sub>c</sub> = 85° C, θ<sub>jc</sub> = 60.0° C/W)

Notes:

1. Operation of this device in excess of any of these limits may cause permanent damage.
2. Source lead temperature is 25° C. Derate 16.7 mW/° C for T<sub>L</sub>>128.0° C.
3. Thermal resistance measured using 150° C Infra-Red Microscopy Technique.

### MGA-31389 Electrical Specification <sup>(1)</sup>

T<sub>C</sub> = 25° C, V<sub>d</sub> = 5 V, unless noted

Symbol	Parameter and Test Condition	Frequency	Units	Min.	Typ.	Max.
I <sub>ds</sub>	Quiescent Current	N/A	mA	62	73	90
NF	Noise Figure	0.45 GHz 0.9 GHz 1.5 GHz	dB	-	2.3 2.0 2.0	2.5
Gain	Gain	0.45 GHz 0.9 GHz 1.5 GHz	dB	20	21.5 21.3 20.6	23
OIP3 <sup>(2)</sup>	Output Third Order Intercept Point	0.45 GHz <sup>(2)</sup> 0.9 GHz <sup>(2)</sup> 1.5 GHz <sup>(2)</sup>	dBm	36.3	38.6 38.6 41.3	-
P1dB	Output Power at 1 dB Gain Compression	0.45 GHz 0.9 GHz 1.5 GHz	dBm	20.6	22.0 22.2 21.7	-
PAE	Power Added Efficiency at P1dB	0.45 GHz 0.9 GHz 1.5 GHz	%	-	41.0 41.2 38.4	-
IRL	Input Return Loss	0.45 GHz 0.9 GHz 1.5 GHz	dB	-	24.3 30.5 15.3	-
ORL	Output Return Loss	0.45 GHz 0.9 GHz 1.5 GHz	dB	-	11.4 14.7 12.1	-
ISOL	Isolation	0.45 GHz 0.9 GHz 1.5 GHz	dB	-	27.2 27.6 28.6	-

Note :

1. Measurements obtained from a test circuit described in Figure 34
2. OIP3 test condition: F1 - F2 = 10 MHz, with input power of -14 dBm per tone measured at worst case side band.

## MGA-31389 Consistency Distribution Chart (1,2)

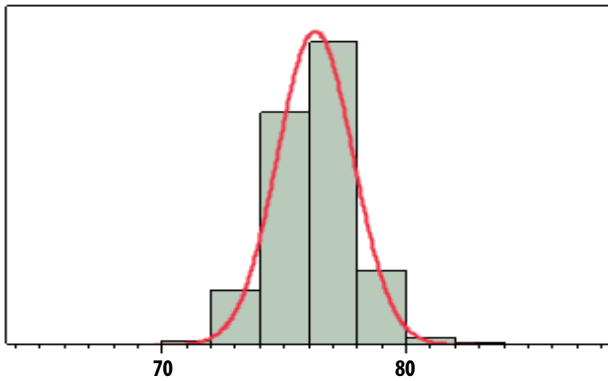

Figure 2. Id @ 900MHz, Vd=5V, LSL=62mA, Nominal=76mA, USL=90mA

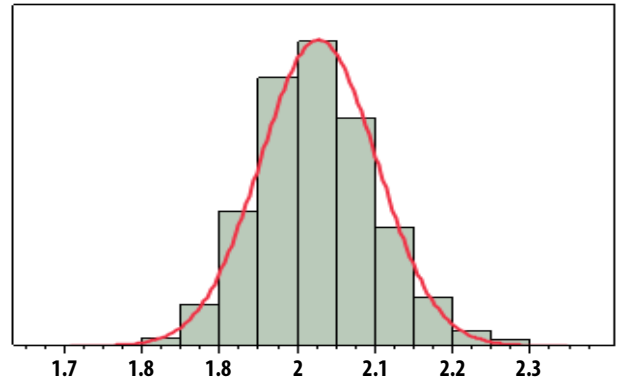

Figure 3. NF @ 900MHz, Vd=5V, Nominal=2.0dB, USL=2.5dB

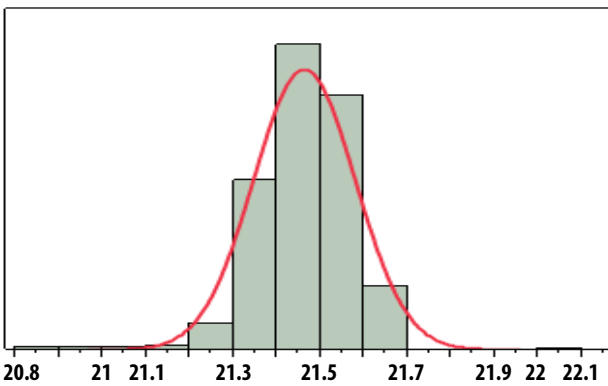

Figure 4. Gain @ 900MHz, Vd=5V, LSL=20dB, Nominal=21.5dB, USL=23dB

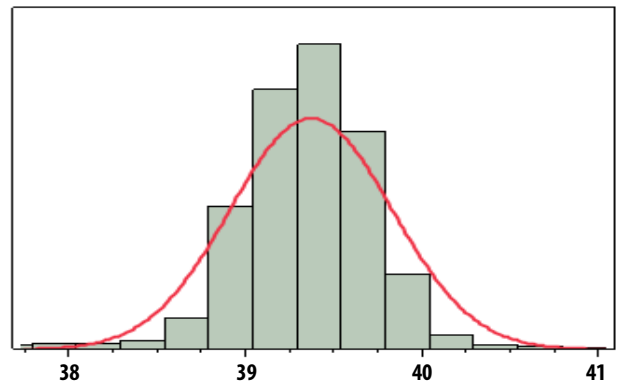

Figure 5. OIP3 @ 900MHz, Vd=5V, LSL=36.3dBm, Nominal=39.3dBm

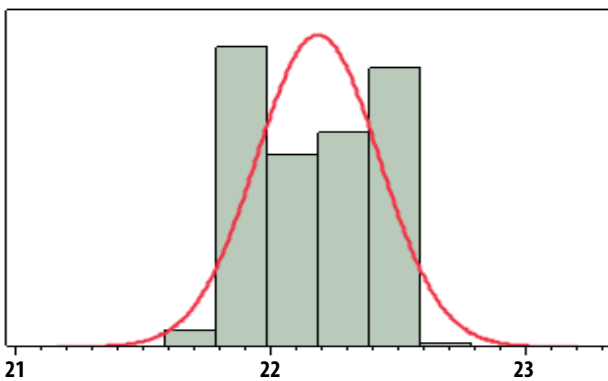

Figure 6. P1dB @ 900MHz, Vd=5V, LSL= 20.6dBm, Nominal=22.2dBm

### Notes:

1. Data sample size is 3000 samples taken from 3 different wafers and 2 different lots. Future wafers allocated to this product may have nominal values anywhere between the upper and lower limits.
2. Measurements are made on production test board which represents a trade-off between optimal Gain, NF, OIP3 and OP1dB. Circuit losses have been de-embedded from actual measurements.

# MGA-31389 Application Circuit Data for 450 MHz

$T_c = 25^\circ\text{C}$ ,  $V_d = 5.0\text{V}$ ,  $I_d = 73\text{mA}$

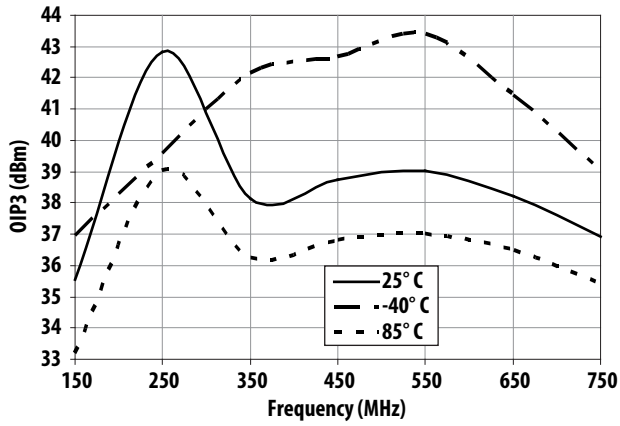

Figure 7. OIP3 vs Frequency and Temperature

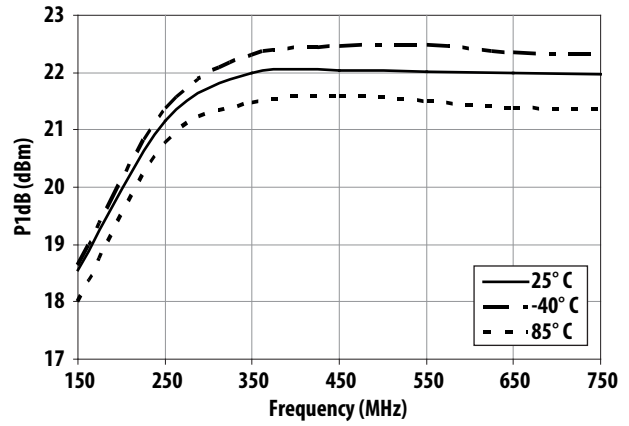

Figure 8. P1dB vs Frequency and Temperature

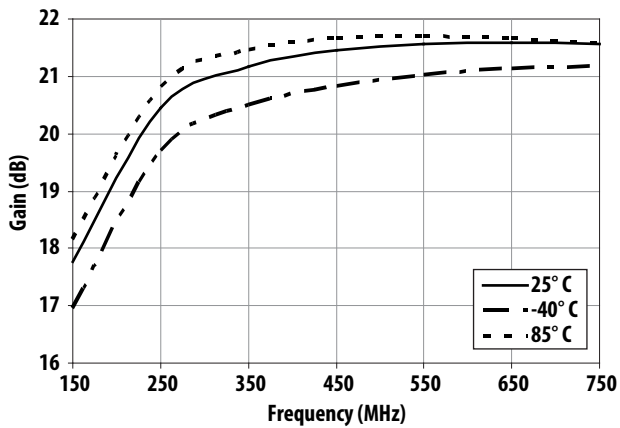

Figure 9. Gain vs Frequency and Temperature

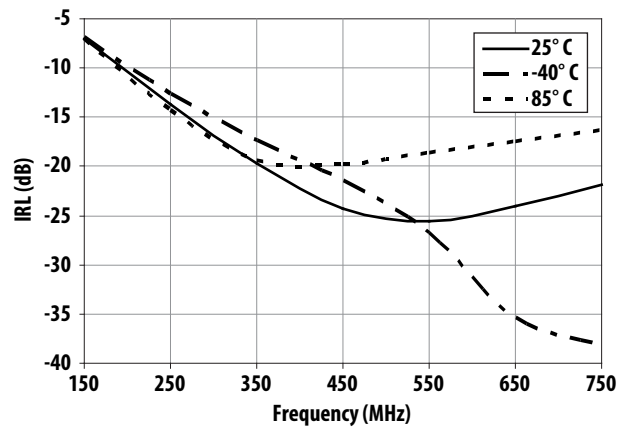

Figure 10. IRL vs Frequency and Temperature

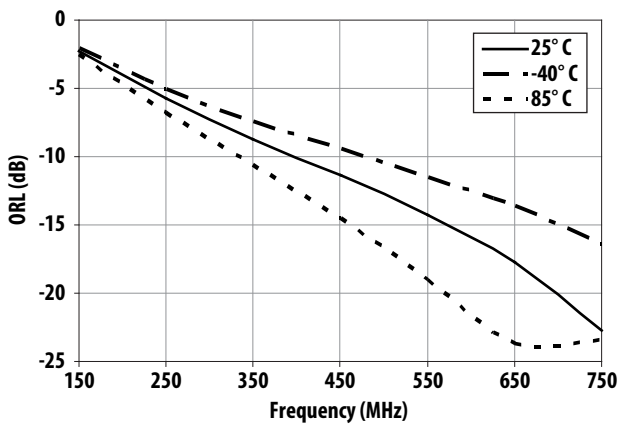

Figure 11. ORL vs Frequency and Temperature

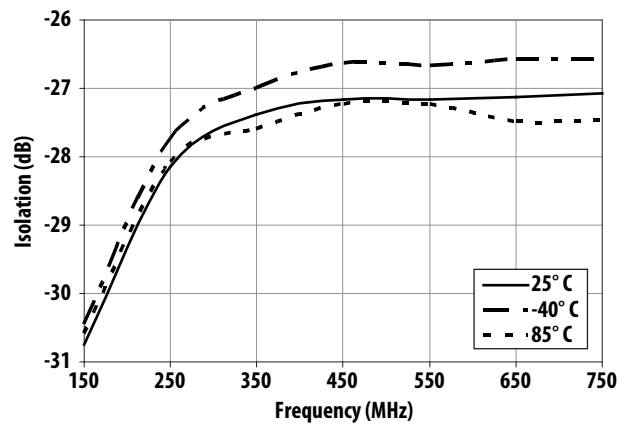

Figure 12. Isolation vs Frequency and Temperature

## MGA-31389 Application Circuit Data for 450 MHz (cont'd)

$T_c = 25^\circ\text{C}$ ,  $V_d = 5.0\text{ V}$ ,  $I_d = 73\text{ mA}$

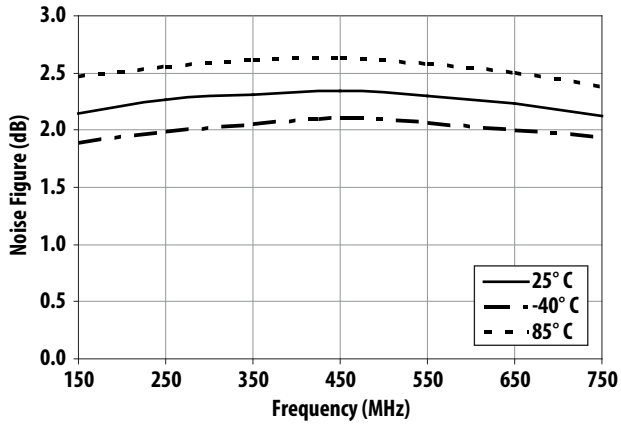

Figure 13. Noise Figure vs Frequency and Temperature

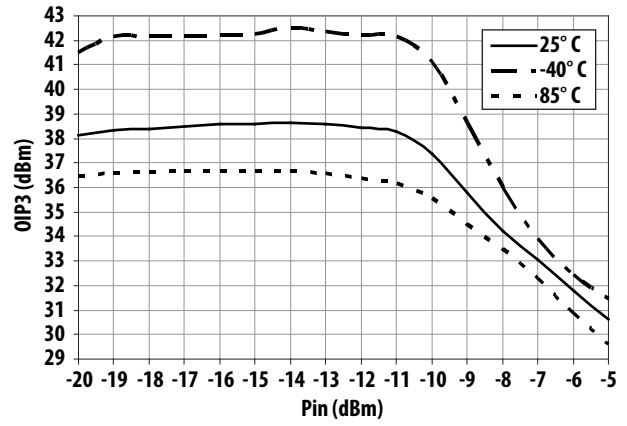

Figure 14. OIP3 vs Input Power and Temperature

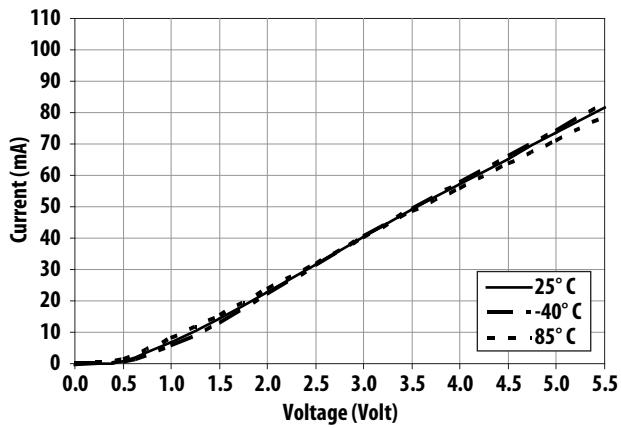

Figure 15. Current vs Voltage and Temperature

# MGA-31389 Application Circuit Data for 900 MHz

$T_c = 25^\circ\text{C}$ ,  $V_d = 5.0\text{V}$ ,  $I_d = 73\text{mA}$

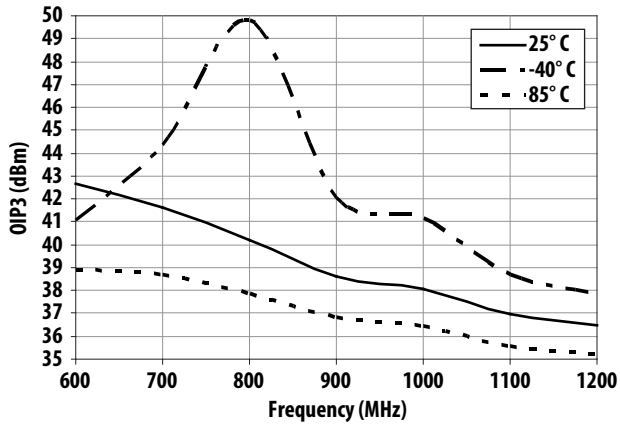

Figure 16. OIP3 vs Frequency and Temperature

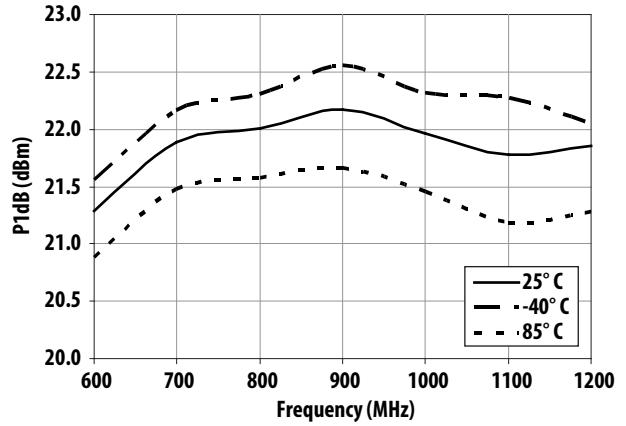

Figure 17. P1dB vs Frequency and Temperature

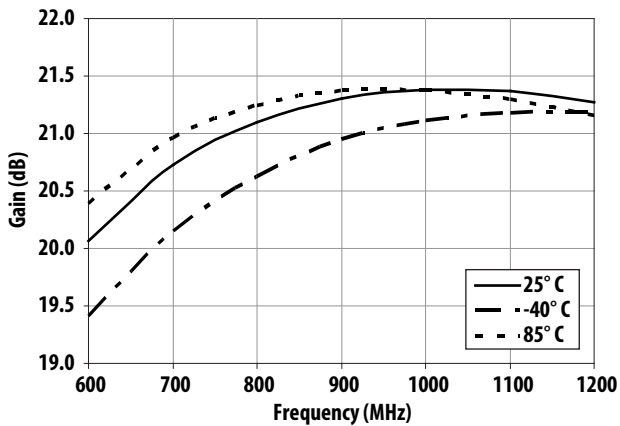

Figure 18. Gain vs Frequency and Temperature

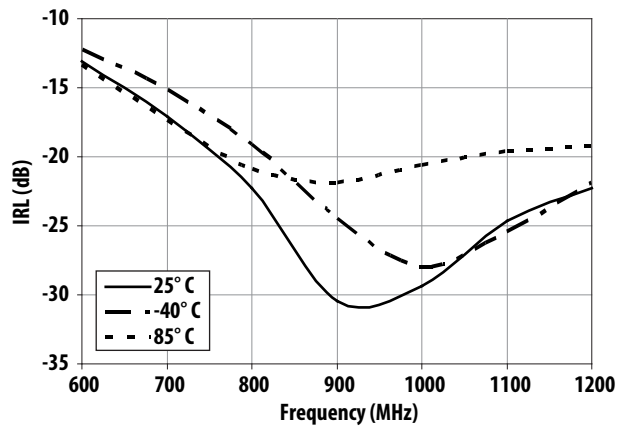

Figure 19. IRL vs Frequency and Temperature

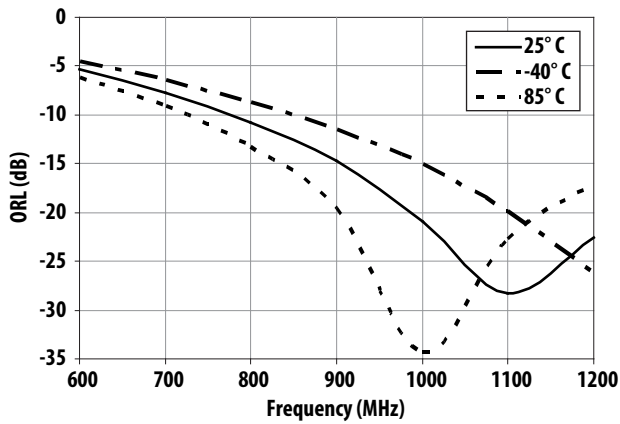

Figure 20. ORL vs Frequency and Temperature

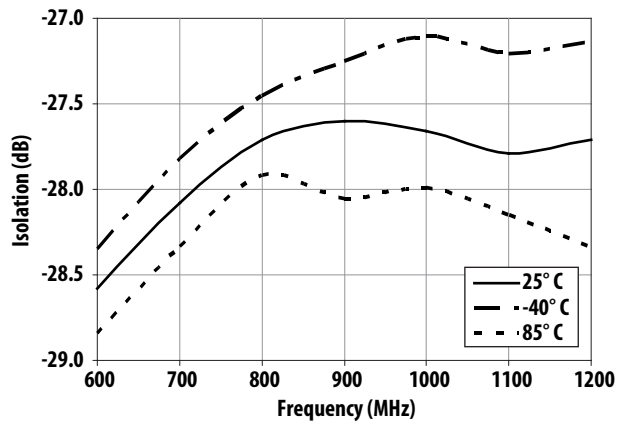

Figure 21. Isolation vs Frequency and Temperature

### MGA-31389 Application Circuit Data for 900 MHz (cont'd)

$T_c = 25^\circ\text{C}$ ,  $V_d = 5.0\text{ V}$ ,  $I_d = 73\text{ mA}$

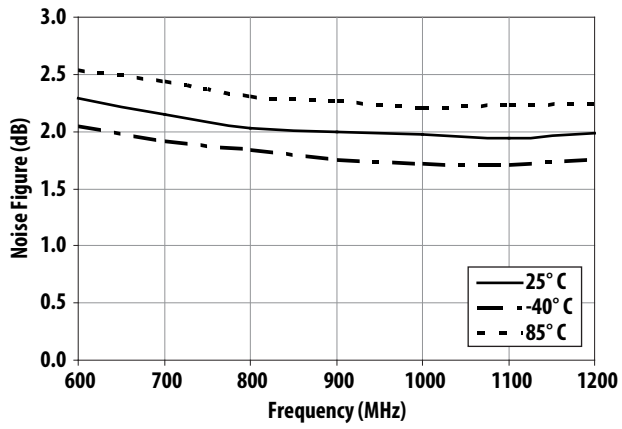

Figure 22. Noise Figure vs Frequency and Temperature

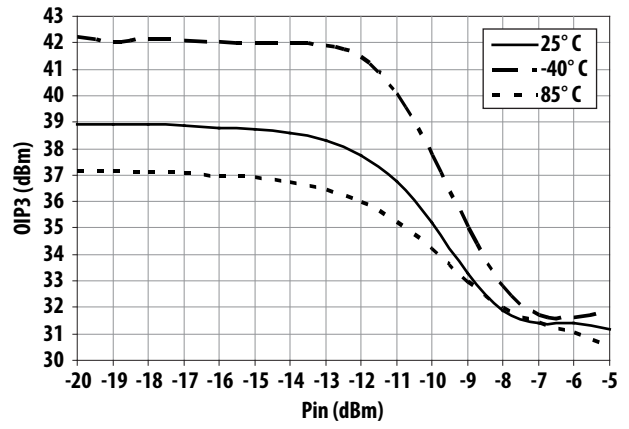

Figure 23. OIP3 vs Input Power and Temperature

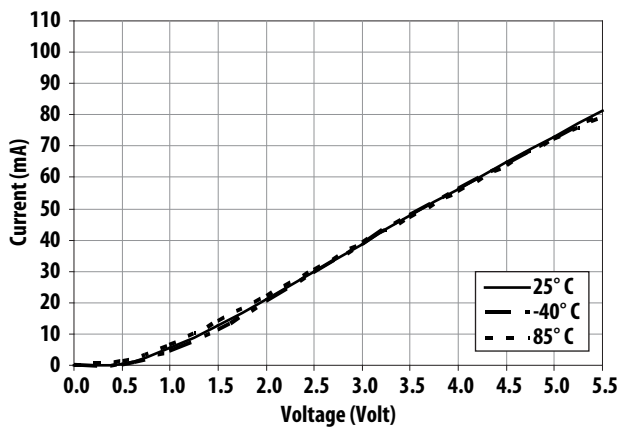

Figure 24. Current vs Voltage and Temperature

# MGA-31389 Application Circuit Data for 1500MHz

$T_c = 25^\circ\text{C}$ ,  $V_d = 5.0\text{V}$ ,  $I_d = 73\text{mA}$

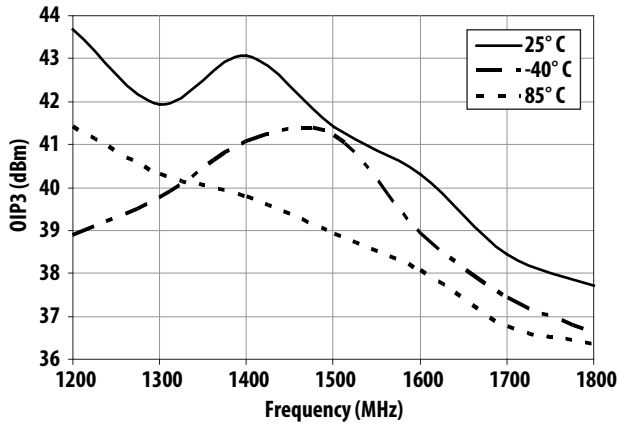

Figure 25. OIP3 vs Frequency and Temperature

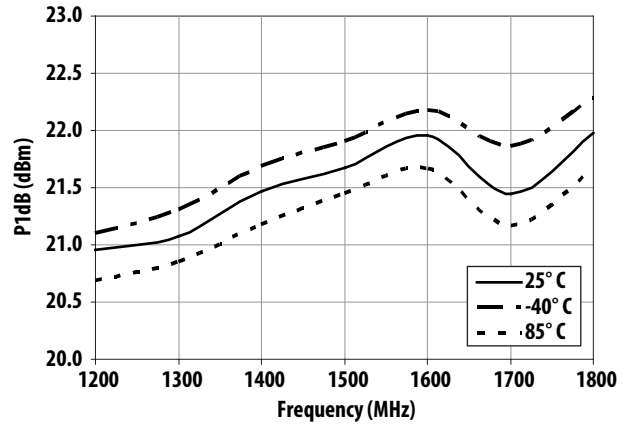

Figure 26. P1dB vs Frequency and Temperature

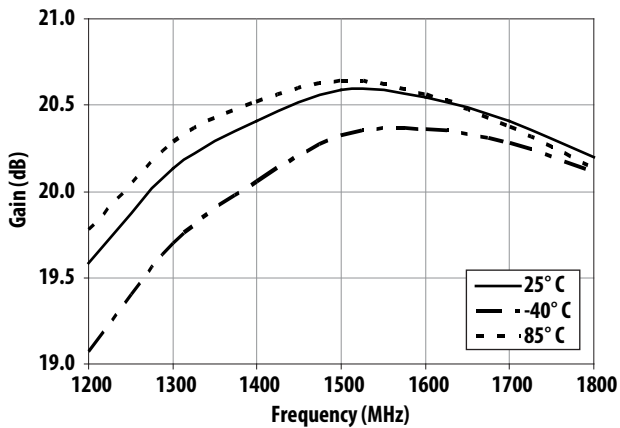

Figure 27. Gain vs Frequency and Temperature

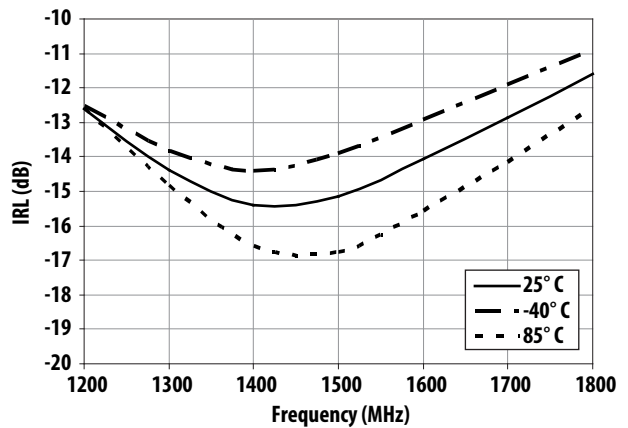

Figure 28. IRL vs Frequency and Temperature

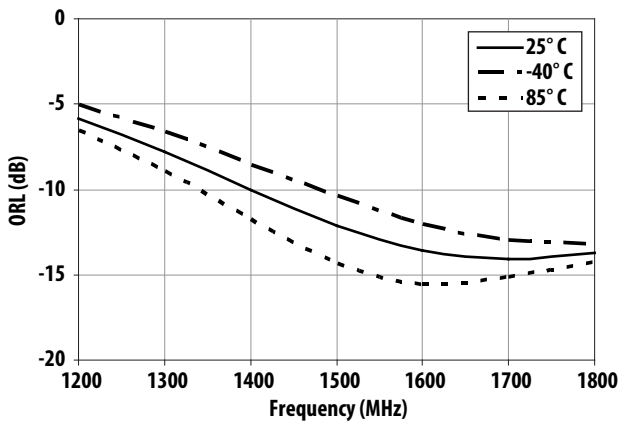

Figure 29. ORL vs Frequency and Temperature

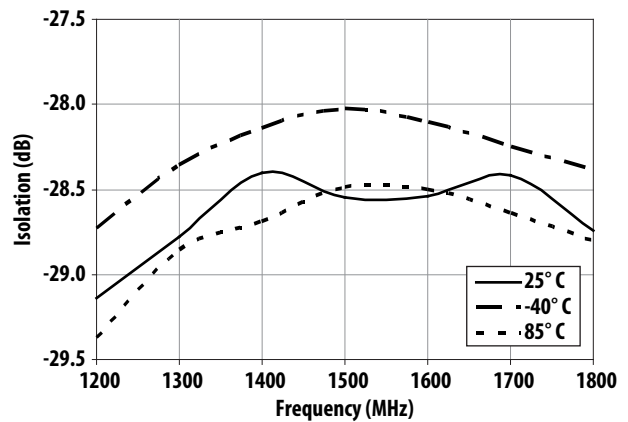

Figure 30. Isolation vs Frequency and Temperature



### MGA-31389 Application Circuit Data for 1500 MHz (cont'd)

$T_c = 25^\circ\text{C}$ ,  $V_d = 5.0\text{V}$ ,  $I_d = 73\text{mA}$

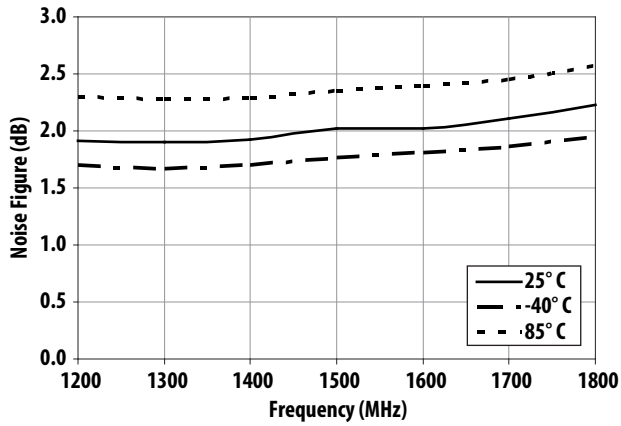

Figure 31. Noise Figure vs Frequency and Temperature

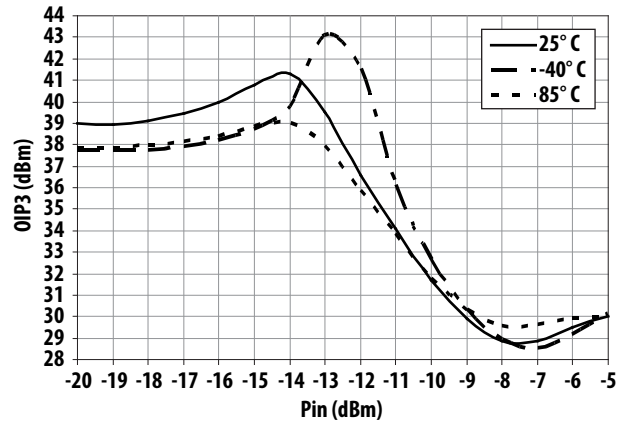

Figure 32. OIP3 vs Input Power and Temperature

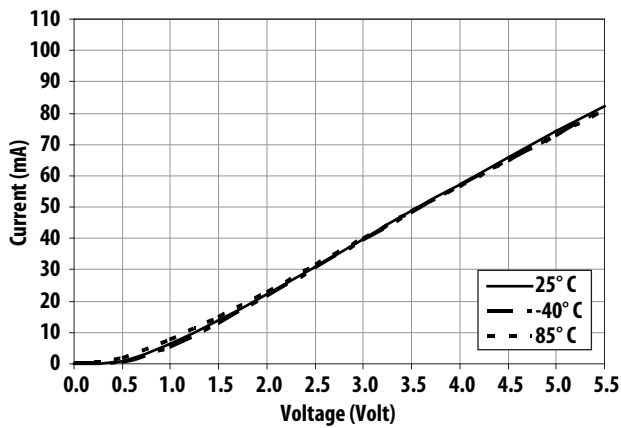

Figure 33. Current vs Voltage and Temperature

## Application Circuit Description and Layout

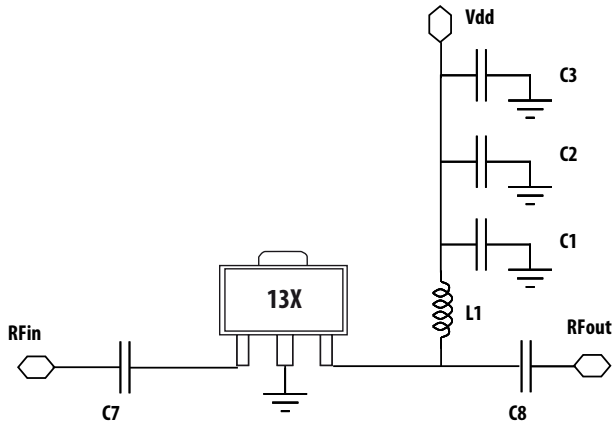

Figure 34. Circuit diagram

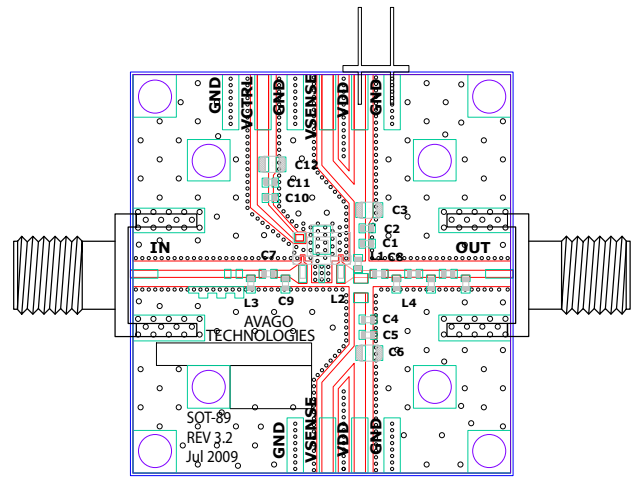

Figure 35. Demoboard

## Bill of Materials

Circuit Symbol	Size	Description					
		For 0.45 GHz <sup>(1)</sup>		For 0.9 GHz <sup>(2)</sup>		For 1.5 GHz <sup>(3)</sup>	
		Value	Manufacturer	Value	Manufacturer	Value	Manufacturer
C1	0402	10 pF	Murata	3.0 pF	Murata	3.9 pF	Murata
C2	0402	0.1 μF	Murata	0.1 μF	Murata	0.1 μF	Murata
C3	0603	2.2 μF	Murata	2.2 μF	Murata	2.2 μF	Murata
C7	0402	100 pF	Murata	100 pF	Murata	100 pF	Murata
C8	0402	15 pF	Murata	5.6 pF	Murata	3 pF	Murata
L1	0402	39 nH	Murata	12 nH	Murata	3.9 nH	Murata

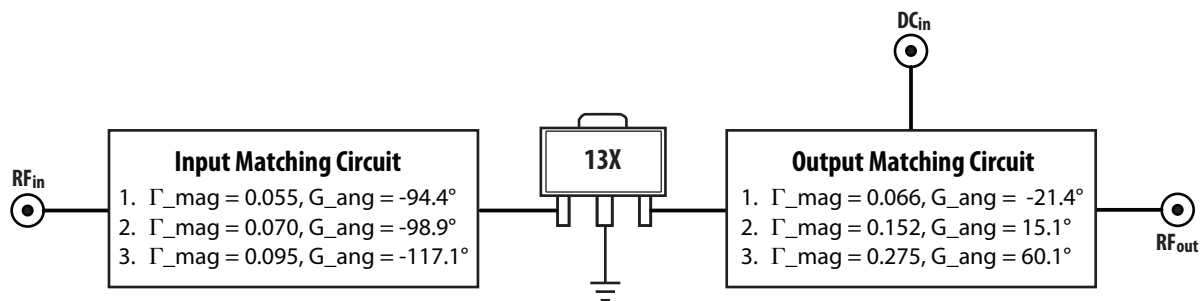

Figure 36. Input and output tuned Gamma location for 450MHz <sup>(1)</sup>, 900MHz <sup>(2)</sup> and 1500MHz <sup>(3)</sup>

For best performance, MGA-31389 is an input and output prematched driver amplifier. To bias MGA-31389, a +5V supply (Vdd) is connected to the output pin through a RF choke, L1 (which isolates the inband signal from the DC supply). The bypass capacitor helps to eliminate out of low band frequency signals from the power supply, C3, C2 and C1. Blocking capacitors are required for its input (C7) and output (C8), to isolate the supply voltage from preceding and succeeding circuits. C7 also plays a part in input tuning to improve input return loss while L1 and C8 help in tuning output. The recommended output tuning is for achieving best OIP3, while meeting typical specifications for other parameters.

### MGA-31389 Typical Scatter Parameters (1)

$T_c = 25^\circ\text{C}$ ,  $V_d = 5.0\text{V}$ ,  $I_d = 73\text{mA}$ ,  $Z_o = 50\ \Omega$

Freq GHz	S11	S11	S11	S21	S21	S21	S12	S12	S12	S22	S22	S22	K Factor
	Mag.	dB	Ang.	Mag.	dB	Ang.	Mag.	dB	Ang.	Mag.	dB	Ang.	
0.10	0.046	-26.7	-127.5	12.372	21.8	169.8	0.046	-26.8	-3.3	0.281	-11.0	172.9	1.100
0.20	0.034	-29.4	-146.1	12.409	21.9	162.4	0.046	-26.7	-9.9	0.270	-11.4	160.6	1.104
0.30	0.032	-29.9	-150.7	12.415	21.9	154.2	0.046	-26.7	-15.9	0.258	-11.8	149.5	1.108
0.40	0.035	-29.0	-146.0	12.406	21.9	145.8	0.046	-26.8	-21.9	0.240	-12.4	138.9	1.117
0.50	0.040	-27.9	-138.6	12.386	21.9	137.2	0.046	-26.8	-27.8	0.216	-13.3	128.8	1.130
0.60	0.047	-26.5	-135.8	12.350	21.8	128.6	0.045	-26.9	-33.7	0.189	-14.5	118.3	1.143
0.70	0.053	-25.5	-137.3	12.308	21.8	119.8	0.045	-27.0	-39.6	0.161	-15.9	107.3	1.158
0.80	0.057	-24.8	-141.8	12.247	21.8	111.1	0.044	-27.0	-45.6	0.133	-17.5	95.1	1.174
0.90	0.059	-24.5	-149.0	12.179	21.7	102.2	0.044	-27.2	-51.5	0.106	-19.5	81.1	1.192
1.00	0.058	-24.8	-158.8	12.092	21.7	93.4	0.043	-27.3	-57.6	0.081	-21.8	63.4	1.211
1.10	0.051	-25.8	-168.3	12.003	21.6	84.5	0.043	-27.4	-63.3	0.067	-23.5	39.1	1.230
1.20	0.042	-27.6	170.5	11.913	21.5	75.4	0.042	-27.5	-69.2	0.054	-25.3	10.9	1.248
1.30	0.035	-29.1	131.7	11.805	21.4	66.2	0.041	-27.7	-75.2	0.049	-26.3	-21.3	1.266
1.40	0.042	-27.5	83.8	11.686	21.4	56.9	0.041	-27.8	-81.2	0.052	-25.7	-53.4	1.282
1.50	0.067	-23.5	50.5	11.545	21.2	47.4	0.040	-27.9	-87.4	0.060	-24.4	-78.5	1.298
1.60	0.102	-19.9	28.8	11.382	21.1	37.7	0.040	-28.0	-93.6	0.070	-23.1	-98.5	1.311
1.70	0.143	-16.9	12.1	11.165	21.0	27.8	0.039	-28.2	-100.3	0.080	-22.0	-114.8	1.324
1.80	0.189	-14.5	-2.8	10.908	20.8	17.9	0.039	-28.3	-107.1	0.089	-21.0	-128.9	1.335
1.90	0.240	-12.4	-16.6	10.600	20.5	7.7	0.038	-28.4	-114.4	0.096	-20.3	-141.7	1.348
2.00	0.292	-10.7	-30.0	10.230	20.2	-2.5	0.037	-28.6	-121.8	0.102	-19.8	-153.3	1.364
2.10	0.346	-9.2	-43.5	9.831	19.9	-12.8	0.036	-28.8	-129.5	0.107	-19.4	-164.5	1.384
2.20	0.398	-8.0	-56.6	9.365	19.4	-23.1	0.035	-29.1	-137.6	0.108	-19.3	-175.7	1.411
2.30	0.450	-6.9	-69.7	8.862	19.0	-33.4	0.034	-29.4	-145.7	0.107	-19.4	174.4	1.447
2.40	0.501	-6.0	-82.4	8.323	18.4	-43.6	0.033	-29.7	-154.1	0.104	-19.7	165.1	1.489
2.50	0.549	-5.2	-94.7	7.764	17.8	-53.5	0.031	-30.1	-162.4	0.098	-20.1	156.7	1.546
3.00	0.744	-2.6	-148.3	5.017	14.0	-99.1	0.023	-32.8	157.6	0.040	-27.9	148.5	1.973
3.50	0.853	-1.4	174.9	3.042	9.7	-135.2	0.017	-35.6	124.7	0.089	-21.0	-133.1	2.645
4.00	0.900	-0.9	150.2	1.908	5.6	-163.5	0.014	-37.2	98.7	0.195	-14.2	-142.0	3.446
5.00	0.908	-0.8	105.9	0.945	-0.5	147.1	0.014	-37.2	55.9	0.328	-9.7	-167.2	6.072
6.00	0.903	-0.9	41.9	0.502	-6.0	91.2	0.016	-36.0	9.0	0.340	-9.4	156.6	10.230
7.00	0.943	-0.5	-1.6	0.240	-12.4	42.9	0.015	-36.5	-28.8	0.431	-7.3	112.4	12.763
8.00	0.958	-0.4	-16.7	0.131	-17.7	5.7	0.014	-37.1	-55.2	0.509	-5.9	71.7	16.973
9.00	0.938	-0.6	-38.6	0.082	-21.8	-33.5	0.013	-37.9	-83.4	0.546	-5.3	29.8	40.810
10.00	0.941	-0.5	-75.0	0.045	-26.9	-76.8	0.009	-41.2	-117.9	0.610	-4.3	-16.1	92.313
11.00	0.961	-0.3	-101.8	0.020	-33.8	-108.6	0.003	-49.3	-143.7	0.740	-2.6	-49.3	245.787
12.00	0.974	-0.2	-116.2	0.009	-41.4	-122.2	0.000	-68.3	-14.2	0.824	-1.7	-66.2	2552.738
13.00	0.969	-0.3	-127.3	0.004	-49.0	-108.5	0.003	-49.4	-6.7	0.839	-1.5	-85.5	746.065
14.00	0.951	-0.4	-145.5	0.004	-48.2	-63.1	0.006	-43.8	-28.7	0.836	-1.6	-115.5	573.063
15.00	0.956	-0.4	-168.7	0.006	-44.3	-70.1	0.008	-41.9	-57.1	0.871	-1.2	-144.7	211.605
16.00	0.966	-0.3	178.6	0.006	-45.1	-101.7	0.007	-43.5	-89.3	0.910	-0.8	-158.6	153.352
17.00	0.966	-0.3	171.8	0.002	-53.8	-69.5	0.003	-49.9	-64.3	0.924	-0.7	-162.9	749.036
18.00	0.949	-0.5	158.3	0.004	-49.1	-14.3	0.004	-47.2	-27.6	0.906	-0.9	-170.2	587.481
19.00	0.946	-0.5	139.4	0.007	-42.5	-13.5	0.008	-42.1	-21.2	0.852	-1.4	171.1	244.925
20.00	0.947	-0.5	125.2	0.012	-38.7	-17.0	0.012	-38.7	-21.6	0.822	-1.7	145.1	122.769

### MGA-31389 K-Factor (1)

$T_c = 25^\circ\text{C}$ ,  $V_d = 5.0\text{ V}$ ,  $I_d = 73\text{ mA}$ ,  $Z_o = 50\ \Omega$

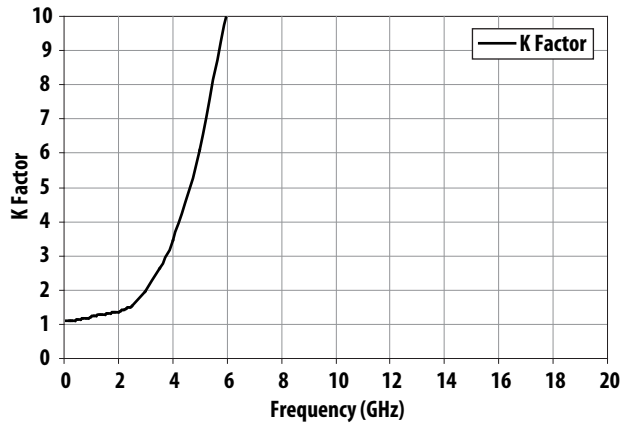

### MGA-31389 Typical Noise Parameters (1)

$T_c = 25^\circ\text{C}$ ,  $V_d = 5.0\text{ V}$ ,  $I_d = 73\text{ mA}$ ,  $Z_o = 50\ \Omega$

Freq (GHz)	$F_{min}$ (dB)	$\Gamma_{opt}$ Mag	$\Gamma_{opt}$ Ang	$R_n/Z_o$	Ga (dB)
0.5	2.08	0.204	4.8	0.34	22.11
0.8	1.85	0.247	20.6	0.33	21.73
0.9	1.71	0.312	6.2	0.36	21.44
1	1.75	0.309	18.7	0.36	21.38
1.5	1.90	0.264	20.6	0.31	21.06
2	2.24	0.254	90.3	0.28	20.27
2.5	2.35	0.470	118.8	0.28	18.99
3	2.88	0.601	157.6	0.13	16.91
3.5	3.53	0.714	-173.1	0.08	14.77
4	5.03	0.769	-148.1	0.49	12.19
4.5	7.91	0.855	-124.3	3.88	10.11
5	7.65	0.883	-103.0	7.78	7.38
5.5	8.82	0.868	-80.5	18.35	4.51
6	10.27	0.929	-56.6	41.09	2.21

Note:

1. Measurements are made using 10 mils Rogers RO4350 TRL Board.

## Part Number Ordering Information

Part Number	No. of Devices	Container
MGA-31389-BLKG	100	7" Tape/Reel
MGA-31389-TR1G	3000	13" Tape/Reel

## SOT89 Package Dimensions

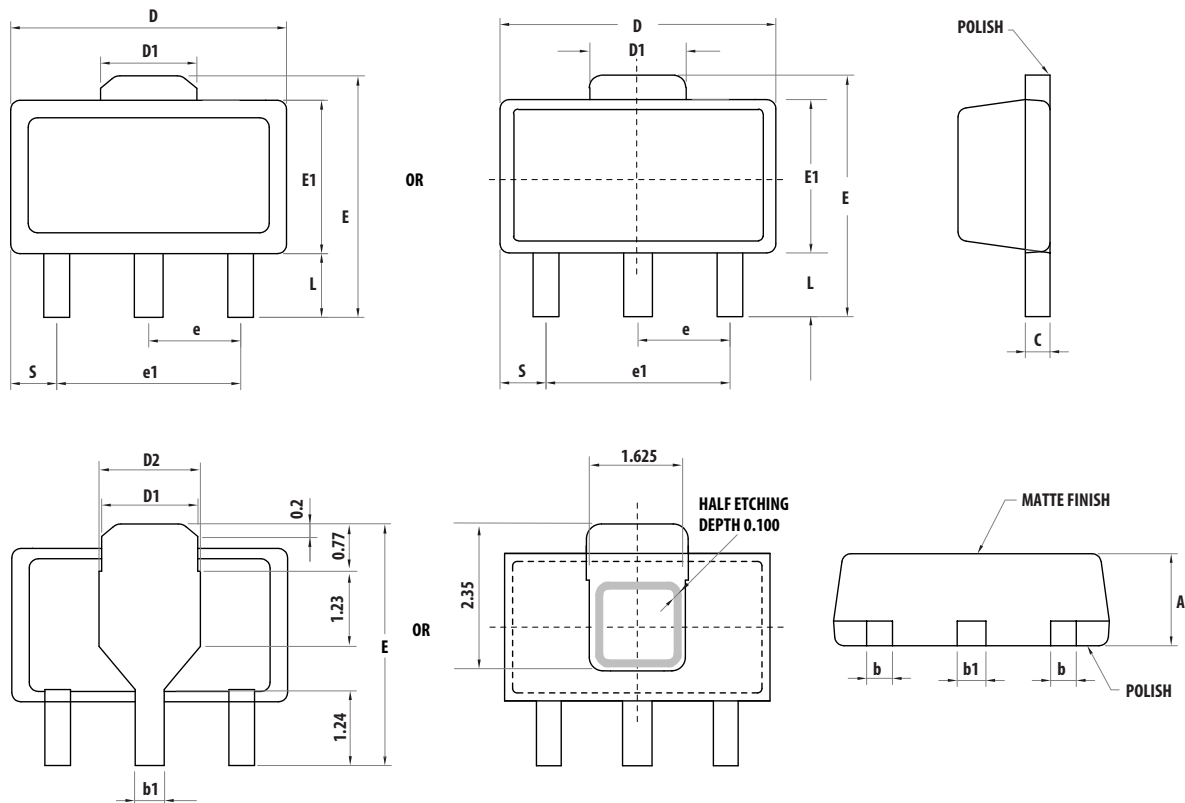

Symbols	Dimensions in mm			Dimensions in inches		
	Minimum	Nominal	Maximum	Minimum	Nominal	Maximum
A	1.40	1.50	1.60	0.055	0.059	0.063
L	0.89	1.04	1.20	0.0350	0.041	0.047
b	0.36	0.42	0.48	0.014	0.016	0.018
b1	0.41	0.47	0.53	0.016	0.018	0.030
C	0.38	0.40	0.43	0.014	0.015	0.017
D	4.40	4.50	4.60	0.173	0.177	0.181
D1	1.40	1.60	1.75	0.055	0.062	0.069
D2	1.45	1.65	1.80	0.055	0.062	0.069
E	3.94	-	4.25	0.155	-	0.167
E1	2.40	2.50	2.60	0.094	0.098	0.102
e1	2.90	3.00	3.10	0.114	0.118	0.122
S	0.65	0.75	0.85	0.026	0.030	0.034
e	1.40	1.50	1.60	0.054	0.059	0.063

## Device Orientation

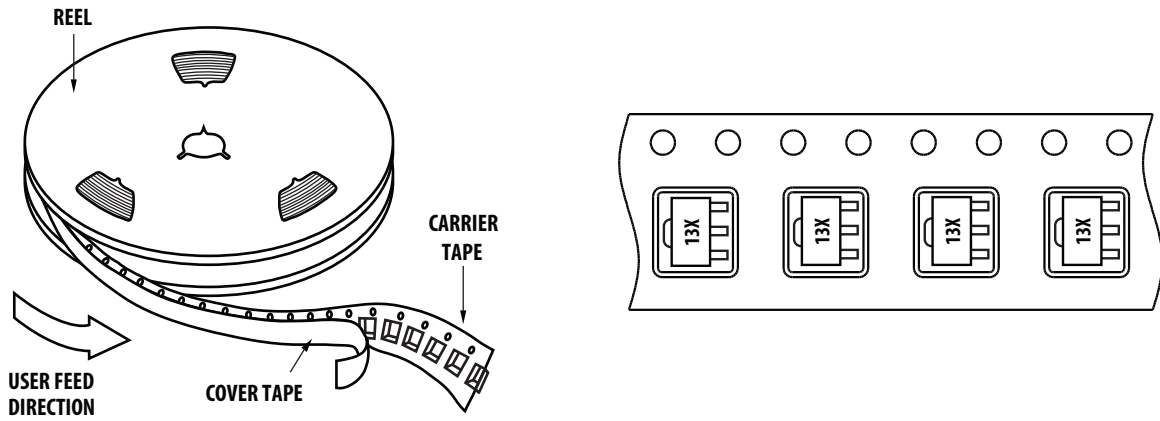

## Tape Dimensions

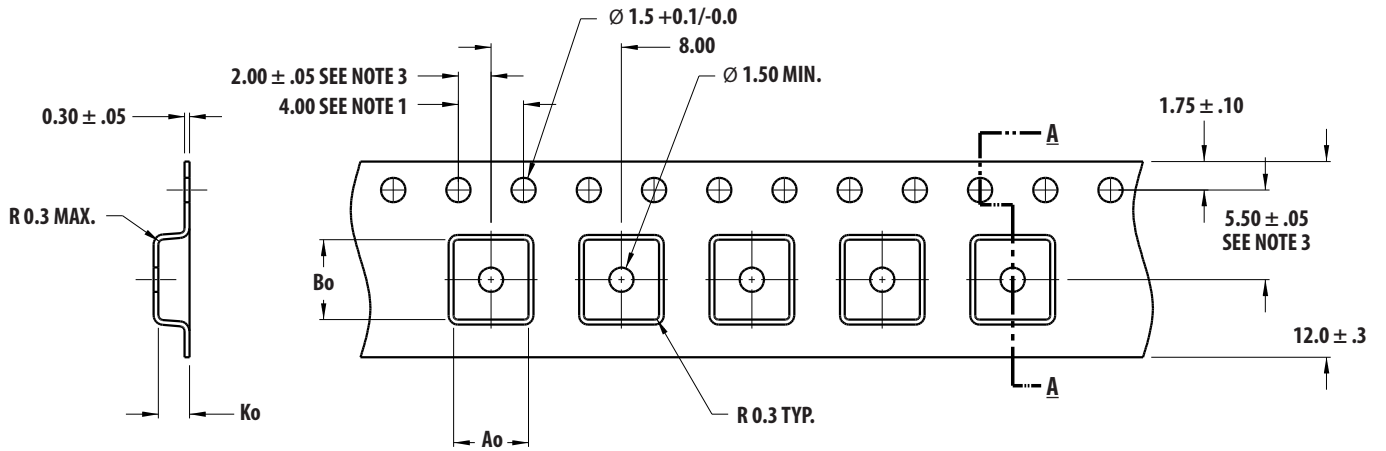

### SECTION A - A

Ao = 4.60  
Bo = 4.90  
Ko = 1.90

### DIMENSIONS IN MM

#### NOTES:

1. 10 SPROCKET HOLE PITCH CUMULATIVE TOLERANCE  $\pm 0.2$
2. CAMBER IN COMPLIANCE WITH EIA 481
3. POCKET POSITION RELATIVE TO SPROCKET HOLE MEASURED AS TRUE POSITION OF POCKET, NOT POCKET HOLE

# Reel Dimensions – 13" Reel

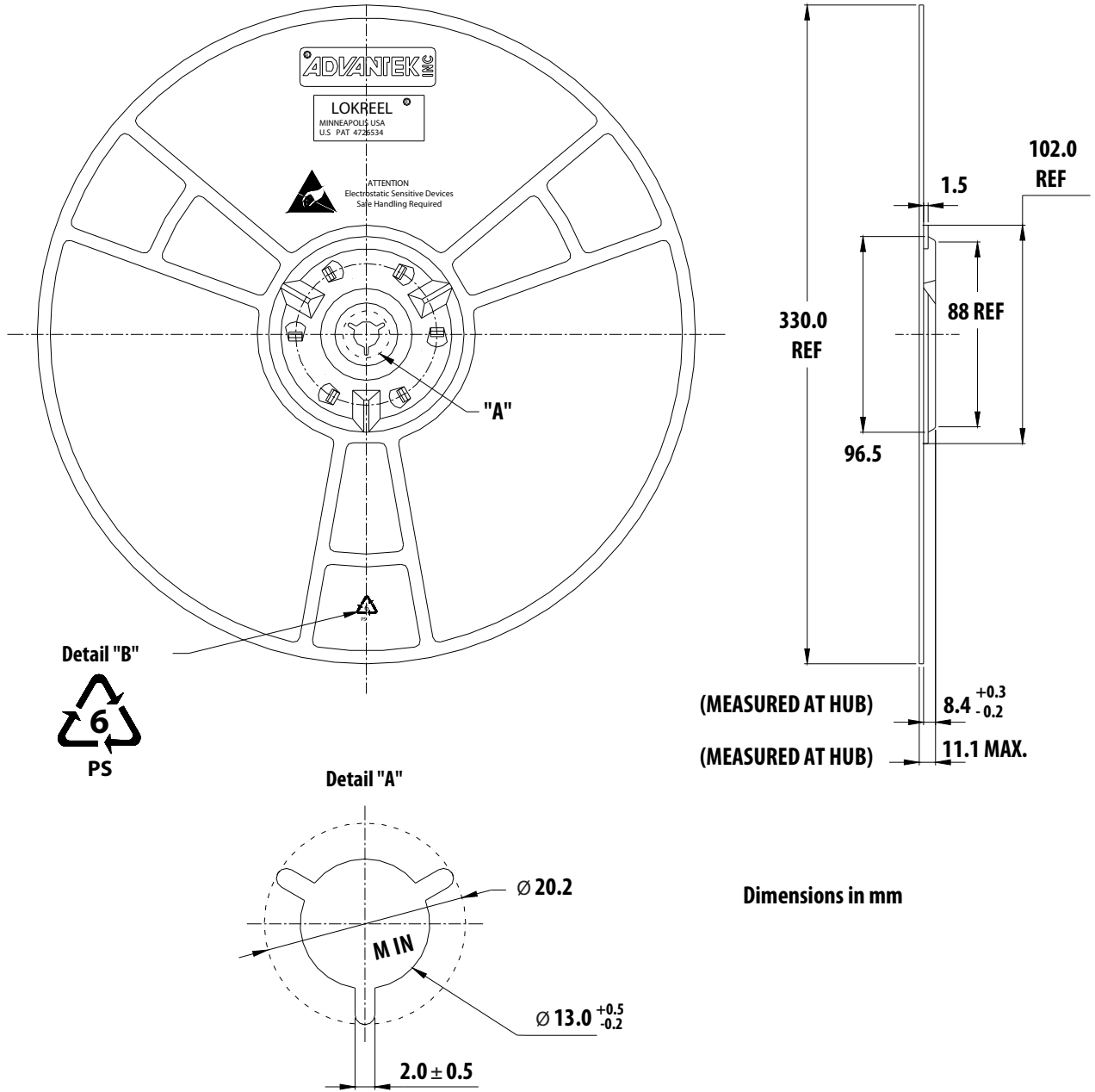

For product information and a complete list of distributors, please go to our web site: [www.avagotech.com](http://www.avagotech.com)

Avago, Avago Technologies, and the A logo are trademarks of Avago Technologies in the United States and other countries. Data subject to change. Copyright © 2005-2013 Avago Technologies. All rights reserved. AV02-2586EN - November 11, 2013

