

# AMMP-6125

## 10-24 GHz x2 Frequency Multiplier

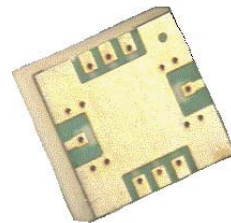

### Data Sheet



#### Description

The AMMP-6125 is an easy-to-use surface mounted packaged integrated frequency multiplier (x2) that operates from 10 to 24 GHz output frequency. It has integrated amplification, matching, harmonic suppression, and bias networks. 15 dBc min. of harmonic rejection is delivered. The input/output are matched to 50 Ω and fully DC blocked. This MMIC is a cost effective alternative to hybrid (discrete-FET) amplifiers that require complex tuning and assembly process.

#### Functional Block Diagram

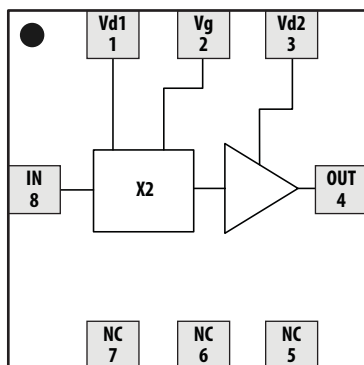

Pin	Function
1	Vd1
2	Vg
3	Vd2
4	RF_OUT
5	NC
6	NC
7	NC
8	RF_IN

#### Features

- 5 x 5 mm surface mount package
- Wide frequency operation: 10-24 GHz (Output)
- 50 Ω Input and Output Match
- -40° C to +85° C operation
- Output Power of +21.5 dBm Typical
- Fo, 3xFo, 4Fo Rejection: 15 dBc min

#### Applications

- Microwave Radio Systems
- VSAT
- Satellite Up/Down Link
- Test Equipment

#### Package Diagram

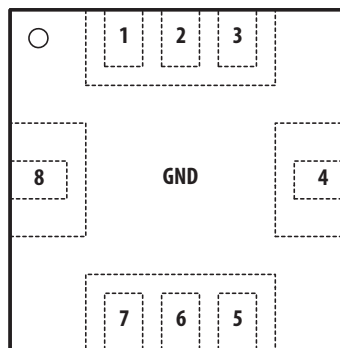

TOP VIEW



**Attention: Observe Precautions for handling electrostatic sensitive devices.**  
 ESD Machine Model: 40V  
 ESD Human Body Model: 150V  
 Refer to Avago Application Note A004R: Electrostatic Discharge Damage and Control.

## ELECTRICAL SPECIFICATIONS

**Table 1. Absolute Maximum Ratings**

Parameter		Specifications			Comments
Description		Min.	Max.	Unit	
Drain Voltage	Vd1		5	V	
	Vd2		6	V	
Gate Voltage	Vg	-2.5	0	V	
CW Input Power			10	dBm	
MSL			MSL2		
Channel Temperature			150	°C	
Storage Temperature		-65	150	°C	

**Table 2. Recommended Operating Range**

Parameter		Specifications				Comments
Description	Pin	Min.	Typical	Max.	Unit	
Drain Voltage	Vd1		3.5	4.0	V	
	Vd2		5.0	5.5	V	
Gate Voltage	Vg	-1.4	-1.2	-1	V	
Frequency range	Input	5		12	GHz	
	Output	10		24	GHz	
Input Power		-6	0	+4	dBm	
Quiescent Current	I <sub>dsq1</sub>		100		mA	Vd1 = 3.5 V
	I <sub>dsq2</sub>		110		mA	Vd2 = 5 V
Thermal Resistance, $\theta_{ch-b}$			26.4		°C/W	
Case Temperature		-40		+85	°C	
ESD	Human Body Model		150		V	
	Machine Model		40		V	

**Table 3. RF Electrical Characteristics**

All data measured on a Rogers 4003 demo board at  $V_{d1} = 3.5\text{ V}$ ,  $V_{d2} = 5\text{ V}$ ,  $V_g = -1.2\text{ V}$ ,  $T_A = 25^\circ\text{C}$ ,  $P_{in} = 0\text{ dBm}$  and  $50\ \Omega$  at all ports, unless otherwise specified.

Parameter		Performance			Unit	Comments
		Min.	Typical	Max.		
Output Power	Freq = 10 GHz	20	22.8		dBm	
	Freq = 17 GHz		22.1			
	Freq = 24 GHz		21.5			
Fundamental Suppression	Freq = 5 GHz	15	21		dBc	$f_{in} = 5, 8.5, 12\text{ GHz}$
	Freq = 8.5 GHz		25.9			
	Freq = 12 GHz		29.5			
3 <sup>rd</sup> Harmonic Suppression	Freq = 15 GHz	15	18.3		dBc	$f_{in} = 5, 8.5, 12\text{ GHz}$
	Freq = 25.5 GHz		27.2			
	Freq = 36 GHz		25.2			
4 <sup>th</sup> Harmonic Suppression			15		dBc	
Input Return Loss			-12		dB	
Output Return Loss			-10		dB	
Drain Current	$I_{d1}$		115		mA	$P_{out} = 21\text{ dBm}$
	$I_{d2}$		145		mA	
Gate Current ( $I_g$ )			-5		$\mu\text{A}$	

Note:

- Output Power, Fundamental Suppression and 3<sup>rd</sup> Harmonic Suppression measurement accuracy is subjected to the tolerance of  $\pm 0.5\text{ dBm}$ ,  $\pm 1\text{ dBc}$  &  $\pm 1\text{ dBc}$  respectively.

**Product Consistency Distribution Charts at 5 GHz, 8.5 GHz and 12 GHz,  
 $V_{d1} = 3.5\text{ V}$ ,  $V_{d2} = 5\text{ V}$ ,  $V_g = -1.2\text{ V}$  (Sample size of 2,800 pieces)**

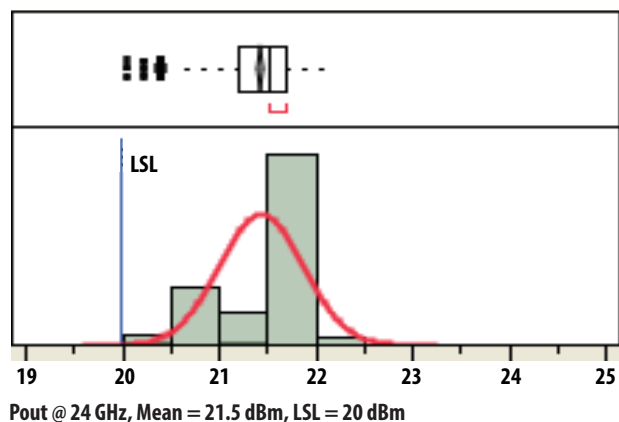
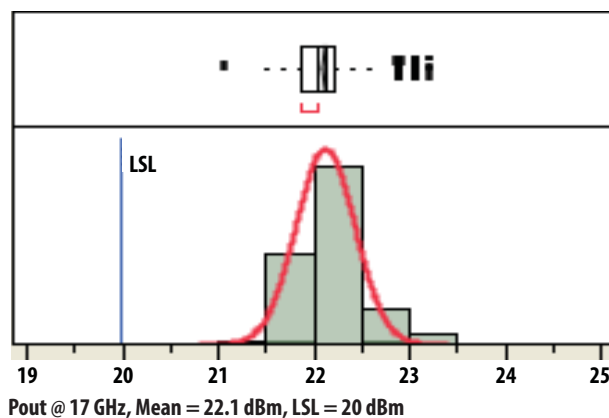
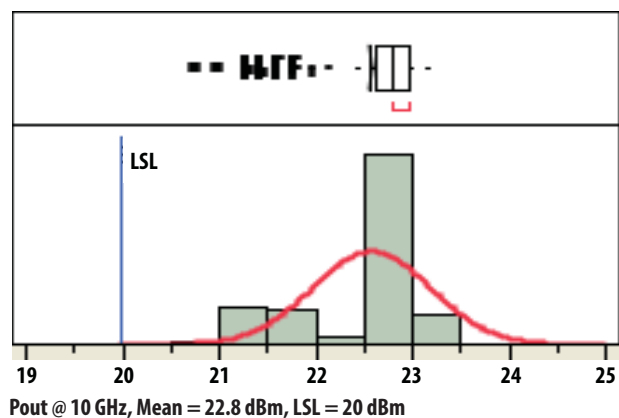

**Product Consistency Distribution Charts at 5 GHz, 8.5 GHz and 12 GHz,  
Vd1 = 3.5 V, Vd2 = 5 V, Vg = -1.2 V (Sample size of 2,800 pieces) (Continued)**

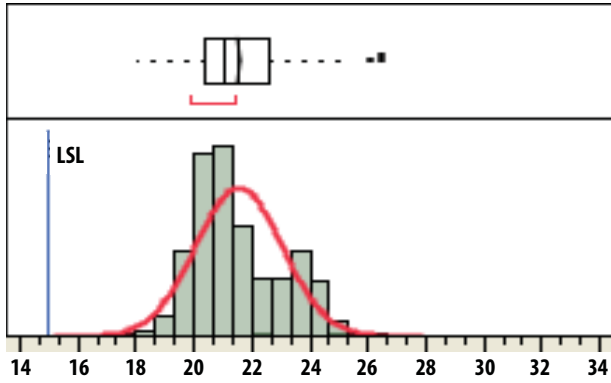

FS @ 5 GHz, Mean = 21 dBc, LSL = 15 dBc

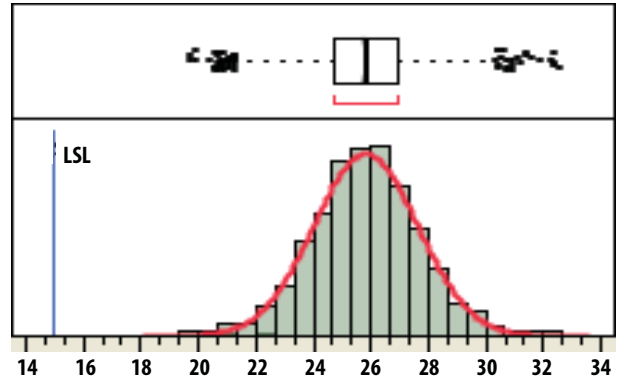

FS @ 8.5 GHz, Mean = 25.9 dBc, LSL = 15 dBc

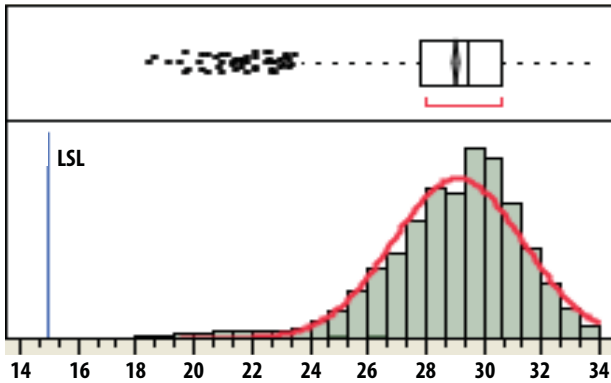

FS @ 12 GHz, Mean = 29.5 dBc, LSL = 15 dBc

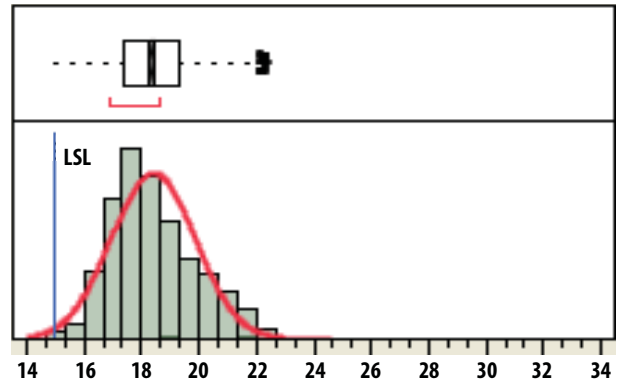

Harmonics @ 15 GHz, Mean = 18.3 dBc, LSL = 15 dBc

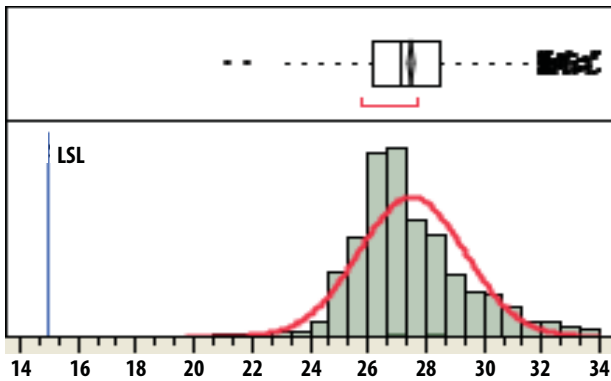

Harmonics @ 25.5 GHz, Mean = 27.2 dBc, LSL = 15 dBc

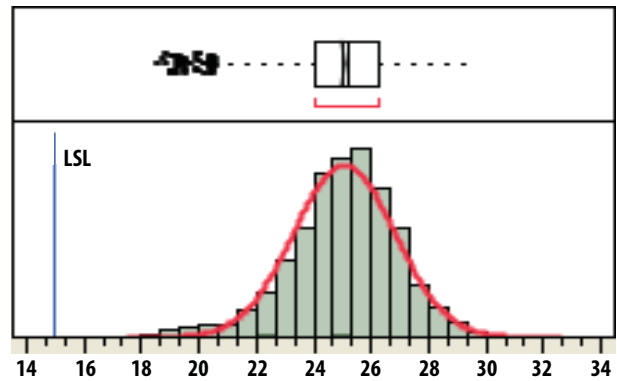

Harmonics @ 36 GHz, Mean = 25.2 dBc, LSL = 15 dBc

## Selected Performance Plots

All data measured on a Rogers 4003 demo board at  $V_{d1} = 3.5\text{ V}$ ,  $V_{d2} = 5\text{ V}$ ,  $V_g = -1.2\text{ V}$ ,  $T_A = 25^\circ\text{ C}$ ,  $P_{in} = 0\text{ dBm}$  and  $50\ \Omega$  at all ports, unless otherwise specified.

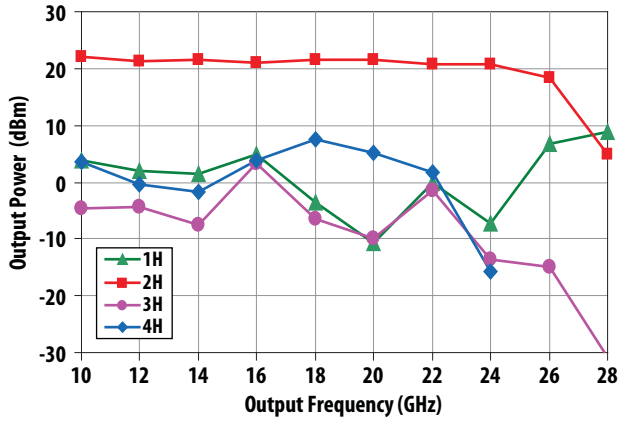

Figure 1. Output Power vs. Output Frequency @  $P_{in} = 0\text{ dBm}$

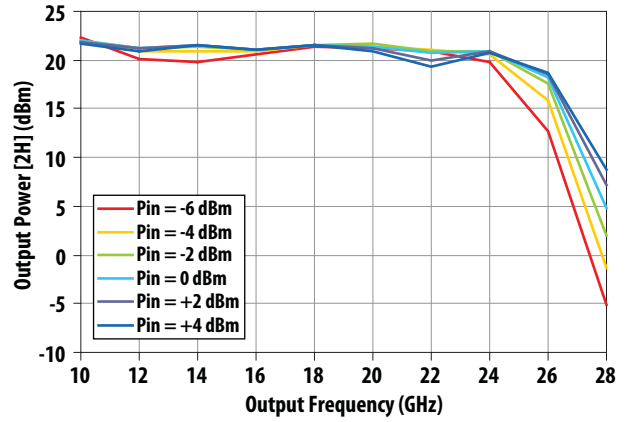

Figure 2. Output Power [2H] vs Output Frequency Over Pin

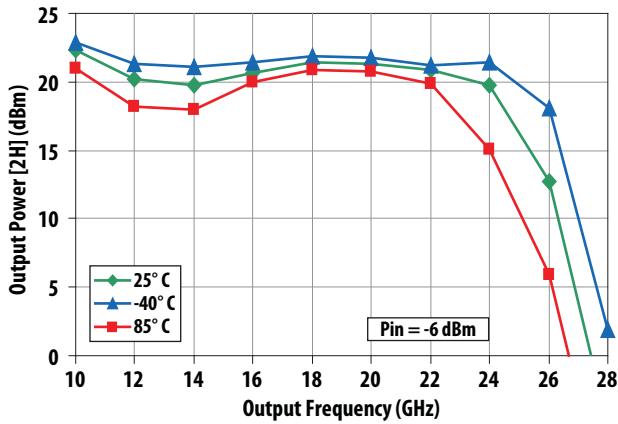

Figure 3. Output Power vs. Output Frequency @  $P_{in} = -6\text{ dBm}$  over Temperature

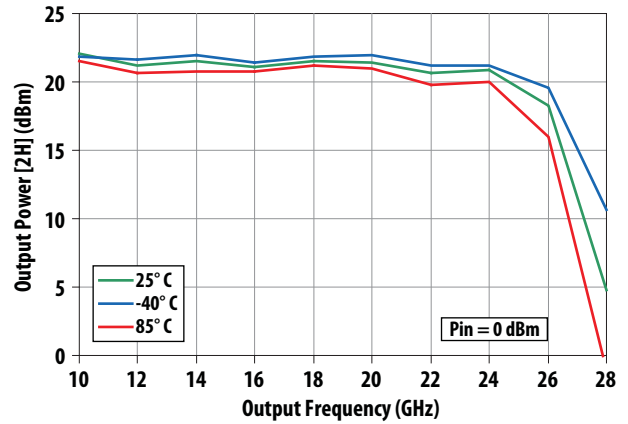

Figure 4. Output Power vs. Output Frequency @  $P_{in} = 0\text{ dBm}$  over Temperature

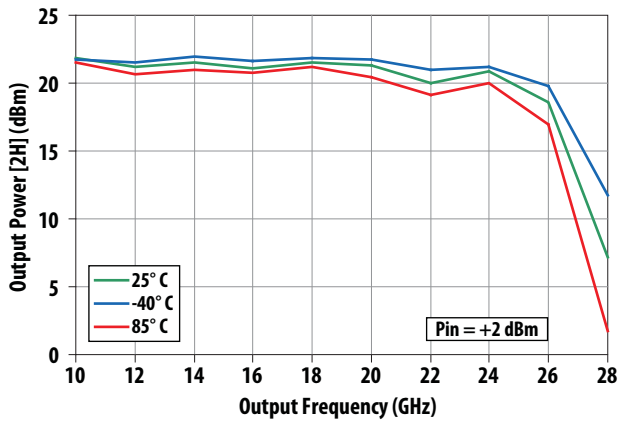

Figure 5. Output Power vs. Output Frequency @  $P_{in} = +2\text{ dBm}$  over Temperature

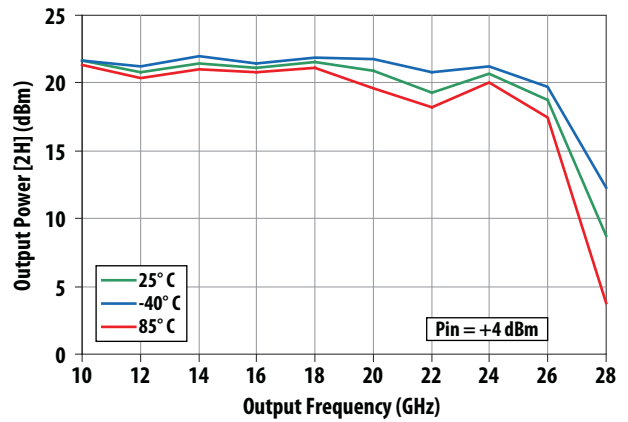

Figure 6. Output Power vs. Output Frequency @  $P_{in} = +4\text{ dBm}$  over Temperature

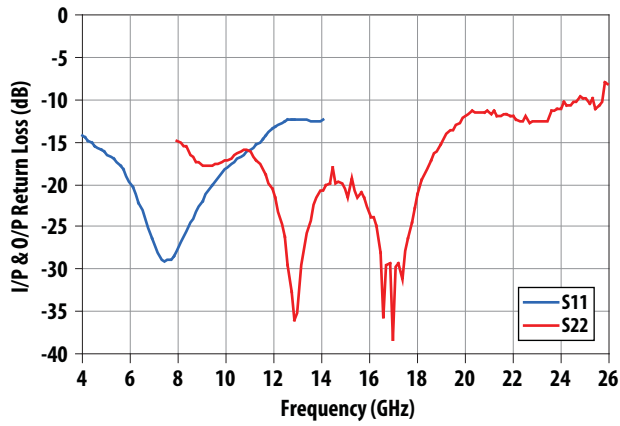

Figure 7. Input and Output Return Loss at Pin = 0 dBm

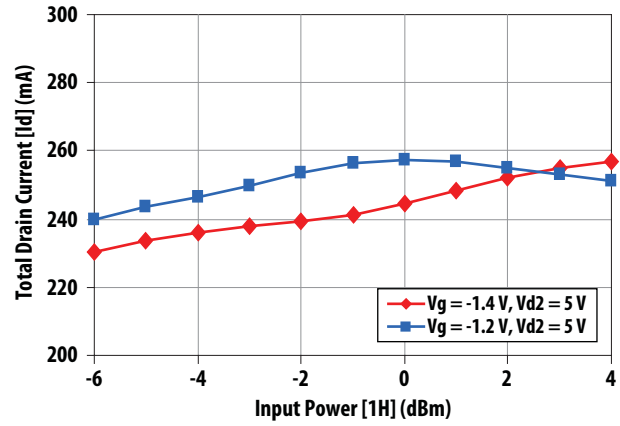

Figure 8. Total Drain Current vs. Pin

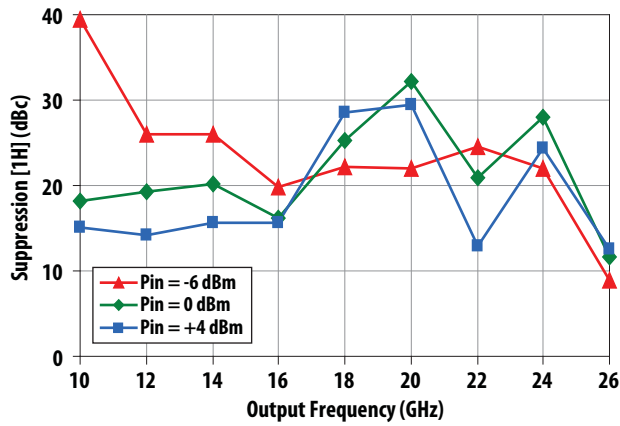

Figure 9. Fundamental [1H] Suppression vs Output Frequency at Variable Pin

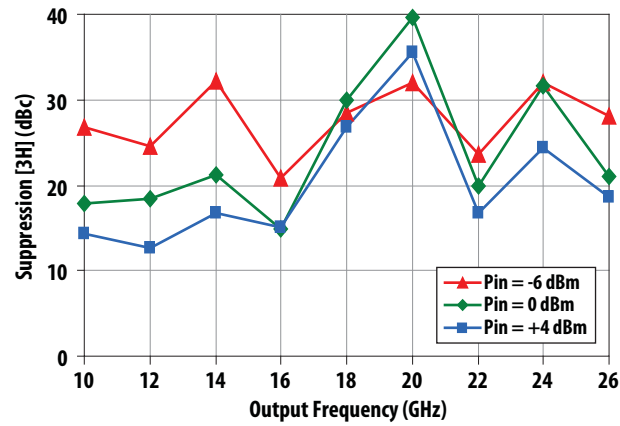

Figure 10. 3<sup>rd</sup> Harmonic [3H] Suppression vs Output Frequency at Variable Pin

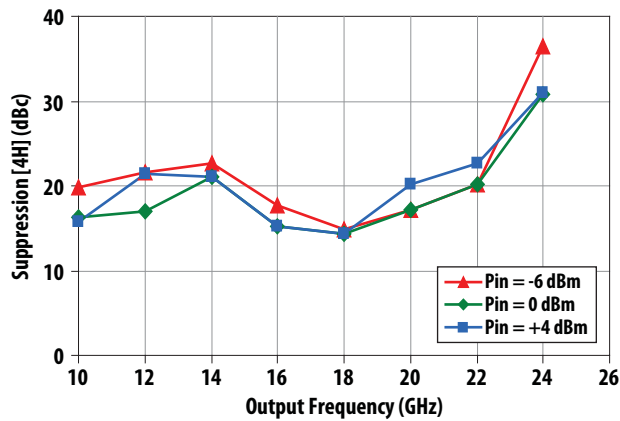

Figure 11. 4<sup>th</sup> Harmonic [4H] Suppression vs Output Frequency at Variable Pin

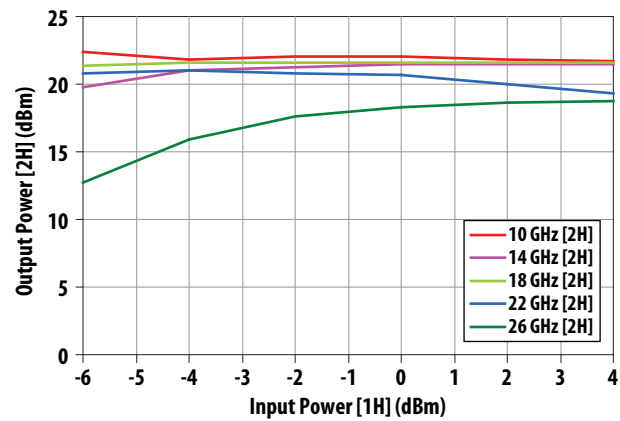

Figure 12. Output Power [2H] vs Pin at variable Output Frequency

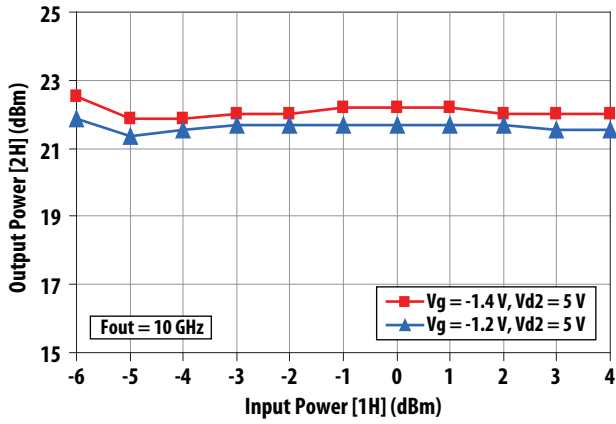

Figure 13. Output Power [2H] vs Input Power @ Fout = 10 GHz

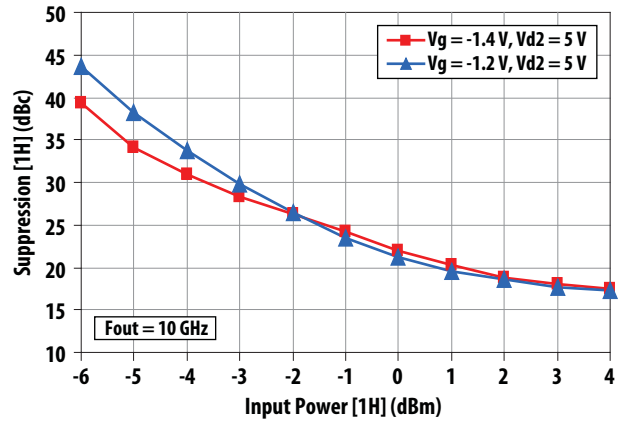

Figure 14. Fundamental Suppression [1H] vs Input Power @ Fout = 10 GHz

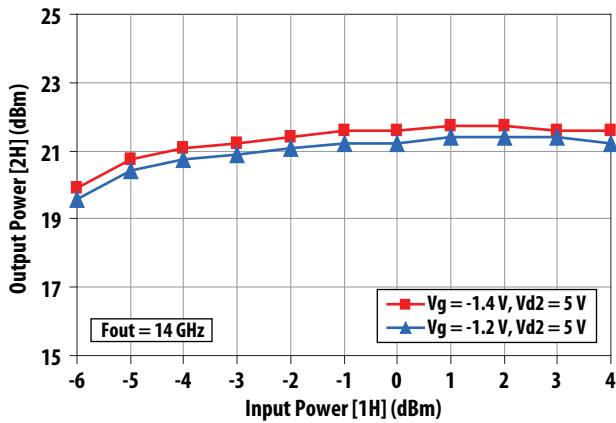

Figure 15. Output Power [2H] vs Input Power @ Fout = 14 GHz

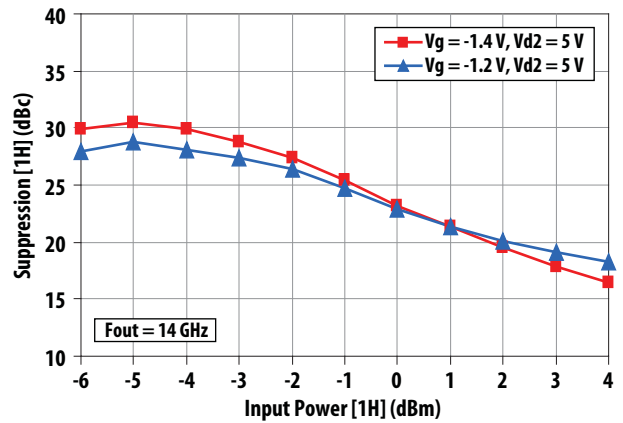

Figure 16. Fundamental Suppression [1H] vs Input Power @ Fout = 14 GHz

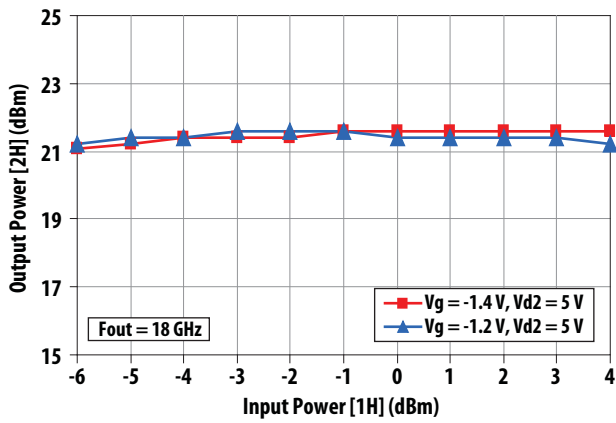

Figure 17. Output Power [2H] vs Input Power @ Fout = 18 GHz

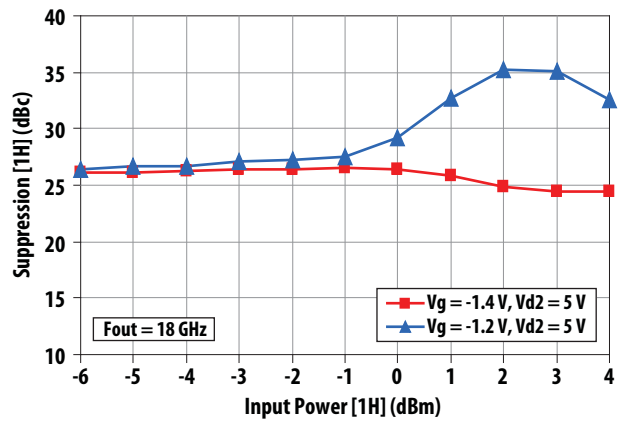

Figure 18. Fundamental Suppression [1H] vs Input Power @ Fout = 18 GHz

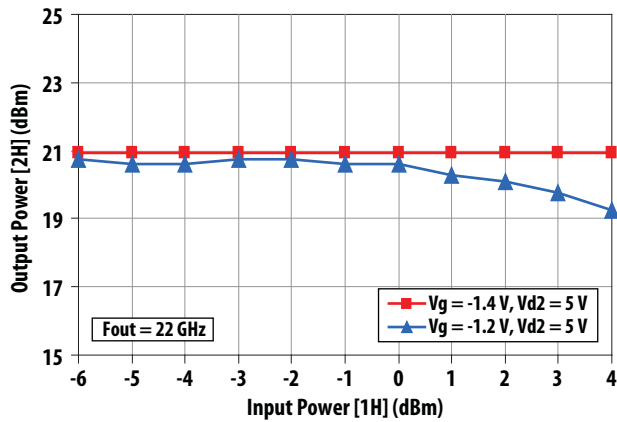

Figure 19. Output Power [2H] vs Input Power @ Fout = 22 GHz

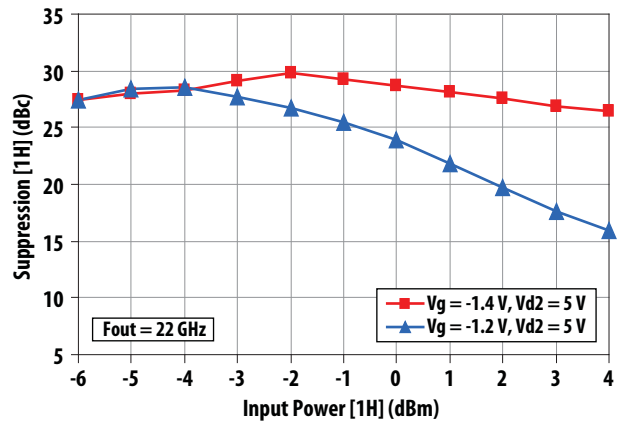

Figure 20. Fundamental Suppression [1H] vs Input Power @ Fout = 22 GHz

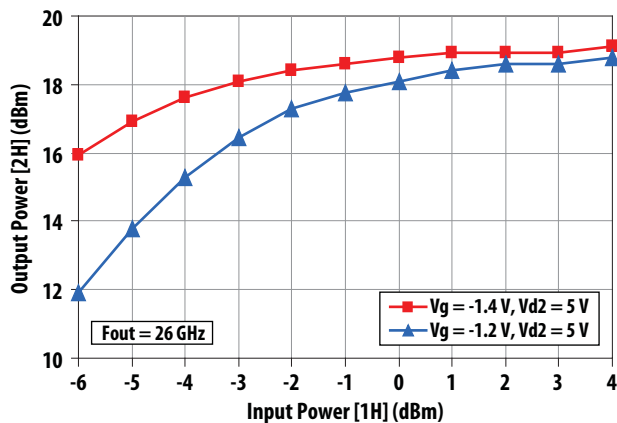

Figure 21. Output Power [2H] vs Input Power @ Fout = 26 GHz

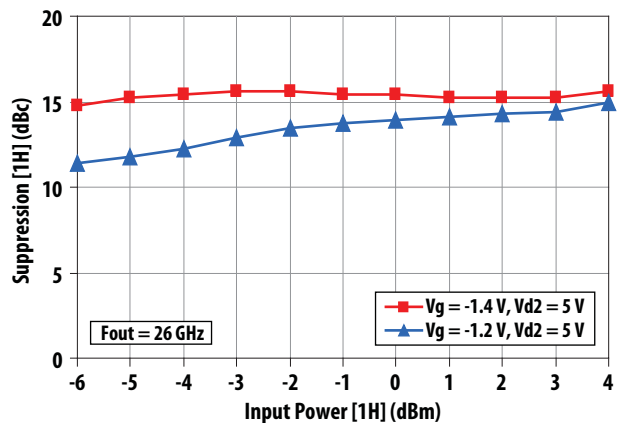

Figure 22. Fundamental Suppression [1H] vs Input Power @ Fout = 26 GHz

## Evaluation Board Description and Application Circuit for AMMP-6125

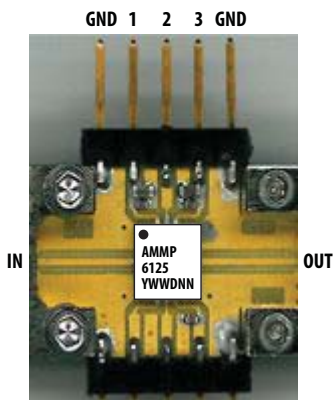
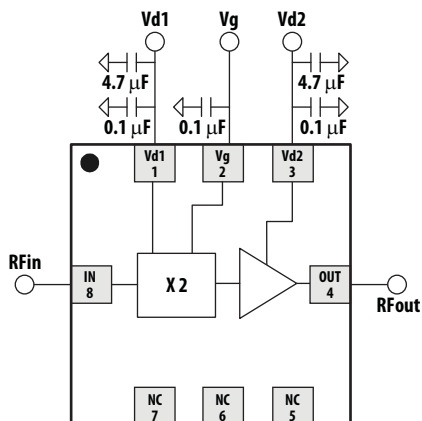

Table 4. Pin Description

Pin #	Function	Biasing	Comment
GND	GND		
1	Vd1	3.5 V	100 mA (measure current)
2	Vg	-1.2 V	5 $\mu$ A (measure current)
3	Vd2	5.0 V	110 mA (measure current)
GND	GND		



Recommended quiescent DC bias condition for optimum power and linearity performance is  $V_{d1} = 3.5$  V,  $V_{d2} = 5$  V and  $V_g = -1.2$  V. The gate voltage,  $V_g$ , biases the doubling circuit only; it does not adjust the amplifier bias current. Minor improvements in the AMMP-6125's output power and fundamental suppression can be obtained by adjusting  $V_g$  from -1.0 V to -1.5 V.



## Package, Tape & Reel, and Ordering Information

Please refer to Avago Technologies Application Note 5521, AMxP-xxxx production Assembly Process (Land Pattern B).

### Part Number Ordering Information

Part Number	Devices per Container	Container
AMMP-6125-BLKG	10	Antistatic bag
AMMP-6125-TR1G	100	7" reel
AMMP-6125-TR2G	500	7" reel

For product information and a complete list of distributors, please go to our web site: [www.avagotech.com](http://www.avagotech.com)

Avago, Avago Technologies, and the A logo are trademarks of Avago Technologies in the United States and other countries.  
Data subject to change. Copyright © 2011-2016 Avago Technologies. All rights reserved.  
AV02-3208EN - March 23, 2016

