

MGA-43628

High Linearity (2.0 – 2.2) GHz Power Amplifier Module



Data Sheet

Description

Avago Technologies' MGA-43628 is a fully matched power amplifier for use in the (2.0-2.2) GHz band. High linear output power at 5 V is achieved through the use of Avago Technologies' proprietary 0.25 μm GaAs Enhancement-mode pHEMT process. MGA-43628 is housed in a miniature 5.0 mm x 5.0 mm molded-chip-on-board (MCOB) module package. A detector is also included on-chip. The compact footprint coupled with high gain, high linearity and good efficiency makes the MGA-43628 an ideal choice as a power amplifier for small cell BTS PA applications.

Applications

- Final stage high linearity amplifier for Picocell and Enterprise Femtocell PA targeted for small cell BTS downlink applications.

Component Image

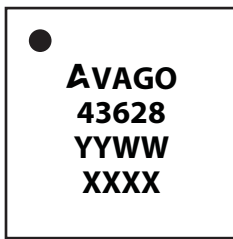

TOP VIEW

5.0 x 5.0 x 0.9 mm Package Outline

Note:
Package marking provides orientation and identification
"43628" = Device part number
"YYWW" = year and work week
"XXXX" = assembly lot number

Pin Configuration

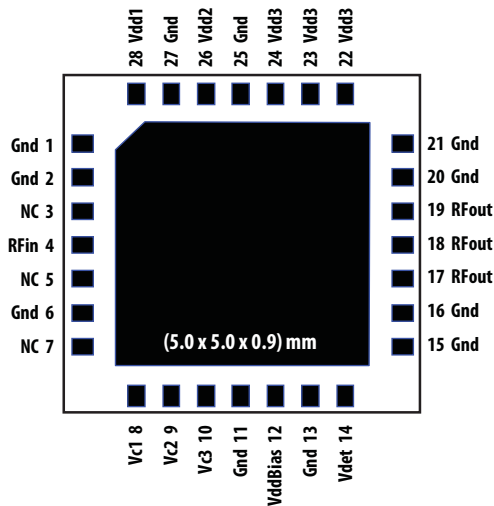

Features

- High linearity performance: Typ -50 dBc ACLR1^[1] at 27.2 dBm linear output power (biased with 5.0 V operating voltage)
- High Gain: 41.5 dB
- Good efficiency
- Fully matched
- Built-in detector
- GaAs E-pHEMT Technology^[2]
- Low cost small package size: 5.0 x 5.0 x 0.9 mm
- MSL3
- Lead free/Halogen free RoHS compliance

Specifications

2.14 GHz; 5.0 V, Idqtotal = 440 mA (typ), W-CDMA Test model #1, 64 DPCH downlink signal

- PAE: 14%
- 27.2 dBm linear Pout @ ACLR1 = -50 dBc^[1]
- 41.5 dB Gain
- Detector range: 20 dB

Note:

- W-CDMA Test model #1, 64DPCH downlink signal.
- Enhancement mode technology employs positive Vgs, thereby eliminating the need of negative gate voltage associated with conventional depletion mode devices.

Functional Block Diagram

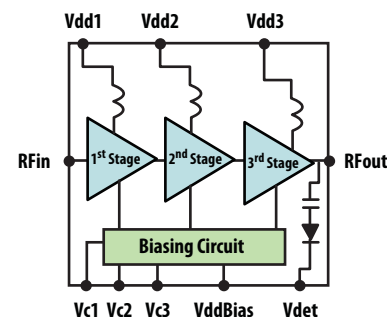

Attention: Observe precautions for handling electrostatic sensitive devices.
ESD Machine Model = 60 V
ESD Human Body Model = 450 V
Refer to Avago Application Note A004R:
Electrostatic Discharge, Damage and Control.

Absolute Maximum Rating^[1] $T_A = 25^\circ\text{C}$

Symbol	Parameter	Units	Absolute Max.
Vdd, VddBias	Supply voltages, bias supply voltage	V	6
Vc	Control Voltage	V	(Vdd)
P _{in,max}	CW RF Input Power	dBm	20
P _{diss}	Total Power Dissipation ^[3]	W	7.2
T _j	Junction Temperature	°C	150
T _{STG}	Storage Temperature	°C	-65 to 150

Thermal Resistance^[2,3]

$\theta_{jC} = 13^\circ\text{C/W}$

Notes:

1. Operation of this device in excess of any of these limits may cause permanent damage.
2. Thermal resistance measured using Infra-Red Measurement Technique at Vdd = 5.5 V operating voltage.
3. Board temperature (TB) is 25° C, for TB > 56.4° C derate the device power at 77 mW per °C rise in Board (package belly) temperature.

Electrical Specifications

$T_A = 25^\circ\text{C}$, Vdd = VddBias = 5.0 V, Vc1=2.4V, Vc2=1.6V, Vc3=2.2V, Idqtotal = 440 mA, RF performance at 2.14 GHz, W-CDMA Test model #1, 64DPCH downlink signal operation unless otherwise stated.

Symbol	Parameter and Test Condition	Units	Min.	Typ.	Max.
Vdd	Supply Voltage	V		5.0	
Idqtotal	Quiescent Supply Current	mA		440	600
Gain	Gain	dB	38	41.5	
OP1dB	Output Power at 1dB Gain Compression	dBm		36.8	
ACLR1 @ Pout = 27.2 dBm	W-CDMA Test model #1, 64DPCH downlink signal	dBc		-50	
PAE @ Pout = 27.2 dBm	Power Added Efficiency	%	11.5	14	
S11	Input Return Loss, 50 Ω source	dB		15.8	
DetR	Detector RF dynamic range	dB		20	

$T_A = 25^\circ\text{C}$, Vdd = VddBias = 5.5 V, Vc1=2.4V, Vc2=1.6V, Vc3=2.2V, Idqtotal = 490 mA, RF performance at 2.14 GHz, W-CDMA Test model #1, 64DPCH downlink signal operation unless otherwise stated.

Symbol	Parameter and Test Condition	Units	Typ.
Vdd	Supply Voltage	V	5.5
Idqtotal	Quiescent Supply Current	mA	490
Gain	Gain	dB	41.5
OP1dB	Output Power at 1dB Gain Compression	dBm	37.6
ACLR1 @ Pout = 27.9 dBm	W-CDMA Test model #1, 64DPCH downlink signal	dBc	-50
PAE @ Pout = 27.9 dBm	Power Added Efficiency	%	13.2
S11	Input Return Loss, 50 Ω source	dB	16.1
DetR	Detector RF dynamic range	dB	20

Product Consistency Distribution Charts [4]

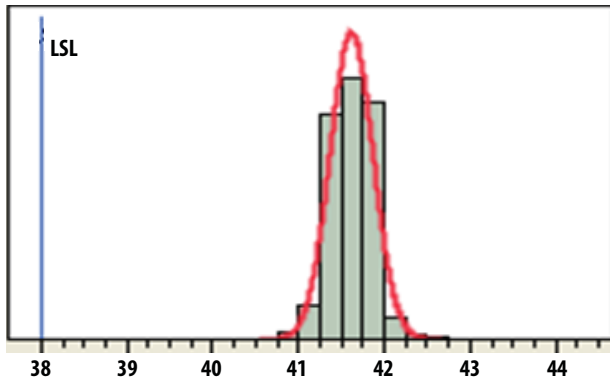

Figure 1. Gain at Pout=27.2dBm; LSL=38dB, Nominal = 41.5dB

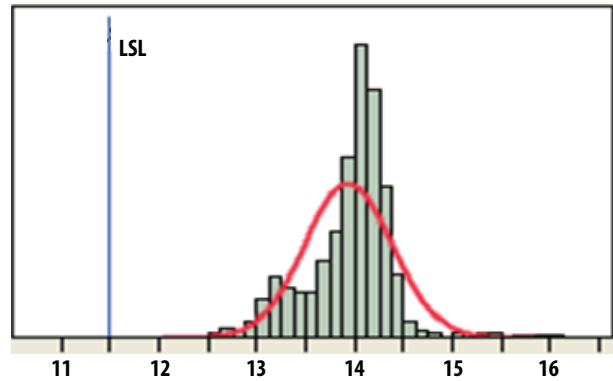

Figure 2. PAE at Pout=27.2dBm; LSL=11.5%, Nominal = 14%

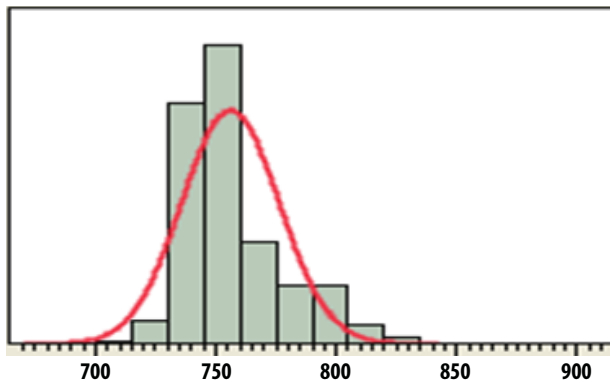

Figure 3. Idd_Total at Pout = 27.2 dBm, Nominal = 750 mA

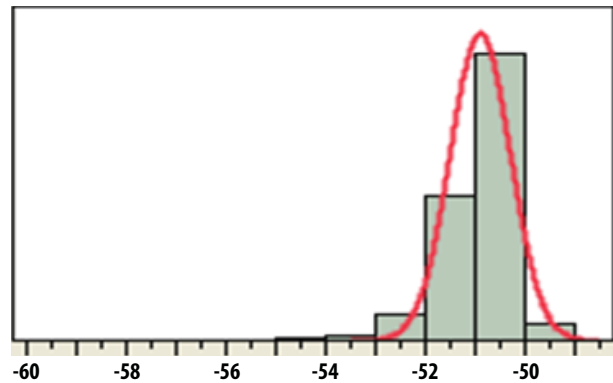

Figure 4. ACLR1 at Pout = 27.2 dBm, Nominal = -50.8 dBc

Note:

- Distribution data sample size is 1500 samples taken from 3 different wafer lots. $T_A = 25^\circ\text{C}$, $V_{dd} = V_{ddBias} = 5.0\text{V}$, $V_{c1} = 2.4\text{V}$, $V_{c2} = 1.6\text{V}$, $V_{c3} = 2.2\text{V}$, RF performance at 2.14 GHz unless otherwise stated. Future wafers allocated to this product may have nominal values anywhere between the upper and lower limits.

MGA-43628 typical over-temperature performance at $V_{c1} = 2.4\text{ V}$, $V_{c2} = 1.6\text{ V}$, $V_{c3} = 2.2\text{ V}$ as shown in Figure 30 unless otherwise stated

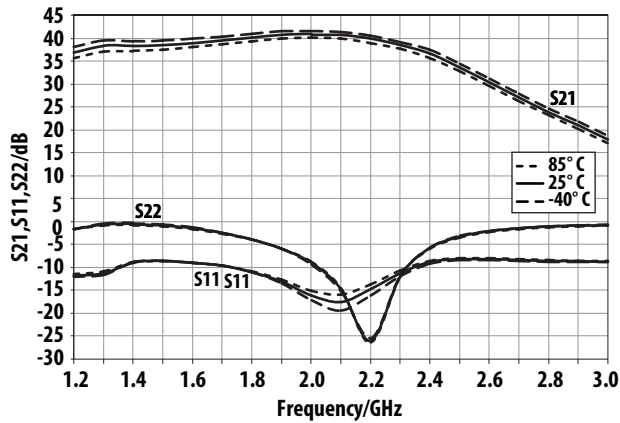

Figure 5. Small-signal performance Over-temperature
 $V_{dd} = V_{ddBias} = 5.0\text{ V}$ operating voltage

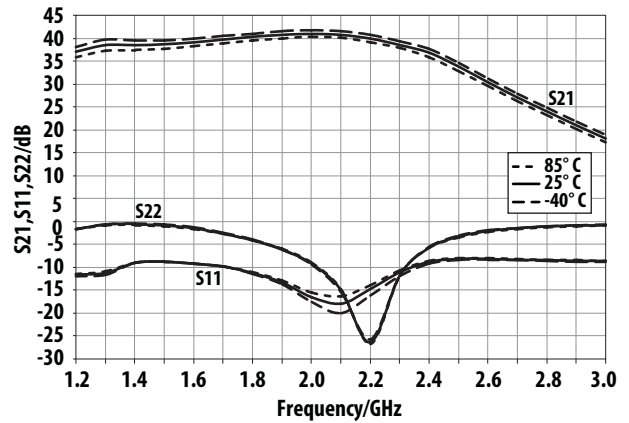

Figure 6. Small-signal performance Over-temperature
 $V_{dd} = V_{ddBias} = 5.5\text{ V}$ operating voltage

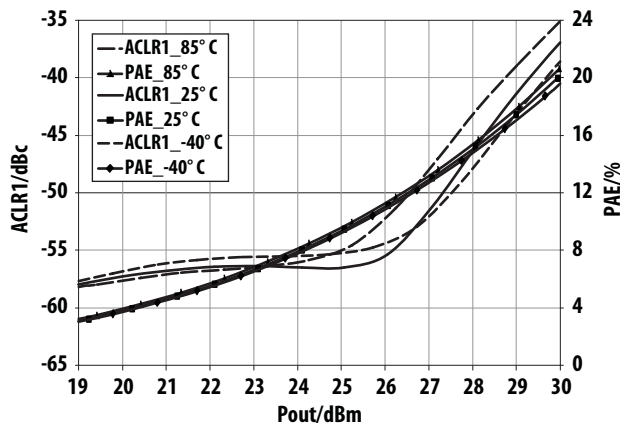

Figure 7. Over-temperature ACLR1, PAE vs Pout @ 2.11 GHz
 $V_{dd} = V_{ddBias} = 5.0\text{ V}$ operating voltage

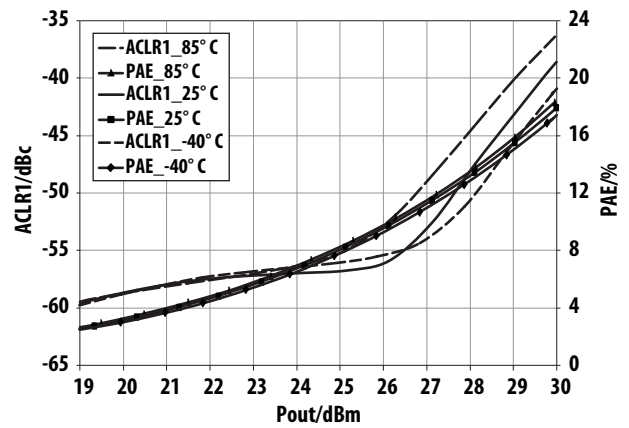

Figure 8. Over-temperature ACLR1, PAE vs Pout @ 2.11 GHz
 $V_{dd} = V_{ddBias} = 5.5\text{ V}$ operating voltage

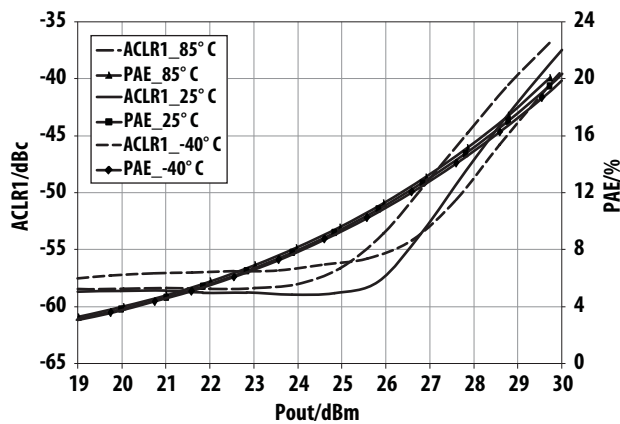

Figure 9. Over-temperature ACLR1, PAE vs Pout @ 2.14 GHz
 $V_{dd} = V_{ddBias} = 5.0\text{ V}$ operating voltage

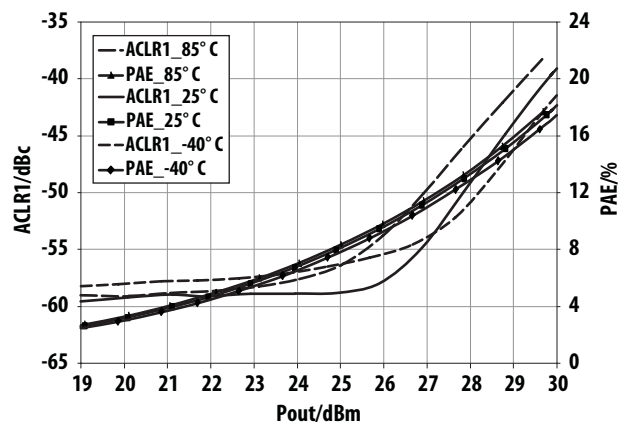
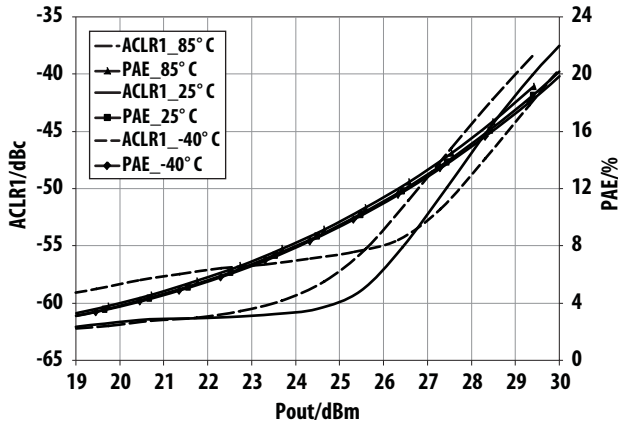
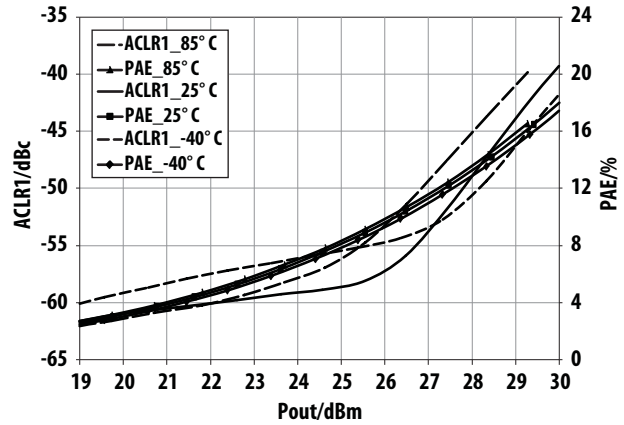

Figure 10. Over-temperature ACLR1, PAE vs Pout @ 2.14 GHz
 $V_{dd} = V_{ddBias} = 5.5\text{ V}$ operating voltage

MGA-43628 typical over-temperature performance at $V_{c1} = 2.4\text{ V}$, $V_{c2} = 1.6\text{ V}$, $V_{c3} = 2.2\text{ V}$ unless otherwise stated



**Figure 11. Over-temperature ACLR1, PAE vs Pout @ 2.17 GHz
Vdd = VddBias = 5.0 V operating voltage**



**Figure 12. Over-temperature ACLR1, PAE vs Pout @ 2.17 GHz
Vdd = VddBias = 5.5 V operating voltage**

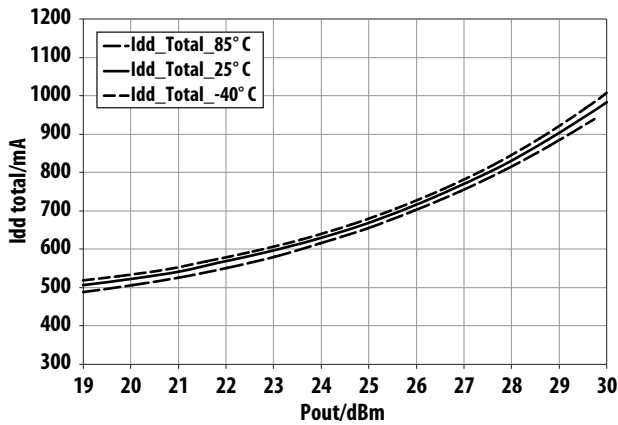

**Figure 13. Over-temperature Idd_Total vs Pout @ 2.14 GHz
Vdd = VddBias = 5.0 V operating voltage**

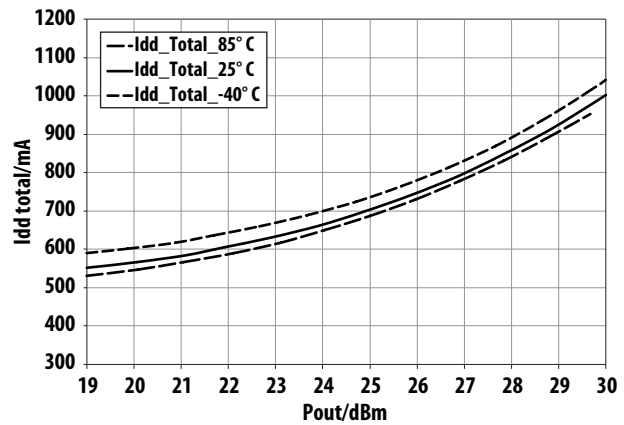

**Figure 14. Over-temperature Idd_Total vs Pout @ 2.14 GHz
Vdd = VddBias = 5.5 V operating voltage**

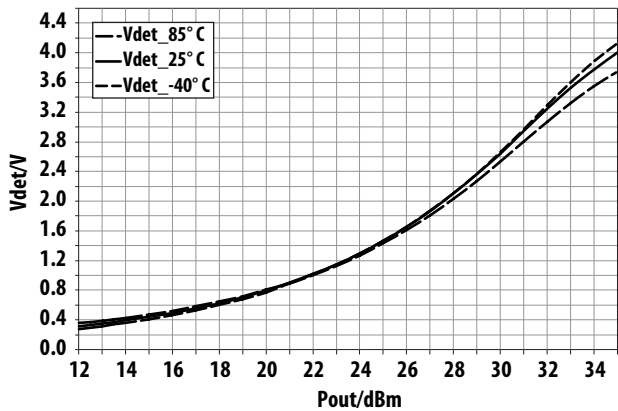

**Figure 15. Over-temperature Vdet vs Pout @ 2.14 GHz
Vdd = VddBias = 5.0 V operating voltage**

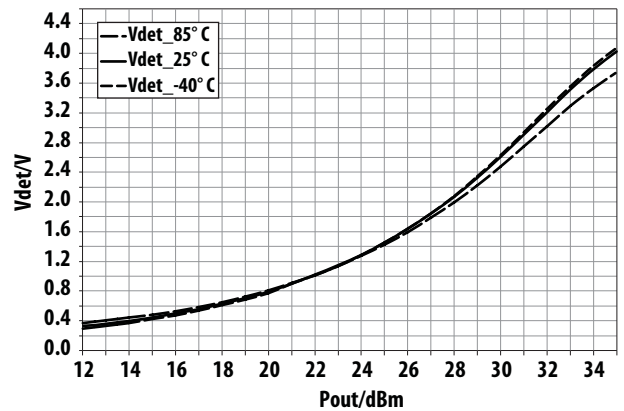

**Figure 16. Over-temperature Vdet vs Pout @ 2.14 GHz
Vdd = VddBias = 5.5 V operating voltage**

MGA-43628 typical over-temperature performance at $V_{c1} = 2.4\text{ V}$, $V_{c2} = 1.6\text{ V}$, $V_{c3} = 2.2\text{ V}$ unless otherwise stated

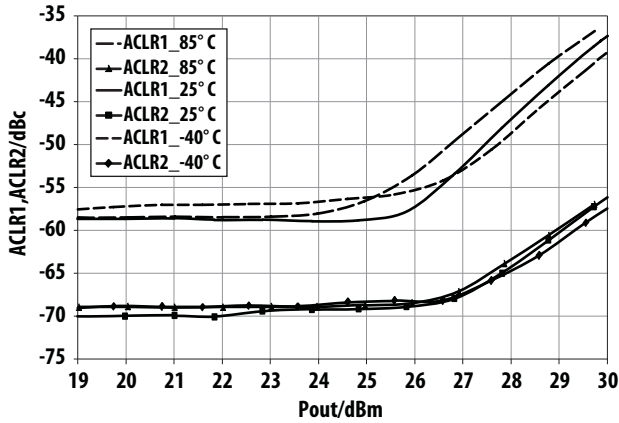

Figure 17. Over-temperature ACLR1, ACLR2 Pout @ 2.14 GHz
Vdd = VddBias = 5.0 V operating voltage

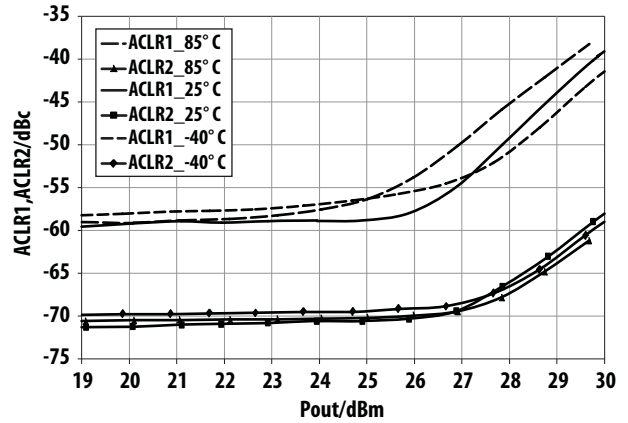

Figure 18. Over-temperature ACLR1, ACLR2 vs Pout @ 2.14 GHz
Vdd = VddBias = 5.5 V operating voltage

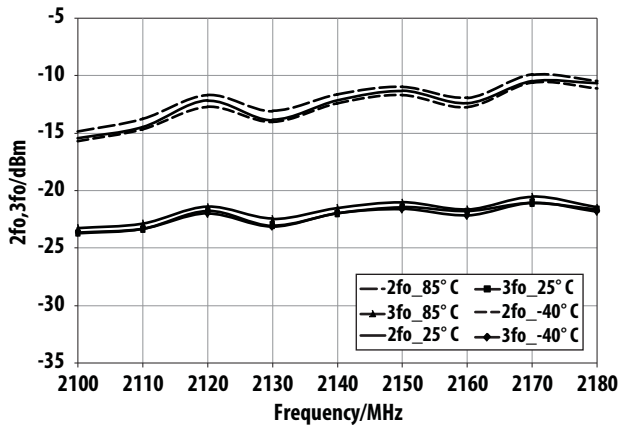

Figure 19. Over-temperature 2nd, 3rd Harmonics vs Freq at Pout = 27.2 dBm,
Vdd = VddBias = 5.0 V operating voltage

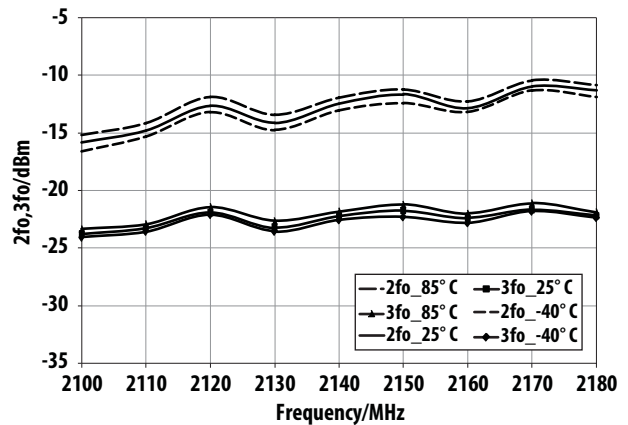

Figure 20. Over-temperature 2nd, 3rd Harmonics vs Freq at Pout = 27.2 dBm,
Vdd = VddBias = 5.5 V operating voltage

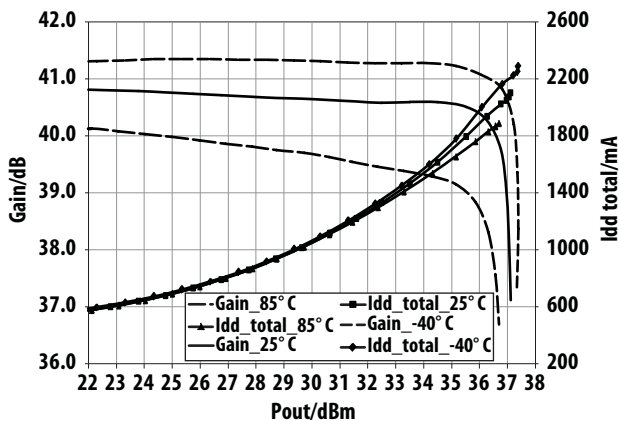

Figure 21. Over-temperature Gain, Idd_total vs Pout @ 2.14 GHz
Vdd = VddBias = 5.0 V operating voltage

MGA-43628 typical over-temperature performance at Vc1 = 2.4 V, Vc2 = 1.6 V, Vc3 = 2.2 V unless otherwise stated

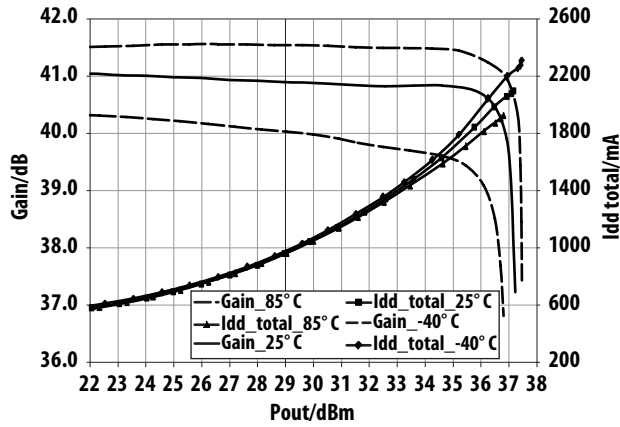

Figure 22. Over-temperature Gain, Idd_total vs Pout @ 2.11 GHz
Vdd = VddBias = 5.0 V operating voltage

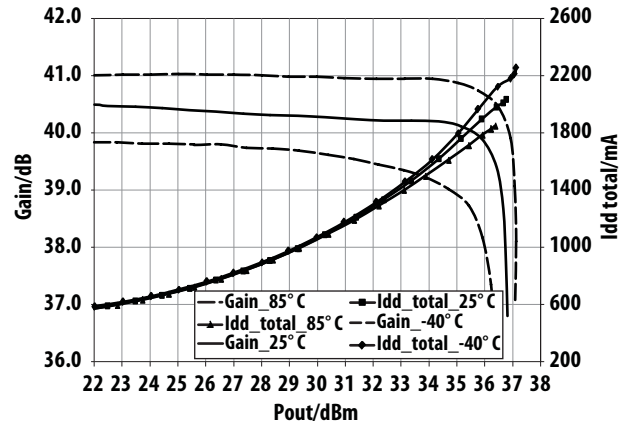

Figure 23. Over-temperature Gain, Idd_total vs Pout @ 2.17 GHz
Vdd = VddBias = 5.0 V operating voltage

MGA-43628 typical 3GPP W-CDMA Test model #1 Spectrum Emission Mask performance at Vdd = VddBias = 5.0 V, Vc1 = 2.4 V, Vc2 = 1.6 V, Vc3 = 2.2 V unless otherwise stated

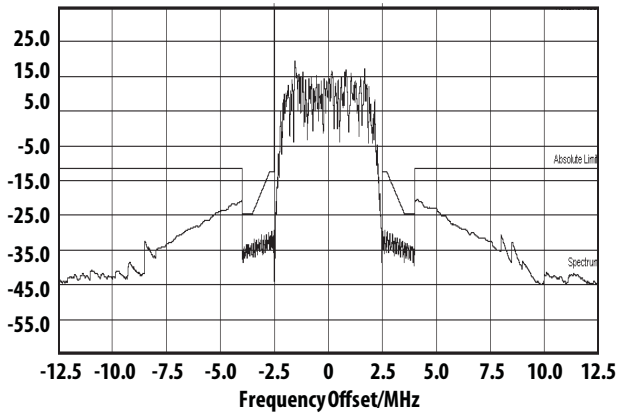

Figure 24. SEM at Pout = 28 dBm @ 2.11 GHz

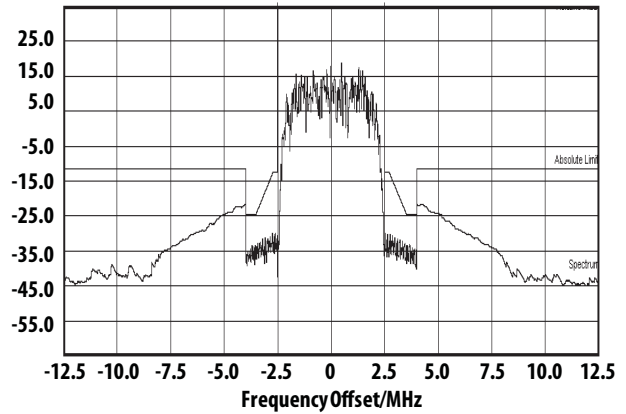

Figure 25. SEM at Pout = 28 dBm @ 2.14 GHz

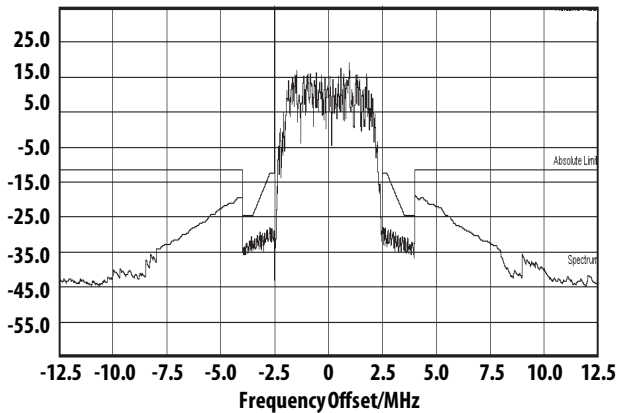

Figure 26. SEM at Pout = 28 dBm @ 2.17 GHz

MGA-43628 typical LTE Downlink (E-TM1.1) 10 MHz 50RB performance at Vdd = VddBias = 5.0 V, Vc1 = 2.2 V, Vc2 = 1.6 V, Vc3 = 2.0 V unless otherwise stated

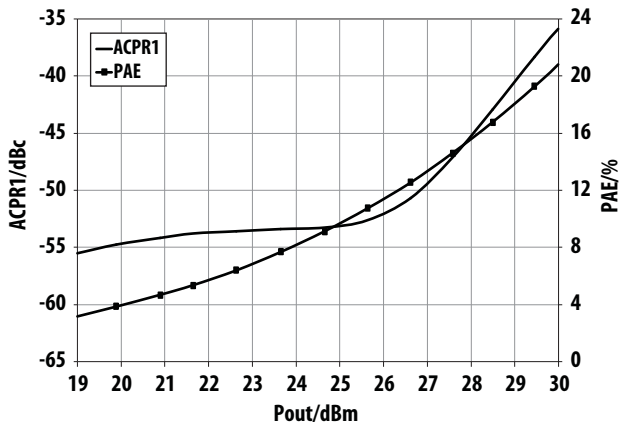

Figure 27. ACPR1, PAE vs Pout @ 2.11 GHz

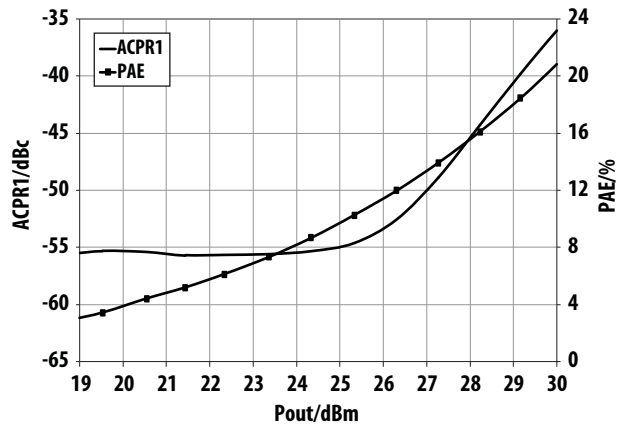

Figure 28. ACPR1, PAE vs Pout @ 2.14 GHz

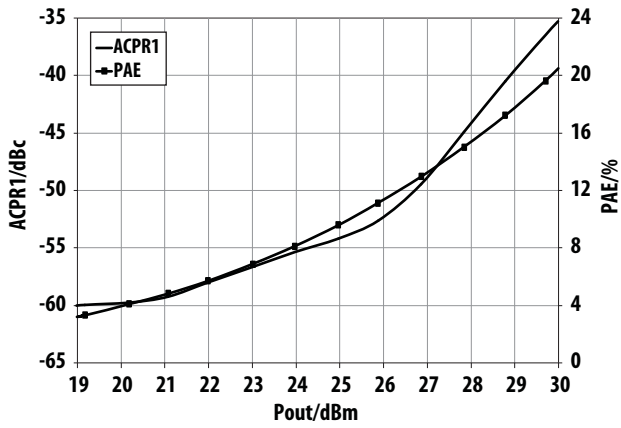

Figure 29. ACPR1, PAE vs Pout @ 2.17 GHz

S-Parameter^[5] (Vdd = VddBias = 5.0 V, Vc1 = 2.4 V, Vc2 = 1.6 V, Vc3 = 2.2 V, TA = 25° C, 50ohm)

Freq (GHz)	S11 (dB)	S11 (ang)	S21 (dB)	S21 (ang)	S12 (dB)	S12 (ang)	S22 (dB)	S22 (ang)
0.1	-0.30	175.06	-57.18	-39.10	-61.12	-112.05	-0.58	175.26
0.2	-0.35	164.36	-52.55	-85.61	-60.63	41.83	-0.92	173.40
0.3	-0.38	154.98	-43.76	-73.69	-63.55	2.56	-1.12	172.26
0.4	-0.37	145.35	-28.46	-63.76	-66.27	12.15	-1.23	171.46
0.5	-0.95	135.17	-14.76	-162.07	-64.90	-2.49	-1.26	171.49
0.6	-0.71	125.36	-15.52	-98.77	-64.53	9.15	-0.98	167.57
0.7	-0.71	110.04	3.08	-114.53	-63.24	122.31	-1.43	165.91
0.8	-2.40	80.38	18.79	33.00	-64.55	105.07	-1.65	165.48
0.9	-5.66	100.45	21.40	65.15	-63.61	117.52	-1.87	165.69
1.0	-3.66	83.17	12.70	19.21	-65.73	73.37	-1.60	167.15
1.1	-3.96	48.86	23.94	84.77	-65.29	57.70	-2.60	166.85
1.2	-15.39	24.98	34.54	26.80	-62.86	83.98	-1.00	166.58
1.3	-10.88	62.04	36.69	-45.42	-64.73	78.44	-0.50	161.28
1.4	-9.98	35.77	37.12	-92.22	-63.37	84.70	-0.44	155.07
1.5	-10.60	6.13	37.64	-129.25	-61.88	85.23	-0.65	148.97
1.6	-11.17	-26.64	38.37	-162.53	-61.45	89.51	-1.08	142.44
1.7	-11.06	-63.12	39.17	164.66	-58.50	93.36	-1.92	136.10
1.8	-10.93	-95.47	40.04	131.88	-56.84	93.39	-3.06	129.46
1.9	-11.16	-123.23	40.80	96.99	-54.06	67.27	-4.93	122.82
2.0	-13.07	-140.18	41.05	60.01	-53.63	53.98	-7.77	118.32
2.1	-15.03	-131.53	40.67	21.57	-52.49	38.60	-12.94	117.59
2.2	-11.88	-115.12	39.82	-11.45	-53.38	22.51	-22.70	-83.11
2.3	-8.23	-127.01	38.74	-52.24	-51.99	4.48	-8.54	-123.11
2.4	-6.74	-145.02	36.01	-89.38	-54.52	-15.90	-4.13	-138.34
2.5	-6.53	-159.78	32.66	-118.56	-57.12	-30.73	-2.27	-150.84
2.6	-6.71	-170.51	29.37	-141.53	-57.17	-23.86	-1.39	-160.05
2.7	-7.10	-106.47	26.22	-161.19	-60.58	-29.76	-0.93	-166.90
2.8	-7.53	175.59	23.23	-178.10	-60.20	-33.50	-0.67	-172.14
2.9	-7.87	171.12	20.39	166.93	-63.97	-48.10	-0.50	-176.37
3.0	-8.18	167.41	17.69	153.18	-63.52	-47.65	-0.39	-35.98
3.1	-8.42	164.27	15.05	140.45	-65.05	-29.66	-0.31	176.88
3.2	-8.62	161.29	12.44	128.26	-67.98	44.67	-0.26	173.94
3.3	-8.79	158.64	9.75	116.69	-66.94	56.68	-0.23	171.25
3.4	-8.93	156.09	6.99	105.56	-65.82	46.96	-0.21	168.65
3.5	-9.03	153.75	3.97	94.82	-67.24	-32.48	-0.19	166.15
3.6	-9.12	151.35	0.44	84.83	-66.22	80.49	-0.18	163.60
3.7	-9.19	149.35	-4.16	77.06	-68.40	16.02	-0.19	161.14
3.8	-9.23	147.53	-11.49	83.61	-64.92	94.39	-0.19	158.71
3.9	-9.24	146.05	-15.57	-1.69	-65.83	51.09	-0.20	156.25
4.0	-9.16	144.81	-8.70	-35.16	-62.72	67.81	-0.23	153.69
4.1	-9.01	143.67	-3.80	170.21	-64.35	63.03	-0.26	151.25
4.2	-8.77	142.00	-0.97	148.25	-60.54	50.84	-0.31	148.89

S-Parameter^[5] (Vdd = VddBias = 5.0 V, Vc1 = 2.4 V, Vc2 = 1.6 V, Vc3 = 2.2 V, TA = 25° C, 50ohm), continued

Freq (GHz)	S11 (dB)	S11 (ang)	S21 (dB)	S21 (ang)	S12 (dB)	S12 (ang)	S22 (dB)	S22 (ang)
4.3	-8.63	139.37	0.00	117.18	-60.96	33.65	-0.39	146.77
4.4	-8.73	138.13	-1.86	82.59	-61.12	41.98	-0.42	145.05
4.5	-8.63	139.55	-7.11	57.81	-60.99	35.39	-0.39	143.24
4.6	-8.00	141.12	-14.73	75.62	-64.30	-0.11	-0.36	141.15
4.7	-7.06	140.09	-12.06	116.77	-63.38	52.25	-0.34	138.99
4.8	-6.14	136.11	-8.35	108.34	-63.94	51.05	-0.33	136.93
4.9	-5.49	129.96	-6.96	88.89	-61.63	15.61	-0.33	135.04
5.0	-5.15	123.56	-6.93	67.14	-64.21	11.62	-0.34	132.96
5.1	-5.15	118.26	-8.09	42.27	-61.39	30.39	-0.36	130.76
5.2	-5.38	115.24	-12.24	20.44	-63.82	37.09	-0.35	129.09
5.3	-5.20	111.70	-15.65	31.78	-61.86	41.29	-0.34	127.50
5.4	-5.31	107.33	-17.07	28.94	-62.86	45.83	-0.35	126.09
5.5	-5.44	104.12	-19.23	42.79	-63.68	31.55	-0.33	124.79
5.6	-5.47	100.09	-15.63	59.85	-63.14	25.77	-0.33	123.57
5.7	-5.93	95.36	-12.43	29.97	-64.74	-0.40	-0.32	122.56
5.8	-6.49	93.92	-13.43	1.76	-63.65	43.77	-0.31	121.60
5.9	-6.85	93.51	-15.03	-16.43	-63.91	30.65	-0.30	120.59
6.0	-7.11	93.13	-16.18	-30.70	-62.57	28.50	-0.29	119.75
7.0	-8.31	93.81	-25.85	91.56	-61.89	35.51	-0.19	113.46
8.0	-8.99	89.60	-27.22	44.19	-58.70	26.63	-0.28	97.34
9.0	-10.05	67.30	-29.18	-3.94	-55.56	0.62	-0.36	70.05
10.0	-9.22	47.21	-31.93	-41.22	-57.23	-15.48	-0.18	49.73
11.0	-7.02	50.16	-34.57	-71.69	-59.39	-20.92	-0.59	30.91
12.0	-7.25	44.19	-36.85	-96.94	-57.36	-39.60	-1.55	13.59
13.0	-11.42	33.20	-37.80	-130.84	-57.77	-29.55	-0.08	-11.14
14.0	-10.76	1.42	-38.32	-173.87	-54.03	-26.41	-0.42	-36.80
15.0	-9.44	-38.08	-41.32	128.69	-47.98	-33.03	-0.59	-51.91
16.0	-10.44	-116.93	-41.46	33.62	-44.76	-58.79	-0.63	-61.94
17.0	-8.09	125.59	-39.66	-72.54	-40.64	-96.96	-0.58	-70.62
18.0	-4.68	71.47	-45.58	-129.22	-44.72	-136.92	-0.46	-81.73
19.0	-3.84	41.22	-47.82	-144.14	-47.25	-140.61	-0.40	-91.57
20.0	-4.71	5.60	-45.55	-128.30	-42.88	-131.48	-0.55	-102.61

S-Parameter^[5] (Vdd = VddBias = 5.5 V, Vc1 = 2.4 V, Vc2 = 1.6 V, Vc3 = 2.2 V, TA = 25° C, 50ohm)

Freq (GHz)	S11 (dB)	S11 (ang)	S21 (dB)	S21 (ang)	S12 (dB)	S12 (ang)	S22 (dB)	S22 (ang)
0.1	-0.29	175.00	-59.13	53.94	-54.17	-51.13	-0.55	175.32
0.2	-0.35	164.39	-52.00	-67.58	-61.93	-4.25	-0.88	173.48
0.3	-0.39	154.95	-44.30	-73.44	-61.17	25.89	-1.07	172.31
0.4	-0.38	145.31	-28.19	-65.50	-62.11	-1.81	-1.18	171.50
0.5	-0.95	135.10	-14.60	-163.35	-63.80	0.21	-1.22	171.42
0.6	-0.73	125.24	-15.28	-100.32	-63.69	144.82	-0.94	167.60
0.7	-0.74	109.90	3.29	-116.04	-64.98	94.53	-1.38	165.96
0.8	-2.45	80.34	18.98	103.41	-65.62	77.81	-1.60	165.47
0.9	-5.64	100.04	21.57	63.89	-66.07	71.12	-1.82	165.61
1.0	-3.72	82.61	12.93	18.44	-64.05	77.11	-1.56	166.94
1.1	-4.05	48.45	24.05	81.53	-66.96	33.57	-2.46	166.68
1.2	-15.24	24.79	34.58	25.03	-63.67	103.84	-0.99	166.08
1.3	-11.04	59.95	36.75	-46.85	-64.92	100.47	-0.51	161.00
1.4	-10.22	33.58	37.18	-93.55	-61.17	96.39	-0.46	154.81
1.5	-10.87	3.51	37.69	-130.50	-60.08	89.89	-0.67	148.74
1.6	-11.39	-29.72	38.41	-163.70	-58.91	93.27	-1.13	142.28
1.7	-11.18	-66.47	39.21	163.61	-58.71	87.79	-1.97	136.01
1.8	-10.97	-98.68	40.09	130.92	-56.45	82.16	-3.14	129.48
1.9	-11.21	-125.81	40.85	96.09	-54.29	69.54	-5.02	123.03
2.0	-13.12	-142.38	41.11	59.18	-53.68	57.14	-7.86	119.02
2.1	-15.16	-132.37	40.74	20.77	-52.35	41.28	-12.99	118.88
2.2	-11.88	-115.08	39.91	-12.30	-51.99	20.58	-22.19	-81.64
2.3	-8.15	-127.35	38.83	-53.32	-52.95	1.96	-8.48	-123.43
2.4	-6.65	-145.31	36.07	-90.57	-54.08	-15.77	-4.08	-138.45
2.5	-6.43	-160.23	32.70	-119.74	-55.17	-28.59	-2.25	-151.01
2.6	-6.64	-170.77	29.39	-142.69	-59.92	-42.79	-1.38	-160.16
2.7	-7.03	-106.67	26.23	-162.29	-59.60	-39.99	-0.92	-166.99
2.8	-7.45	175.50	23.23	-107.13	-62.52	-45.10	-0.67	-172.20
2.9	-7.79	171.07	20.38	165.96	-61.92	-33.21	-0.50	-176.43
3.0	-8.08	167.41	17.67	152.25	-66.53	-14.36	-0.39	-36.04
3.1	-8.32	164.27	15.03	139.59	-66.73	-61.70	-0.31	176.81
3.2	-8.51	161.24	12.41	127.46	-67.40	-33.90	-0.26	173.89
3.3	-8.68	158.61	9.73	115.94	-66.40	56.83	-0.23	171.20
3.4	-8.80	156.09	6.97	104.85	-68.41	52.44	-0.22	168.60
3.5	-8.89	153.71	3.94	94.15	-67.97	-1.70	-0.19	166.11
3.6	-8.98	151.23	0.40	84.19	-65.80	-28.66	-0.18	163.54
3.7	-9.04	149.19	-4.21	76.52	-67.70	8.32	-0.19	161.10
3.8	-9.07	147.35	-11.55	83.46	-66.16	44.47	-0.19	158.64
3.9	-9.07	145.84	-15.48	-1.64	-62.34	101.92	-0.20	156.17
4.0	-9.00	144.52	-8.63	36.00	-66.96	61.84	-0.22	153.64
4.1	-8.83	143.24	-3.77	169.25	-62.86	73.11	-0.25	151.19
4.2	-8.60	141.45	-0.97	147.17	-62.59	42.78	-0.31	148.83

S-Parameter^[5] (Vdd = VddBias = 5.5 V, Vc1 = 2.4 V, Vc2 = 1.6 V, Vc3 = 2.2 V, TA = 25° C, 50ohm) continued

Freq (GHz)	S11 (dB)	S11 (ang)	S21 (dB)	S21 (ang)	S12 (dB)	S12 (ang)	S22 (dB)	S22 (ang)
4.3	-8.47	138.73	-0.05	116.04	-60.02	41.20	-0.38	146.72
4.4	-8.58	137.44	-1.99	81.68	-60.51	14.80	-0.40	145.00
4.5	-8.49	138.69	-7.28	57.51	-61.97	18.14	-0.38	143.17
4.6	-7.89	140.10	-14.78	76.52	-65.41	43.49	-0.34	141.04
4.7	-6.99	139.03	-11.98	116.38	-63.72	52.82	-0.33	138.90
4.8	-6.11	135.16	-8.34	107.69	-62.39	36.90	-0.31	136.85
4.9	-5.49	129.19	-6.98	88.27	-61.97	40.51	-0.30	134.96
5.0	-5.15	123.03	-6.97	66.51	-62.93	34.28	-0.32	132.89
5.1	-5.16	117.93	-8.15	41.56	-63.10	32.09	-0.33	130.68
5.2	-5.37	115.08	-12.41	20.17	-62.46	45.10	-0.32	129.01
5.3	-5.19	111.51	-15.67	31.89	-61.14	41.14	-0.32	127.41
5.4	-5.30	107.26	-17.14	29.01	-63.03	38.26	-0.32	126.03
5.5	-5.41	104.10	-19.21	43.42	-61.06	30.74	-0.31	124.71
5.6	-5.43	100.03	-15.47	59.16	-62.20	10.54	-0.30	123.49
5.7	-5.89	95.45	-12.44	28.99	-62.44	33.84	-0.30	122.48
5.8	-6.43	94.02	-13.48	1.22	-64.78	57.64	-0.28	121.52
5.9	-6.77	93.62	-15.07	-16.78	-63.66	30.94	-0.28	120.51
6.0	-7.01	93.20	-16.20	-31.04	-64.00	47.41	-0.27	119.66
7.0	-8.18	93.27	-25.88	91.47	-59.95	50.54	-0.18	113.38
8.0	-8.89	88.46	-27.26	44.60	-57.94	34.92	-0.28	97.21
9.0	-10.00	65.66	-29.14	-3.68	-55.93	3.04	-0.37	69.88
10.0	-9.25	45.56	-31.82	-41.17	-58.35	-23.54	-0.17	49.51
11.0	-7.15	48.91	-34.52	-72.20	-57.79	-19.00	-0.57	30.67
12.0	-7.48	43.14	-36.79	-97.15	-58.73	-33.66	-1.54	13.34
13.0	-11.85	32.74	-37.74	-130.74	-54.91	-27.79	-0.09	-11.44
14.0	-11.17	1.06	-38.45	-172.97	-54.05	-29.57	-0.42	-37.14
15.0	-9.80	-38.75	-41.52	129.09	-47.98	-32.68	-0.59	-52.23
16.0	-10.70	-119.43	-41.53	33.60	-44.08	-59.74	-0.61	-62.26
17.0	-7.95	124.07	-39.52	-72.70	-40.66	-96.97	-0.56	-70.91
18.0	-4.58	70.71	-45.94	-132.50	-44.68	-134.82	-0.46	-82.04
19.0	-3.82	40.60	-47.04	-144.31	-47.32	-138.16	-0.42	-91.85
20.0	-4.71	4.74	-46.00	-129.98	-42.95	-132.97	-0.56	-102.95

Notes:

5. S-parameter is measured with deembedded reference plane at DUT RFin and RFout pins.

Demonstration Board Top View (Vdd=VddBias=5.0V, Vdd=VddBias=5.5V operating voltage)

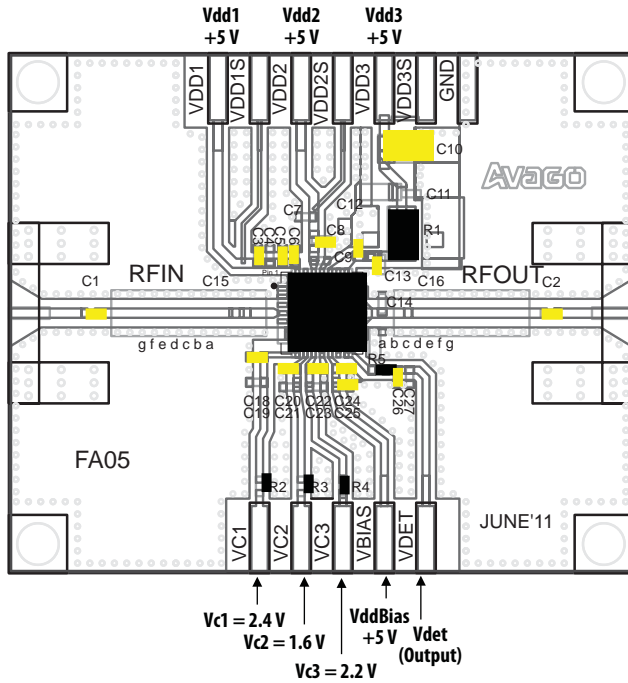

Vdd1 +5V, Vdd2 +5V, Vdd3 +5V

VC1 = 2.4 V, VC2 = 1.6 V, VddBias +5V, Vdet (Output), VC3 = 2.2 V

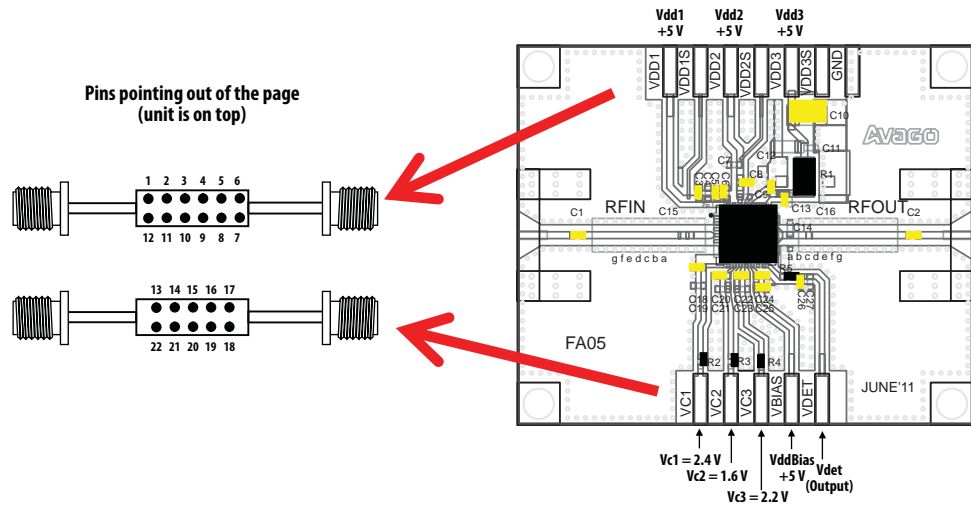

Figure 30. Demonstration board application circuit for MGA-43628 module

Application Schematic

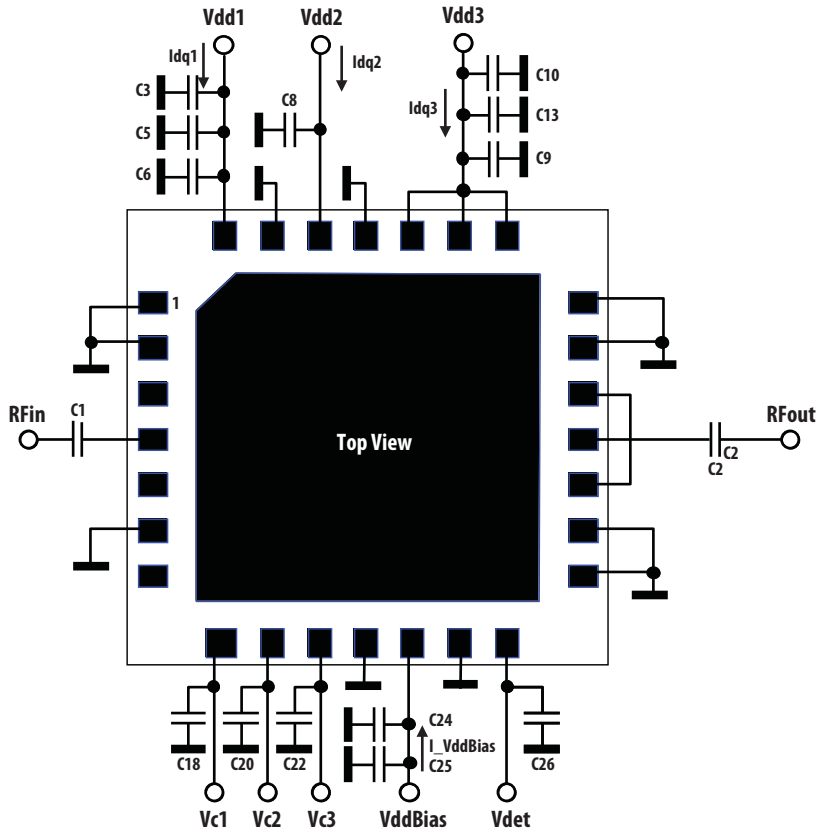

Figure 31. Application schematic in demonstration board

Notes:

1. All capacitors on supply lines are bypass capacitors
2. C1 / C2 are RF coupling capacitors.
3. Idq1 = 60.0 mA, Idq2 = 110 mA, Idq3 = 270.0 mA, I_VddBias = 14.0 mA. Idq1/2/3 are adjusted by voltages to CMOS-compatible control pins Vc1/2/3 respectively. These typical bias currents were obtained with Vc1/2/3 voltages in Figure 30 above. Adjustment of these currents enable optimum bias conditions to be achieved for best linearity and efficiency for a given modulation type

MGA-43628 typical I_{c1} , I_{c2} , I_{c3} Vs V_c performance unless otherwise stated

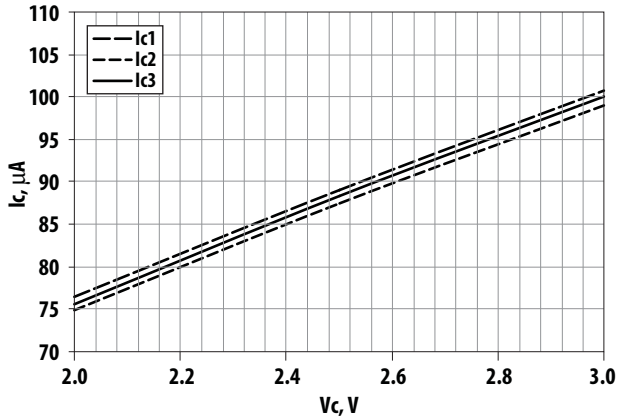

Figure 32. I_c Versus V_c at $V_{dd} = V_{ddBias} = 5.0$ V

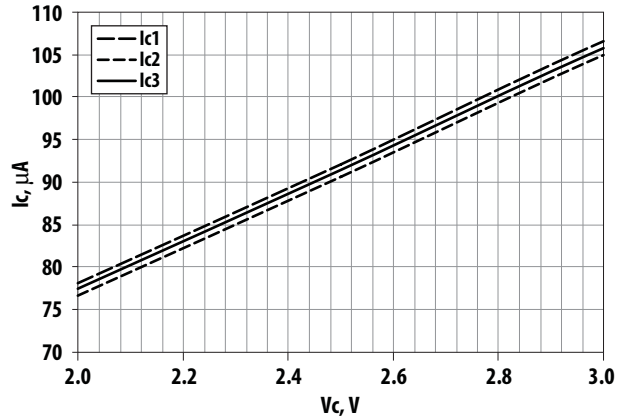
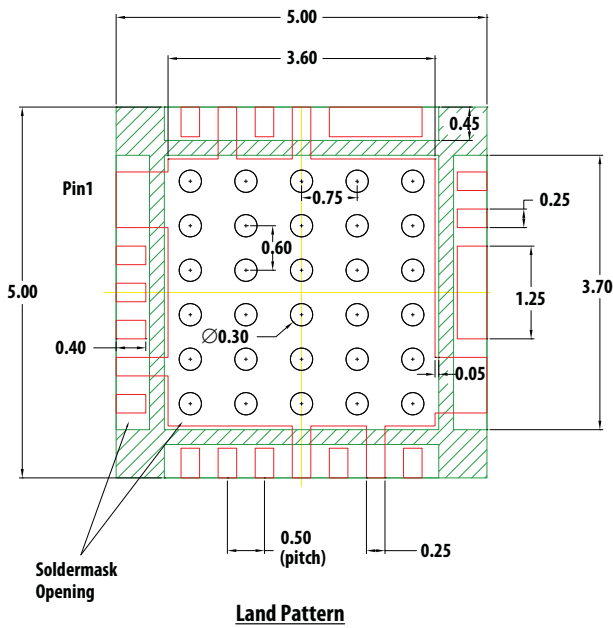
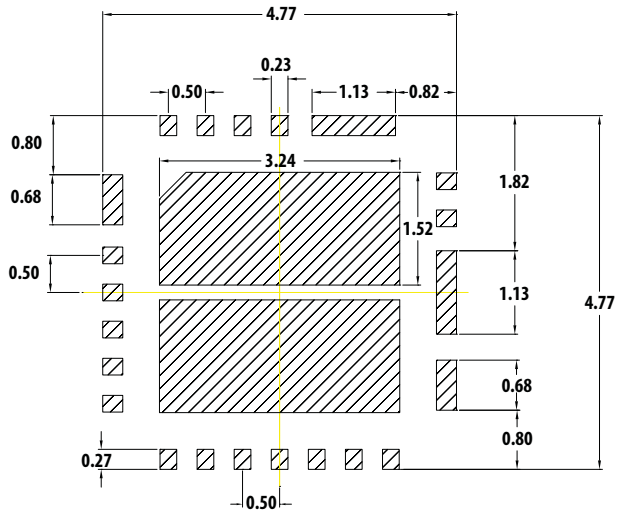

Figure 33. I_c Versus V_c at $V_{dd} = V_{ddBias} = 5.5$ V

PCB Land Pattern and Stencil Outline



Land Pattern



Stencil Opening

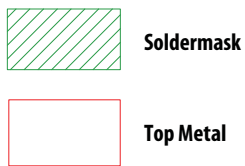

Note :

1. Recommended Land Pattern and Stencil.
2. 4 mils stencil thickness recommended.
3. All dimensions are in mm

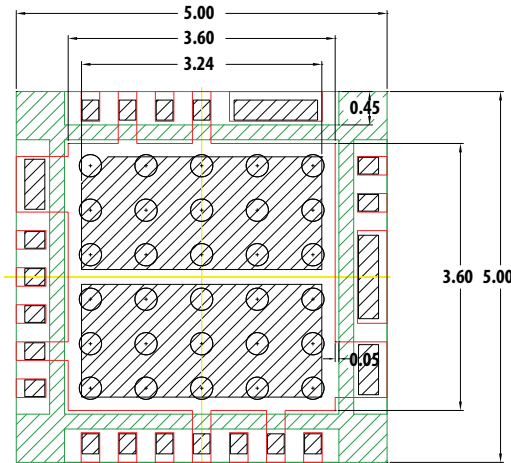

Combination of Land Pattern & Stencil Opening

MCOB (5.0 x 5.0 x 0.9) mm 28-Lead Package Dimensions

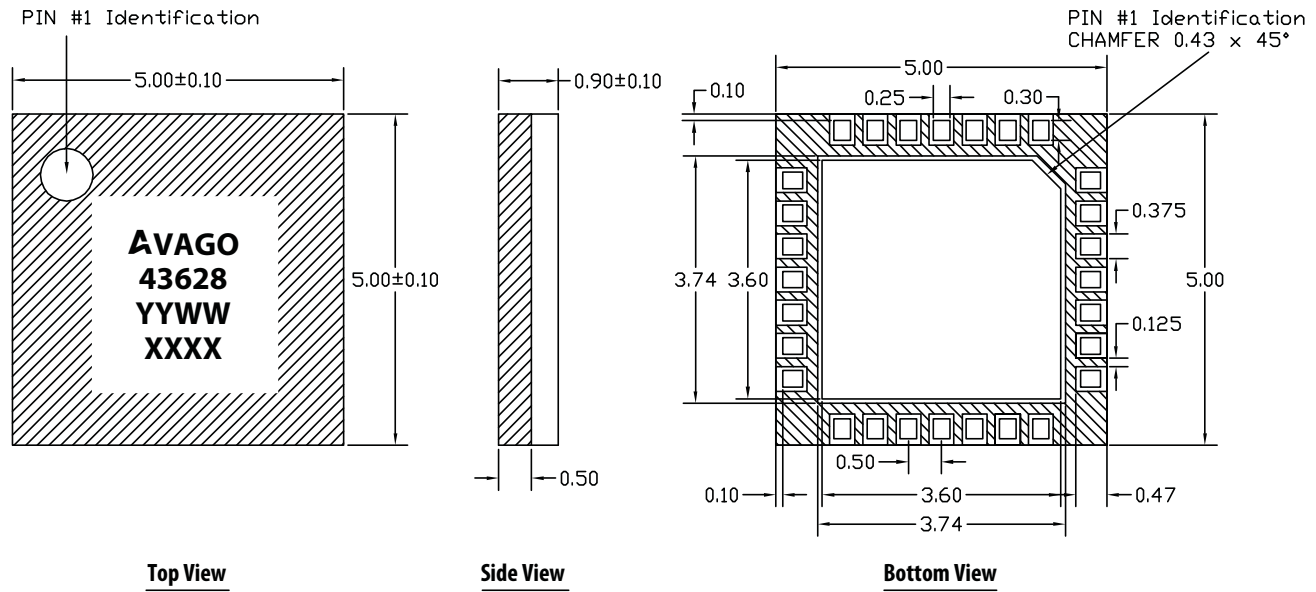

Note

1. All dimensions are in millimeters.
2. Dimensions are inclusive of plating.
3. Dimensions are exclusive of mold flash and metal burr.

Part Number Ordering Information

Part Number	Qty	Container
MGA-43628-BLKG	100	Antistatic Bag
MGA-43628-TR1G	1000	7" Reel

Device Orientation

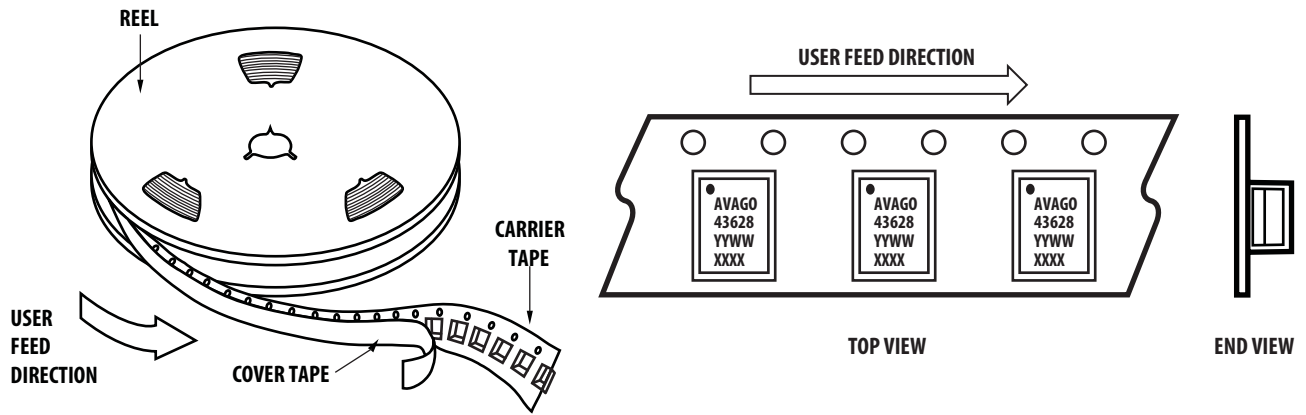

Tape Dimensions

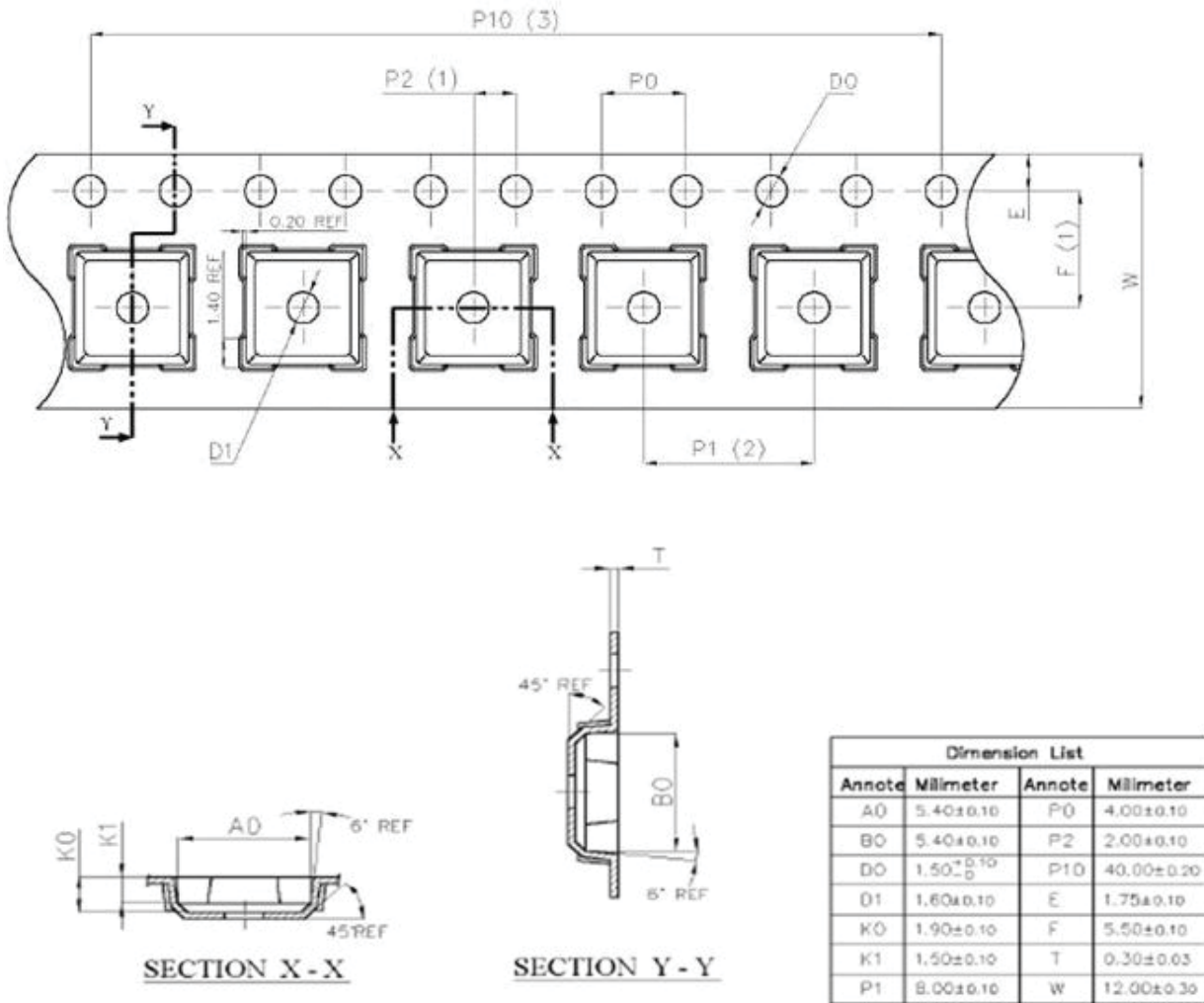

Reel Dimensions (7" reel)

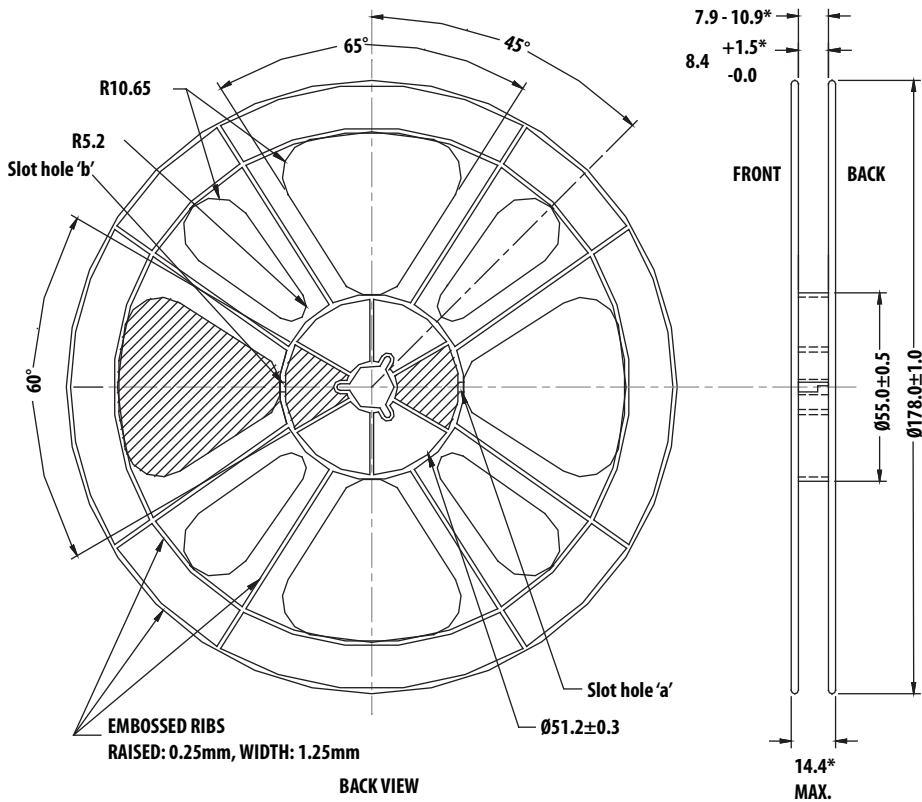
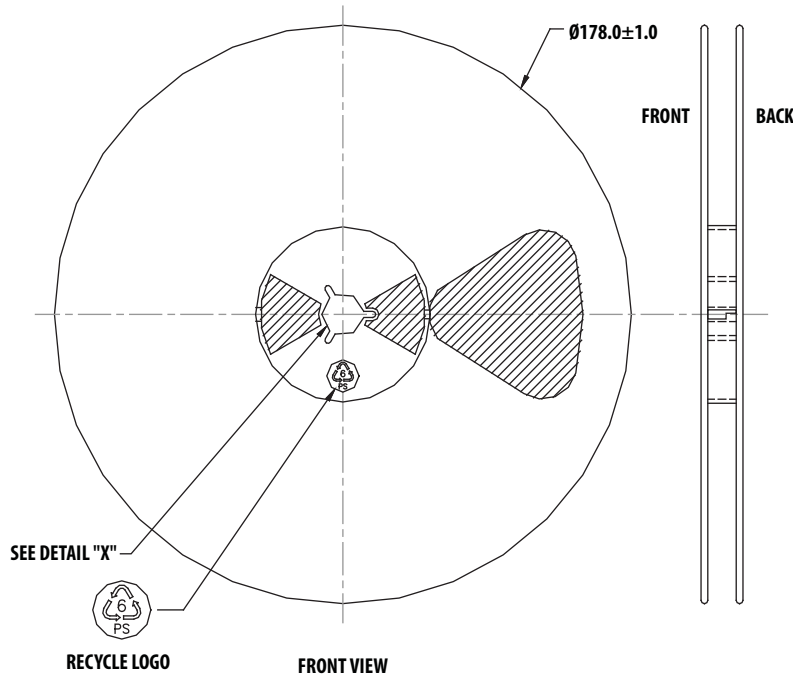

For product information and a complete list of distributors, please go to our web site: www.avagotech.com

Avago, Avago Technologies, and the A logo are trademarks of Avago Technologies in the United States and other countries. Data subject to change. Copyright © 2005-2012 Avago Technologies. All rights reserved. AV02-3741EN - October 31, 2012

